COMPENDIUM OF

INTERNATIONAL METHODS

OF WINE AND MUST ANALYSIS



**INTERNATIONAL ORGANISATION
OF VINE AND WINE**

***COMPENDIUM
OF INTERNATIONAL
METHODS OF WINE
AND MUST ANALYSIS***

EDITION 2024

VOLUME 1



INCLUDED :

***Resolutions adopted in the 21st General Assembly
9th June 2023 – Jerez (Spain)***

Printed in Dijon (France)

12, Parvis de l'UNESCO

21000 Dijon, France

Legal Deposit : January 2024

ISBN : 978-2-85038-096-9

ISBN Volume I : 978-2-85038-096-9

COMPENDIUM OF INTERNATIONAL METHODS OF ANALYSIS-OIV
Table of contents

General organization of the Compendium

Table of contents

Foreword

ANNEX A – METHODS OF ANALYSIS OF WINES AND MUSTS

SECTION 1 – DEFINITIONS AND GENERAL PRINCIPLES

SECTION 2 – PHYSICAL ANALYSIS

SECTION 3 – CHIMICAL ANALYSIS

SECTION 3.1 – ORGANIC COMPOUNDS

SECTION 3.1.1 – SUGARS

SECTION 3.1.2 – ALCOHOLS

SECTION 3.1.3 – ACIDS

SECTION 3.1.4 – GAS

SECTION 3.1.5 – OTHER ORGANIC COMPOUNDS

SECTION 3.1.6 – MIXED ORGANIC COMPOUNDS

SECTION 3.2 – NON ORGANIC COMPOUNDS

SECTION 3.2.1 – ANIONS

SECTION 3.2.2 – CATIONS

SECTION 3.2.3 – OTHER NON ORGANIC COMPOUNDS

SECTION 4 – MICROBIOLOGICAL ANALYSIS

SECTION 5 – OTHER ANALYSIS

ANNEX B - CERTIFICATES OF ANALYSIS

ANNEX C - MAXIMUM ACCEPTABLE LIMITS OF VARIOUS SUBSTANCES

ANNEX D – ADVICES

ANNEX E – LABORATORY QUALITY ASSURANCE

COMPENDIUM OF INTERNATIONAL METHODS OF ANALYSIS-OIV
Table of contents

**ANNEX F – SPECIFIC METHODS FOR THE ANALYSIS OF GRAPE SUGAR
(RECTIFIED CONCENTRATED MUSTS)**

**ANNEXE G - GRAPE JUICE, RECONSTITUTED GRAPE JUICE, CONCENTRATED
GRAPE JUICE, AND GRAPE NECTAR**

NB: Each method has its references into the brackets (referred resolutions, reference methods of the “Recueil des méthodes internationales d’analyse des vins et des moûts” 1990 = Compendium OIV ed. 1990; methods of the “Recueil des méthodes internationales d’analyse des vins” 1978 = A number i.e. A1, A2 ...)

Title	Reference	Type method
- Table of contents	OIV-MA-INT-00	
VOLUME 1		
- Foreword	OIV-MA-INT-01	
- Layout and wording of OIV method of analysis	OIV-MA-INT-04	
ANNEX A – METHODS OF ANALYSIS OF WINES AND MUSTS		
SECTION 1 – DEFINITIONS AND GENERAL PRINCIPLES		
- General remarks	OIV-MA-AS1-02	
- Classification of analytical methods (OENO 9/2000)	OIV-MA-AS1-03	
- Matrix effect for metals content analysis (OENO 5/2000)	OIV-MA-AS1-04	
- Provisions on the use of proprietary methods that should be adopted by the OIV (OIV-OENO 526-2016)	OIV-MA-AS1-05A	
SECTION 2 – PHYSICAL ANALYSIS		
- Density and Specific Gravity at 20°C (A 1 revised by OIV-OENO 601A-2021)	OIV-MA-AS2-01	I and IV
- Evaluation by refractometry of the sugar concentration in grape, musts, concentrated grape musts and rectified concentrated grape musts (Recueil OIV ed. 1990 revised by OIV/OENO 377/2009)	OIV-MA-AS2-02	I
- Total dry matter (gravimétrie) (A 3 revised by OIV/OENO 377/2009, OIV/OENO 387/2009, OIV-OENO 465-2012)	OIV-MA-AS2-03A	I
- Total dry matter (densimétrie) (OIV/OENO 377/2009, OIV-OENO 387/2009, OIV-OENO 465-2012)	OIV-MA-AS2-03B	IV
- Ash (A 6 revised by OIV/OENO 377/2009)	OIV-MA-AS2-04	I
- Alkalinity of Ash (A 7 revised by OIV/OENO 377/2009)	OIV-MA-AS2-05	IV
- Oxidation-reduction potential (OENO 3/2000)	OIV-MA-AS2-06	IV
- Chromatic Characteristics (A0 mod.)	OIV-MA-AS2-07A	Withdrawn
- Chromatic Characteristics (A0 revised by OIV/OENO 377/2009, OIV-OENO 667-2022)	OIV-MA-AS2-07B	IV
- Wine turbidity (Oeno 4/2000 revised by OIV/OENO 377/2009)	OIV-MA-AS2-08	IV

COMPENDIUM OF INTERNATIONAL METHODS OF ANALYSIS-OIV
Table of contents

- Method for isotopic ratio ¹⁸ O/ ¹⁶ O (OENO 2/96)	OIV-MA-AS2-09	Withdrawn
- Folin-Ciocalteu Index (Recueil OIV ed. 1990 revised by OIV/OENO 377/2009)	OIV-MA-AS2-10	IV
- Chromatic Characteristics (OENO 1/2006; OIV/OENO 377/2009)	OIV-MA-AS2-11	I
- Method for ¹⁸ O/ ¹⁶ O isotope ratio determination of water in wines and must (OIV/OENO 353/2009)	OIV-MA-AS2-12	II
- Method for the determination of the size of pieces of oak wood by screening (OIV-OENO 406-2011)	OIV-MA-AS2-13	I

SECTION 3 – CHIMICAL ANALYSIS

SECTION 3.1 – ORGANIC COMPOUNDS

SECTION 3.1.1 – SUGARS

- Reducing substances (A 4 revised by OIV/OENO 377/2009)	OIV-MA-AS311-01A	IV
- Reducing sugars (clarification) (type IV)	OIV-MA-AS311-01B	Withdrawn
- Reducing sugars (titrimétrie) (type II)	OIV-MA-AS311-01C	Withdrawn
- Glucose and fructose (enzymatic method) (revised by OIV/OENO 377/2009)	OIV-MA-AS311-02	II
- Dosage of sugars by HPLC (OENO 23/2003; OIV/OENO 377/2009, OIV-OENO 552-2016)	OIV-MA-AS311-03	II
- Stabilisation of musts to detect Addition of sucrose (A 5)	OIV-MA-AS311-04	
- Determination of the deuterium distribution in ethanol derived from fermentation of grape musts, concentrated grape musts, rectified concentrated grape musts and wines by application of nuclear magnetic resonance (SNIFNMR/RMNFINS) (OIV-OENO 426-2011)	OIV-MA-AS311-05	II
- Polyols derived from sugars (OENO 9/2006)	OIV-MA-AS311-06	IV
- Glucose and fructose (pHmetry) (OENO 10/2006 revised by OIV/OENO377/2009)	OIV-MA-AS311-07	III
- Glucose, fructose and saccharose (pHmetry) (OENO 11/2006 revised by OIV/OENO 377/2009)	OIV-MA-AS311-08	IV
- Determination of the ¹³ C/ ¹² C isotope ratios of glucose, fructose, glycerol, ethanol in production of vitivinicultural origin by high-performance liquid chromatography coupled to isotope ratio mass spectrometry (OIV-OENO 479-2017)	OIV-MA-AS311-09	II and III
- Determination of D-glucose and D-fructose in wines by automated enzymatic method (OIV-OENO 600-2018)	OIV-MA-AS311-10	III

SECTION 3.1.2 – ALCOHOLS

- Alcoholic strength by volume (A2; OENO 8/2000; OENO 24/2003; revised by OIV/OENO 377/2009; revised by OIV-OENO 601B-2021)	OIV-MA-AS312-01	I and IV
- Tables of correction (A2)	OIV-MA-AS312-02	
- Methanol (GC) (A 41 OIV/OENO 377/2009, OIV-OENO 480-2014)	OIV-MA-AS312-03A	IV
- Methanol (colorimetry) (A 41 revised by OIV/OENO	OIV-MA-AS312-03B	IV

COMPENDIUM OF INTERNATIONAL METHODS OF ANALYSIS-OIV
Table of contents

377/2009)		
- Glycerol and 2,3- butanediol (A 21 revised by OIV/OENO 377/2009)	OIV-MA-AS312-04	IV
- Glycerol (enzymatic method) (Recueil OIV ed. 1990 revised by OIV/OENO 377/2009)	OIV-MA-AS312-05	IV
- Determination of isotopic ratio of ethanol (OENO 17/2001)	OIV-MA-AS312-06	II
- Glycerol (GC-C-IRMS or HPLC-IRMS method) (OIV/OENO 343/2010)	OIV-MA-AS312-07	IV
 <i>SECTION 3.1.3 – ACIDS</i>		
- Total Acidity (revised by OIV-OENO 551-2015)	OIV-MA-AS313-01	I
- Volatile Acidity (revised by OIV-OENO 549-2015)	OIV-MA-AS313-02	I
- Fixed Acidity (A 11 revised by OIV/OENO 377/2009)	OIV-MA-AS313-03	I
- Organic Acids : HPLC (Recueil OIV ed. 1990 revised by OIV/OENO 377/2009)	OIV-MA-AS313-04	IV
- Tartaric Acid (gravimetry) (A 12 revised by OIV/OENO 377/2009)	OIV-MA-AS313-05A	IV
- Tartaric Acid (colorimetry) (A 12)	OIV-MA-AS313-05B	Withdrawn
- Lactic Acid – chemical method (A 27)	OIV-MA-AS313-06	Withdrawn
- Lactic Acid – enzymatic method (Recueil OIV ed. 1990 revised by OIV/OENO 377/2009)	OIV-MA-AS313-07	II
- Citric Acid - chemical method (A 29)	OIV-MA-AS313-08	IV
- Citric Acid - enzymatic method (Recueil OIV ed. 1990 revised by OIV/OENO 377/2009)	OIV-MA-AS313-09	II
- Total malic Acid: usual method (A 33 revised by OIV/OENO 377/2009)	OIV-MA-AS313-10	IV
- L-malic Acid: enzymatic method (Recueil OIV ed. 1990 revised by OIV/OENO 377/2009)	OIV-MA-AS313-11	II
- D-malic Acid: enzymatic method (OENO 6/98 revised by OIV/OENO 377/2009)	OIV-MA-AS313-12A	II
- D-malic Acid: enzymatic method low concentrations (OENO 16/2002 revised by OIV/OENO 377/2009)	OIV-MA-AS313-12B	IV
- L-ascorbic Acid (spectrofluorimetry) (A 28 revised by OIV/OENO 377/2009)	OIV-MA-AS313-13A	IV
- L-ascorbic Acid (spectrophotometry) (A 28; OIV/OENO 377/2009)	OIV-MA-AS313-13B	Withdrawn
- Sorbic Acid (spectrophotometry) (A 30 revised by OIV/OENO 377/2009)	OIV-MA-AS313-14A	IV
- Sorbic Acid (GC) (A 30 revised by OIV/OENO 377/2009)	OIV-MA-AS313-14B	IV
- Sorbic Acid (TLC) (A 30 revised by OIV/OENO 377/2009)	OIV-MA-AS313-14C	IV
- pH (A31 revised by OIV-OENO 438-2011)	OIV-MA-AS313-15	I
- Organic acid : ionic chromatography (OENO 23/2004; OIV/OENO 377/2009)	OIV-MA-AS313-16	IV
- Shikimic acid (OENO 33/2004; OIV/OENO 377/2009)	OIV-MA-AS313-17	II
- Sorbic acid (capillary electrophoresis) (OENO 4/2006;	OIV-MA-AS313-18	IV

COMPENDIUM OF INTERNATIONAL METHODS OF ANALYSIS-OIV
Table of contents

OIV/OENO 377/2009)		
- Organic acids and sulphates (capillary electrophoresis) (OENO 5/2006, extended by OIV-OENO 407-2011)	OIV-MA-AS313-19	II
- Sorbic, benzoic, salicylic acids (OENO 6/2006; OIV/OENO 377/2009; OIV-OENO 687-2023)	OIV-MA-AS313-20	IV
- Metatartaric acid (OENO 10/2007; OIV/OENO 337/2009)	OIV-MA-AS313-21	IV
- Determination of L-ascorbic acid and D-iso-ascorbic acid by HPLC (OENO 11/2008)	OIV-MA-AS313-22	II
- Identification of L- tartaric acid (OENO 12/2008)	OIV-MA-AS313-23	IV
- Determination of total ethanol in wine by high-performance liquid chromatography (OIV-OENO 595-2018)	OIV-MA-AS313-24	IV
- Determination of L-Lactic acid in wines by automated enzymatic method (OIV-OENO 599-2018)	OIV-MA-AS313-25	IV
- Determination of L-malic acid in wine by automated enzymatic method (OIV-OENO 599-2018)	OIV-MA-AS313-26	III
- Determination of acetic acid in wines by automated enzymatic method (OIV-OENO 621-2019)	OIV-MA-AS313-27	II
- Determination of D-gluconic acid in wines and musts by automated enzymatic method (OIV-OENO 622-2019)	OIV-MA-AS313-28	II
 <i>SECTION 3.1.4 – GAS</i>		
- Carbone Dioxide (A 39 modified by OENO 21/2003 and completed by OENO 3/2006 revised by OIV/OENO 377/2009)	OIV-MA-AS314-01	II
- Overpressure measurement of sparkling wines (OENO 21/2003; OIV/OENO 377/2009)	OIV-MA-AS314-02	I
- Determination of the carbon isotope ratio ¹³ C/ ¹² C of CO ₂ in sparkling wines (OENO 7/2005; OIV/OENO 377/2009; OIV-OENO 512-2014)	OIV-MA-AS314-03	II
- Carbone dioxyde (manometric method) (OENO 2/2006)	OIV-MA-AS314-04	II
 VOLUME 2		
 <i>SECTION 3.1.5 – OTHER ORGANIC COMPOUNDS</i>		
- Acetaldehyde (ethanal) (A 37 revised by OIV/OENO 377/2009)	OIV-MA-AS315-01	IV
- Ethyl Acetate (GC) (Recueil OIV ed. 1990 revised by OIV/OENO 377/2009)	OIV-MA-AS315-02A	IV
- Ethyl Acetate (titrimetry) (revised by OIV/OENO 377/2009)	OIV-MA-AS315-02B	IV
- Malvidin Diglucoside (A 18 revised by OIV/OENO 377/2009)	OIV-MA-AS315-03	IV
- Ethyl Carbamate (OENO 8/98 revised by OIV/OENO 377/2009)	OIV-MA-AS315-04	II
- Hydroxymethylfurfural (colorimetry) (A 19 revised by OIV/OENO 377/2009)	OIV-MA-AS315-05A	IV
- Hydroxymethylfurfural (HPLC) (A 19 revised by OIV/OENO 377/2009)	OIV-MA-AS315-05B	IV

COMPENDIUM OF INTERNATIONAL METHODS OF ANALYSIS-OIV
Table of contents

- Cyanide Derivatives (OENO 4/94 revised by OIV/OENO 377/2009)	OIV-MA-AS315-06	II
- Artificial sweeteners (TLC : saccharine, cyclamate, Dulcin and P-4000) (A 36 revised by OIV/OENO 377/2009)	OIV-MA-AS315-07A	IV
- Artificial sweeteners (TLC: saccharine, cyclamate and Dulcin) (A 36 revised by OIV/OENO 377/2009)	OIV-MA-AS315-07B	IV
- Artificial Colorants (A 43 revised by OIV/OENO 377/2009)	OIV-MA-AS315-08	IV
- Diethylene glycol (Recueil OIV ed. 1990 revised by OIV/OENO 377/2009)	OIV-MA-AS315-09	IV
- Ochratoxin A (OENO 16/2001 revised by OIV-OENO 349-2011)	OIV-MA-AS315-10	II
- HPLC-Determination of nine major Anthocyanins in red and rosé wines (OENO 22/2003; OENO 12/2007; OIV/OENO 377/2009)	OIV-MA-AS315-11	II
- Plant proteins (OENO 24/2004 ; OIV/OENO 377/2009)	OIV-MA-AS315-12	IV
- Polychlorophenols, polychloroanisols (OENO 8/2006)	OIV-MA-AS315-13	Withdrawn
- Determination of Lysozyme by HPLC (OENO 8/2007; OIV/OENO 377/2009)	OIV-MA-AS315-14	IV
- Determination of 3-Methoxypropane-1,2-diol and Cyclic Diglycerols (OENO 11/2007; OIV/OENO 377/2009)	OIV-MA-AS315-15	II
- Determination of releasable 2,4,6-trichloroanisole in wine (OIV/OENO 296/2009, OIV-OENO 623-2018)	OIV-MA-AS315-16	IV
- Determining the presence and content of polychlorophenols and polychloroanisols in wines, cork stoppers, wood and bentonites used as atmospheric traps (OIV/OENO 374/2009)	OIV-MA-AS315-17	IV
- Analysis of biogenic amines in musts and wines HPLC (OIV/OENO 346/2009)	OIV-MA-AS315-18	II
- Determination of glutathione (OIV/OENO 345/2009)	OIV-MA-AS315-19	IV
- Determination of α -dicarbonyl compounds of wine by HPLC after derivatization (OIV/OENO 386A/2010)	OIV-MA-AS315-20	IV
- Determination of α -dicarbonyl compounds of wine by GC after derivatization (OIV/OENO 386B/2010)	OIV-MA-AS315-21	IV
- Determination of carboxymethyl cellulose in white wines (OIV/OENO 404/2010)	OIV-MA-AS315-22	IV
- Quantification of potentially allergenic residues of fining agent proteins in wine (OIV/OENO 427/2010; OIV-COMEX 502-2012))	OIV-MA-AS315-23	IV
- Determination of lysozyme in wine using high-performance capillary electrophoresis (OIV-OENO 385-2012)	OIV-MA-AS315-24	IV
- Determination of lysozyme in wine using high-performance liquid chromatography (OIV-OENO 458-2014)	OIV-MA-AS315-25	IV
- Method of determination of biogenic amines in wine by high-performance liquid chromatography with photodiode array detection (OIV-OENO 457-2014)	OIV-MA-AS315-26	IV
- Analysis of volatile compounds in wines by gas	OIV-MA-AS315-27	IV

COMPENDIUM OF INTERNATIONAL METHODS OF ANALYSIS-OIV
Table of contents

chromatography (OIV-OENO 553-2016, OIV-OENO 606-2018)		
- Method of determination of 1,2-propanediol and 2,3-butanediol (OIV-OENO 598-2017)	OIV-MA-AS315-28	IV
- Detection of chitinase and thaumatin-like proteins in white wines (OIV-OENO 529-2017)	OIV-MA-AS315-29	IV
- Determination of alkylphenols in wines by gas chromatography-mass spectrometry (GC-MS or GC-MS/MS) (OIV-OENO 620-2020)	OIV-MA-AS315-30	IV
- Qualitative determination of sweeteners in wine by liquid chromatography coupled with mass spectrometry (LC-MS) (OIV-OENO 636-2021)	OIV-MA-AS315-31	IV
- Determination of sweeteners in white wine and white wine-based beverages by high performance liquid chromatography coupled with a diode detector and a charged aerosol detector (OIV-OENO 665-2022)	OIV-MA-AS315-32	
<i>SECTION 3.1.5 – MULTIELEMENT ORGANIC COMPOUNDS</i>		
- Quantitation of glucose, malic acid, acetic acid, fumaric acid, shikimic acid and sorbic acid in wine using quantitative nuclear magnetic resonance spectrometry (¹ H NMR) (OIV-OENO 618-2020)	OIV-MA-AS316-01	IV
<i>SECTION 3.2 – NON ORGANIC COMPOUNDS</i>		
<i>SECTION 3.2.1 – ANIONS</i>		
- Total Bromide (A 23 revised by OIV/OENO 377/2009)	OIV-MA-AS321-01	IV
- Chlorides (A 15 revised by OIV/OENO 377/2009)	OIV-MA-SA321-02	II
- Fluorides (A 22; OENO 22/2004; OIV/OENO 377/2009)	OIV-MA-AS321-03	II
- Total Phosphorus (A 16 revised by OIV/OENO 377/2009)	OIV-MA-AS321-04	IV
- Sulfates (gravimetry) (A 14 revised by OIV/OENO 377/2009)	OIV-MA-AS321-05A	II
- Sulfates (titrimetry) (A 14)	OIV-MA-AS321-05B	Withdrawn
<i>SECTION 3.2.2 – CATIONS</i>		
- Ammonium (A 20 revised by OIV/OENO 377/2009)	OIV-MA-AS322-01	IV
- Potassium (AAS) (A 8 revised by OIV/OENO 377/2009)	OIV-MA-AS322-02A	II
- Potassium (flame photometry) (A 8 revised by OIV/OENO 377/2009)	OIV-MA-AS322-02B	III
- Potassium (gravimetry) (A 8 revised by OIV/OENO 377/2009)	OIV-MA-AS322-02C	Withdrawn
- Sodium (AAS) (A 25 revised by OIV/OENO 377/2009)	OIV-MA-AS322-03A	II
- Sodium (flame photometry) (A 25 revised by OIV/OENO 377/2009)	OIV-MA-AS322-03B	III
- Calcium (A 26 revised by OIV/OENO 377/2009)	OIV-MA-AS322-04	II
- Iron (AAS) (A 9 revised by OIV/OENO 377/2009)	OIV-MA-AS322-05A	IV
- Iron (colorimetry) (A 9 revised by OIV/OENO 377/2009)	OIV-MA-AS322-05B	IV
- Copper (Recueil OIV ed. 1990 revised by OIV/OENO 377/2009)	OIV-MA-AS322-06	IV

COMPENDIUM OF INTERNATIONAL METHODS OF ANALYSIS-OIV
Table of contents

- Magnesium (A 26)	OIV-MA-AS322-07	II
- Zinc (A 45)	OIV-MA-AS322-08	IV
- Silver (Recueil OIV ed. 1990 revised by OIV/OENO 377/2009)	OIV-MA-AS322-09	IV
- Cadmium (Recueil OIV ed. 1990 revised by OIV/OENO 377/2009)	OIV-MA-AS322-10	IV
- Lead (OENO 3/94)	OIV-MA-AS322-11	Withdrawn
- Lead (criteria for methods) (OENO 7/2006; OIV/OENO 377/2009)	OIV-MA-AS322-12	II
Analysis of mineral elements in wines using ICP-AES (inductively coupled plasma / atomic emission spectrometry) (OIV-OENO 478-2013) <i>SECTION 3.2.3 – OTHER NON ORGANIC COMPOUNDS</i>	OIV-MA-AS322-13	III
- Arsenic (AAS) (Oeno 14/2002 revised by OIV/OENO 377/2009)	OIV-MA-AS323-01A	IV
- Arsenic (AAS) (A 34 revised by OIV/OENO 377/2009)	OIV-MA-AS323-01B	IV
- Arsenic (colorimetry) (A 34; OIV/OENO 377/2009)	OIV-MA-AS323-01C	Withdrawn
- Total nitrogen - Dumas method (OENO 13/2002 revised by OIV/OENO 377/2009)	OIV-MA-AS323-02A	II
- Total nitrogen - (A 40 revised by OIV/OENO 377/2009, OIV-OENO 683-2022)	OIV-MA-AS323-02B	IV
- Boron (A 44 revised by OIV/OENO 377/2009)	OIV-MA-AS323-03	IV
- Free Sulfur dioxide (titrimetry) (A 17 revised by OIV/OENO 377/2009, OIV-OENO 591A-2018 and OIV-OENO 661-2021)	OIV-MA-AS323-04A1	IV
- Total Sulfur dioxide (titrimetry) (A 17 revised by OIV/OENO 377/2009, OIV-OENO 591A-2018 and OIV-OENO 661-2021)	OIV-MA-AS323-04A2	II
- Sulfur dioxide (Iodometry) (A17 revised by OIV/OENO 377/2009)	OIV-MA-AS323-04B	IV
- Sulfur dioxide (molecular method) (A17 revised by OIV/OENO 377/2009)	OIV-MA-AS323-04C	IV
- Mercury - atomic Fluorescence (Oeno 15/2002 revised by OIV/OENO 377/2009)	OIV-MA-AS323-06	IV
- Multielemental analysis using ICP-MS (OIV/OENO 344/2010, OIV-OENO 666-2023)	OIV-MA-AS323-07	II
- Assay of pesticide residues in wine following extraction using the Quechers method (OIV-OENO 436-2012)	OIV-MA-AS323-08	II
- Determination of natamycin in wines (OIV-OENO 461-2012)	OIV-MA-AS323-09	IV
- Method of determination of phthalates by gas chromatography / mass spectrometry in wines (OIV-OENO 477-2013 revised by OIV-OENO 596-2019)	OIV-MA-AS323-10	II/IV
- Method for the determination of potassium polyaspartate in wine by high-performance liquid chromatography coupled with a fluorescence detector (OIV-OENO 619-2019)	OIV-MA-AS323-11	IV
- Simultaneous analysis of iron, copper, potassium, calcium	OIV-MA-AS323-12	IV

COMPENDIUM OF INTERNATIONAL METHODS OF ANALYSIS-OIV
Table of contents

and manganese in wines, using MP/AES (microwave-induced plasma atomic emission spectrometry) (OIV-OENO 637-2021)

SECTION 4 – MICROBIOLOGICAL ANALYSIS

- Microbiological Analysis (OIV-OENO 206-2010)	OIV-MA-AS4-01	IV
- Detection of preservatives and fermentation inhibitors (Fermentability Test) (A35; OENO 6/2006 revised by OIV/OENO 377/2009)	OIV-MA-AS4-02A	IV
- Detection of preservatives and fermentation inhibitors (Detection of the following acids: sorbic, benzoic, <i>p</i> -chlorobenzoic, salicylic, <i>p</i> -hydroxybenzoic and its esters) (A35; OENO 6/2006 revised by OIV/OENO 377/2009)	OIV-MA-AS4-02B	IV
- Detection of preservatives and fermentation inhibitors (Detection of the monohalogen derivatives of acetic acid) (A35; OENO 6/2006 revised by OIV/OENO 377/2009)	OIV-MA-AS4-02C	IV
- Detection of preservatives and fermentation inhibitors (determination of ethyl pyrocarbonate) (A35; OENO 6/2006 revised by 377/2009)	OIV-MA-AS4-02D	IV
- Detection of preservatives and fermentation inhibitors (Examination of dehydroacetic acid) (A35; OENO 6/2006 revised by OIV/OENO 377/2009)	OIV-MA-AS4-02E	IV
- Detection of preservatives and fermentation inhibitors (Sodium Azide by HPLC) (A35; OENO 6/2006 revised by OIV/OENO 377/2009)	OIV-MA-AS4-02F	IV
- Enumerating yeasts of the species <i>Brettanomyces bruxellensis</i> using qPCR (OIV-OENO 414-2011)	OIV-MA-AS4-03	IV

SECTION 5 – OTHER ANALYSIS

- Differentiation of fortified musts and sweet fortified wines (revised by OIV/OENO 377/2009)	OIV-MA-AS5-01	
---	---------------	--

ANNEX B - CERTIFICATES OF ANALYSIS

- Rules for the implementation of the analytical methods	OIV-MA-B1-01	
- Certificates of analysis	OIV-MA-B1-02	

ANNEX C - MAXIMUM ACCEPTABLE LIMITS OF VARIOUS SUBSTANCES

- Maximum acceptable limits of various substances contained in wine	OIV-MA-C1-01	
---	--------------	--

ANNEX D – ADVICES

- Gluconic Acid (OENO 4/91)	OIV-MA-D1-01	
- Characterization of wines resulting from overpressing (OENO 5/91)	OIV-MA-D1-02	
- Level of sodium and chlorides ions in wines (OENO 6/91)	OIV-MA-D1-03	
- Total dry extract (total dry extract, total dry extract without sugars, residual extracts) (OIV-CST 668-2022)	OIV-MA-D1-04	

COMPENDIUM OF INTERNATIONAL METHODS OF ANALYSIS-OIV
Table of contents

ANNEX E – LABORATORY QUALITY ASSURANCE

- Validation Principle (OENO 7/98)	OIV-MA-AS1-05	
- Collaborative Study	OIV-MA-AS1-07	
- Reliability of methods (OENO 5/99)	OIV-MA-AS1-08	
- Protocol for the design, conducts and interpretation of collaborative studies (OENO 6/2000)	OIV-MA-AS1-09	
- Estimation of the detection and quantification limits of a method of analysis (OENO 7/2000)	OIV-MA-AS1-10	
- Harmonized guidelines for internal quality control in analytical chemistry laboratories (OENO 19/2002)	OIV-MA-AS1-11	
- Practical guide for the Validation (OENO 10/05)	OIV-MA-AS1-12	
- Harmonised guidelines for single-laboratory validation (OENO 8/05)	OIV-MA-AS1-13	
- Recommendations on measurement uncertainty (OENO 9/05)	OIV-MA-AS1-14	
- Recommendations related to the recovery correction (OIV/OENO 392/2009)	OIV-MA-AS1-15	

ANNEX F – SPECIFIC METHODS FOR THE ANALYSIS OF GRAPE SUGAR (RECTIFIED CONCENTRATED MUSTS)

- Conductivity (OIV-OENO 419A-2011)	OIV-MA-F1-01	IV
- Hydroxymethylfurfural (HMF) by High-Performance Liquid Chromatography (OIV-OENO 419A-2011)	OIV-MA-F1-02	IV
- Determination of the acquired alcoholic strength by volume (ASV) of concentrated musts (CM) and grape sugar (or rectified concentrated musts, RCM) (OIV-OENO 419A-2011)	OIV-MA-F1-03	IV
- Sucrose by high-performance liquid chromatography (OIV-OENO 419A-2011)	OIV-MA-F1-04	IV
- Total acidity (OIV-OENO 419A-2011)	OIV-MA-F1-05	IV
- pH (OIV-OENO 419A-2011)	OIV-MA-F1-06	IV
- Sulphur dioxide (OIV-OENO 419A-2011)	OIV-MA-F1-07	IV
- Chromatic properties (OIV-OENO 419A-2011)	OIV-MA-F1-08	IV
- Total cations (OIV-OENO 419B-2012)	OIV-MA-F1-09	I
- Heavy metals by ETAAS (OIV-OENO 419B-2012)	OIV-MA-F1-10	IV
- Heavy metals by ICP-MS (OIV-OENO 419B-2012)	OIV-MA-F1-11	IV
- Determination of meso-inositol, scyllo-inositol and sucrose (OIV-OENO 419C-2012)	OIV-MA-F1-12	II
- Folin-Ciocalteu Index (OIV-OENO 419D-2012)	OIV-MA-F1-13	IV

ANNEXE G: GRAPE JUICE, RECONSTITUTED GRAPE JUICE, CONCENTRATED GRAPE JUICE AND GRAPE NECTAR

- Measuring Ochratoxin A in grape juice, reconstituted grape juice, concentrated grape juice, and grape nectar, after going through an immunoaffinity column and high liquid performance chromatography with fluorescence	OIV-MA-G1-01	IV
---	--------------	----

COMPENDIUM OF INTERNATIONAL METHODS OF ANALYSIS-OIV
Table of contents

detection (OIV-OENO 662A-2022)		
- Determination of volatile acidity in grape juice, reconstituted grape juice, concentrated grape juice, and grape nectar (OIV-OENO 662C-2022)	OIV-MA-G1-02	IV
- Method for 18O/16O isotope ratio determination of water in grape juice (OIV-OENO 662H-2022)	OIV-MA-G1-03	IV
- Horizontal method for the enumeration of coliforms – Colony- Count technique (OIV-OENO 662M-2023)	OIV-MA-G1-04	IV
- Horizontal method for the enumeration of beta-glucuronidase- positive Escherichia coli (OIV-OENO 662N-2023)	OIV-MA-G1-05	IV
- Horizontal method for the enumeration of coagulase-positive staphylococci (OIV-OENO 662O-2023)	OIV-MA-G1-06	IV
- Horizontal method for the enumeration of microorganisms (OIV-OENO 662P-2023)	OIV-MA-G1-07	IV
- Soluble solids in grape juice, reconstituted grape juice, concentrated grape juice, and grape nectar (OIV-OENO 662F-2023)	OIV-MA-G1-08	IV

Foreword

The *Compendium of International Methods of Wine Analysis* was first published in 1962 and re-published in 1965, 1972, 1978, 1990 and 2000; each time it included additional material as approved by the General Assembly and produced each year by the Sub-Commission.

This edition of *Compendium of International Methods of Wine and Must Analysis* includes all material as approved by the General Assembly of representatives of the member governments of the OIV, revised and amended since 2000.

The Compendium plays a major part in harmonising methods of analysis. Many vine-growing countries have introduced its definitions and methods into their own regulations.

Regulation (EC) No 479/2008 lays down that *the analysis methods for establishing the composition of the products covered by that Regulation and the rules for checking whether those products have been subjected to processes in violation of authorised oenological practice are those recommended and published by the OIV in the Compendium of International Methods of Analysis of Wines and Musts*. In Regulation (EC) No 606/2009 to ensure greater transparency, it was stated to publish at Community level (C Series of the *Official Journal of the European Union*) the list and description of the analysis methods described in the Compendium of International Methods of Analysis of Wines and Musts of the International Organisation of Vine and Wine and applicable for the control of vitivinicultural products.

In this way the European Union recognises all of the methods in the Compendium and makes them binding in all Member States, confirming the close collaboration established between the EU and the OIV.

Thus, through its leading role in the harmonisation of methods of analysis, the Compendium contributes to facilitating international trade. With the *International Code of Oenological Practices* and

the *International Oenological Codex*, it constitutes a body of considerable scientific, legal and practical benefit.

**Layout and wording of OIV
method of analysis**

Extract of ISO 78-2:1999 standard

1. Title

2. Introduction

optional

3. Scope

This clause shall state succinctly the method of chemical analysis and specifically the product to which applies.

4. Définitions

5. Principle

This optional clause indicates the essential steps in the method used, the basic principles.

6. Reagents and materials

This clause shall list all the reagents and materials used during the test, together with their essential characteristics, and shall specify, if necessary, their degree of purity.

Shall be given :

Products used in their commercially available form

Solutions of defined concentration

Standard volumetric solution

Standard reference solution

Standard solution

Standard matching solution

Note : each reagent shall be mentioned by a specific reference number

7. Apparatus

This clause shall list the names and significant characteristics of all the apparatus and equipment to be used during the analysis or test.

8. Sampling (Preparation of the sample)

Shall be given :
Sampling procedure
Preparation of the test sample

9. Procedure

Each sequence of operations shall be described unambiguously and concisely.
This clause shall normally include the following subclauses :

Test portion (this subclause shall give all the information necessary for the preparation of the test portion from the test sample).

Determination(s), or test(s) (this subclause shall be described accurately in order to facilitate the description, the understanding and the application of the procedure).

Calibration (if necessary).

10. Calculation (Results)

This clause shall indicate the method for calculating the results. Shall be precised the units, the equation used, the meanings of the algebraic symbols, the number of decimal places to which the results is to be given.

11. Precision (if interlaboratory validation)

The precision data shall be indicated:

The number of laboratories

The mean value of the concentration

The repeatability and the reproducibility

The repeatability and reproducibility standard deviation

A reference to the document containing the published results of the interlaboratory tests.

12. Annex

Annex related to precision clauses

Annex concerning statistical and other data derived from the results of interlaboratory tests.

13. Bibliography

Annex related to precision clauses

This annex shall indicate in particular

- repeatability statements
- reproducibility statements

Annex concerning statistical and other data derived from
the results of interlaboratory tests.

Statistical and other data derived from the results of interlaboratory tests may be given in an informative annex.

Example of table giving statistical results

Sample identification	A	B	C
Number of participating laboratories			
Number of accepted test results			
Mean values (g/100g sample)			
True or accepted value (g/100g)			
Repeatability standard deviation (S_r)			
Repeatability coefficient of variation			
Repeatability limit (r) ($2,8 \times S_r$)			
Reproducibility standard deviation (S_R)			
Reproducibility coefficient of variation			
Reproducibility limit (R) ($2,8 \times S_R$)			

Whilst it may not be considered necessary to include all the data shown in the table, it is recommended that at least the following data be included:

- The number of laboratories
- The mean value of the concentration
- The repeatability standard deviation
- The reproducibility standard deviation
- A reference to the document containing the published results of the interlaboratory tests.

Annex A

**Methods of analysis of
wines and musts**

General Remarks

- 1/ Clear wine or must, must be used for chemical and physical analysis. If the wine or the must is cloudy, it is first filtered through filter paper in a covered funnel or centrifuged in a closed container. This operation must be stated on any required documentation.
- 2/ The reference of the method employed for each determination must be on any required documentation.
- 3/ Units of measure for the various magnitudes (volume, mass, concentration, temperature, pressure, etc.) shall be in accordance with the recommendations of the IUPAC (International Union for Pure and Applied Chemistry).
- 4/ In respect of reagents and titration solutions used, unless otherwise required in the text, the chemicals used are to be of "analytical grade" and the water is to be distilled or of equivalent purity.
- 5/ Enzyme methods, and the determination of a number of parameters, are to be based on absolute measurements of absorbance, which requires spectrophotometers to be calibrated for wavelengths and absorbance. Wavelength may be calibrated by use of Hg lines: 239.94, 248.0, 253.65, 280.4, 302.25, 313.16, 334.15, 365.43, 404.66, 435.83, 546.07, 578.0, and 1014.0 nm. Absorbance may be calibrated by means of commercial reference solutions, obtained from suitable suppliers, or neutral density filters.
- 6/ The essential bibliographical references are given. The references to working documents of the Sub-Commission are marked '*F.V.*, *O.I.V.*' (feuilletts verts or 'green pages'), followed by the year of publication and the number of the document.

Classification of analytical methods

(Resolution ~~Oeno~~[OENO](#) 9/2000)

CATEGORY I* (CRITERION BENCHMARK METHOD): A method which determines a value that can be arrived at only by implementing the method *per se* and which serves, by definition, as the only method for establishing the accepted value of the parameter measured (e.g., alcoholometric content, total acidity, volatile acidity).

CATEGORY II* (BENCHMARK METHOD): A category II method is designated as the Benchmark Method in cases where category I methods cannot be used. It should be selected from category III methods (as defined below). Such methods should be recommended for use in cases of disputes and for calibration purposes. (e.g., potassium, citric acid).

CATEGORY III* (APPROVED ALTERNATIVE METHODS): A category III Method meets all of the criteria specified by the Sub-Committee on Methods of Analysis and is used for monitoring, inspection and regulatory purposes (e.g., enzymatic determinations of glucose and fructose).

CATEGORY IV (AUXILIARY METHOD): A category IV Method is a conventional or recently-implemented technique, with respect to which the Sub-Committee on Methods of Analysis has not as yet specified the requisite criteria (e.g., synthesized coloring agents, measurement of oxidation-reduction potential).

* Methods requiring formal approval in accordance with the procedures in force at the Sub-Commission of Methods of Analysis.

**Matrix effect for metals content analysis
using atomic absorption**

(Resolution OENO 5/2000)

The GENERAL ASSEMBLY,

In consideration of Article 5, Paragraph 4 of the International Standardization Convention on Methods of Wine Analysis and Rating of October 13, 1954,

Action on the proposal of the Sub-Committee on International Methods of Analysis and Rating of Wines,

CONSIDERING that the methods described in the Compendium of International Methods of Wine and Must Analysis and entailing the use of reference solutions are implemented for dry wines,

DRAWS the attention of users to the fact that deviations may be observed in other cases involving the presence of sugars or sugar derivatives,

DECIDES that it is therefore necessary to undertake analyses using the quantified additions method. A minimum of three aliquot portions of the sample containing various additions should be used.

DECIDES to supplement the methods for analyzing metals (iron, lead, zinc, silver, cadmium) and arsenic with a description of the quantified additions technique, when the matrix effect so requires.

**COMPENDIUM OF INTERNATIONAL ANALYSIS OF METHODS -
OIV**

**Provisions on the use of proprietary methods that should be
adopted by the OIV**

**Provisions on the use of proprietary methods that should be
adopted by the OIV**

(Resolution OIV-OENO 526-2016)

Definition of a Proprietary Method of Analysis

For OIV purposes, a proprietary method of analysis is one that contains protected intellectual property preventing full disclosure of information about the method and/or where the intellectual property owner restricts the use or distribution of the method or materials for its performance such that no alternative source of these would be available. It does not extend to a method which is subject only to copyright.

Requirements

The OIV requires the method sponsors to provide relevant data to enable the SCMA (“Methods of Analysis” Sub-Commission) or another expert group to carry out an assessment. Following assessment, the SCMA, or another expert group, may submit methods of analysis that are proprietary, or are based on proprietary aspects, to the OIV General Assembly, for their approval, according to the following procedures.

- a) A proprietary method should not be endorsed if a suitable non-proprietary method of analysis is available that has been or could be endorsed and that has similar or better performance characteristics. This should ensure that no approach is taken that could suggest that a proprietary method is endorsed by the OIV to the detriment of other potential methods; where possible preference should be given to adopting appropriate method criteria rather than endorsing a specific proprietary method of analysis.
- b) Whilst respecting the necessity for reasonable protection of intellectual property, sufficient information should be available to enable reliable use of the method by analysts and to enable evaluation of the performance of the method by the SCMA or another expert group. In particular cases this may extend beyond performance data, for example, including details of the operating principle, at the sole discretion of the SCMA or another expert group.
- c) Preference should be given to endorsing those methods of analysis where the reagents and/or apparatus are described in the method, to the extent that either

**COMPENDIUM OF INTERNATIONAL ANALYSIS OF METHODS -
OIV**

**Provisions on the use of proprietary methods that should be
adopted by the OIV**

laboratories or other manufacturers could produce these themselves; alternatively, details enabling them to acquire these themselves would also suffice.

- d) Method performance criteria required for proprietary methods are the same as those for non-proprietary methods. The performance criteria should be those stipulated above. If appropriate, information about the effect of variability of the reagents used should be provided.
- e) After endorsing, any changes that may influence performance characteristics must be reported to the SCMA or another expert group for consideration.
- f) A method with some parts that constitute protected proprietary information should be fully and collaboratively validated according to the OIV standards appearing in Annex A of the Compendium of International Methods of Analysis of Wines and Musts. The results of such studies will be made available for the SCMA or another expert group.
- g) The manufacturer or the party submitting for evaluation a proprietary method should demonstrate to the satisfaction of the SCMA or another expert group that the fundamental principles and characteristics for the execution of the method may be made available to all interested parties.
- h) The SCMA or another expert group may decline to assess a proprietary method if intellectual property restrictions unduly limit research into determining the method properties, scope and validity or development of improvements to the technology.
- i) If suitable non-proprietary methods become available and endorsed, the status of the previously endorsed proprietary method should be reviewed and revised if necessary.

Method OIV-MA-AS2-01

Type I and IV Methods

Density and Specific Gravity at 20^oC

(A1 revised by OIV-OENO 601A-2021)

1. Scope of application

This resolution is applicable for determining the density and specific gravity at 20 °C of wines and musts, using any of the following:

- | | |
|---|-----------------|
| A. Pycnometry | Type I Method, |
| B. Electronic densimetry using a frequency oscillator | Type I Method, |
| C. Densimetry using a hydrostatic balance | Type I Method, |
| D. Hydrometry | Type IV Method. |

2. Definition

Density is the quotient of the mass of a certain volume of wine or must at 20 °C by this volume. It is expressed in g/cm³ and its symbol is $\rho_{20\text{ °C}}$.

The specific gravity is the ratio of the density of a substance to the density of a reference material. For the analysis of wine or must, it is typically expressed as the ratio of the density of the wine or must at 20 °C to the density of water at 20 °C. Its symbol is: $d_{20\text{ °C}}^{20\text{ °C}}$

Note: It is possible to obtain the specific gravity from the density ρ_{20} at 20 °C:

$\rho_{20} = 0.998203 \times d_{20\text{ °C}}^{20\text{ °C}}$ or $d_{20\text{ °C}}^{20\text{ °C}} = \rho_{20} / 0.998203$ (where 0.998203 is the density of water at 20 °C in g/ cm³)

3. Principle of the methods

The principle of each method is detailed in the following parts:

Method A: Pycnometry

Method B: Electronic densimetry using a frequency oscillator

Method C: Densimetry using a hydrostatic balance

Method D: Hydrometry

Note: For very precise determinations, the density should be corrected to account for sulphur-dioxide action.

$$\rho_{20} \text{ (g/cm}^3\text{)} = \rho'_{20} - 0.0006 \times S$$

$$\rho_{20} \text{ (g/cm}^3\text{)} = \text{corrected density}$$

$$\rho'_{20} \text{ (g/cm}^3\text{)} = \text{observed density}$$

$$S \text{ (g/L)} = \text{total sulphur dioxide}$$

4. Preliminary sample preparation

If the wine or must contains notable quantities of carbon dioxide, remove the grand majority by, for example, mixing 250 mL of sample in a 1000-mL vial, or by filtering under reduced pressure on 2 g of cotton placed in an extension tube, or by any other suitable method.

Method A: Density at 20 °C and specific gravity at 20 °C measured by pycnometry (Type method)

A.1 Principle

The density of the wine or must is measured for a specific temperature using a glass pycnometer. This comprises a flask of known capacity, onto which a hollow ground-glass stopper is fitted equipped with a capillary tube. When the flask is closed, the overflow rises in the capillary. The volumes of the flask and the capillary being known, the density is determined by weighing using precision balances before and after filling of the pycnometer.

A.2 Reagents and products

A.2.1 Type II water for analytical use (ISO 3696 standard), or of equivalent purity

A.2.2 Sodium chloride solution (2% m/v)

To prepare 1 litre, weigh out 20 g of sodium chloride and dissolve to volume in water.

A.3 Apparatus and materials

Current laboratory apparatus, including the following:

A.3.1 Pyrex-glass pycnometer of around 100 mL capacity with a removable thermometer, with ground-glass joint and 10th-of-a-degree graduations, from 10 °C to 30 °C. This thermometer should be calibrated (Fig. 1).

Any pycnometer of equivalent characteristics may be used.

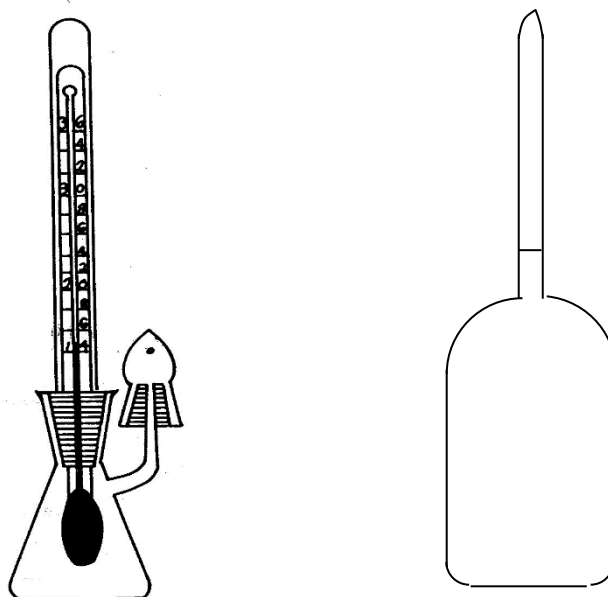

FIGURE 1: Pycnometer and its tare bottle

This pycnometer includes a side tube of 25 mm in length and an inside diameter of at most 1 mm, terminated by a ground-glass conical joint. This side tube may be capped by a 'reservoir stopper' composed of a ground-glass conical tube, terminated by a tapered joint. This stopper serves as an expansion chamber.

The two joints of the apparatus should be prepared with great care.

A.3.2 Tare bottle of the same external volume (to within 1 mL) as the pycnometer and with a mass equal to the mass of the pycnometer filled with a liquid of a density of 1.01 g/mL (sodium chloride solution at 2% m/v).

A.3.3 Thermally insulated jacket that fits the body of the pycnometer exactly.

A.3.4 Twin-pan balance accurate to the nearest 0.1 mg
or
single-plate balance accurate to the nearest 0.1 mg.

A.3.5 Masses calibrated by an accredited body

A.4 Procedure

A.4.1 Pycnometer calibration

The calibration of the pycnometer comprises the determination of the following characteristics:

- tare weight,
- volume at 20 °C,
- water mass at 20 °C.

A.4.1.1 Using a twin-pan balance

Place the tare bottle on the left-hand pan and the clean, dry pycnometer with its 'reservoir stopper' on the right-hand pan. Balance them by placing weights of known mass on the pycnometer side: p grams.

Fill the pycnometer carefully with water (A.2.1) at room temperature and fit the thermometer.

Carefully wipe the pycnometer dry and place it in the thermally insulated jacket. Shake by inverting the container until the thermometer's temperature reading is constant, accurately adjust the level to the upper rim of the side tube, wipe the side tube clean and fit the reservoir stopper.

Read the temperature, t °C, carefully and if necessary correct for any inaccuracies in the temperature scale.

Weigh the water-filled pycnometer, with the weight in grams, p' , making up the equilibrium.

Calculations:

- Tare of the empty pycnometer:

Tare weight = $p + m$ where m (g) = mass of the air contained in the pycnometer

$$m \text{ (g)} = 0.0012 (p - p')$$

- Volume at 20 °C in mL:

$$V_{20^\circ\text{C}} \text{ (mL)} = (p + m - p') \times F_t$$

F_t = factor for temperature, t °C, taken from Table I

$V_{20^\circ\text{C}}$ should be known to ± 0.001 mL

- Water mass at 20 °C:

$$M_{20^{\circ}\text{C}} (\text{g}) = V_{20^{\circ}\text{C}} \times 0.998203$$

0.998203 (g/cm³) = water density at 20 °C

A.4.1.2 *Using a single-pan balance*

Determine:

- the mass of the clean, dry pycnometer: P,
- the mass of the water-filled pycnometer at $t^{\circ}\text{C}$: P₁ following the instructions outlined in A.4.1.1,
- the mass of the tare bottle, T₀.

- Calculations:

Tare of the empty pycnometer:

Tare weight: P – m where m (g) = mass of the air contained in the pycnometer

$$m (\text{g}) = 0.0012 (P_1 - P)$$

- Volume at 20 °C in mL:

$$V_{20^{\circ}\text{C}} (\text{mL}) = [P_1 - (P - m)] \times F_t$$

F_t = factor for temperature, $t^{\circ}\text{C}$, taken from Table I

$V_{20^{\circ}\text{C}}$ should be known to ± 0.001 mL

- Water mass at 20 °C:

$$M_{20^{\circ}\text{C}} (\text{g}) = V_{20^{\circ}\text{C}} \times 0.998203$$

0.998203 = water density at 20 °C (g/cm³)

A.4.2 Determination of the density:

A.4.2.1 *Using a twin-pan balance*

Weigh the pycnometer filled with the test sample following the instructions outlined in A.4.1.1.

Where p'' represents the mass in grams that makes up the equilibrium at $t^{\circ}\text{C}$, taking into account that the liquid mass contained in the pycnometer = $p + m - p''$, the apparent density at $t^{\circ}\text{C}$, in g/cm³, is given by the following equation:

$$\rho_{t^{\circ}\text{C}} = \frac{p + m - p''}{V_{20^{\circ}\text{C}}}$$

Calculate the density at 20 °C using one of the following correction tables in Annex I, according to the nature of the liquid to be analysed and the type of pycnometer to be used: dry wine and dealcoholized wine (Table II or V),

natural or concentrated must (Table III or VI), or liqueur wine (Table IV or VII).

A.4.2.2. Using a single-pan balance

Weigh the tare bottle, where T_1 is its mass in g.

Calculate $dT = T_1 - T_0$

Mass of the empty pycnometer at the time of measurement = $P - m + dT$ in g

Weigh the pycnometer filled with the test sample following the instructions outlined in A.4.1.1.

Where P_2 represents its mass at t °C,

the liquid mass contained in the pycnometer at t °C = $P_2 (P - m + dT)$ in g

and the apparent density at t °C, in g/cm³, is as follows

$$\rho_{t^{\circ}\text{C}} = \frac{P_2 - (P - m + dT)}{V_{20^{\circ}\text{C}}}$$

Calculate the density at 20 °C of the liquid to be analysed: dry wine, natural or concentrated must, or liqueur wine, as indicated in A.4.2.1.

A.5 Expression of results

The density is expressed in g/cm³ to 5 decimal places.

A.6 Precision

A.6.1 Repeatability in terms of density:

- for dry and sweet wines, except liqueur wines: $r = 0.00010$ g/cm³,
- for liqueur wines: $r = 0.00018$ g/cm³.

A.6.2. Reproducibility in terms of density:

- for dry and sweet wines, except liqueur wines: $R = 0.00037$ g/cm³,
- for liqueur wines: $R = 0.00045$ g/cm³.

A.7 Numerical example

A.7.1 Measurement by pycnometer on a twin-pan balance

A/ Calibration of the pycnometer

1. Weighing of the clean, dry pycnometer:

$$\text{Tare} = \text{pycnometer} + p$$

$$p = 104.9454 \text{ g}$$

2. Weighing of the water-filled pycnometer at the temperature t °C:

$$\text{Tare} = \text{pycnometer} + \text{water} + p'$$

$$p' = 1.2396 \text{ g for } t = 20.5 \text{ °C}$$

3. Calculation of the mass of the air contained in the pycnometer:

$$m = 0.0012 (p - p')$$

$$m = 0.0012 (104.9454 - 1.2396)$$

$$m = 0.1244$$

4. Parameters to be kept:

$$\text{Tare of the empty pycnometer: } p + m$$

$$p + m = 104.9454 + 0.1244$$

$$p + m = 105.0698 \text{ g}$$

$$\text{Volume at } 20 \text{ °C} = (p + m - p') \times F_{t \text{ °C}}$$

$$F_{20.50 \text{ °C}} = 1.001900$$

$$V_{20 \text{ °C}} = (105.0698 - 1.2396) \times 1.001900$$

$$V_{20 \text{ °C}} = 104.0275 \text{ mL}$$

$$\text{Water mass at } 20 \text{ °C} = V_{20 \text{ °C}} \times 0.998203$$

$$M_{20 \text{ °C}} = 103.8405 \text{ g}$$

B/ Determination of the density at 20 °C and the 20 °C/20 °C specific gravity of a dry wine:

$$p' = 1.2622 \text{ g at } 17.80 \text{ °C}$$

$$\square_{17.80 \text{ °C}} = \frac{105.0698 - 1.2622}{104.0275}$$

$$\rho_{17.80 \text{ °C}} = 0.99788 \text{ g/cm}^3$$

Table II makes it possible to calculate $\rho_{20 \text{ °C}}$ from $\rho_{t \text{ °C}}$ using the following formula:

$$\rho_{20 \text{ °C}} = \rho_{t \text{ °C}} \pm \frac{c}{1000}$$

For $t = 17.80 \text{ °C}$ and for an alcoholic strength of 11% vol., $c = 0.54$:

$$\square_{20 \text{ °C}} = 0.99788 - \frac{0.54}{1000}$$

$$\rho_{20\text{ }^{\circ}\text{C}} = 0.99734 \text{ g/cm}^3$$

$$d_{20\text{ }^{\circ}\text{C}}^{20\text{ }^{\circ}\text{C}} = \frac{0.99734}{0.998203} = 0.99913$$

A.7.2 Measurement by pycnometer on a single-pan balance

A/ Establishment of the pycnometer constants

1. Weighing of the clean, dry pycnometer:
P = 67.7913 g
2. Weighing of the water-filled pycnometer at $t\text{ }^{\circ}\text{C}$:
P₁ = 169.2715 g at 21.65 °C
3. Calculation of the mass of the air contained in the pycnometer:
m = 0.0012 (P₁ - P)
m = 0.0012 x 101.4802
m = 0.1218 g
4. Characteristics to be retained:
Tare of the empty pycnometer: P - m
P - m = 67.7913 - 0.1218
P - m = 67.6695 g
Volume at 20 °C = [P₁ - (P - m)] x F_{t °C}
F_{21.65 °C} = 1.002140
V_{20 °C} = (169.2715 - 67.6695) x 1.002140
V_{20 °C} = 101.8194 mL
Water mass at 20 °C: V_{20 °C} x 0.998203
M_{20 °C} = 101.6364 g
Mass of the tare bottle: T₀
T₀ = 171.9160 g

B/ Determination of the density at 20 °C and 20 °C/20 °C specific gravity of a dry wine:

$$T_1 = 171.9178$$

$$dT = 171.9178 - 171.9160 = 0.0018 \text{ g}$$

$$P - m + dT = 67.6695 + 0.0018 = 67.6713 \text{ g}$$

$$P_2 = 169.2799 \text{ at } 18\text{ }^{\circ}\text{C}$$

$$\square_{18\text{ }^{\circ}\text{C}} = \frac{169.2799 - 67.6713}{101.8194}$$

$$\rho_{18^{\circ}\text{C}} = 0.99793 \text{ g/cm}^3$$

Table II makes it possible to calculate $\rho_{20^{\circ}\text{C}}$ from $\rho_{t^{\circ}\text{C}}$ using the following formula:

$$\rho_{20^{\circ}\text{C}} = \rho_{t^{\circ}\text{C}} \pm \frac{c}{100c}$$

For $t = 18^{\circ}\text{C}$ and for an alcoholic strength of 11% vol., $c = 0.49$:

$$\rho_{20^{\circ}\text{C}} = 0.99793 - \frac{0.49}{1000}$$

$$\rho_{20^{\circ}\text{C}} = 0.99744 \text{ g/cm}^3$$

$$d_{20^{\circ}\text{C}}^{20^{\circ}\text{C}} = \frac{0.99744}{0.998203} = 0.99923$$

Method B: Density at 20 °C and specific gravity at 20 °C measured by electronic densimetry using a frequency oscillator (Type I method)

B.1 Principle

The density of the wine or must is measured by electronic densimetry using a frequency oscillator. The principle consists of measuring the period of oscillation of a tube containing the sample undergoing electromagnetic stimulation. The density is related to the period of oscillation by the following formula:

$$\rho = T^2 \times \left(\frac{C}{4\pi^2 V} \right) - \left(\frac{M}{V} \right) \quad (1)$$

ρ = density of the sample
T = period of induced vibration
M = mass of empty tube
C = spring constant
V = volume of vibrating sample

This relationship is in the form $\rho = A T^2 - B$ (2), so there is a linear relationship between the density and the period squared. The constants A and B are specific to each oscillator and are estimated by measuring the period of fluids of known density.

B.2. Reagents and products

B.2.1 Reference fluids

Two reference fluids are used to adjust the densimeter. The densities of the reference fluids should encompass the densities of the wines or musts to be analysed. A spread of greater than 0.01000 g/cm³ between the densities of the reference fluids is recommended.

The reference fluids used to measure the density of the wines or musts by electronic densimetry are as follows:

- dry air (unpolluted),
- Type II water for analytical usage (ISO standard 3696), or of equivalent analytical purity,

- hydro-alcoholic solutions, wines or musts whose densities have been determined by a different Type I method, for which the uncertainty does not exceed 0.00005 g/cm^3 at the temperature of $20.00 \pm 0.05 \text{ }^\circ\text{C}$,
- solutions calibrated with traceability to the International System of Units, with viscosities of less than $2 \text{ mm}^2/\text{s}$, for which the uncertainty does not exceed 0.00005 g/cm^3 at the temperature of $20.00 \pm 0.05 \text{ }^\circ\text{C}$.

B.2.2 Cleaning and drying products

Use products that ensure the perfectly clean and dried state of the measuring cell, according to the residues and manufacturer's indications. For example:

- detergents, acids, etc.,
- organic solvents: 96% vol. ethanol, pure acetone, etc.

B.3 *Apparatus and equipment*

B.3.1. Electronic densimeter with frequency oscillator

The electronic densimeter consists of the following elements:

- a measuring cell consisting of a measuring tube and a temperature controller,
- a system for setting up an oscillation tube and measuring the period of oscillation,
- a digital display and possibly a calculator,
- sample injector syringe, autosampler or other equivalent system.

The densimeter is placed on a perfectly stable support isolated from all vibrations.

B.3.2 Temperature control of the measuring cell

Locate the measuring tube in a temperature-controlled system. Temperature stability should be better than $\pm 0.02 \text{ }^\circ\text{C}$.

It is necessary to control the temperature of the measuring cell when the densimeter makes this possible, because this strongly influences the determination results. The density of a hydro-alcoholic solution with an alcoholic strength by volume (ABV) of 10% vol. is 0.98471 g/cm^3 at $20 \text{ }^\circ\text{C}$ and 0.98447 g/cm^3 at $21 \text{ }^\circ\text{C}$, equating to a spread of 0.00024 g/cm^3 .

The test temperature is $20 \text{ }^\circ\text{C}$. Measure the cell temperature with a resolution thermometer accurate to less than $0.01 \text{ }^\circ\text{C}$ and with traceability to national standards. This should enable a temperature measurement with an uncertainty of better than $\pm 0.07 \text{ }^\circ\text{C}$.

B.3.3 Calibration of the apparatus

The apparatus should be calibrated before using it for the first time, then periodically or if the verification is not satisfactory. The objective is to use two reference fluids to calculate the constants A and B [see formula (2), B.1]. To carry out the calibration in practice, refer to the user manual of the apparatus. In principle, this calibration is carried out with dry air (taking into account the atmospheric pressure) and very pure water (B.2.1).

B.3.4 Calibration verification

In order to verify the calibration, the density of the reference fluids is measured.

- Every day of use, a density check of the air is carried out. A difference between the theoretical density and observed density of more than 0.00008 g/cm³ may indicate that the tube is clogged. In that case, it should be cleaned. After cleaning, verify the air density again. If the verification is not conclusive, adjust the apparatus.
- Check the density of the water; if the difference between the theoretical density and the density observed is greater than 0.00008 g/cm³, adjust the apparatus.
- If verification of the cell temperature is difficult, it is possible to directly check the density of a hydro-alcoholic solution of comparable density to those of the samples analysed.

B.3.5 Checks

When the difference between the theoretical density of the reference solution (known with an uncertainty of ± 0.00005 g/cm³) and the measured density is above 0.00008 g/cm³, the calibration of the apparatus should be checked.

B.4 *Procedure*

Before measuring, if necessary, clean and dry the cell with acetone or absolute alcohol and dry air. Rinse the cell with the sample.

Inject the sample into the cell (using a syringe, autosampler or other equivalent system) so that it is filled completely. While filling, check that all air bubbles have been removed. The sample should be homogenous and not contain any solid particles. Where necessary, filter to remove any suspended matter before analysis.

If there is a lighting system available that makes it possible to verify the absence of bubbles, turn it off quickly after checking because the heat generated by the lamp can influence the measuring temperature (for apparatus with a permanent lighting system, this statement is not applicable).

The operator should ensure that the temperature of the measuring cell is stable.

Once the reading has been stabilised, record the density, $\rho_{20^{\circ}\text{C}}$.

If the apparatus only provides the period, the density can be calculated from the A and B constants (refer to the instructions for the equipment or Annex I of the method OIV-MA-AS312-01A).

B.5. *Expression of results*

The density is expressed in g/cm^3 to 5 decimal places.

B.6. *Precision parameters*

The precision parameters are detailed in Table 4 of Annex II.

Repeatability: $r = 0.00011 \text{ g/cm}^3$
Reproducibility: $R = 0.00025 \text{ g/cm}^3$

Method C: Density at 20 °C and specific gravity at 20 °C measured using a hydrostatic balance (Type I Method)

C.1 Principle

The density of wine or musts can be measured by densimetry with a hydrostatic balance following the Archimedes principle, by which any body immersed in a fluid experiences an upwards force equal to the weight of the displaced fluid.

C.2 Reagents and products

C.2.1 Type II water for analytical usage (ISO 3696 standard), or of equivalent purity

C.2.2 Floater-washing solution (sodium hydroxide, 30 % m/v)

To prepare a 100-mL solution weigh 30 g of sodium hydroxide and fill using 96% vol. ethanol.

C.3 Apparatus and materials

Normal laboratory apparatus, particularly:

C.3.1 Single-pan hydrostatic balance accurate to the nearest 1 mg

C.3.2 Floater with at least 20 mL volume, specifically adapted for the balance, suspended by a thread with a diameter of less than or equal to 0.1 mm

C.3.3 Cylindrical test tube with level indicator. The floater should be able to fit entirely within the test tube volume below the level indicator; only the hanging thread should break the surface of the liquid. The cylindrical test tube should have an inside diameter at least 6 mm greater than that of the floater.

C.3.4 Thermometer (or temperature-measurement probe) with degree and 10th-of-a-degree graduations, from 10 °C to 40 °C, calibrated to ± 0.06 °C

C.3.5 Masses calibrated by an accredited body.

C.4 Procedure

After each measurement, the floater and the test tube should be cleaned with distilled water, wiped with soft laboratory paper that does not lose its fibres and rinsed with solution whose density is to be determined. These measurements should be carried out once the apparatus has reached a stable level in order to limit alcohol loss through evaporation.

C.4.1 Calibration of the apparatus

C.4.1.1 *Balance calibration*

While balances usually have internal calibration systems, hydrostatic balances should be calibrated with weights with traceability to the International System of Units.

C.4.1.2 Floater calibration

Fill the cylindrical test tube up to the level indicator with water (C.2.1) whose temperature is between 15 °C and 25 °C, but preferably at 20 °C.

Plunge the floater and the thermometer into the liquid, shake, note down the density on the apparatus and, if necessary, adjust the reading in order for it to be equal to that of the water at the measurement temperature.

C.4.1.3 Verification using a solution of known density

Fill the cylindrical test tube up to the level indicator with a solution of known density at a temperature of between 15 °C and 25 °C, preferably at 20 °C.

Immerse the floater and the thermometer in the liquid, stir, read the density of the liquid indicated by the apparatus and record the density and the temperature where the density is measured at t °C (ρ_t).

If necessary, correct ρ using a ρ_t density table of hydro-alcoholic mixtures (Table II in Annex I).

The density determined in this way should be identical to the previously determined density.

Note: This solution of known density can also replace water for floater calibration.

C.4.2 Determination of the density

Pour the test sample into the cylindrical test tube up to the level indicator.

Plunge the floater and the thermometer into the liquid, shake and note down the density on the apparatus. Note the temperature if the density is measured at t °C (ρ_t).

Correct ρ_t using a ρ_t density table of hydro-alcoholic mixtures (Table II in the Annex).

C.4.3 Cleaning of the floater and cylindrical test tube

Plunge the floater into the washing solution in the test tube.

Allow to soak for one hour while turning the floater regularly.

Rinse with tap water, then with distilled water.

Wipe with soft laboratory paper that does not lose its fibres.

Carry out these operations when the floater is used for the first time and then on a regular basis when necessary.

C.5 *Expression of results*

The density is expressed in g/cm³ to 5 decimal places.

C.6 *Precision parameters*

The precision parameters are detailed in Table 4 of Annex II.

$$r = 0.00025 \text{ g/cm}^3$$

$$R = 0.00067 \text{ g/cm}^3$$

Method D: Density measured by hydrometry (Type IV Method)

D.1 Principle

The density and specific gravity at 20 °C are determined for the test sample by hydrometry following the Archimedes principle. A weighted cylinder equipped with a graduated stem is more or less immersed into the liquid sample whose density is to be determined. The density of the liquid is read directly on the graduation of the stem at the level of the meniscus.

D.2 Apparatus

D.2.1 Hydrometer

Hydrometers should meet ISO requirements relating to their dimensions and graduations.

They should have a cylindrical body and a circular stem with a cross-section of at least 3 mm in diameter. For dry wines, they should be graduated in g/cm³ from 0.983 to 1.003, with graduation marks at every 0.001 and 0.0002 interval. All of the marks at 0.001 intervals should be separated from the next by at least 5 mm. For the measurement of the specific gravity of dealcoholized wines, liqueur wines and musts, a set of 5 hydrometers are to be used, graduated (in g/cm³) from 1.000-1.030; 1.030-1.060; 1.060-1.090; 1.090-1.120; 1.120-1.150. These hydrometers are to be graduated for density at 20 °C by marks and intervals of no greater than 0.001 and 0.0005, with all the marks at the 0.001 intervals being separated from the next by at least 3 mm.

These hydrometers should be graduated so that they can be read at ‘top of the meniscus’. The indication of the graduation in density at 20 °C or specific gravity at 20 °C, and of the reading at the top of the meniscus, is to be given either on the graduated scale, or on a strip of paper attached to the bulb.

This apparatus should be calibrated with traceability to the International System of Units.

D.2.2 Thermometer graduated to intervals of no greater than 0.5 °C, calibrated with traceability to the International System of Units.

D.2.3 Measuring cylinder with dimensions that allow for the immersion of the thermometer and the hydrometer without contact with the sides, held vertically.

D.3 Measurement method

Place 250 mL of the test sample (4) in the measuring cylinder (D.2.3) and insert the hydrometer and thermometer. Stir the sample and wait 1 minute to allow temperature equilibration, then read the thermometer. Remove the thermometer and, after 1 minute of rest, read the apparent density at t °C on the stem of the hydrometer.

Correct the apparent density as read at t °C for the effect of the temperature, using the tables in Annex I applying to dry wines (Table V), natural and concentrated musts (Table VI) and liqueur wines (Table VII).

D.4 *Expression of results*

The density is expressed in g/cm³ to 4 decimal places.

COMPENDIUM OF INTERNATIONAL METHODS OF ANALYSIS - OIV
Density and Specific Gravity – Type I and IV methods

5. Annexes

ANNEX I
Tables

TABLE I

F factors

by which the mass of the water in the *Pyrex pycnometer* at t °C has to be multiplied to calculate the volume of the pycnometer at 20 °C

t °C	F	t °C	F	t °C	F	t °C	F	t °C	F	t °C	F	t °C	F
10.	1.00039	13.	1.00069	16.	1.00109	19.	1.00160	22.	1.00221	25.	1.00291	28.	1.00370
.0	1.00040	.0	1.00070	.0	1.00111	.0	1.00162	.0	1.00223	.0	1.00294	.0	1.00373
.1	1.00041	.1	1.00071	.1	1.00112	.1	1.00164	.1	1.00226	.1	1.00296	.1	1.00375
.2	1.00042	.2	1.00072	.2	1.00114	.2	1.00166	.2	1.00228	.2	1.00299	.2	1.00379
.3	1.00043	.3	1.00073	.3	1.00115	.3	1.00168	.3	1.00230	.3	1.00301	.3	1.00381
.4	1.00043	.4	1.00075	.4	1.00117	.4	1.00170	.4	1.00232	.4	1.00304	.4	1.00384
.5	1.00044	.5	1.00076	.5	1.00119	.5	1.00172	.5	1.00234	.5	1.00306	.5	1.00387
.6	1.00045	.6	1.00077	.6	1.00120	.6	1.00174	.6	1.00237	.6	1.00309	.6	1.00389
.7	1.00046	.7	1.00078	.7	1.00122	.7	1.00176	.7	1.00239	.7	1.00311	.7	1.00392
.8	1.00047	.8	1.00080	.8	1.00123	.8	1.00178	.8	1.00241	.8	1.00314	.8	1.00395
.9	1.00048	.9	1.00081	.9	1.00125	.9	1.00180	.9	1.00243	.9	1.00316	.9	1.00398
11.	1.00049	14.	1.00082	17.	1.00127	20.	1.00181	23.	1.00246	26.	1.00319	29.	1.00401
.0	1.00050	.0	1.00084	.0	1.00128	.0	1.00183	.0	1.00248	.0	1.00322	.0	1.00404
.1	1.00051	.1	1.00085	.1	1.00130	.1	1.00195	.1	1.00250	.1	1.00324	.1	1.00407
.2	1.00052	.2	1.00086	.2	1.00132	.2	1.00188	.2	1.00253	.2	1.00327	.2	1.00409
.3	1.00053	.3	1.00088	.3	1.00134	.3	1.00190	.3	1.00255	.3	1.00329	.3	1.00412
.4	1.00054	.4	1.00089	.4	1.00135	.4	1.00192	.4	1.00257	.4	1.00332	.4	1.00415
.5	1.00055	.5	1.00090	.5	1.00137	.5	1.00194	.5	1.00260	.5	1.00335	.5	1.00418
.6	1.00056	.6	1.00092	.6	1.00139	.6	1.00196	.6	1.00262	.6	1.00337	.6	1.00421
.7	1.00057	.7	1.00093	.7	1.00140	.7	1.00198	.7	1.00264	.7	1.00340	.7	1.00424
.8	1.00058	.8	1.00095	.8	1.00142	.8	1.00200	.8	1.00267	.8	1.00343	.8	1.00427
.9		.9		.9		.9		.9		.9		.9	
12.		15.		18.		21.		24.		27.		30.	

COMPENDIUM OF INTERNATIONAL METHODS OF ANALYSIS - OIV
Density and Specific Gravity – Type I and IV methods

.1	1.00059 1	.1	1.00096 5	.1	1.00144 5	.1	1.00202 3	.1	1.00269 6	.1	1.00345 9		
.2	1.00060 1	.2	1.00097 9	.2	1.00146 2	.2	1.00204 4	.2	1.00272 0	.2	1.00348 5		
.3	1.00061 2	.3	1.00099 3	.3	1.00148 0	.3	1.00206 5	.3	1.00274 5	.3	1.00351 3		
.4	1.00062 3	.4	1.00100 8	.4	1.00149 8	.4	1.00208 6	.4	1.00276 9	.4	1.00354 0		
12.	1.00063	15.	1.00102	18.	1.00151	21.	1.00210	24.	1.00279	27.	1.00356		
.5	1.00064 5	.5	1.00103 7	.5	1.00153 4	.5	1.00212 9	.5	1.00281 7	.5	1.00359 4		
.6	1.00065 6	.6	1.00105 2	.6	1.00155 2	.6	1.00215 1	.6	1.00284 2	.6	1.00362 1		
.7	1.00066 8	.7	1.00106 7	.7	1.00157 0	.7	1.00217 2	.7	1.00286 6	.7	1.00364 9		
.8	1.00067	.8	1.00108	.8	1.00158	.8	1.00219	.8	1.00289	.8	1.00367		
.9		.9		.9		.9		.9		.9			

Certified in conformity with Paris hybrid meeting, 12th July 2021
The Director General of the OIV
Secretary of the General Assembly
Pau ROCA

COMPENDIUM OF INTERNATIONAL METHODS OF ANALYSIS - OIV
Density and Specific Gravity – Type I and IV methods

TABLE II
 Temperature corrections, *c*, required for the density of dry wines and dealcoholised wines,
 measured using a Pyrex-glass pycnometer at *t* °C, in order to correct to 20 °C.

$$\rho_{20} = \rho_t \pm \frac{c}{1000} \begin{array}{l} - \text{ if } t \text{ }^\circ\text{C is lower than } 20 \text{ }^\circ\text{C} \\ + \text{ if } t \text{ }^\circ\text{C is higher than } 20 \text{ }^\circ\text{C} \end{array}$$

		Alcoholic strength																							
		0	5	6	7	8	9	10	11	12	13	14	15	16	17	18	19	20	21	22	23	24	25	26	27
Temperature in °C	10	1.59	1.64	1.67	1.71	1.77	1.84	1.91	2.01	2.11	2.22	2.34	2.46	2.60	2.73	2.88	3.03	3.19	3.35	3.52	3.70	3.87	4.06	4.25	4.44
	11	1.48	1.53	1.56	1.60	1.64	1.70	1.77	1.86	1.95	2.05	2.16	2.27	2.38	2.51	2.63	2.77	2.91	3.06	3.21	3.36	3.53	3.69	3.86	4.03
	12	1.36	1.40	1.43	1.46	1.50	1.56	1.62	1.69	1.78	1.86	1.96	2.05	2.16	2.27	2.38	2.50	2.62	2.75	2.88	3.02	3.16	3.31	3.46	3.61
	13	1.22	1.26	1.28	1.32	1.35	1.40	1.45	1.52	1.59	1.67	1.75	1.83	1.92	2.01	2.11	2.22	2.32	2.44	2.55	2.67	2.79	2.92	3.05	3.18
	14	1.08	1.11	1.13	1.16	1.19	1.23	1.27	1.33	1.39	1.46	1.52	1.60	1.67	1.75	1.94	1.93	2.03	2.11	2.21	2.31	2.42	2.52	2.63	2.74.
	15	0.92	0.96	0.97	0.99	1.02	1.05	1.09	1.13	1.19	1.24	1.30	1.36	1.42	1.48	1.55	1.63	1.70	1.78	1.86	1.95	2.03	2.12	2.21	2.30
	16	0.76	0.79	0.80	0.81	0.94	0.86	0.89	0.93	0.97	1.01	1.06	1.10	1.16	1.21	1.26	1.32	1.38	1.44	1.51	1.57	1.64	1.71	1.78	1.85
	17	0.59	0.61	0.62	0.63	0.65	0.67	0.69	0.72	0.75	0.78	0.81	0.85	0.88	0.95	0.96	1.01	1.05	1.11	1.15	1.20	1.25	1.30	1.35	1.40
	18	0.40	0.42	0.42	0.43	0.44	0.46	0.47	0.49	0.51	0.53	0.55	0.57	0.60	0.63	0.65	0.68	0.71	0.74	0.77	0.81	0.84	0.87	0.91	0.94
	19	0.21	0.21	0.22	0.22	0.23	0.23	0.24	0.25	0.26	0.27	0.28	0.29	0.30	0.32	0.33	0.34	0.36	0.37	0.39	0.41	0.42	0.44	0.46	0.47
	20																								
21	0.21	0.22	0.22	0.23	0.23	0.24	0.25	0.26	0.27	0.28	0.29	0.30	0.31	0.32	0.34	0.36	0.37	0.38	0.40	0.41	0.43	0.44	0.46	0.48	
22	0.44	0.45	0.46	0.47	0.48	0.49	0.51	0.52	0.54	0.56	0.59	0.61	0.63	0.66	0.69	0.71	0.74	0.77	0.80	0.83	0.87	0.90	0.93	0.97	
23	0.68	0.70	0.71	0.72	0.74	0.76	0.78	0.80	0.83	0.86	0.90	0.93	0.96	1.00	1.03	1.08	1.13	1.17	1.22	1.26	1.31	1.37	1.41	1.46	
24	0.93	0.96	0.97	0.99	1.01	1.03	1.06	1.10	1.13	1.18	1.22	1.26	1.31	1.36	1.41	1.47	1.52	1.58	1.64	1.71	1.77	1.84	1.90	1.97	
25	1.19	1.23	1.25	1.27	1.29	1.32	1.36	1.40	1.45	1.50	1.55	1.61	1.67	1.73	1.80	1.86	1.93	2.00	2.08	2.16	2.24	2.32	2.40	2.48	
26	1.47	1.51	1.53	1.56	1.59	1.62	1.67	1.72	1.77	1.83	1.90	1.96	2.03	2.11	2.19	2.27	2.35	2.44	2.53	2.62	2.72	2.81	2.91	3.01	
27	1.75	1.80	1.82	1.85	1.89	1.93	1.98	2.04	2.11	2.18	2.25	2.33	2.41	2.50	2.59	2.68	2.78	2.88	2.98	3.09	3.20	3.31	3.42	3.53	
28	2.04	2.10	2.13	2.16	2.20	2.25	2.31	2.38	2.45	2.53	2.62	2.70	2.80	2.89	3.00	3.10	3.21	3.32	3.45	3.57	3.69	3.82	3.94	4.07	
29	2.34	2.41	2.44	2.48	2.53	2.58	2.65	2.72	2.81	2.89	2.99	3.09	3.19	3.30	3.42	3.53	3.65	3.78	3.92	4.05	4.19	4.33	4.47	4.61	
30	2.66	2.73	2.77	2.81	2.86	2.92	3.00	3.08	3.17	3.27	3.37	3.48	3.59	3.72	3.84	3.97	4.11	4.25	4.40	4.55	4.70	4.85	4.92	5.17	

Note: This table can be used to convert the density d_{20}^t to d_{20}^{20}

COMPENDIUM OF INTERNATIONAL METHODS OF ANALYSIS - OIV
Density and Specific Gravity – Type I and IV methods

TABLE III

Temperature corrections, *c*, required for the density of natural or concentrated musts, measured using a Pyrex-glass pycnometer at *t* °C, in order to correct to 20 °C

$$\rho_{20} = \rho_t \pm \frac{c}{1000} \begin{array}{l} - \text{if } t \text{ }^\circ\text{C is lower than } 20 \text{ }^\circ\text{C} \\ + \text{if } t \text{ }^\circ\text{C is higher than } 20 \text{ }^\circ\text{C} \end{array}$$

		Density																					
		1.05	1.06	1.07	1.08	1.09	1.10	1.11	1.12	1.13	1.14	1.15	1.16	1.18	1.20	1.22	1.24	1.26	1.28	1.30	1.32	1.34	1.36
Temperature in °C	10	2.31	2.48	2.66	2.82	2.99	3.13	3.30	3.44	3.59	3.73	3.88	4.01	4.28	4.52	4.76	4.98	5.18	5.42	5.56	5.73	5.90	6.05
	11	2.12	2.28	2.42	2.57	2.72	2.86	2.99	3.12	3.25	3.37	3.50	3.62	3.85	4.08	4.29	4.148	4.67	4.84	5.00	5.16	5.31	5.45
	12	1.92	2.06	2.19	2.32	2.45	2.58	2.70	2.92	2.94	3.04	3.15	3.26	3.47	3.67	3.85	4.03	4.20	4.36	4.51	4.65	4.78	4.91
	13	1.72	1.84	1.95	2.06	2.17	2.27	2.38	2.48	2.58	2.69	2.78	2.89	3.05	3.22	3.39	3.55	3.65	3.84	3.98	4.11	4.24	4.36
	14	1.52	1.62	1.72	1.81	1.90	2.00	2.09	2.17	2.26	2.34	2.43	2.51	2.66	2.82	2.96	3.09	3.22	3.34	3.45	3.56	3.67	3.76
	15	1.28	1.36	1.44	1.52	1.60	1.67	1.75	1.82	1.89	1.96	2.04	2.11	2.24	2.36	2.48	2.59	2.69	2.79	2.88	2.97	3.03	3.10
	16	1.05	1.12	1.18	1.25	1.31	1.37	1.43	1.49	1.55	1.60	1.66	1.71	1.81	1.90	2.00	2.08	2.16	2.24	2.30	2.37	2.43	2.49
	17	0.80	0.86	0.90	0.95	1.00	1.04	1.09	1.13	1.18	1.22	1.26	1.30	1.37	1.44	1.51	1.57	1.62	1.68	1.72	1.76	1.80	1.84
	18	0.56	0.59	0.62	0.66	0.68	0.72	0.75	0.77	0.80	0.83	0.85	0.88	0.93	0.98	1.02	1.05	1.09	1.12	1.16	1.19	1.21	1.24
	19	0.29	0.31	0.32	0.34	0.36	0.37	0.39	0.40	0.42	0.43	0.44	0.45	0.48	0.50	0.52	0.54	0.56	0.57	0.59	0.60	0.61	0.62
	20																						
	21	0.29	0.30	0.32	0.34	0.35	0.37	0.38	0.40	0.41	0.42	0.44	0.46	0.48	0.50	0.53	0.56	0.58	0.59	0.60	0.61	0.62	0.62
	22	0.58	0.61	0.64	0.67	0.70	0.73	0.76	0.79	0.81	0.84	0.87	0.90	0.96	1.03	1.05	1.09	1.12	1.15	1.18	1.20	1.22	1.23
	23	0.89	0.94	0.99	1.03	1.08	1.12	1.16	1.20	1.25	1.29	1.33	1.37	1.44	1.51	1.57	1.63	1.67	1.73	1.77	1.80	1.82	1.94
	24	1.20	1.25	1.31	1.37	1.43	1.49	1.54	1.60	1.66	1.71	1.77	1.82	1.92	2.01	2.10	2.17	2.24	2.30	2.36	2.40	2.42	2.44
	25	1.51	1.59	1.66	1.74	1.81	1.88	1.95	2.02	2.09	2.16	2.23	2.30	2.42	2.53	2.63	2.72	2.82	2.89	2.95	2.99	3.01	3.05
	26	1.84	1.92	2.01	2.10	2.18	2.26	2.34	2.42	2.50	2.58	2.65	2.73	2.87	3.00	3.13	3.25	3.36	3.47	3.57	3.65	3.72	3.79
	27	2.17	2.26	2.36	2.46	2.56	2.66	2.75	2.84	2.93	3.01	3.10	3.18	3.35	3.50	3.66	3.80	3.93	4.06	4.16	4.26	4.35	4.42
	28	2.50	2.62	2.74	2.85	2.96	3.07	3.18	3.28	3.40	3.50	3.60	3.69	3.87	4.04	4.21	4.36	4.50	4.64	4.75	4.86	4.94	5.00
	29	2.86	2.98	3.10	3.22	3.35	3.47	3.59	3.70	3.82	3.93	4.03	4.14	4.34	4.53	4.72	4.89	5.05	5.20	5.34	5.46	5.56	5.64
30	3.20	3.35	3.49	3.64	3.77	3.91	4.05	4.17	4.30	4.43	4.55	4.67	4.90	5.12	5.39	5.51	5.68	5.94	5.96	6.09	6.16	6.22	

Note: This table can be used to convert the density d_{20}^t to d_{20}^{20}

COMPENDIUM OF INTERNATIONAL METHODS OF ANALYSIS - OIV
Density and Specific Gravity – Type I and IV methods

TABLE IV

Temperature corrections, *c*, required for the density of liqueur wines,

measured using a Pyrex-glass pycnometer at *t* °C, in order to correct to 20 °C

$$\rho_{20} = \rho_t \pm \frac{c}{1000} \cdot \frac{1}{\rho_t} \quad \begin{array}{l} - \text{if } t \text{ }^\circ\text{C is lower than } 20 \text{ }^\circ\text{C} \\ + \text{if } t \text{ }^\circ\text{C is higher than } 20 \text{ }^\circ\text{C} \end{array}$$

		13% vol. wines							15% vol. wines							17% vol. wines						
		Density							Density							Density						
		1.000	1.020	1.040	1.060	1.080	1.100	1.120	1.000	1.020	1.040	1.060	1.080	1.100	1.120	1.000	1.020	1.040	1.060	1.080	1.100	1.120
Temperature in °C	10	2.36	2.71	3.06	3.42	3.72	3.96	4.32	2.64	2.99	3.36	3.68	3.99	4.30	4.59	2.94	3.29	3.64	3.98	4.29	4.60	4.89
	11	2.17	2.49	2.80	2.99	3.39	3.65	3.90	2.42	2.73	3.05	3.34	3.63	3.89	4.15	2.69	3.00	3.32	3.61	3.90	4.16	4.41
	12	1.97	2.25	2.53	2.79	3.05	3.29	3.52	2.19	2.47	2.75	3.01	3.27	3.51	3.73	2.42	2.70	2.98	3.24	3.50	3.74	3.96
	13	1.78	2.02	2.25	2.47	2.69	2.89	3.09	1.97	2.21	2.44	2.66	2.87	3.08	3.29	2.18	2.42	2.64	2.87	3.08	3.29	3.49
	14	1.57	1.78	1.98	2.16	2.35	2.53	2.70	1.74	1.94	2.14	2.32	2.52	2.69	2.86	1.91	2.11	2.31	2.50	2.69	2.86	3.03
	15	1.32	1.49	1.66	1.82	1.97	2.12	2.26	1.46	1.63	1.79	1.95	2.10	2.25	2.39	1.60	1.77	1.93	2.09	2.24	2.39	2.53
	16	1.08	1.22	1.36	1.48	1.61	1.73	1.84	1.18	1.32	1.46	1.59	1.71	1.83	1.94	1.30	1.44	1.58	1.71	1.83	1.95	2.06
	17	0.83	0.94	1.04	1.13	1.22	1.31	1.40	0.91	1.02	1.12	1.21	1.30	1.39	1.48	1.00	1.10	1.20	1.30	1.39	1.48	1.56
	18	0.58	0.64	0.71	0.78	0.84	0.89	0.95	0.63	0.69	0.76	0.83	0.89	0.94	1.00	0.69	0.75	0.82	0.89	0.95	1.00	1.06
	19	0.30	0.34	0.37	0.40	0.43	0.46	0.49	0.33	0.37	0.40	0.43	0.46	0.49	0.52	0.36	0.39	0.42	0.46	0.49	0.52	0.54
	20																					
21	0.30	0.33	0.36	0.40	0.43	0.46	0.49	0.33	0.36	0.39	0.43	0.46	0.49	0.51	0.35	0.39	0.42	0.45	0.48	0.51	0.54	
22	0.60	0.67	0.73	0.80	0.85	0.91	0.98	0.65	0.72	0.78	0.84	0.90	0.96	1.01	0.71	0.78	0.84	0.90	0.96	1.01	1.07	
23	0.93	1.02	1.12	1.22	1.30	1.39	1.49	1.01	1.10	1.20	1.29	1.38	1.46	1.55	1.10	1.19	1.29	1.38	1.46	1.55	1.63	
24	1.27	1.39	1.50	1.61	1.74	1.84	1.95	1.37	1.49	1.59	1.72	1.84	1.95	2.06	1.48	1.60	1.71	1.83	1.95	2.06	2.17	
25	1.61	1.75	1.90	2.05	2.19	2.33	2.47	1.73	1.87	2.02	2.17	2.31	2.45	2.59	1.87	2.01	2.16	2.31	2.45	2.59	2.73	
26	1.94	2.12	2.29	2.47	2.63	2.79	2.95	2.09	2.27	2.44	2.62	2.78	2.94	3.10	2.26	2.44	2.61	2.79	2.95	3.11	3.26	
27	2.30	2.51	2.70	2.90	3.09	3.27	3.44	2.48	2.68	2.87	3.07	3.27	3.45	3.62	2.67	2.88	3.07	3.27	3.46	3.64	3.81	
28	2.66	2.90	3.13	3.35	3.57	3.86	4.00	2.86	3.10	3.23	3.55	3.77	3.99	4.20	3.08	3.31	3.55	3.76	3.99	4.21	4.41	
29	3.05	3.31	3.56	3.79	4.04	4.27	4.49	3.28	3.53	3.77	4.02	4.26	4.49	4.71	3.52	3.77	4.01	4.26	4.50	4.73	4.95	
30	3.44	3.70	3.99	4.28	4.54	4.80	5.06	3.68	3.94	4.23	4.52	4.79	5.05	5.30	3.95	4.22	4.51	4.79	5.07	5.32	5.57	

COMPENDIUM OF INTERNATIONAL METHODS OF ANALYSIS - OIV
Density and Specific Gravity – Type I and IV methods

TABLE IV (continued)

Temperature corrections, *c*, required for the density of liqueur wines,
 measured using a Pyrex-glass pycnometer at *t* °C, in order to correct to 20 °C

$$\rho_{20} = \frac{c}{1000} \begin{array}{l} - \text{if } t \text{ }^\circ\text{C is lower than } 20 \text{ }^\circ\text{C} \\ + \text{if } t \text{ }^\circ\text{C is higher than } 20 \text{ }^\circ\text{C} \end{array}$$

Temperature in °C	19% vol. wines							21% vol. wines						
	Density							Density						
	1.000	1.020	1.040	1.060	1.000	1.100	1.120	1.000	1.020	1.040	1.060	1.080	1.100	1.120
10	3.27	3.62	3.97	4.30	4.62	4.92	5.21	3.62	3.97	4.32	4.66	4.97	5.27	5.56
11	2.99	3.30	3.61	3.90	4.19	4.45	4.70	3.28	3.61	3.92	4.22	4.50	4.76	5.01
12	2.68	2.96	3.24	3.50	3.76	4.00	4.21	2.96	3.24	3.52	3.78	4.03	4.27	4.49
13	2.68	2.96	3.24	3.50	3.76	4.00	4.21	2.96	3.24	3.52	3.78	4.03	4.27	4.49
14	2.11	2.31	2.51	2.69	2.88	3.05	3.22	2.31	2.51	2.71	2.89	3.08	3.25	3.43
15	1.76	1.93	2.09	2.25	2.40	2.55	2.69	1.93	2.10	2.26	2.42	2.57	2.72	2.86
16	1.43	1.57	1.70	1.83	1.95	2.08	2.18	1.56	1.70	1.84	1.97	2.09	2.21	2.32
17	1.09	1.20	1.30	1.39	1.48	1.57	1.65	1.20	1.31	1.41	1.50	1.59	1.68	1.77
18	0.76	0.82	0.88	0.95	1.01	1.06	1.12	0.82	0.88	0.95	1.01	1.08	1.13	1.18
19	0.39	0.42	0.45	0.49	0.52	0.55	0.57	0.42	0.46	0.49	0.52	0.55	0.58	0.61
20														
21	0.38	0.42	0.45	0.48	0.51	0.54	0.57	0.41	0.45	0.48	0.51	0.54	0.57	0.60
22	0.78	0.84	0.90	0.96	1.02	1.07	1.13	0.84	0.90	0.96	1.02	1.08	1.14	1.19
23	1.19	1.28	1.38	1.47	1.55	1.64	1.72	1.29	1.39	1.48	1.57	1.65	1.74	1.82
24	1.60	1.72	1.83	1.95	2.06	2.18	2.29	1.73	1.85	1.96	2.08	2.19	2.31	2.42
25	2.02	2.16	2.31	2.46	2.60	2.74	2.88	2.18	2.32	2.47	2.62	2.76	2.90	3.04
26	2.44	2.62	2.79	2.96	3.12	3.28	3.43	2.53	2.81	2.97	3.15	3.31	3.47	3.62
27	2.88	3.08	3.27	3.42	3.66	3.84	4.01	3.10	3.30	3.47	3.69	3.88	4.06	4.23
28	3.31	3.54	3.78	4.00	4.22	4.44	4.64	3.56	3.79	4.03	4.25	4.47	4.69	4.89
29	3.78	4.03	4.27	4.52	4.76	4.99	5.21	4.06	4.31	4.55	4.80	5.04	5.27	5.48
30	4.24	4.51	4.80	5.08	5.36	5.61	5.86	4.54	4.82	5.11	5.39	5.66	5.91	6.16

COMPENDIUM OF INTERNATIONAL METHODS OF ANALYSIS - OIV
Density and Specific Gravity – Type I and IV methods

TABLE V

Temperature corrections, c , required for the density of dry wines and dealcoholised dry wines, measured using an ordinary-glass pycnometer or hydrometer at t °C, in order to correct to 20 °C

$$\rho_{20} = \rho_t \pm \frac{c}{1000} \quad \begin{array}{l} - \text{ if } t \text{ }^\circ\text{C is lower than } 20 \text{ }^\circ\text{C} \\ + \text{ if } t \text{ }^\circ\text{C is higher than } 20 \text{ }^\circ\text{C} \end{array}$$

		Alcoholic strength																								
		0	5	6	7	8	9	10	11	12	13	14	15	16	17	18	19	20	21	22	23	24	25	26	27	
Temperature in °C	10	1.45	1.51	1.55	1.58	1.64	1.76	1.78	1.89	1.98	2.09	2.21	2.34	2.47	2.60	2.75	2.93	3.06	3.22	3.39	3.57	3.75	3.93	4.12	4.31	
	11	1.35	1.40	1.43	1.47	1.52	1.58	1.65	1.73	1.83	1.93	2.03	2.15	2.26	2.38	2.51	2.65	2.78	2.93	3.08	3.24	3.40	3.57	3.73	3.90	
	12	1.24	1.28	1.31	1.34	1.39	1.44	1.50	1.58	1.66	1.75	1.84	1.94	2.04	2.15	2.26	2.38	2.51	2.63	2.77	2.91	3.05	3.19	3.34	3.49	
	13	1.12	1.16	1.18	1.21	1.25	1.30	1.35	1.42	1.49	1.56	1.64	1.73	1.82	1.91	2.01	2.11	2.22	2.33	2.45	2.57	2.69	2.81	2.95	3.07	
	14	0.99	1.03	1.05	1.07	1.11	1.14	1.19	1.24	1.31	1.37	1.44	1.52	1.59	1.67	1.75	1.84	1.93	2.03	2.13	2.23	2.33	2.44	2.55	2.66	
	15	0.86	0.89	0.90	0.92	0.95	0.98	1.02	1.07	1.12	1.17	1.23	1.29	1.35	1.42	1.49	1.56	1.63	1.71	1.80	1.88	1.96	2.05	2.14	2.23	
	16	0.71	0.73	0.74	0.76	0.78	0.81	0.84	0.87	0.91	0.95	0.99	1.05	1.10	1.15	1.21	1.27	1.33	1.39	1.45	1.52	1.59	1.66	1.73	1.80	
	17	0.55	0.57	0.57	0.59	0.60	0.62	0.65	0.67	0.70	0.74	0.77	0.81	0.84	0.88	0.92	0.96	1.01	1.05	1.10	1.15	1.20	1.26	1.31	1.36	
	18	0.38	0.39	0.39	0.40	0.41	0.43	0.44	0.46	0.48	0.50	0.52	0.55	0.57	0.60	0.62	0.65	0.68	0.71	0.74	0.78	0.81	0.85	0.88	0.91	
	19	0.19	0.20	0.20	0.21	0.21	0.22	0.23	0.24	0.25	0.26	0.27	0.28	0.29	0.30	0.32	0.33	0.34	0.36	0.38	0.39	0.41	0.43	0.44	0.46	
	20																									
	21	0.21	0.22	0.22	0.23	0.23	0.24	0.25	0.25	0.26	0.27	0.28	0.29	0.31	0.32	0.34	0.35	0.36	0.38	0.39	0.41	0.43	0.44	0.46	0.48	
	22	0.43	0.45	0.45	0.46	0.47	0.49	0.50	0.52	0.54	0.56	0.58	0.60	0.62	0.65	0.68	0.71	0.73	0.77	0.80	0.83	0.86	0.89	0.93	0.96	
	23	0.67	0.69	0.70	0.71	0.72	0.74	0.77	0.79	0.82	0.85	0.88	0.91	0.95	0.99	1.03	1.07	1.12	1.16	1.21	1.25	1.30	1.35	1.40	1.45	
	24	0.91	0.93	0.95	0.97	0.99	1.01	1.04	1.07	1.11	1.15	1.20	1.24	1.29	1.34	1.39	1.45	1.50	1.56	1.62	1.69	1.76	1.82	1.88	1.95	
25	1.16	1.19	1.21	1.23	1.26	1.29	1.33	1.37	1.42	1.47	1.52	1.57	1.63	1.70	1.76	1.83	1.90	1.97	2.05	2.13	2.21	2.29	2.37	2.45		
26	1.42	1.46	1.49	1.51	1.54	1.58	1.62	1.67	1.73	1.79	1.85	1.92	1.99	2.07	2.14	2.22	2.31	2.40	2.49	2.58	2.67	2.77	2.86	2.96		
27	1.69	1.74	1.77	1.80	1.83	1.88	1.93	1.98	2.05	2.12	2.20	2.27	2.35	2.44	2.53	2.63	2.72	2.82	2.93	3.04	3.14	3.25	3.37	3.48		
28	1.97	2.03	2.06	2.09	2.14	2.19	2.24	2.31	2.38	2.46	2.55	2.63	2.73	2.83	2.93	3.03	3.14	3.26	3.38	3.50	3.62	3.75	3.85	4.00		
29	2.26	2.33	2.37	2.41	2.45	2.50	2.57	2.64	2.73	2.82	2.91	2.99	3.11	3.22	3.34	3.46	3.58	3.70	3.84	3.97	4.11	4.25	4.39	4.54		
30	2.56	2.64	2.67	2.72	2.77	2.83	2.90	2.98	3.08	3.18	3.28	3.38	3.50	3.62	3.75	3.88	4.02	4.16	4.30	4.46	4.61	4.76	4.92	5.07		

Note: This table can be used to convert the density d_{20}^t to d_{20}^{20}

COMPENDIUM OF INTERNATIONAL METHODS OF ANALYSIS - OIV
Density and Specific Gravity – Type I and IV methods

TABLE VI

Temperature corrections, *c*, required for the density of concentrated musts,
 measured using an ordinary-glass pycnometer or hydrometer at *t* °C, in order to correct to 20 °C.

$$\rho_{20} = \rho_t \pm \frac{c}{1000} \quad \text{– if } t \text{ }^\circ\text{C is lower than } 20 \text{ }^\circ\text{C}$$

		Density																					
		1.05	1.06	1.07	1.08	1.09	1.10	1.11	1.12	1.13	1.14	1.15	1.16	1.18	1.20	1.22	1.24	1.26	1.28	1.30	1.32	1.34	1.36
Temperature in °C	10	2.17	2.34	2.52	2.68	2.85	2.99	3.16	3.29	3.44	3.58	3.73	3.86	4.13	4.36	4.60	4.82	5.02	5.25	5.39	5.56	-5.73	5.87
	11	2.00	2.16	2.29	2.44	2.59	2.73	2.86	2.99	3.12	3.24	3.37	3.48	3.71	3.94	4.15	4.33	4.52	4.69	4.85	5.01	5.15	5.29
	12	1.81	1.95	2.08	2.21	2.34	2.47	2.58	2.70	2.82	2.92	3.03	3.14	3.35	3.55	3.72	3.90	4.07	4.23	4.37	4.52	4.64	4.77
	13	1.62	1.74	1.85	1.96	2.07	2.17	2.28	2.38	2.48	2.59	2.68	2.77	2.94	3.11	3.28	3.44	3.54	3.72	3.86	3.99	4.12	4.24
	14	1.44	1.54	1.64	1.73	1.82	1.92	2.00	2.08	2.17	2.25	2.34	2.42	2.57	2.73	2.86	2.99	3.12	3.24	3.35	3.46	3.57	3.65
	15	1.21	1.29	1.37	1.45	1.53	1.60	1.68	1.75	1.82	1.89	1.97	2.03	2.16	2.28	2.40	2.51	2.61	2.71	2.80	2.89	2.94	3.01
	16	1.00	1.06	1.12	1.19	1.25	1.31	1.37	1.43	1.49	1.54	1.60	1.65	1.75	1.84	1.94	2.02	2.09	2.17	2.23	2.30	2.36	2.42
	17	0.76	0.82	0.86	0.91	0.96	1.00	1.05	1.09	1.14	1.18	1.22	1.25	1.32	1.39	1.46	1.52	1.57	1.63	1.67	1.71	1.75	1.79
	18	0.53	0.56	0.59	0.63	0.65	0.69	0.72	0.74	0.77	0.80	0.82	0.85	0.90	0.95	0.99	1.02	1.05	1.09	1.13	1.16	1.18	1.20
	19	0.28	0.30	0.31	0.33	0.35	0.36	0.38	0.39	0.41	0.42	0.43	0.43	0.46	0.48	0.50	0.52	0.54	0.55	0.57	0.58	0.59	0.60
	20																						
21	0.28	0.29	0.31	0.33	0.34	0.36	0.37	0.39	0.40	0.41	0.43	0.44	0.46	0.48	0.51	0.54	0.56	0.57	0.58	0.59	0.60	0.60	0.60
22	0.55	0.58	0.61	0.64	0.67	0.70	0.73	0.76	0.78	0.81	0.84	0.87	0.93	0.97	1.02	1.06	1.09	1.12	1.15	1.17	1.19	1.19	1.19
23	0.85	0.90	0.95	0.99	1.04	1.08	1.12	1.16	1.21	1.25	1.29	1.32	1.39	1.46	1.52	1.58	1.62	1.68	1.72	1.75	1.77	1.79	1.79
24	1.15	1.19	1.25	1.31	1.37	1.43	1.48	1.54	1.60	1.65	1.71	1.76	1.86	1.95	2.04	2.11	2.17	2.23	2.29	2.33	2.35	2.37	2.37
25	1.44	1.52	1.59	1.67	1.74	1.81	1.88	1.95	2.02	2.09	2.16	2.22	2.34	2.45	2.55	2.64	2.74	2.81	7.87	2.90	2.92	2.96	2.96
26	1.76	1.84	1.93	2.02	2.10	2.18	2.25	2.33	2.41	2.49	2.56	2.64	2.78	2.91	3.03	3.15	3.26	3.37	3.47	3.55	3.62	3.60	3.60
27	2.07	2.16	2.26	2.36	2.46	2.56	2.65	2.74	2.83	2.91	3.00	3.07	3.24	3.39	3.55	3.69	3.82	3.94	4.04	4.14	4.23	4.30	4.30
28	2.39	2.51	2.63	2.74	2.85	2.96	3.06	3.16	3.28	3.38	3.48	3.57	3.75	3.92	4.08	4.23	4.37	4.51	4.62	4.73	4.80	4.86	4.86
29	2.74	2.86	2.97	3.09	3.22	3.34	3.46	3.57	3.69	3.90	3.90	4.00	4.20	4.39	4.58	4.74	4.90	5.05	5.19	5.31	5.40	5.48	5.48
30	3.06	3.21	3.35	3.50	3.63	3.77	3.91	4.02	4.15	4.28	4.40	4.52	4.75	4.96	5.16	5.35	5.52	5.67	5.79	5.91	5.99	6.04	6.04

1000 + if *t* °C is higher than 20 °C

COMPENDIUM OF INTERNATIONAL METHODS OF ANALYSIS - OIV
Density and Specific Gravity – Type I and IV methods

$$\rho_{20} = \rho_t \pm \frac{c}{1000}$$

Note: This table can be used to convert the density d_{20}^t to d_{20}^{20}

TABLE VII

Temperature corrections, c , required for the density of liqueur wines,
 measured using an ordinary-glass pycnometer or hydrometer at t °C, in order to correct to 20 °C
 – if t °C is lower than 20 °C
 + if t °C is higher than 20 °C

		13% vol. wines							15% vol. wines							17% vol. wines						
		Density							Density							Density						
		1.000	1.020	1.040	1.060	1.080	1.100	1.120	1.000	1.020	1.040	1.060	1.080	1.100	1.120	1.000	1.020	1.040	1.060	1.080	1.100	1.120
T _e	10	2.24	2.58	2.93	3.27	3.59	3.89	4.18	2.51	2.85	3.20	3.54	3.85	4.02	4.46	2.81	3.15	3.50	3.84	4.15	4.45	4.74
	11	2.06	2.37	2.69	2.97	3.26	3.53	3.78	2.31	2.61	2.93	3.21	3.51	3.64	4.02	2.57	2.89	3.20	3.49	3.77	4.03	4.28

COMPENDIUM OF INTERNATIONAL METHODS OF ANALYSIS - OIV
Density and Specific Gravity – Type I and IV methods

12	1.87	2.14	2.42	2.67	2.94	3.17	3.40	2.09	2.36	2.64	2.90	3.16	3.27	3.61	2.32	2.60	2.87	3.13	3.39	3.63	3.84	
13	1.69	1.93	2.14	2.37	2.59	2.80	3.00	1.88	2.12	2.34	2.56	2.78	2.88	3.19	2.09	2.33	2.55	2.77	2.98	3.19	3.39	
14	1.49	1.70	1.90	2.09	2.27	2.44	2.61	1.67	1.86	2.06	2.25	2.45	2.51	2.77	1.83	2.03	2.23	2.42	2.61	2.77	2.94	
15	1.25	1.42	1.56	1.75	1.90	2.05	2.19	1.39	1.56	1.72	1.88	2.03	2.11	2.32	1.54	1.71	1.87	2.03	2.18	2.32	2.47	
16	1.03	1.17	$\rho_{20} = \rho_t \pm \frac{c}{1000}$.67	1.78	1.06	1.27	1.40	1.53	1.65	1.77	1.88	1.25	1.39	1.52	1.65	1.77	1.89	2.00
17	0.80	0.90	1.00	1.09	1.17	1.27	1.36	0.87	0.98	1.08	1.17	1.26	1.35	1.44	0.96	1.06	1.16	1.26	1.35	1.44	1.52	
18	0.54	0.61	0.68	0.75	0.81	0.86	0.92	0.60	0.66	0.73	0.80	0.85	0.91	0.97	0.66	0.72	0.79	0.86	0.92	0.97	1.03	
19	0.29	0.33	0.36	0.39	0.42	0.45	0.48	0.32	0.36	0.39	0.42	0.45	0.48	0.51	0.35	0.38	0.41	0.45	0.48	0.51	0.53	
20																						
21	0.29	0.32	0.35	0.39	0.42	0.45	0.47	0.32	0.35	0.38	0.42	0.45	0.48	0.50	0.34	0.38	0.41	0.44	0.47	0.50	0.53	
22	0.57	0.64	0.70	0.76	0.82	0.88	0.93	0.63	0.69	0.75	0.81	0.87	0.93	0.99	0.68	0.75	0.81	0.87	0.93	0.99	1.04	
23	0.89	0.98	1.08	1.17	1.26	1.34	1.43	0.97	1.06	1.16	1.25	1.34	1.42	1.51	1.06	1.15	1.25	1.34	1.42	1.51	1.59	
24	1.22	1.34	1.44	1.56	1.68	1.79	1.90	1.32	1.44	1.54	1.66	1.78	1.89	2.00	1.43	1.56	1.65	1.77	1.89	2.00	2.11	
25	1.61	1.68	1.83	1.98	2.12	2.26	2.40	1.66	1.81	1.96	2.11	2.25	2.39	2.52	1.80	1.94	2.09	2.24	2.39	2.52	2.66	
26	1.87	2.05	2.22	2.40	2.56	2.71	2.87	2.02	2.20	2.37	2.54	2.70	2.85	3.01	2.18	2.36	2.53	2.71	2.86	3.02	3.17	
27	2.21	2.42	2.60	2.80	3.00	3.18	3.35	2.39	2.59	2.78	2.98	3.17	3.35	3.52	2.58	2.78	2.97	3.17	3.36	3.54	3.71	
28	2.56	2.80	3.02	3.25	3.47	3.67	3.89	2.75	2.89	3.22	3.44	3.66	3.96	4.07	2.97	3.21	3.44	3.66	3.88	4.09	4.30	
29	2.93	3.19	3.43	3.66	3.91	4.14	4.37	3.16	3.41	3.65	3.89	4.13	4.36	4.59	3.40	3.66	3.89	4.13	4.38	4.61	4.82	
30	3.31	3.57	3.86	4.15	4.41	4.66	4.92	3.55	3.81	4.10	4.38	4.66	4.90	5.16	3.82	4.08	4.37	4.65	4.93	5.17	5.42	

TABLE VII (continued)

Temperature corrections, *c*, required for the density of liqueur wines,
 measured using an ordinary-glass pycnometer or hydrometer at *t* °C, in order to correct to 20 °C.
 – if *t* °C is lower than 20 °C
 + if *t* °C is higher than 20 °C

		19% vol. wines							21% vol. wines						
		Density							Density						
		1.000	1.020	1.040	1.060	1.080	1.100	1.120	1.000	1.020	1.040	1.060	1.080	1.100	1.120
°C	10	3.14	3.48	3.83	4.17	4.48	4.78	5.07	3.50	3.84	4.19	4.52	4.83	5.12	5.41

COMPENDIUM OF INTERNATIONAL METHODS OF ANALYSIS - OIV
Density and Specific Gravity – Type I and IV methods

temperature in °C	11	2.87	3.18	3.49	3.78	4.06	4.32	4.57	3.18	3.49	3.80	4.09	4.34	4.63	4.88
	12	2.58	2.96	3.13	3.39	3.65	3.88	4.10	2.86	3.13	3.41	3.67	3.92	4.15	4.37
	13	2.31	2.55	2.77	2.99	3.20	3.41	3.61	2.56	2.79	3.01	3.23	3.44	3.65	3.85
	14	2.03	2.23	2.43	2.61	2.80	2.96	3.13	2.23	2.43	2.63	2.81	3.00	3.16	3.33
	15	1.69	1.86	2.02	2.18	2.33	2.48	2.62	1.86	2.03	2.19	2.35	2.50	2.65	2.80
	16	1.38	1.52	1.65	1.78	1.90	2.02	2.13	1.51	1.65	1.78	1.91	2.03	2.15	2.26
	17	1.06	1.16	1.26	1.35	1.44	1.53	1.62	1.15	1.25	1.35	1.45	1.54	1.63	1.71
	18	0.73	0.79	0.85	0.92	0.98	1.03	1.09	0.79	0.85	0.92	0.98	1.05	1.10	1.15
	19	0.38	0.41	0.44	0.48	0.51	0.52	0.56	0.41	0.44	0.47	0.51	0.54	0.57	0.59
	20														
	21	0.37	0.41	0.44	0.47	0.50	0.53	0.56	0.41	0.44	0.47	0.51	0.54	0.57	0.59
	22	0.75	0.81	0.87	0.93	0.99	1.04	1.10	0.81	0.88	0.94	1.00	1.06	1.10	1.17
	23	1.15	1.30	1.34	1.43	1.51	1.60	1.68	1.25	1.34	1.44	1.63	1.61	1.70	1.78
	24	1.55	1.67	1.77	1.89	2.00	2.11	2.23	1.68	1.80	1.90	2.02	2.13	2.25	2.36
	25	1.95	2.09	2.24	2.39	2.53	2.67	2.71	2.11	2.25	2.40	2.55	2.69	2.83	2.97
26	2.36	2.54	2.71	2.89	3.04	3.20	3.35	2.55	2.73	2.90	3.07	3.22	3.38	3.54	
27	2.79	2.99	3.18	3.38	3.57	3.75	3.92	3.01	3.20	3.40	3.59	3.78	3.96	4.13	
28	3.20	3.44	3.66	3.89	4.11	4.32	4.53	3.46	3.69	3.93	4.15	4.36	4.58	4.77	
29	3.66	3.92	4.15	4.40	4.64	4.87	5.08	3.95	4.20	4.43	4.68	4.92	5.15	5.36	
30	4.11	4.37	4.66	4.94	5.22	5.46	5.71	4.42	4.68	4.97	5.25	5.53	5.77	6.02	

ANNEX II

Comparison of results for the methods of measurement of density using a frequency oscillator (Method B) and using a hydrostatic balance (Method C)

Using samples with densities between 0.992 and 1.012 g/cm³, the repeatability and reproducibility were measured using an inter-laboratory test. The densities of the different samples as measured using a hydrostatic balance and using electronic densimetry were compared, including the repeatability and reproducibility values derived from the multi-year inter-comparison tests performed on a large scale.

1 Samples

Wines with different densities and alcoholic strengths prepared monthly on an industrial scale, taken from a stock of bottles stored under normal conditions, and supplied anonymously to the laboratories.

2. Laboratories

Laboratories participating in the monthly tests organised by *Unione Italiana Vini* (Verona, Italy) according to ISO 5725 (UNI 9225) regulations and the International Harmonized Protocol for the Proficiency Testing of Analytical Chemical Laboratories produced by the AOAC, ISO and IUPAC, and ISO 43 and ILAC G13 guidelines. An annual report is provided by the above-mentioned organisation to all participants.

3 Apparatus

3.1 An electronic hydrostatic balance (with precision to 5 decimal places), equipped if possible with a data-processing device.

3.2 An electronic densimeter, equipped if possible with an autosampler.

4 Analyses

According to the rules for the validation of methods of analysis, each sample was analysed twice consecutively to determine the alcoholic strength.

5 Results

COMPENDIUM OF INTERNATIONAL METHODS OF ANALYSIS - OIV Density and Specific Gravity – Type I and IV methods

Table 1 shows the results of the measurements obtained by the laboratories using a hydrostatic balance.

Table 2 shows the results obtained by the laboratories using an electronic densimeter.

6 Evaluation of results

6.1 The test results were examined for evidence of individual systemic error ($p < 0.025$) using Cochran's and Grubbs' tests successively, according to the procedures described in the internationally accepted Protocol for the Design, Conduct and Interpretation of Method-Performance Studies.

6.2 Repeatability (r) et reproducibility (R)

Calculations for repeatability (r) and reproducibility (R) as defined by the protocol were carried out on the results remaining after the removal of outliers. When assessing a new method, there is often no validated reference or statutory method to compare precision criteria; 'predicted' levels of precision and therefore used to compare the precision data obtained from collaborative tests. These predicted levels are calculated from the Horwitz formula. Comparison of the test results and the predicted levels give an indication as to whether the method is sufficiently precise for the level of analyte being measured. The Horwitz predicted value is calculated from the Horwitz equation.

$$RSD_R = 2^{(1-0.5 \log C)}$$

where C is the measured concentration of analyte expressed as a decimal (e.g. 1 g/100 g = 0.01).

The Horrat value gives a comparison of the actual precision measured with the precision predicted by the Horwitz formula for the method and at the particular level of concentration of the analyte. It is calculated as follows:

$$HoR = RSD_{R(\text{measured})} / RSD_{R(\text{Horwitz})}$$

6.3 Inter-laboratory reproducibility

A Horrat value of 1 usually indicates satisfactory reproducibility, whereas a value of more than 2 usually indicates unsatisfactory reproducibility, i.e. reproducibility that is too variable for analytical purposes or where the variation obtained is greater than that predicted for the type of method employed. Hor is also calculated and

COMPENDIUM OF INTERNATIONAL METHODS OF ANALYSIS - OIV
Density and Specific Gravity – Type I and IV methods

used to measure intra-laboratory reproducibility, using the following approximation:

$RSD_r(\text{Horwitz}) = 0.66 RSD_R(\text{Horwitz})$ (this assumes the approximation that $r = 0.66 R$)

CrD95 is the critical difference for a 95% probability level. It is calculated according to Resolution OIV-MA-AS1-08.

Table 3 shows the differences between the measurements obtained by laboratories using an electronic densimeter and those using a hydrostatic balance.

6.4 Precision parameters

Table 4 shows the overall averages for the precision parameters calculated from all monthly tests carried out between January 2008 and December 2010

COMPENDIUM OF INTERNATIONAL METHODS OF ANALYSIS - OIV
Density and Specific Gravity – Type I and IV methods

Table 1: Results obtained by laboratories that conducted tests using a hydrostatic balance (HB)

Sample	Average	Total no. of values	No. of selected values	Repeatability	s _r	RSD _r	Hor	Reproducibility	s _R	RSD _R calc	HoR	No. of repet.	CrD95
01/08	0.995491	130	120	0.0001701	0.0000607	0.0061016	0.0046193	0.0005979	0.0002135	0.0214502	0.0107178	2	0.0004141
02/08	1.011475	146	125	0.0004714	0.0001684	0.0166457	0.0126320	0.0008705	0.0003109	0.0307366	0.0153947	2	0.0005686
03/08	0.992473	174	161	0.0001470	0.0000525	0.0052898	0.0040029	0.0004311	0.0001540	0.0155140	0.0077482	2	0.0002959
04/08	0.993147	172	155	0.0002761	0.0000986	0.0099274	0.0075130	0.0005446	0.0001945	0.0195839	0.0097818	2	0.0003595
05/08	1.004836	150	138	0.0001882	0.0000672	0.0066905	0.0050723	0.0007495	0.0002677	0.0266373	0.0133283	2	0.0005215
06/08	0.993992	152	136	0.0001486	0.0000531	0.0053391	0.0040411	0.0005302	0.0001894	0.0190506	0.0095167	2	0.0003675
07/08	0.992447	162	150	0.0002660	0.0000950	0.0095709	0.0072424	0.0006046	0.0002159	0.0217575	0.0108664	2	0.0004063
08/08	0.992210	162	151	0.0002619	0.0000935	0.0094281	0.0071341	0.0006309	0.0002253	0.0227108	0.0113420	2	0.0004265
09/08	1.002600	148	131	0.0001093	0.0000390	0.0038920	0.0029496	0.0007000	0.0002500	0.0249341	0.0124719	2	0.0004919
10/08	0.994482	174	152	0.0001228	0.0000439	0.0044105	0.0033385	0.0004250	0.0001518	0.0152645	0.0076259	2	0.0002942
11/08	0.992010	136	125	0.0000909	0.0000325	0.0032742	0.0024775	0.0004256	0.0001520	0.0153217	0.0076516	2	0.0002975
01/09	0.994184	174	152	0.0001655	0.0000591	0.0059435	0.0044987	0.0005439	0.0001942	0.0195384	0.0097606	2	0.0003756
02/09	0.992266	118	101	0.0001742	0.0000622	0.0062682	0.0047431	0.0005210	0.0001861	0.0187534	0.0093658	2	0.0003580
03/09	0.991886	164	135	0.0001850	0.0000661	0.0066603	0.0050395	0.0004781	0.0001707	0.0172136	0.0085963	2	0.0003251
04/09	0.993632	180	150	0.0001523	0.0000544	0.0054754	0.0041440	0.0004270	0.0001525	0.0153476	0.0076664	2	0.0002922
05/09	1.011061	116	100	0.0003659	0.0001307	0.0129234	0.0098067	0.0008338	0.0002978	0.0294527	0.0147508	2	0.0005605
06/09	0.992063	114	105	0.0002923	0.0001044	0.0105238	0.0079631	0.0005257	0.0001877	0.0189240	0.0094507	2	0.0003418
07/09	0.992708	172	155	0.0002892	0.0001033	0.0104040	0.0078732	0.0006156	0.0002199	0.0221478	0.0110617	2	0.0004106
08/09	0.993064	136	127	0.0002926	0.0001045	0.0105224	0.0079632	0.0007520	0.0002686	0.0270446	0.0135081	2	0.0005112
09/09	1.005285	118	110	0.0002946	0.0001052	0.0104661	0.0079352	0.0007226	0.0002581	0.0256704	0.0128454	2	0.0004892
10/09	0.992905	150	132	0.0002234	0.0000798	0.0080358	0.0060812	0.0004498	0.0001607	0.0161803	0.0080815	2	0.0002978
11/09	0.994016	142	127	0.0001896	0.0000677	0.0068114	0.0051555	0.0004739	0.0001693	0.0170278	0.0085062	2	0.0003214
01/10	0.994734	170	152	0.0002125	0.0000759	0.0076288	0.0057748	0.0005406	0.0001931	0.0194104	0.0096975	2	0.0003672
02/10	0.993177	120	110	0.0002210	0.0000789	0.0079467	0.0060140	0.0005800	0.0002071	0.0208565	0.0104175	2	0.0003950
03/10	0.992799	148	136	0.0002277	0.0000813	0.0081923	0.0061995	0.0015157	0.0005413	0.0545262	0.0272335	2	0.0010657
04/10	0.995420	172	157	0.0002644	0.0000944	0.0094866	0.0071819	0.0006286	0.0002245	0.0225542	0.0112693	2	0.0004244
05/10	1.002963	120	108	0.0007086	0.0002531	0.0252330	0.0191244	0.0013667	0.0004881	0.0486677	0.0243447	2	0.0008991
06/10	0.992546	120	113	0.0001737	0.0000620	0.0062506	0.0047300	0.0005435	0.0001941	0.0195567	0.0097673	2	0.0003744
07/10	0.992831	174	152	0.0003003	0.0001073	0.0108031	0.0081753	0.0006976	0.0002492	0.0250959	0.0125344	2	0.0004699
08/10	0.993184	144	130	0.0001799	0.0000642	0.0064674	0.0048945	0.0005951	0.0002125	0.0213984	0.0106882	2	0.0004111
09/10	1.012293	114	103	0.0002265	0.0000809	0.0079907	0.0060647	0.0014586	0.0005209	0.0514596	0.0257772	2	0.0010251
10/10	0.992289	154	136	0.0006386	0.0002281	0.0229860	0.0173933	0.0007033	0.0002512	0.0253124	0.0126415	2	0.0003812
11/10	0.994649	130	112	0.0002902	0.0001036	0.0104200	0.0078876	0.0005287	0.0001888	0.0189830	0.0094838	2	0.0003445

COMPENDIUM OF INTERNATIONAL METHODS OF ANALYSIS - OIV
Density and Specific Gravity – Type I and IV methods

Table 2: Results obtained by laboratories that conducted tests using an electronic densimeter (ED)

Sample	Average	Total no. of values	No. of selected values	Repeatability	s _r	RSD _r	Hor	Reproducibility	s _R	RSD _R calc	HoR	No. of repet.	CrD95
01/08	0.995504	114	108	0.0000755	0.0000270	0.0027085	0.0020505	0.0001571	0.0000561	0.0056361	0.0028162	2	0.0001045
02/08	1.011493	132	125	0.0001921	0.0000686	0.0067837	0.0051480	0.0004435	0.0001584	0.0156582	0.0078426	2	0.0002985
03/08	0.992491	138	118	0.0000746	0.0000266	0.0026830	0.0020303	0.0002745	0.0000980	0.0098776	0.0049332	2	0.0001905
04/08	0.993129	132	120	0.0001230	0.0000439	0.0044247	0.0033486	0.0002863	0.0001023	0.0102965	0.0051429	2	0.0001929
05/08	1.004892	136	116	0.0000926	0.0000331	0.0032893	0.0024937	0.0004777	0.0001706	0.0169785	0.0084955	2	0.0003346
06/08	0.994063	142	123	0.0000558	0.0000199	0.0020051	0.0015177	0.0001776	0.0000634	0.0063791	0.0031867	2	0.0001224
07/08	0.992498	136	125	0.0000822	0.0000294	0.0029576	0.0022381	0.0002094	0.0000748	0.0075368	0.0037641	2	0.0001423
08/08	0.992270	130	115	0.0000515	0.0000184	0.0018537	0.0014027	0.0001665	0.0000595	0.0059940	0.0029935	2	0.0001149
09/08	1.002603	136	121	0.0000821	0.0000293	0.0029236	0.0022157	0.0003328	0.0001189	0.0118565	0.0059306	2	0.0002318
10/08	0.994493	128	117	0.0000667	0.0000238	0.0023954	0.0018132	0.0001429	0.0000510	0.0051309	0.0025633	2	0.0000954
11/08	0.992017	118	104	0.0000842	0.0000301	0.0030309	0.0022933	0.0001962	0.0000701	0.0070644	0.0035279	2	0.0001322
01/09	0.994216	148	131	0.0000830	0.0000297	0.0029832	0.0022580	0.0001551	0.0000554	0.0055712	0.0027832	2	0.0001015
02/09	0.992251	104	88	0.0000947	0.0000338	0.0034097	0.0025801	0.0002846	0.0001017	0.0102451	0.0051165	2	0.0001956
03/09	0.991875	126	108	0.0001271	0.0000454	0.0045777	0.0034637	0.0002067	0.0000738	0.0074421	0.0037165	2	0.0001316
04/09	0.993654	134	114	0.0001166	0.0000416	0.0041899	0.0031711	0.0002043	0.0000730	0.0073417	0.0036673	2	0.0001322
05/09	1.011035	128	104	0.0002388	0.0000853	0.0084361	0.0064016	0.0003554	0.0001269	0.0125542	0.0062875	2	0.0002211
06/09	0.992104	116	106	0.0001005	0.0000359	0.0036178	0.0027375	0.0003169	0.0001132	0.0114088	0.0056976	2	0.0002184
07/09	0.992720	144	140	0.0001579	0.0000564	0.0056815	0.0042995	0.0002916	0.0001042	0.0104923	0.0052404	2	0.0001905
08/09	0.993139	110	102	0.0001175	0.0000420	0.0042242	0.0031969	0.0003603	0.0001287	0.0129577	0.0064721	2	0.0002479
09/09	1.005276	112	108	0.0001100	0.0000393	0.0039070	0.0029622	0.0003522	0.0001258	0.0125134	0.0062617	2	0.0002429
10/09	0.992912	122	111	0.0000705	0.0000252	0.0025365	0.0019195	0.0002122	0.0000758	0.0076315	0.0038117	2	0.0001458
11/09	0.994031	128	118	0.0000718	0.0000256	0.0025784	0.0019516	0.0001639	0.0000585	0.0058883	0.0029415	2	0.0001102
01/10	0.994752	144	136	0.0000773	0.0000276	0.0027765	0.0021017	0.0001787	0.0000638	0.0064144	0.0032046	2	0.0001203
02/10	0.993181	108	98	0.0001471	0.0000525	0.0052893	0.0040029	0.0001693	0.0000605	0.0060884	0.0030410	2	0.0000945
03/10	0.992665	140	127	0.0001714	0.0000612	0.0061683	0.0046678	0.0002378	0.0000849	0.0085559	0.0042732	2	0.0001447
04/10	0.995502	142	128	0.0001175	0.0000419	0.0042138	0.0031901	0.0002320	0.0000829	0.0083248	0.0041596	2	0.0001532
05/10	1.002851	130	119	0.0001195	0.0000427	0.0042555	0.0032253	0.0002971	0.0001061	0.0105815	0.0052930	2	0.0002014
06/10	0.992607	106	99	0.0001228	0.0000438	0.0044172	0.0033427	0.0002226	0.0000795	0.0080092	0.0040001	2	0.0001449
07/10	0.992871	160	150	0.0001438	0.0000513	0.0051712	0.0039134	0.0003732	0.0001333	0.0134258	0.0067057	2	0.0002539
08/10	0.993235	104	93	0.0000895	0.0000320	0.0032182	0.0024356	0.0002458	0.0000878	0.0088399	0.0044154	2	0.0001680
09/10	1.012328	112	105	0.0000870	0.0000311	0.0030692	0.0023295	0.0003395	0.0001213	0.0119781	0.0060001	2	0.0002361
10/10	0.992308	128	115	0.0000606	0.0000216	0.0021811	0.0016504	0.0001635	0.0000584	0.0058845	0.0029388	2	0.0001116
11/10	0.994683	120	108	0.0001127	0.0000402	0.0040450	0.0030620	0.0001597	0.0000570	0.0057339	0.0028647	2	0.0000979

COMPENDIUM OF INTERNATIONAL METHODS OF ANALYSIS - OIV
Density and Specific Gravity – Type I and IV methods

Table 3: Comparison of results from the hydrostatic balance (BH) and from the electronic densimeter (ED)

Density – Hydrostatic balance				Density – Frequency oscillator				Comparison
Sample	Average value	Total values	Selected values	Sample	Average value	Total values	Selected values	$\Delta(\text{BH-DE})$
01/08	0.995491	130	120	01/08	0.995504	114	108	-0.000013
02/08	1.011475	146	125	02/08	1.011493	132	125	-0.000018
03/08	0.992473	174	161	03/08	0.992491	138	118	-0.000018
04/08	0.993147	172	155	04/08	0.993129	132	120	0.000018
05/08	1.004836	150	138	05/08	1.004892	136	116	-0.000056
06/08	0.993992	152	136	06/08	0.994063	142	123	-0.000071
07/08	0.992447	162	150	07/08	0.992498	136	125	-0.000051
08/08	0.992210	162	151	08/08	0.992270	130	115	-0.000060
09/08	1.002600	148	131	09/08	1.002603	136	121	-0.000003
10/08	0.994482	174	152	10/08	0.994493	128	117	-0.000011
11/08	0.992010	136	125	11/08	0.992017	118	104	-0.000007
01/09	0.994184	174	152	01/09	0.994216	148	131	-0.000031
02/09	0.992266	118	101	02/09	0.992251	104	88	0.000015
03/09	0.991886	164	135	03/09	0.991875	126	108	0.000011
04/09	0.993632	180	150	04/09	0.993654	134	114	-0.000022
05/09	1.011061	116	100	05/09	1.011035	128	104	0.000026
06/09	0.992063	114	105	06/09	0.992104	116	106	-0.000041
07/09	0.992708	172	155	07/09	0.992720	144	140	-0.000012
08/09	0.993064	136	127	08/09	0.993139	110	102	-0.000075
09/09	1.005285	118	110	09/09	1.005276	112	108	0.000009
10/09	0.992905	150	132	10/09	0.992912	122	111	-0.000008
11/09	0.994016	142	127	11/09	0.994031	128	118	-0.000015
01/10	0.994734	170	152	01/10	0.994752	144	136	-0.000018
02/10	0.993177	120	110	02/10	0.993181	108	98	-0.000005
03/10	0.992799	148	136	03/10	0.992665	140	127	0.000134
04/10	0.995420	172	157	04/10	0.995502	142	128	-0.000082
05/10	1.002963	120	108	05/10	1.002851	130	119	0.000112
06/10	0.992546	120	113	06/10	0.992607	106	99	-0.000061
07/10	0.992831	174	152	07/10	0.992871	160	150	-0.000040
08/10	0.993184	144	130	08/10	0.993235	104	93	-0.000052
09/10	1.012293	114	103	09/10	1.012328	112	105	-0.000035
10/10	0.992289	154	136	10/10	0.992308	128	115	-0.000019
11/10	0.994649	130	112	11/10	0.994683	120	108	-0.000035

average	$\Delta(\text{BH-DE})$	-0.0000162
standard deviation	$\Delta(\text{BH-DE})$	0.0000447

Table 4: Precision parameters

	<i>Hydrostatic balance (BH)</i>	<i>Electronic densimeter (ED)</i>
No. of selected values	4347	3800
min	0.99189 g/cm ³	0.99187 g/cm ³
max	1.01229 g/cm ³	1.01233 g/cm ³
R	0.00067 g/cm ³	0.00025 g/cm ³
s_R	0.00024 g/cm ³	0.000091 g/cm ³
R%	0.067%	0.025%
r	0.00025 g/cm ³	0.00011 g/cm ³
s_r	0.000090 g/cm ³	0.000038 g/cm ³
r%	0.025%	0.011%

Key:

n: number of selected values

min: lower limit of the measurement range

max: upper limit of the measurement range

r: repeatability

s_r : repeatability standard deviation

r%: relative repeatability ($r \times 100 / \text{average value}$)

R: reproducibility

s_R : reproducibility standard deviation

R%: relative reproducibility ($R \times 100 / \text{average value}$)

6. BIBLIOGRAPHY

JAULMES, P., *OIV Bulletin*, **26**, No. 274, 1953, p. 6.

JAULMES, P. and BRUN, S., *Trav. Soc. Pharm., Montpellier*, **16**, 1956, p.115;
20, 1960, p. 137; *Ann. Fals. Exp. Chim.*, **46**, 1963, pp. 129 and 143.

BRUN, S. and TEP, Y., *Ann. Fals. Exp. Chim.*, 37-40; OIV, FV, No. 539, 1975.

**Evaluation by refractometry of the sugar concentration
in grape musts, concentrated grape musts and
rectified concentrated grape musts**

OENO 21/2004
OIV/OENO 377/2009
OIV-OENO 466-2012

1 Principle

The refractive index at 20°C, expressed either as an absolute value or as a percentage by mass of sucrose, is given in the appropriate table to provide a means of obtaining the sugar concentration in grams per liter and in grams per kilogram for grape musts, concentrated grape musts and rectified concentrated grape musts.

2 Apparatus

Abbe refractometer

The refractometer used must be fitted with a scale giving:

- either percentage by mass of sucrose to 0.1%;
- or refractive indices to four decimal places.

The refractometer must be equipped with a thermometer having a scale extending at least from +15°C to +25°C and with a system for circulating water that will enable measurements to be made at a temperature of $20 \pm 5^\circ\text{C}$. The operating instructions for this instrument must be strictly adhered to, particularly with regard to calibration and the light source.

3 Preparation of the sample

3.1 Must and concentrated must

Pass the must, if necessary, through a dry gauze folded into four and, after discarding the first drops of the filtrate, carry out the determination on the filtered product.

3.2 Rectified concentrated must

Depending on the concentration, use either the rectified concentrated must itself or a solution obtained by making up 200 g of rectified concentrated must to 500 g with water, all weighings being carried out accurately.

4 Procedure

Bring the sample to a temperature close to 20°C.

Place a small test sample on the lower prism of the refractometer, taking care (because the prisms are pressed firmly against each other) that this test sample

COMPENDIUM OF INTERNATIONAL METHODS OF ANALYSIS –OIV
Evaluation of sugar by refractometry

covers the glass surface uniformly. Carry out the measurement in accordance with the operating instructions of the instrument used.

Read the percentage by mass of sucrose to within 0.1 or read the refractive index to four decimal places.

Carry out at least two determinations on the same prepared sample. Note the temperature $t^{\circ}\text{C}$.

5 Calculation

5.1 Temperature correction

- Instruments graduated in percentage by mass of sucrose: use Table I to obtain the temperature correction.
- Instruments graduated in refractive index: find the index measured at $t^{\circ}\text{C}$ in Table II to obtain (column 1) the corresponding value of the percentage by mass of sucrose at $t^{\circ}\text{C}$. This value is corrected for temperature and expressed as a concentration at 20°C by means of Table I.

5.2 Sugar concentration in must and concentrated must

Find the percentage by mass of sucrose at 20°C in Table II and read from the same row the sugar concentration in grams per liter and grams per kilogram. The sugar concentration is expressed in terms of invert sugar to one decimal place.

5.3 Sugar concentration in rectified concentrated must

Find the percentage by mass of sucrose at 20°C in Table III and read from the same row the sugar concentration in grams per liter and grams per kilogram. The sugar concentration is expressed in terms of invert sugar to one decimal place. If the measurement was made on diluted rectified concentrated must, multiply the result by the dilution factor.

5.4 Refractive index of must, concentrated must and rectified concentrated must

Find the percentage by mass of sucrose at 20°C in Table II and read from the same row the refractive index at 20°C . This index is expressed to four decimal places.

COMPENDIUM OF INTERNATIONAL METHODS OF ANALYSIS –OIV
Evaluation of sugar by refractometry

Table I

Correction to be made in the case where the percentage by mass of saccharose was determined at a temperature different by 20°C.

Temperature °C	Percentage by mass measured in %													
	10	15	20	25	30	35	40	45	50	55	60	65	70	75
5	-0,82	-0,87	-0,92	-0,95	-0,99									
6	-0,80	-0,82	-0,87	-0,90	-0,94									
7	-0,74	-0,78	-0,82	-0,84	-0,88									
8	-0,69	-0,73	-0,76	-0,79	-0,82									
9	-0,64	-0,67	-0,71	-0,73	-0,75									
10	-0,59	-0,62	-0,65	-0,67	-0,69	-0,71	-0,72	-0,73	-0,74	-0,75	-0,75	-0,75	-0,75	-0,75
11	-0,54	-0,57	-0,59	-0,61	-0,63	-0,64	-0,65	-0,66	-0,67	-0,68	-0,68	-0,68	-0,68	-0,67
12	-0,49	-0,51	-0,53	-0,55	-0,56	-0,57	-0,58	-0,59	-0,60	-0,60	-0,61	-0,61	-0,60	-0,60
13	-0,43	-0,45	-0,47	-0,48	-0,50	-0,51	-0,52	-0,52	-0,53	-0,53	-0,53	-0,53	-0,53	-0,53
14	-0,38	-0,39	-0,40	-0,42	-0,43	-0,44	-0,44	-0,45	-0,45	-0,46	-0,46	-0,46	-0,46	-0,45
15	-0,32	-0,33	-0,34	-0,35	-0,36	-0,37	-0,37	-0,38	-0,38	-0,38	-0,38	-0,38	-0,38	-0,38
16	-0,26	-0,27	-0,28	-0,28	-0,29	-0,30	-0,30	-0,30	-0,31	-0,31	-0,31	-0,31	-0,31	-0,30
17	-0,20	-0,20	-0,21	-0,21	-0,22	-0,22	-0,23	-0,23	-0,23	-0,23	-0,23	-0,23	-0,23	-0,23
18	-0,13	-0,14	-0,14	-0,14	-0,15	-0,15	-0,15	-0,15	-0,15	-0,15	-0,15	-0,15	-0,15	-0,15
19	-0,07	-0,07	-0,07	-0,07	-0,07	-0,08	-0,08	-0,08	-0,08	-0,08	-0,08	-0,08	-0,08	-0,08
20	0	R É F É R E N C E												0
21	+0,07	+0,07	+0,07	+0,07	+0,08	+0,08	+0,08	+0,08	+0,08	+0,08	+0,08	+0,08	+0,08	+0,08
22	+0,14	+0,14	+0,15	+0,15	+0,15	+0,15	+0,16	+0,16	+0,16	+0,16	+0,16	+0,16	+0,15	+0,15
23	+0,21	+0,22	+0,22	+0,23	+0,23	+0,23	+0,23	+0,24	+0,24	+0,24	+0,24	+0,23	+0,23	+0,23
24	+0,29	+0,29	+0,30	+0,30	+0,31	+0,31	+0,31	+0,32	+0,32	+0,32	+0,32	+0,31	+0,31	+0,31
25	+0,36	+0,37	+0,38	+0,38	+0,39	+0,39	+0,40	+0,40	+0,40	+0,40	+0,40	+0,39	+0,39	+0,39
26	+0,44	+0,45	+0,46	+0,46	+0,47	+0,47	+0,48	+0,48	+0,48	+0,48	+0,48	+0,47	+0,47	+0,46
27	+0,52	+0,53	+0,54	+0,55	+0,55	+0,56	+0,56	+0,56	+0,56	+0,56	+0,56	+0,55	+0,55	+0,54
28	+0,60	+0,61	+0,62	+0,63	+0,64	+0,64	+0,64	+0,65	+0,65	+0,64	+0,64	+0,64	+0,63	+0,62
29	+0,68	+0,69	+0,70	+0,71	+0,72	+0,73	+0,73	+0,73	+0,73	+0,73	+0,72	+0,72	+0,71	+0,70
30	+0,77	+0,78	+0,79	+0,80	+0,81	+0,81	+0,81	+0,82	+0,81	+0,81	+0,81	+0,80	+0,79	+0,78
31	+0,85	+0,87	+0,88	+0,89	+0,89	+0,90	+0,90	+0,90	+0,90	+0,90	+0,89	+0,88	+0,87	+0,86
32	+0,94	+0,95	+0,96	+0,97	+0,98	+0,99	+0,99	+0,99	+0,99	+0,98	+0,97	+0,96	+0,95	+0,94
33	+1,03	+1,04	+1,05	+1,06	+1,07	+1,08	+1,08	+1,08	+1,07	+1,07	+1,06	+1,05	+1,03	+1,02
34	+1,12	+1,19	+1,15	+1,15	+1,16	+1,17	+1,17	+1,17	+1,16	+1,15	+1,14	+1,13	+1,12	+1,10
35	+1,22	+1,23	+1,24	+1,25	+1,25	+1,26	+1,26	+1,25	+1,25	+1,24	+1,23	+1,21	+1,20	+1,18
36	+1,31	+1,32	+1,33	+1,34	+1,35	+1,35	+1,35	+1,35	+1,34	+1,33	+1,32	+1,30	+1,28	+1,26
37	+1,41	+1,42	+1,43	+1,44	+1,44	+1,44	+1,44	+1,44	+1,43	+1,42	+1,40	+1,38	+1,36	+1,34
38	+1,51	+1,52	+1,53	+1,53	+1,54	+1,54	+1,53	+1,53	+1,52	+1,51	+1,49	+1,47	+1,45	+1,42
39	+1,61	+1,62	+1,62	+1,63	+1,63	+1,63	+1,63	+1,62	+1,61	+1,60	+1,58	+1,56	+1,53	+1,50
40	+1,71	+1,72	+1,72	+1,73	+1,73	+1,73	+1,72	+1,71	+1,70	+1,69	+1,67	+1,64	+1,62	+1,59

It is preferable that the variations in temperature in relation to 20°C do not exceed $\pm 5^\circ\text{C}$.

COMPENDIUM OF INTERNATIONAL METHODS OF ANALYSIS –OIV
Evaluation of sugar by refractometry

TABLE II

Table giving the sugar content of musts and concentrated musts in grammes per litre and in grammes per kilogramme, determined using a graduated refractometer, either in percentage by mass of saccharose at 20°C, or refractive index at 20°C. The mass density at 20°C is also given.

Saccharose % (m/m)	Refractive Index at 20 °C	Mass Density at 20 °C	Sugars in g/l	Sugars in g/kg	ABV % vol at 20 °C
10.0	1.34782	1.0391	82.2	79.1	4.89
10.1	1.34798	1.0395	83.3	80.1	4.95
10.2	1.34813	1.0399	84.3	81.1	5.01
10.3	1.34829	1.0403	85.4	82.1	5.08
10.4	1.34844	1.0407	86.5	83.1	5.14
10.5	1.34860	1.0411	87.5	84.1	5.20
10.6	1.34875	1.0415	88.6	85.0	5.27
10.7	1.34891	1.0419	89.6	86.0	5.32
10.8	1.34906	1.0423	90.7	87.0	5.39
10.9	1.34922	1.0427	91.8	88.0	5.46
11.0	1.34937	1.0431	92.8	89.0	5.52
11.1	1.34953	1.0436	93.9	90.0	5.58
11.2	1.34968	1.0440	95.0	91.0	5.65
11.3	1.34984	1.0444	96.0	92.0	5.71
11.4	1.34999	1.0448	97.1	92.9	5.77
11.5	1.35015	1.0452	98.2	93.9	5.84
11.6	1.35031	1.0456	99.3	94.9	5.90
11.7	1.35046	1.0460	100.3	95.9	5.96
11.8	1.35062	1.0464	101.4	96.9	6.03
11.9	1.35077	1.0468	102.5	97.9	6.09
12.0	1.35093	1.0472	103.5	98.9	6.15
12.1	1.35109	1.0477	104.6	99.9	6.22
12.2	1.35124	1.0481	105.7	100.8	6.28
12.3	1.35140	1.0485	106.8	101.8	6.35
12.4	1.35156	1.0489	107.8	102.8	6.41
12.5	1.35171	1.0493	108.9	103.8	6.47
12.6	1.35187	1.0497	110.0	104.8	6.54
12.7	1.35203	1.0501	111.1	105.8	6.60
12.8	1.35219	1.0506	112.2	106.8	6.67
12.9	1.35234	1.0510	113.2	107.8	6.73
13.0	1.35250	1.0514	114.3	108.7	6.79
13.1	1.35266	1.0518	115.4	109.7	6.86
13.2	1.35282	1.0522	116.5	110.7	6.92
13.3	1.35298	1.0527	117.6	111.7	6.99
13.4	1.35313	1.0531	118.7	112.7	7.05
13.5	1.35329	1.0535	119.7	113.7	7.11
13.6	1.35345	1.0539	120.8	114.7	7.18
13.7	1.35361	1.0543	121.9	115.6	7.24
13.8	1.35377	1.0548	123.0	116.6	7.31
13.9	1.35393	1.0552	124.1	117.6	7.38
14.0	1.35408	1.0556	125.2	118.6	7.44
14.1	1.35424	1.0560	126.3	119.6	7.51
14.2	1.35440	1.0564	127.4	120.6	7.57
14.3	1.35456	1.0569	128.5	121.6	7.64
14.4	1.35472	1.0573	129.6	122.5	7.70
14.5	1.35488	1.0577	130.6	123.5	7.76
14.6	1.35504	1.0581	131.7	124.5	7.83
14.7	1.35520	1.0586	132.8	125.5	7.89
14.8	1.35536	1.0590	133.9	126.5	7.96

COMPENDIUM OF INTERNATIONAL METHODS OF ANALYSIS –OIV
Evaluation of sugar by refractometry

14.9	1.35552	1.0594	135.0	127.5	8.02
------	---------	--------	-------	-------	------

TABLE II - (continued)

Saccharose % (m/m)	Refractive Index at 20 °C	Mass Density at 20 °C	Sugars in g/l	Sugars in g/kg	ABV % vol at 20 °C
15.0	1.35568	1.0598	136.1	128.4	8.09
15.1	1.35584	1.0603	137.2	129.4	8.15
15.2	1.35600	1.0607	138.3	130.4	8.22
15.3	1.35616	1.0611	139.4	131.4	8.28
15.4	1.35632	1.0616	140.5	132.4	8.35
15.5	1.35648	1.0620	141.6	133.4	8.42
15.6	1.35664	1.0624	142.7	134.3	8.48
15.7	1.35680	1.0628	143.8	135.3	8.55
15.8	1.35696	1.0633	144.9	136.3	8.61
15.9	1.35713	1.0637	146.0	137.3	8.68
16.0	1.35729	1.0641	147.1	138.3	8.74
16.1	1.35745	1.0646	148.2	139.3	8.81
16.2	1.35761	1.0650	149.3	140.2	8.87
16.3	1.35777	1.0654	150.5	141.2	8.94
16.4	1.35793	1.0659	151.6	142.2	9.01
16.5	1.35810	1.0663	152.7	143.2	9.07
16.6	1.35826	1.0667	153.8	144.2	9.14
16.7	1.35842	1.0672	154.9	145.1	9.21
16.8	1.35858	1.0676	156.0	146.1	9.27
16.9	1.35874	1.0680	157.1	147.1	9.34
17.0	1.35891	1.0685	158.2	148.1	9.40
17.1	1.35907	1.0689	159.3	149.1	9.47
17.2	1.35923	1.0693	160.4	150.0	9.53
17.3	1.35940	1.0698	161.6	151.0	9.60
17.4	1.35956	1.0702	162.7	152.0	9.67
17.5	1.35972	1.0707	163.8	153.0	9.73
17.6	1.35989	1.0711	164.9	154.0	9.80
17.7	1.36005	1.0715	166.0	154.9	9.87
17.8	1.36021	1.0720	167.1	155.9	9.93
17.9	1.36038	1.0724	168.3	156.9	10.00
18.0	1.36054	1.0729	169.4	157.9	10.07
18.1	1.36070	1.0733	170.5	158.9	10.13
18.2	1.36087	1.0737	171.6	159.8	10.20
18.3	1.36103	1.0742	172.7	160.8	10.26
18.4	1.36120	1.0746	173.9	161.8	10.33
18.5	1.36136	1.0751	175.0	162.8	10.40
18.6	1.36153	1.0755	176.1	163.7	10.47
18.7	1.36169	1.0760	177.2	164.7	10.53
18.8	1.36185	1.0764	178.4	165.7	10.60
18.9	1.36202	1.0768	179.5	166.7	10.67
19.0	1.36219	1.0773	180.6	167.6	10.73
19.1	1.36235	1.0777	181.7	168.6	10.80
19.2	1.36252	1.0782	182.9	169.6	10.87
19.3	1.36268	1.0786	184.0	170.6	10.94
19.4	1.36285	1.0791	185.1	171.5	11.00
19.5	1.36301	1.0795	186.2	172.5	11.07
19.6	1.36318	1.0800	187.4	173.5	11.14
19.7	1.36334	1.0804	188.5	174.5	11.20
19.8	1.36351	1.0809	189.6	175.4	11.27
19.9	1.36368	1.0813	190.8	176.4	11.34

COMPENDIUM OF INTERNATIONAL METHODS OF ANALYSIS –OIV
Evaluation of sugar by refractometry

TABLE II - (continued)

Saccharose % (m/m)	Refractive Index at 20 °C	Mass Density at 20 °C	Sugars in g/l	Sugars in g/kg	ABV % vol at 20 °C
20.0	1.36384	1.0818	191.9	177.4	11.40
20.1	1.36401	1.0822	193.0	178.4	11.47
20.2	1.36418	1.0827	194.2	179.3	11.54
20.3	1.36434	1.0831	195.3	180.3	11.61
20.4	1.36451	1.0836	196.4	181.3	11.67
20.5	1.36468	1.0840	197.6	182.3	11.74
20.6	1.36484	1.0845	198.7	183.2	11.81
20.7	1.36501	1.0849	199.8	184.2	11.87
20.8	1.36518	1.0854	201.0	185.2	11.95
20.9	1.36535	1.0858	202.1	186.1	12.01
21.0	1.36551	1.0863	203.3	187.1	12.08
21.1	1.36568	1.0867	204.4	188.1	12.15
21.2	1.36585	1.0872	205.5	189.1	12.21
21.3	1.36602	1.0876	206.7	190.0	12.28
21.4	1.36619	1.0881	207.8	191.0	12.35
21.5	1.36635	1.0885	209.0	192.0	12.42
21.6	1.36652	1.0890	210.1	192.9	12.49
21.7	1.36669	1.0895	211.3	193.9	12.56
21.8	1.36686	1.0899	212.4	194.9	12.62
21.9	1.36703	1.0904	213.6	195.9	12.69
22.0	1.36720	1.0908	214.7	196.8	12.76
22.1	1.36737	1.0913	215.9	197.8	12.83
22.2	1.36754	1.0917	217.0	198.8	12.90
22.3	1.36771	1.0922	218.2	199.7	12.97
22.4	1.36787	1.0927	219.3	200.7	13.03
22.5	1.36804	1.0931	220.5	201.7	13.10
22.6	1.36821	1.0936	221.6	202.6	13.17
22.7	1.36838	1.0940	222.8	203.6	13.24
22.8	1.36855	1.0945	223.9	204.6	13.31
22.9	1.36872	1.0950	225.1	205.5	13.38
23.0	1.36889	1.0954	226.2	206.5	13.44
23.1	1.36906	1.0959	227.4	207.5	13.51
23.2	1.36924	1.0964	228.5	208.4	13.58
23.3	1.36941	1.0968	229.7	209.4	13.65
23.4	1.36958	1.0973	230.8	210.4	13.72
23.5	1.36975	1.0977	232.0	211.3	13.79
23.6	1.36992	1.0982	233.2	212.3	13.86
23.7	1.37009	1.0987	234.3	213.3	13.92
23.8	1.37026	1.0991	235.5	214.2	14.00
23.9	1.37043	1.0996	236.6	215.2	14.06
24.0	1.37060	1.1001	237.8	216.2	14.13
24.1	1.37078	1.1005	239.0	217.1	14.20
24.2	1.37095	1.1010	240.1	218.1	14.27
24.3	1.37112	1.1015	241.3	219.1	14.34
24.4	1.37129	1.1019	242.5	220.0	14.41
24.5	1.37146	1.1024	243.6	221.0	14.48
24.6	1.37164	1.1029	244.8	222.0	14.55
24.7	1.37181	1.1033	246.0	222.9	14.62
24.8	1.37198	1.1038	247.1	223.9	14.69
24.9	1.37216	1.1043	248.3	224.8	14.76

COMPENDIUM OF INTERNATIONAL METHODS OF ANALYSIS –OIV
Evaluation of sugar by refractometry

TABLE II - (continued)

Saccharose % (m/m)	Refractive Index at 20°C	Mass Density at 20°C	Sugars In g/l	Sugars In g/Kg	ABV % vol At 20°C
25.0	1.37233	1.1047	249.5	225.8	14.83
25.1	1.37250	1.1052	250.6	226.8	14.89
25.2	1.37267	1.1057	251.8	227.7	14.96
25.3	1.37285	1.1062	253.0	228.7	15.04
25.4	1.37302	1.1066	254.1	229.7	15.10
25.5	1.37319	1.1071	255.3	230.6	15.17
25.6	1.37337	1.1076	256.5	231.6	15.24
25.7	1.37354	1.1080	257.7	232.5	15.32
25.8	1.37372	1.1085	258.8	233.5	15.38
25.9	1.37389	1.1090	260.0	234.5	15.45
26.0	1.37407	1.1095	261.2	235.4	15.52
26.1	1.37424	1.1099	262.4	236.4	15.59
26.2	1.37441	1.1104	263.6	237.3	15.67
26.3	1.37459	1.1109	264.7	238.3	15.73
26.4	1.37476	1.1114	265.9	239.3	15.80
26.5	1.37494	1.1118	267.1	240.2	15.87
26.6	1.37511	1.1123	268.3	241.2	15.95
26.7	1.37529	1.1128	269.5	242.1	16.02
26.8	1.37546	1.1133	270.6	243.1	16.08
26.9	1.37564	1.1138	271.8	244.1	16.15
27.0	1.37582	1.1142	273.0	245.0	16.22
27.1	1.37599	1.1147	274.2	246.0	16.30
27.2	1.37617	1.1152	275.4	246.9	16.37
27.3	1.37634	1.1157	276.6	247.9	16.44
27.4	1.37652	1.1161	277.8	248.9	16.51
27.5	1.37670	1.1166	278.9	249.8	16.58
27.6	1.37687	1.1171	280.1	250.8	16.65
27.7	1.37705	1.1176	281.3	251.7	16.72
27.8	1.37723	1.1181	282.5	252.7	16.79
27.9	1.37740	1.1185	283.7	253.6	16.86
28.0	1.37758	1.1190	284.9	254.6	16.93
28.1	1.37776	1.1195	286.1	255.5	17.00
28.2	1.37793	1.1200	287.3	256.5	17.07
28.3	1.37811	1.1205	288.5	257.5	17.15
28.4	1.37829	1.1210	289.7	258.4	17.22
28.5	1.37847	1.1214	290.9	259.4	17.29
28.6	1.37864	1.1219	292.1	260.3	17.36
28.7	1.37882	1.1224	293.3	261.3	17.43
28.8	1.37900	1.1229	294.5	262.2	17.50
28.9	1.37918	1.1234	295.7	263.2	17.57
29.0	1.37936	1.1239	296.9	264.2	17.64
29.1	1.37954	1.1244	298.1	265.1	17.72
29.2	1.37972	1.1248	299.3	266.1	17.79
29.3	1.37989	1.1253	300.5	267.0	17.86
29.4	1.38007	1.1258	301.7	268.0	17.93
29.5	1.38025	1.1263	302.9	268.9	18.00
29.6	1.38043	1.1268	304.1	269.9	18.07
29.7	1.38061	1.1273	305.3	270.8	18.14
29.8	1.38079	1.1278	306.5	271.8	18.22
29.9	1.38097	1.1283	307.7	272.7	18.29

COMPENDIUM OF INTERNATIONAL METHODS OF ANALYSIS –OIV
Evaluation of sugar by refractometry

TABLE II - (continued)

Saccharose % (m/m)	Refractive Index at 20 °C	Mass Density at 20 °C	Sugars in g/l	Sugars in g/kg	ABV % vol at 20 °C
30.0	1.38115	1.1287	308.9	273.7	18.36
30.1	1.38133	1.1292	310.1	274.6	18.43
30.2	1.38151	1.1297	311.3	275.6	18.50
30.3	1.38169	1.1302	312.6	276.5	18.58
30.4	1.38187	1.1307	313.8	277.5	18.65
30.5	1.38205	1.1312	315.0	278.5	18.72
30.6	1.38223	1.1317	316.2	279.4	18.79
30.7	1.38241	1.1322	317.4	280.4	18.86
30.8	1.38259	1.1327	318.6	281.3	18.93
30.9	1.38277	1.1332	319.8	282.3	19.01
31.0	1.38296	1.1337	321.1	283.2	19.08
31.1	1.38314	1.1342	322.3	284.2	19.15
31.2	1.38332	1.1346	323.5	285.1	19.23
31.3	1.38350	1.1351	324.7	286.1	19.30
31.4	1.38368	1.1356	325.9	287.0	19.37
31.5	1.38386	1.1361	327.2	288.0	19.45
31.6	1.38405	1.1366	328.4	288.9	19.52
31.7	1.38423	1.1371	329.6	289.9	19.59
31.8	1.38441	1.1376	330.8	290.8	19.66
31.9	1.38459	1.1381	332.1	291.8	19.74
32.0	1.38478	1.1386	333.3	292.7	19.81
32.1	1.38496	1.1391	334.5	293.7	19.88
32.2	1.38514	1.1396	335.7	294.6	19.95
32.3	1.38532	1.1401	337.0	295.6	20.03
32.4	1.38551	1.1406	338.2	296.5	20.10
32.5	1.38569	1.1411	339.4	297.5	20.17
32.6	1.38587	1.1416	340.7	298.4	20.25
32.7	1.38606	1.1421	341.9	299.4	20.32
32.8	1.38624	1.1426	343.1	300.3	20.39
32.9	1.38643	1.1431	344.4	301.3	20.47
33.0	1.38661	1.1436	345.6	302.2	20.54
33.1	1.38679	1.1441	346.8	303.2	20.61
33.2	1.38698	1.1446	348.1	304.1	20.69
33.3	1.38716	1.1451	349.3	305.0	20.76
33.4	1.38735	1.1456	350.6	306.0	20.84
33.5	1.38753	1.1461	351.8	306.9	20.91
33.6	1.38772	1.1466	353.0	307.9	20.98
33.7	1.38790	1.1471	354.3	308.8	21.06
33.8	1.38809	1.1476	355.5	309.8	21.13
33.9	1.38827	1.1481	356.8	310.7	21.20
34.0	1.38846	1.1486	358.0	311.7	21.28
34.1	1.38864	1.1491	359.2	312.6	21.35
34.2	1.38883	1.1496	360.5	313.6	21.42
34.3	1.38902	1.1501	361.7	314.5	21.50
34.4	1.38920	1.1507	363.0	315.5	21.57
34.5	1.38939	1.1512	364.2	316.4	21.64
34.6	1.38958	1.1517	365.5	317.4	21.72
34.7	1.38976	1.1522	366.7	318.3	21.79
34.8	1.38995	1.1527	368.0	319.2	21.87
34.9	1.39014	1.1532	369.2	320.2	21.94

COMPENDIUM OF INTERNATIONAL METHODS OF ANALYSIS –OIV
Evaluation of sugar by refractometry

TABLE II - (continued)

Saccharose % (m/m)	Refractive Index at 20 °C	Mass Density at 20 °C	Sugars in g/l	Sugars in g/kg	ABV % vol at 20 °C
35.0	1.39032	1.1537	370.5	321.1	22.02
35.1	1.39051	1.1542	371.8	322.1	22.10
35.2	1.39070	1.1547	373.0	323.0	22.17
35.3	1.39088	1.1552	374.3	324.0	22.24
35.4	1.39107	1.1557	375.5	324.9	22.32
35.5	1.39126	1.1563	376.8	325.9	22.39
35.6	1.39145	1.1568	378.0	326.8	22.46
35.7	1.39164	1.1573	379.3	327.8	22.54
35.8	1.39182	1.1578	380.6	328.7	22.62
35.9	1.39201	1.1583	381.8	329.6	22.69
36.0	1.39220	1.1588	383.1	330.6	22.77
36.1	1.39239	1.1593	384.4	331.5	22.84
36.2	1.39258	1.1598	385.6	332.5	22.92
36.3	1.39277	1.1603	386.9	333.4	22.99
36.4	1.39296	1.1609	388.1	334.4	23.06
36.5	1.39314	1.1614	389.4	335.3	23.14
36.6	1.39333	1.1619	390.7	336.3	23.22
36.7	1.39352	1.1624	392.0	337.2	23.30
36.8	1.39371	1.1629	393.2	338.1	23.37
36.9	1.39390	1.1634	394.5	339.1	23.45
37.0	1.39409	1.1640	395.8	340.0	23.52
37.1	1.39428	1.1645	397.0	341.0	23.59
37.2	1.39447	1.1650	398.3	341.9	23.67
37.3	1.39466	1.1655	399.6	342.9	23.75
37.4	1.39485	1.1660	400.9	343.8	23.83
37.5	1.39504	1.1665	402.1	344.7	23.90
37.6	1.39524	1.1671	403.4	345.7	23.97
37.7	1.39543	1.1676	404.7	346.6	24.05
37.8	1.39562	1.1681	406.0	347.6	24.13
37.9	1.39581	1.1686	407.3	348.5	24.21
38.0	1.39600	1.1691	408.6	349.4	24.28
38.1	1.39619	1.1697	409.8	350.4	24.35
38.2	1.39638	1.1702	411.1	351.3	24.43
38.3	1.39658	1.1707	412.4	352.3	24.51
38.4	1.39677	1.1712	413.7	353.2	24.59
38.5	1.39696	1.1717	415.0	354.2	24.66
38.6	1.39715	1.1723	416.3	355.1	24.74
38.7	1.39734	1.1728	417.6	356.0	24.82
38.8	1.39754	1.1733	418.8	357.0	24.89
38.9	1.39773	1.1738	420.1	357.9	24.97
39.0	1.39792	1.1744	421.4	358.9	25.04
39.1	1.39812	1.1749	422.7	359.8	25.12
39.2	1.39831	1.1754	424.0	360.7	25.20
39.3	1.39850	1.1759	425.3	361.7	25.28
39.4	1.39870	1.1765	426.6	362.6	25.35
39.5	1.39889	1.1770	427.9	363.6	25.43
39.6	1.39908	1.1775	429.2	364.5	25.51
39.7	1.39928	1.1780	430.5	365.4	25.58
39.8	1.39947	1.1786	431.8	366.4	25.66
39.9	1.39967	1.1791	433.1	367.3	25.74

COMPENDIUM OF INTERNATIONAL METHODS OF ANALYSIS –OIV
Evaluation of sugar by refractometry

TABLE II - (continued)

Saccharose % (m/m)	Refractive Index at 20 °C	Mass Density at 20 °C	Sugars in g/l	Sugars in g/kg	ABV % vol at 20 °C
40.0	1.39986	1.1796	434.4	368.3	25.82
40.1	1.40006	1.1801	435.7	369.2	25.89
40.2	1.40025	1.1807	437.0	370.1	25.97
40.3	1.40044	1.1812	438.3	371.1	26.05
40.4	1.40064	1.1817	439.6	372.0	26.13
40.5	1.40083	1.1823	440.9	373.0	26.20
40.6	1.40103	1.1828	442.2	373.9	26.28
40.7	1.40123	1.1833	443.6	374.8	26.36
40.8	1.40142	1.1839	444.9	375.8	26.44
40.9	1.40162	1.1844	446.2	376.7	26.52
41.0	1.40181	1.1849	447.5	377.7	26.59
41.1	1.40201	1.1855	448.8	378.6	26.67
41.2	1.40221	1.1860	450.1	379.5	26.75
41.3	1.40240	1.1865	451.4	380.5	26.83
41.4	1.40260	1.1871	452.8	381.4	26.91
41.5	1.40280	1.1876	454.1	382.3	26.99
41.6	1.40299	1.1881	455.4	383.3	27.06
41.7	1.40319	1.1887	456.7	384.2	27.14
41.8	1.40339	1.1892	458.0	385.2	27.22
41.9	1.40358	1.1897	459.4	386.1	27.30
42.0	1.40378	1.1903	460.7	387.0	27.38
42.1	1.40398	1.1908	462.0	388.0	27.46
42.2	1.40418	1.1913	463.3	388.9	27.53
42.3	1.40437	1.1919	464.7	389.9	27.62
42.4	1.40457	1.1924	466.0	390.8	27.69
42.5	1.40477	1.1929	467.3	391.7	27.77
42.6	1.40497	1.1935	468.6	392.7	27.85
42.7	1.40517	1.1940	470.0	393.6	27.93
42.8	1.40537	1.1946	471.3	394.5	28.01
42.9	1.40557	1.1951	472.6	395.5	28.09
43.0	1.40576	1.1956	474.0	396.4	28.17
43.1	1.40596	1.1962	475.3	397.3	28.25
43.2	1.40616	1.1967	476.6	398.3	28.32
43.3	1.40636	1.1973	478.0	399.2	28.41
43.4	1.40656	1.1978	479.3	400.2	28.48
43.5	1.40676	1.1983	480.7	401.1	28.57
43.6	1.40696	1.1989	482.0	402.0	28.65
43.7	1.40716	1.1994	483.3	403.0	28.72
43.8	1.40736	1.2000	484.7	403.9	28.81
43.9	1.40756	1.2005	486.0	404.8	28.88
44.0	1.40776	1.2011	487.4	405.8	28.97
44.1	1.40796	1.2016	488.7	406.7	29.04
44.2	1.40817	1.2022	490.1	407.6	29.13
44.3	1.40837	1.2027	491.4	408.6	29.20
44.4	1.40857	1.2032	492.8	409.5	29.29
44.5	1.40877	1.2038	494.1	410.4	29.36
44.6	1.40897	1.2043	495.5	411.4	29.45
44.7	1.40917	1.2049	496.8	412.3	29.52
44.8	1.40937	1.2054	498.2	413.3	29.61
44.9	1.40958	1.2060	499.5	414.2	29.69

COMPENDIUM OF INTERNATIONAL METHODS OF ANALYSIS –OIV
Evaluation of sugar by refractometry

TABLE II - (continued)

Saccharose % (m/m)	Refractive Index at 20 °C	Mass Density at 20 °C	Sugars in g/l	Sugars in g/kg	ABV % vol at 20 °C
45.0	1.40978	1.2065	500.9	415.1	29.77
45.1	1.40998	1.2071	502.2	416.1	29.85
45.2	1.41018	1.2076	503.6	417.0	29.93
45.3	1.41039	1.2082	504.9	417.9	30.01
45.4	1.41059	1.2087	506.3	418.9	30.09
45.5	1.41079	1.2093	507.7	419.8	30.17
45.6	1.41099	1.2098	509.0	420.7	30.25
45.7	1.41120	1.2104	510.4	421.7	30.33
45.8	1.41140	1.2109	511.7	422.6	30.41
45.9	1.41160	1.2115	513.1	423.5	30.49
46.0	1.41181	1.2120	514.5	424.5	30.58
46.1	1.41201	1.2126	515.8	425.4	30.65
46.2	1.41222	1.2131	517.2	426.3	30.74
46.3	1.41242	1.2137	518.6	427.3	30.82
46.4	1.41262	1.2142	519.9	428.2	30.90
46.5	1.41283	1.2148	521.3	429.1	30.98
46.6	1.41303	1.2154	522.7	430.1	31.06
46.7	1.41324	1.2159	524.1	431.0	31.15
46.8	1.41344	1.2165	525.4	431.9	31.22
46.9	1.41365	1.2170	526.8	432.9	31.31
47.0	1.41385	1.2176	528.2	433.8	31.39
47.1	1.41406	1.2181	529.6	434.7	31.47
47.2	1.41427	1.2187	530.9	435.7	31.55
47.3	1.41447	1.2192	532.3	436.6	31.63
47.4	1.41468	1.2198	533.7	437.5	31.72
47.5	1.41488	1.2204	535.1	438.5	31.80
47.6	1.41509	1.2209	536.5	439.4	31.88
47.7	1.41530	1.2215	537.9	440.3	31.97
47.8	1.41550	1.2220	539.2	441.3	32.04
47.9	1.41571	1.2226	540.6	442.2	32.13
48.0	1.41592	1.2232	542.0	443.1	32.21
48.1	1.41612	1.2237	543.4	444.1	32.29
48.2	1.41633	1.2243	544.8	445.0	32.38
48.3	1.41654	1.2248	546.2	445.9	32.46
48.4	1.41674	1.2254	547.6	446.8	32.54
48.5	1.41695	1.2260	549.0	447.8	32.63
48.6	1.41716	1.2265	550.4	448.7	32.71
48.7	1.41737	1.2271	551.8	449.6	32.79
48.8	1.41758	1.2277	553.2	450.6	32.88
48.9	1.41779	1.2282	554.6	451.5	32.96
49.0	1.41799	1.2288	556.0	452.4	33.04
49.1	1.41820	1.2294	557.4	453.4	33.13
49.2	1.41841	1.2299	558.8	454.3	33.21
49.3	1.41862	1.2305	560.2	455.2	33.29
49.4	1.41883	1.2311	561.6	456.2	33.38
49.5	1.41904	1.2316	563.0	457.1	33.46
49.6	1.41925	1.2322	564.4	458.0	33.54
49.7	1.41946	1.2328	565.8	458.9	33.63
49.8	1.41967	1.2333	567.2	459.9	33.71
49.9	1.41988	1.2339	568.6	460.8	33.79

COMPENDIUM OF INTERNATIONAL METHODS OF ANALYSIS –OIV
Evaluation of sugar by refractometry

TABLE II - (continued)

Saccharose % (m/m)	Refractive Index at 20 °C	Mass Density at 20 °C	Sugars in g/l	Sugars in g/kg	ABV % vol at 20 °C
50.0	1.42009	1.2345	570.0	461.7	33.88
50.1	1.42030	1.2350	571.4	462.7	33.96
50.2	1.42051	1.2356	572.8	463.6	34.04
50.3	1.42072	1.2362	574.2	464.5	34.12
50.4	1.42093	1.2368	575.6	465.4	34.21
50.5	1.42114	1.2373	577.1	466.4	34.30
50.6	1.42135	1.2379	578.5	467.3	34.38
50.7	1.42156	1.2385	579.9	468.2	34.46
50.8	1.42177	1.2390	581.3	469.2	34.55
50.9	1.42199	1.2396	582.7	470.1	34.63
51.0	1.42220	1.2402	584.2	471.0	34.72
51.1	1.42241	1.2408	585.6	471.9	34.80
51.2	1.42262	1.2413	587.0	472.9	34.89
51.3	1.42283	1.2419	588.4	473.8	34.97
51.4	1.42305	1.2425	589.9	474.7	35.06
51.5	1.42326	1.2431	591.3	475.7	35.14
51.6	1.42347	1.2436	592.7	476.6	35.22
51.7	1.42368	1.2442	594.1	477.5	35.31
51.8	1.42390	1.2448	595.6	478.4	35.40
51.9	1.42411	1.2454	597.0	479.4	35.48
52.0	1.42432	1.2460	598.4	480.3	35.56
52.1	1.42454	1.2465	599.9	481.2	35.65
52.2	1.42475	1.2471	601.3	482.1	35.74
52.3	1.42496	1.2477	602.7	483.1	35.82
52.4	1.42518	1.2483	604.2	484.0	35.91
52.5	1.42539	1.2488	605.6	484.9	35.99
52.6	1.42561	1.2494	607.0	485.8	36.07
52.7	1.42582	1.2500	608.5	486.8	36.16
52.8	1.42604	1.2506	609.9	487.7	36.25
52.9	1.42625	1.2512	611.4	488.6	36.34
53.0	1.42647	1.2518	612.8	489.5	36.42
53.1	1.42668	1.2523	614.2	490.5	36.50
53.2	1.42690	1.2529	615.7	491.4	36.59
53.3	1.42711	1.2535	617.1	492.3	36.67
53.4	1.42733	1.2541	618.6	493.2	36.76
53.5	1.42754	1.2547	620.0	494.2	36.85
53.6	1.42776	1.2553	621.5	495.1	36.94
53.7	1.42798	1.2558	622.9	496.0	37.02
53.8	1.42819	1.2564	624.4	496.9	37.11
53.9	1.42841	1.2570	625.8	497.9	37.19
54.0	1.42863	1.2576	627.3	498.8	37.28
54.1	1.42884	1.2582	628.7	499.7	37.36
54.2	1.42906	1.2588	630.2	500.6	37.45
54.3	1.42928	1.2594	631.7	501.6	37.54
54.4	1.42949	1.2600	633.1	502.5	37.63
54.5	1.42971	1.2606	634.6	503.4	37.71
54.6	1.42993	1.2611	636.0	504.3	37.80
54.7	1.43015	1.2617	637.5	505.2	37.89
54.8	1.43036	1.2623	639.0	506.2	37.98
54.9	1.43058	1.2629	640.4	507.1	38.06

COMPENDIUM OF INTERNATIONAL METHODS OF ANALYSIS –OIV
Evaluation of sugar by refractometry

TABLE II - (continued)

Saccharose % (m/m)	Refractive Index at 20 °C	Mass Density at 20 °C	Sugars in g/l	Sugars in g/kg	ABV % vol at 20 °C
55.0	1.43080	1.2635	641.9	508.0	38.15
55.1	1.43102	1.2641	643.4	508.9	38.24
55.2	1.43124	1.2647	644.8	509.9	38.32
55.3	1.43146	1.2653	646.3	510.8	38.41
55.4	1.43168	1.2659	647.8	511.7	38.50
55.5	1.43189	1.2665	649.2	512.6	38.58
55.6	1.43211	1.2671	650.7	513.5	38.67
55.7	1.43233	1.2677	652.2	514.5	38.76
55.8	1.43255	1.2683	653.7	515.4	38.85
55.9	1.43277	1.2689	655.1	516.3	38.93
56.0	1.43299	1.2695	656.6	517.2	39.02
56.1	1.43321	1.2701	658.1	518.1	39.11
56.2	1.43343	1.2706	659.6	519.1	39.20
56.3	1.43365	1.2712	661.0	520.0	39.28
56.4	1.43387	1.2718	662.5	520.9	39.37
56.5	1.43410	1.2724	664.0	521.8	39.46
56.6	1.43432	1.2730	665.5	522.7	39.55
56.7	1.43454	1.2736	667.0	523.7	39.64
56.8	1.43476	1.2742	668.5	524.6	39.73
56.9	1.43498	1.2748	669.9	525.5	39.81
57.0	1.43520	1.2754	671.4	526.4	39.90
57.1	1.43542	1.2760	672.9	527.3	39.99
57.2	1.43565	1.2766	674.4	528.3	40.08
57.3	1.43587	1.2773	675.9	529.2	40.17
57.4	1.43609	1.2779	677.4	530.1	40.26
57.5	1.43631	1.2785	678.9	531.0	40.35
57.6	1.43653	1.2791	680.4	531.9	40.44
57.7	1.43676	1.2797	681.9	532.8	40.53
57.8	1.43698	1.2803	683.4	533.8	40.61
57.9	1.43720	1.2809	684.9	534.7	40.70
58.0	1.43743	1.2815	686.4	535.6	40.79
58.1	1.43765	1.2821	687.9	536.5	40.88
58.2	1.43787	1.2827	689.4	537.4	40.97
58.3	1.43810	1.2833	690.9	538.3	41.06
58.4	1.43832	1.2839	692.4	539.3	41.15
58.5	1.43855	1.2845	693.9	540.2	41.24
58.6	1.43877	1.2851	695.4	541.1	41.33
58.7	1.43899	1.2857	696.9	542.0	41.42
58.8	1.43922	1.2863	698.4	542.9	41.51
58.9	1.43944	1.2870	699.9	543.8	41.60
59.0	1.43967	1.2876	701.4	544.8	41.68
59.1	1.43989	1.2882	702.9	545.7	41.77
59.2	1.44012	1.2888	704.4	546.6	41.86
59.3	1.44035	1.2894	706.0	547.5	41.96
59.4	1.44057	1.2900	707.5	548.4	42.05
59.5	1.44080	1.2906	709.0	549.3	42.14
59.6	1.44102	1.2912	710.5	550.2	42.23
59.7	1.44125	1.2919	712.0	551.1	42.31
59.8	1.44148	1.2925	713.5	552.1	42.40
59.9	1.44170	1.2931	715.1	553.0	42.50

COMPENDIUM OF INTERNATIONAL METHODS OF ANALYSIS –OIV
Evaluation of sugar by refractometry

TABLE II - (continued)

Saccharose % (m/m)	Refractive Index at 20 °C	Mass Density at 20 °C	Sugars in g/l	Sugars in g/kg	ABV % vol at 20 °C
60.0	1.44193	1.2937	716.6	553.9	42.59
60.1	1.44216	1.2943	718.1	554.8	42.68
60.2	1.44238	1.2949	719.6	555.7	42.77
60.3	1.44261	1.2956	721.1	556.6	42.85
60.4	1.44284	1.2962	722.7	557.5	42.95
60.5	1.44306	1.2968	724.2	558.4	43.04
60.6	1.44329	1.2974	725.7	559.4	43.13
60.7	1.44352	1.2980	727.3	560.3	43.22
60.8	1.44375	1.2986	728.8	561.2	43.31
60.9	1.44398	1.2993	730.3	562.1	43.40
61.0	1.44420	1.2999	731.8	563.0	43.49
61.1	1.44443	1.3005	733.4	563.9	43.59
61.2	1.44466	1.3011	734.9	564.8	43.68
61.3	1.44489	1.3017	736.4	565.7	43.76
61.4	1.44512	1.3024	738.0	566.6	43.86
61.5	1.44535	1.3030	739.5	567.6	43.95
61.6	1.44558	1.3036	741.1	568.5	44.04
61.7	1.44581	1.3042	742.6	569.4	44.13
61.8	1.44604	1.3049	744.1	570.3	44.22
61.9	1.44627	1.3055	745.7	571.2	44.32
62.0	1.44650	1.3061	747.2	572.1	44.41
62.1	1.44673	1.3067	748.8	573.0	44.50
62.2	1.44696	1.3074	750.3	573.9	44.59
62.3	1.44719	1.3080	751.9	574.8	44.69
62.4	1.44742	1.3086	753.4	575.7	44.77
62.5	1.44765	1.3092	755.0	576.6	44.87
62.6	1.44788	1.3099	756.5	577.5	44.96
62.7	1.44811	1.3105	758.1	578.5	45.05
62.8	1.44834	1.3111	759.6	579.4	45.14
62.9	1.44858	1.3118	761.2	580.3	45.24
63.0	1.44881	1.3124	762.7	581.2	45.33
63.1	1.44904	1.3130	764.3	582.1	45.42
63.2	1.44927	1.3137	765.8	583.0	45.51
63.3	1.44950	1.3143	767.4	583.9	45.61
63.4	1.44974	1.3149	769.0	584.8	45.70
63.5	1.44997	1.3155	770.5	585.7	45.79
63.6	1.45020	1.3162	772.1	586.6	45.89
63.7	1.45043	1.3168	773.6	587.5	45.98
63.8	1.45067	1.3174	775.2	588.4	46.07
63.9	1.45090	1.3181	776.8	589.3	46.17
64.0	1.45113	1.3187	778.3	590.2	46.25
64.1	1.45137	1.3193	779.9	591.1	46.35
64.2	1.45160	1.3200	781.5	592.0	46.44
64.3	1.45184	1.3206	783.0	592.9	46.53
64.4	1.45207	1.3213	784.6	593.8	46.63
64.5	1.45230	1.3219	786.2	594.7	46.72
64.6	1.45254	1.3225	787.8	595.6	46.82
64.7	1.45277	1.3232	789.3	596.5	46.91
64.8	1.45301	1.3238	790.9	597.4	47.00
64.9	1.45324	1.3244	792.5	598.3	47.10

COMPENDIUM OF INTERNATIONAL METHODS OF ANALYSIS –OIV
Evaluation of sugar by refractometry

TABLE II - (continued)

Saccharose % (m/m)	Refractive Index at 20 °C	Mass Density at 20 °C	Sugars in g/l	Sugars in g/kg	ABV % vol at 20 °C
65.0	1.45348	1.3251	794.1	599.3	47.19
65.1	1.45371	1.3257	795.6	600.2	47.28
65.2	1.45395	1.3264	797.2	601.1	47.38
65.3	1.45418	1.3270	798.8	602.0	47.47
65.4	1.45442	1.3276	800.4	602.9	47.57
65.5	1.45466	1.3283	802.0	603.8	47.66
65.6	1.45489	1.3289	803.6	604.7	47.76
65.7	1.45513	1.3296	805.1	605.6	47.85
65.8	1.45537	1.3302	806.7	606.5	47.94
65.9	1.45560	1.3309	808.3	607.4	48.04
66.0	1.45584	1.3315	809.9	608.3	48.13
66.1	1.45608	1.3322	811.5	609.2	48.23
66.2	1.45631	1.3328	813.1	610.1	48.32
66.3	1.45655	1.3334	814.7	611.0	48.42
66.4	1.45679	1.3341	816.3	611.9	48.51
66.5	1.45703	1.3347	817.9	612.8	48.61
66.6	1.45726	1.3354	819.5	613.7	48.70
66.7	1.45750	1.3360	821.1	614.6	48.80
66.8	1.45774	1.3367	822.7	615.5	48.89
66.9	1.45798	1.3373	824.3	616.3	48.99
67.0	1.45822	1.3380	825.9	617.2	49.08
67.1	1.45846	1.3386	827.5	618.1	49.18
67.2	1.45870	1.3393	829.1	619.0	49.27
67.3	1.45893	1.3399	830.7	619.9	49.37
67.4	1.45917	1.3406	832.3	620.8	49.46
67.5	1.45941	1.3412	833.9	621.7	49.56
67.6	1.45965	1.3419	835.5	622.6	49.65
67.7	1.45989	1.3425	837.1	623.5	49.75
67.8	1.46013	1.3432	838.7	624.4	49.84
67.9	1.46037	1.3438	840.3	625.3	49.94
68.0	1.46061	1.3445	841.9	626.2	50.03
68.1	1.46085	1.3451	843.6	627.1	50.14
68.2	1.46109	1.3458	845.2	628.0	50.23
68.3	1.46134	1.3464	846.8	628.9	50.33
68.4	1.46158	1.3471	848.4	629.8	50.42
68.5	1.46182	1.3478	850.0	630.7	50.52
68.6	1.46206	1.3484	851.6	631.6	50.61
68.7	1.46230	1.3491	853.3	632.5	50.71
68.8	1.46254	1.3497	854.9	633.4	50.81
68.9	1.46278	1.3504	856.5	634.3	50.90
69.0	1.46303	1.3510	858.1	635.2	51.00
69.1	1.46327	1.3517	859.8	636.1	51.10
69.2	1.46351	1.3524	861.4	636.9	51.19
69.3	1.46375	1.3530	863.0	637.8	51.29
69.4	1.46400	1.3537	864.7	638.7	51.39
69.5	1.46424	1.3543	866.3	639.6	51.48
69.6	1.46448	1.3550	867.9	640.5	51.58
69.7	1.46473	1.3557	869.5	641.4	51.67
69.8	1.46497	1.3563	871.2	642.3	51.78
69.9	1.46521	1.3570	872.8	643.2	51.87

COMPENDIUM OF INTERNATIONAL METHODS OF ANALYSIS –OIV
Evaluation of sugar by refractometry

TABLE II - (continued)

Saccharose % (m/m)	Refractive Index at 20 °C	Mass Density at 20 °C	Sugars in g/l	Sugars in g/kg	ABV % vol at 20 °C
70.0	1.46546	1.3576	874.5	644.1	51.97
70.1	1.46570	1.3583	876.1	645.0	52.07
70.2	1.46594	1.3590	877.7	645.9	52.16
70.3	1.46619	1.3596	879.4	646.8	52.26
70.4	1.46643	1.3603	881.0	647.7	52.36
70.5	1.46668	1.3610	882.7	648.5	52.46
70.6	1.46692	1.3616	884.3	649.4	52.55
70.7	1.46717	1.3623	886.0	650.3	52.65
70.8	1.46741	1.3630	887.6	651.2	52.75
70.9	1.46766	1.3636	889.3	652.1	52.85
71.0	1.46790	1.3643	890.9	653.0	52.95
71.1	1.46815	1.3650	892.6	653.9	53.05
71.2	1.46840	1.3656	894.2	654.8	53.14
71.3	1.46864	1.3663	895.9	655.7	53.24
71.4	1.46889	1.3670	897.5	656.6	53.34
71.5	1.46913	1.3676	899.2	657.5	53.44
71.6	1.46938	1.3683	900.8	658.3	53.53
71.7	1.46963	1.3690	902.5	659.2	53.64
71.8	1.46987	1.3696	904.1	660.1	53.73
71.9	1.47012	1.3703	905.8	661.0	53.83
72.0	1.47037	1.3710	907.5	661.9	53.93
72.1	1.47062	1.3717	909.1	662.8	54.03
72.2	1.47086	1.3723	910.8	663.7	54.13
72.3	1.47111	1.3730	912.5	664.6	54.23
72.4	1.47136	1.3737	914.1	665.5	54.32
72.5	1.47161	1.3743	915.8	666.3	54.43
72.6	1.47186	1.3750	917.5	667.2	54.53
72.7	1.47210	1.3757	919.1	668.1	54.62
72.8	1.47235	1.3764	920.8	669.0	54.72
72.9	1.47260	1.3770	922.5	669.9	54.82
73.0	1.47285	1.3777	924.2	670.8	54.93
73.1	1.47310	1.3784	925.8	671.7	55.02
73.2	1.47335	1.3791	927.5	672.6	55.12
73.3	1.47360	1.3797	929.2	673.5	55.22
73.4	1.47385	1.3804	930.9	674.3	55.32
73.5	1.47410	1.3811	932.6	675.2	55.42
73.6	1.47435	1.3818	934.3	676.1	55.53
73.7	1.47460	1.3825	935.9	677.0	55.62
73.8	1.47485	1.3831	937.6	677.9	55.72
73.9	1.47510	1.3838	939.3	678.8	55.82
74.0	1.47535	1.3845	941.0	679.7	55.92
74.1	1.47560	1.3852	942.7	680.6	56.02
74.2	1.47585	1.3859	944.4	681.4	56.13
74.3	1.47610	1.3865	946.1	682.3	56.23
74.4	1.47635	1.3872	947.8	683.2	56.33
74.5	1.47661	1.3879	949.5	684.1	56.43
74.6	1.47686	1.3886	951.2	685.0	56.53
74.7	1.47711	1.3893	952.9	685.9	56.63
74.8	1.47736	1.3899	954.6	686.8	56.73
74.9	1.47761	1.3906	956.3	687.7	56.83

TABLE III

Table giving the sugar concentration in rectified concentrated must
in grams per liter and grams per kilogram.
determined by means of a refractometer graduated
either in percentage by mass of sucrose at 20°C
or in refractive index at 20°C.

COMPENDIUM OF INTERNATIONAL METHODS OF ANALYSIS –OIV
Evaluation of sugar by refractometry

TABLE III

Saccharose % (m/m)	Refractive Index at 20 °C	Mass Density at 20 °C	Sugars in g/l	Sugars in g/kg	ABV % vol at 20 °C
50.0	1.42008	1.2342	627.6	508.5	37.30
50.1	1.42029	1.2348	629.3	509.6	37.40
50.2	1.42050	1.2355	630.9	510.6	37.49
50.3	1.42071	1.2362	632.4	511.6	37.58
50.4	1.42092	1.2367	634.1	512.7	37.68
50.5	1.42113	1.2374	635.7	513.7	37.78
50.6	1.42135	1.2381	637.3	514.7	37.87
50.7	1.42156	1.2386	638.7	515.7	37.96
50.8	1.42177	1.2391	640.4	516.8	38.06
50.9	1.42198	1.2396	641.9	517.8	38.15
51.0	1.42219	1.2401	643.4	518.8	38.24
51.1	1.42240	1.2406	645.0	519.9	38.33
51.2	1.42261	1.2411	646.5	520.9	38.42
51.3	1.42282	1.2416	648.1	522.0	38.52
51.4	1.42304	1.2421	649.6	523.0	38.61
51.5	1.42325	1.2427	651.2	524.0	38.70
51.6	1.42347	1.2434	652.9	525.1	38.80
51.7	1.42368	1.2441	654.5	526.1	38.90
51.8	1.42389	1.2447	656.1	527.1	38.99
51.9	1.42410	1.2454	657.8	528.2	39.09
52.0	1.42432	1.2461	659.4	529.2	39.19
52.1	1.42453	1.2466	661.0	530.2	39.28
52.2	1.42475	1.2470	662.5	531.3	39.37
52.3	1.42496	1.2475	664.1	532.3	39.47
52.4	1.42517	1.2480	665.6	533.3	39.56
52.5	1.42538	1.2486	667.2	534.4	39.65
52.6	1.42560	1.2493	668.9	535.4	39.75
52.7	1.42581	1.2500	670.5	536.4	39.85
52.8	1.42603	1.2506	672.2	537.5	39.95
52.9	1.42624	1.2513	673.8	538.5	40.04
53.0	1.42645	1.2520	675.5	539.5	40.14
53.1	1.42667	1.2525	677.1	540.6	40.24
53.2	1.42689	1.2530	678.5	541.5	40.32
53.3	1.42711	1.2535	680.2	542.6	40.42
53.4	1.42733	1.2540	681.8	543.7	40.52
53.5	1.42754	1.2546	683.4	544.7	40.61
53.6	1.42776	1.2553	685.1	545.8	40.72
53.7	1.42797	1.2560	686.7	546.7	40.81
53.8	1.42819	1.2566	688.4	547.8	40.91
53.9	1.42840	1.2573	690.1	548.9	41.01
54.0	1.42861	1.2580	691.7	549.8	41.11
54.1	1.42884	1.2585	693.3	550.9	41.20
54.2	1.42906	1.2590	694.9	551.9	41.30
54.3	1.42927	1.2595	696.5	553.0	41.39
54.4	1.42949	1.2600	698.1	554.0	41.49
54.5	1.42971	1.2606	699.7	555.1	41.58
54.6	1.42993	1.2613	701.4	556.1	41.68
54.7	1.43014	1.2620	703.1	557.1	41.79
54.8	1.43036	1.2625	704.7	558.2	41.88
54.9	1.43058	1.2630	706.2	559.1	41.97

COMPENDIUM OF INTERNATIONAL METHODS OF ANALYSIS –OIV
Evaluation of sugar by refractometry

TABLE III – (continued)

Saccharose % (m/m)	Refractive Index at 20 °C	Mass Density at 20 °C	Sugars in g/l	Sugars in g/kg	ABV % vol at 20 °C
55.0	1.43079	1.2635	707.8	560.2	42.06
55.1	1.43102	1.2639	709.4	561.3	42.16
55.2	1.43124	1.2645	711.0	562.3	42.25
55.3	1.43146	1.2652	712.7	563.3	42.36
55.4	1.43168	1.2659	714.4	564.3	42.46
55.5	1.43189	1.2665	716.1	565.4	42.56
55.6	1.43211	1.2672	717.8	566.4	42.66
55.7	1.43233	1.2679	719.5	567.5	42.76
55.8	1.43255	1.2685	721.1	568.5	42.85
55.9	1.43277	1.2692	722.8	569.5	42.96
56.0	1.43298	1.2699	724.5	570.5	43.06
56.1	1.43321	1.2703	726.1	571.6	43.15
56.2	1.43343	1.2708	727.7	572.6	43.25
56.3	1.43365	1.2713	729.3	573.7	43.34
56.4	1.43387	1.2718	730.9	574.7	43.44
56.5	1.43409	1.2724	732.6	575.8	43.54
56.6	1.43431	1.2731	734.3	576.8	43.64
56.7	1.43454	1.2738	736.0	577.8	43.74
56.8	1.43476	1.2744	737.6	578.8	43.84
56.9	1.43498	1.2751	739.4	579.9	43.94
57.0	1.43519	1.2758	741.1	580.9	44.04
57.1	1.43542	1.2763	742.8	582.0	44.14
57.2	1.43564	1.2768	744.4	583.0	44.24
57.3	1.43586	1.2773	745.9	584.0	44.33
57.4	1.43609	1.2778	747.6	585.1	44.43
57.5	1.43631	1.2784	749.3	586.1	44.53
57.6	1.43653	1.2791	751.0	587.1	44.63
57.7	1.43675	1.2798	752.7	588.1	44.73
57.8	1.43698	1.2804	754.4	589.2	44.83
57.9	1.43720	1.2810	756.1	590.2	44.94
58.0	1.43741	1.2818	757.8	591.2	45.04
58.1	1.43764	1.2822	759.5	592.3	45.14
58.2	1.43784	1.2827	761.1	593.4	45.23
58.3	1.43909	1.2832	762.6	594.3	45.32
58.4	1.43832	1.2837	764.3	595.4	45.42
58.5	1.43854	1.2843	766.0	596.4	45.52
58.6	1.43877	1.2850	767.8	597.5	45.63
58.7	1.43899	1.2857	769.5	598.5	45.73
58.8	1.43922	1.2863	771.1	599.5	45.83
58.9	1.43944	1.2869	772.9	600.6	45.93
59.0	1.43966	1.2876	774.6	601.6	46.03
59.1	1.43988	1.2882	776.3	602.6	46.14
59.2	1.44011	1.2889	778.1	603.7	46.24
59.3	1.44034	1.2896	779.8	604.7	46.34
59.4	1.44057	1.2902	781.6	605.8	46.45
59.5	1.44079	1.2909	783.3	606.8	46.55
59.6	1.44102	1.2916	785.2	607.9	46.66
59.7	1.44124	1.2921	786.8	608.9	46.76
59.8	1.44147	1.2926	788.4	609.9	46.85
59.9	1.44169	1.2931	790.0	610.9	46.95

COMPENDIUM OF INTERNATIONAL METHODS OF ANALYSIS –OIV
Evaluation of sugar by refractometry

TABLE III - (continued)

Saccharose % (m/m)	Refractive Index at 20 °C	Mass Density at 20 °C	Sugars in g/l	Sugars in g/kg	ABV % vol at 20 °C
60.0	1.44192	1.2936	791.7	612.0	47.05
60.1	1.44215	1.2942	793.3	613.0	47.15
60.2	1.44238	1.2949	795.2	614.1	47.26
60.3	1.44260	1.2956	796.9	615.1	47.36
60.4	1.44283	1.2962	798.6	616.1	47.46
60.5	1.44305	1.2969	800.5	617.2	47.57
60.6	1.44328	1.2976	802.2	618.2	47.67
60.7	1.44351	1.2981	803.9	619.3	47.78
60.8	1.44374	1.2986	805.5	620.3	47.87
60.9	1.44397	1.2991	807.1	621.3	47.97
61.0	1.44419	1.2996	808.7	622.3	48.06
61.1	1.44442	1.3002	810.5	623.4	48.17
61.2	1.44465	1.3009	812.3	624.4	48.27
61.3	1.44488	1.3016	814.2	625.5	48.39
61.4	1.44511	1.3022	815.8	626.5	48.48
61.5	1.44534	1.3029	817.7	627.6	48.60
61.6	1.44557	1.3036	819.4	628.6	48.70
61.7	1.44580	1.3042	821.3	629.7	48.81
61.8	1.44603	1.3049	823.0	630.7	48.91
61.9	1.44626	1.3056	824.8	631.7	49.02
62.0	1.44648	1.3062	826.6	632.8	49.12
62.1	1.44672	1.3068	828.3	633.8	49.23
62.2	1.44695	1.3075	830.0	634.8	49.33
62.3	1.44718	1.3080	831.8	635.9	49.43
62.4	1.44741	1.3085	833.4	636.9	49.53
62.5	1.44764	1.3090	835.1	638.0	49.63
62.6	1.44787	1.3095	836.8	639.0	49.73
62.7	1.44810	1.3101	838.5	640.0	49.83
62.8	1.44833	1.3108	840.2	641.0	49.93
62.9	1.44856	1.3115	842.1	642.1	50.05
63.0	1.44879	1.3121	843.8	643.1	50.15
63.1	1.44902	1.3128	845.7	644.2	50.26
63.2	1.44926	1.3135	847.5	645.2	50.37
63.3	1.44949	1.3141	849.3	646.3	50.47
63.4	1.44972	1.3148	851.1	647.3	50.58
63.5	1.44995	1.3155	853.0	648.4	50.69
63.6	1.45019	1.3161	854.7	649.4	50.79
63.7	1.45042	1.3168	856.5	650.4	50.90
63.8	1.45065	1.3175	858.4	651.5	51.01
63.9	1.45088	1.3180	860.0	652.5	51.11
64.0	1.45112	1.3185	861.6	653.5	51.20
64.1	1.45135	1.3190	863.4	654.6	51.31
64.2	1.45158	1.3195	865.1	655.6	51.41
64.3	1.45181	1.3201	866.9	656.7	51.52
64.4	1.45205	1.3208	868.7	657.7	51.63
64.5	1.45228	1.3215	870.6	658.8	51.74
64.6	1.45252	1.3221	872.3	659.8	51.84
64.7	1.45275	1.3228	874.1	660.8	51.95
64.8	1.45299	1.3235	876.0	661.9	52.06
64.9	1.45322	1.3241	877.8	662.9	52.17

COMPENDIUM OF INTERNATIONAL METHODS OF ANALYSIS –OIV
Evaluation of sugar by refractometry

TABLE III - (continued)

Saccharose % (m/m)	Refractive Index at 20 °C	Mass Density at 20 °C	Sugars in g/l	Sugars in g/kg	ABV % vol at 20 °C
65.0	1.45347	1.3248	879.7	664.0	52.28
65.1	1.45369	1.3255	881.5	665.0	52.39
65.2	1.45393	1.3261	883.2	666.0	52.49
65.3	1.45416	1.3268	885.0	667.0	52.60
65.4	1.45440	1.3275	886.9	668.1	52.71
65.5	1.45463	1.3281	888.8	669.2	52.82
65.6	1.45487	1.3288	890.6	670.2	52.93
65.7	1.45510	1.3295	892.4	671.2	53.04
65.8	1.45534	1.3301	894.2	672.3	53.14
65.9	1.45557	1.3308	896.0	673.3	53.25
66.0	1.45583	1.3315	898.0	674.4	53.37
66.1	1.45605	1.3320	899.6	675.4	53.46
66.2	1.45629	1.3325	901.3	676.4	53.56
66.3	1.45652	1.3330	903.1	677.5	53.67
66.4	1.45676	1.3335	904.8	678.5	53.77
66.5	1.45700	1.3341	906.7	679.6	53.89
66.6	1.45724	1.3348	908.5	680.6	53.99
66.7	1.45747	1.3355	910.4	681.7	54.11
66.8	1.45771	1.3361	912.2	682.7	54.21
66.9	1.45795	1.3367	913.9	683.7	54.31
67.0	1.45820	1.3374	915.9	684.8	54.43
67.1	1.45843	1.3380	917.6	685.8	54.53
67.2	1.45867	1.3387	919.6	686.9	54.65
67.3	1.45890	1.3395	921.4	687.9	54.76
67.4	1.45914	1.3400	923.1	688.9	54.86
67.5	1.45938	1.3407	925.1	690.0	54.98
67.6	1.45962	1.3415	927.0	691.0	55.09
67.7	1.45986	1.3420	928.8	692.1	55.20
67.8	1.46010	1.3427	930.6	693.1	55.31
67.9	1.46034	1.3434	932.6	694.2	55.42
68.0	1.46060	1.3440	934.4	695.2	55.53
68.1	1.46082	1.3447	936.2	696.2	55.64
68.2	1.46106	1.3454	938.0	697.2	55.75
68.3	1.46130	1.3460	939.9	698.3	55.86
68.4	1.46154	1.3466	941.8	699.4	55.97
68.5	1.46178	1.3473	943.7	700.4	56.08
68.6	1.46202	1.3479	945.4	701.4	56.19
68.7	1.46226	1.3486	947.4	702.5	56.30
68.8	1.46251	1.3493	949.2	703.5	56.41
68.9	1.46275	1.3499	951.1	704.6	56.52
69.0	1.46301	1.3506	953.0	705.6	56.64
69.1	1.46323	1.3513	954.8	706.6	56.74
69.2	1.46347	1.3519	956.7	707.7	56.86
69.3	1.46371	1.3526	958.6	708.7	56.97
69.4	1.46396	1.3533	960.6	709.8	57.09
69.5	1.46420	1.3539	962.4	710.8	57.20
69.6	1.46444	1.3546	964.3	711.9	57.31
69.7	1.46468	1.3553	966.2	712.9	57.42
69.8	1.46493	1.3560	968.2	714.0	57.54
69.9	1.46517	1.3566	970.0	715.0	57.65

COMPENDIUM OF INTERNATIONAL METHODS OF ANALYSIS –OIV
Evaluation of sugar by refractometry

TABLE III - (continued)

Saccharose % (m/m)	Refractive Index at 20 °C	Mass Density à 20 °C	Sugars in g/l	Sugars in g/kg	ABV % vol at 20 °C
70.0	1.46544	1.3573	971.8	716.0	57.75
70.1	1.46565	1.3579	973.8	717.1	57.87
70.2	1.46590	1.3586	975.6	718.1	57.98
70.3	1.46614	1.3593	977.6	719.2	58.10
70.4	1.46639	1.3599	979.4	720.2	58.21
70.5	1.46663	1.3606	981.3	721.2	58.32
70.6	1.46688	1.3613	983.3	722.3	58.44
70.7	1.46712	1.3619	985.2	723.4	58.55
70.8	1.46737	1.3626	987.1	724.4	58.66
70.9	1.46761	1.3633	988.9	725.4	58.77
71.0	1.46789	1.3639	990.9	726.5	58.89
71.1	1.46810	1.3646	992.8	727.5	59.00
71.2	1.46835	1.3653	994.8	728.6	59.12
71.3	1.46859	1.3659	996.6	729.6	59.23
71.4	1.46884	1.3665	998.5	730.7	59.34
71.5	1.46908	1.3672	1000.4	731.7	59.45
71.6	1.46933	1.3678	1002.2	732.7	59.56
71.7	1.46957	1.3685	1004.2	733.8	59.68
71.8	1.46982	1.3692	1006.1	734.8	59.79
71.9	1.47007	1.3698	1008.0	735.9	59.91
72.0	1.47036	1.3705	1009.9	736.9	60.02
72.1	1.47056	1.3712	1012.0	738.0	60.14
72.2	1.47081	1.3718	1013.8	739.0	60.25
72.3	1.47106	1.3725	1015.7	740.0	60.36
72.4	1.47131	1.3732	1017.7	741.1	60.48
72.5	1.47155	1.3738	1019.5	742.1	60.59
72.6	1.47180	1.3745	1021.5	743.2	60.71
72.7	1.47205	1.3752	1023.4	744.2	60.82
72.8	1.47230	1.3758	1025.4	745.3	60.94
72.9	1.47254	1.3765	1027.3	746.3	61.05
73.0	1.47284	1.3772	1029.3	747.4	61.17
73.1	1.47304	1.3778	1031.2	748.4	61.28
73.2	1.47329	1.3785	1033.2	749.5	61.40
73.3	1.47354	1.3792	1035.1	750.5	61.52
73.4	1.47379	1.3798	1037.1	751.6	61.63
73.5	1.47404	1.3805	1039.0	752.6	61.75
73.6	1.47429	1.3812	1040.9	753.6	61.86
73.7	1.47454	1.3818	1042.8	754.7	61.97
73.8	1.47479	1.3825	1044.8	755.7	62.09
73.9	1.47504	1.3832	1046.8	756.8	62.21
74.0	1.47534	1.3838	1048.6	757.8	62.32
74.1	1.47554	1.3845	1050.7	758.9	62.44
74.2	1.47579	1.3852	1052.6	759.9	62.56
74.3	1.47604	1.3858	1054.6	761.0	62.67
74.4	1.47629	1.3865	1056.5	762.0	62.79
74.5	1.47654	1.3871	1058.5	763.1	62.91
74.6	1.47679	1.3878	1060.4	764.1	63.02
74.7	1.47704	1.3885	1062.3	765.1	63.13
74.8	1.47730	1.3892	1064.4	766.2	63.26
74.9	1.47755	1.3898	1066.3	767.2	63.37
75.0	1.47785	1.3905	1068.3	768.3	63.49

Method OIV-MA-AS2-03A

Type I method

Total dry matter

OIV/OENO 377/2009;
OIV/OENO 387/2009)
OIV-OENO 465-2012

1 Definition

The total dry extract or the total dry matter includes all matter that is non-volatile under specified physical conditions. These physical conditions must be such that the matter forming the extract undergoes as little alteration as possible while the test is being carried out.

The sugar-free extract is the difference between the total dry extract and the total sugars. The reduced extract is the difference between the total dry extract and the total sugars in excess of 1 g/L, potassium sulfate in excess of 1 g/L, any mannitol present and any other chemical substances which may have been added to the wine.

The residual extract is the sugar-free extract less the fixed acidity expressed as tartaric acid.

2 Principle

The weight of residue obtained when a sample of wine, previously absorbed onto filter paper, is dried in a current of air, at a pressure of 20 - 25 mm Hg at 70°C.

3 Method

3.1 Apparatus

3.1.1 Oven:

Cylindrical basin (internal diameter: 27 cm, height: 6 cm) made of aluminum with an aluminum lid, heated to 70°C and regulated to 1°C.

A tube (internal diameter: 25 mm) connecting the oven to a vacuum pump providing a flow rate of 50 L/h. The air, previously dried by bubbling through concentrated sulfuric acid, is circulated in the oven by a fan in order to achieve

quick homogenous reheating. The rate of airflow is regulated by a tap and is to be 30-40 L per hour and the pressure in the oven is 25 mm of mercury.

The oven can then be used providing it is calibrated as in 3.1.3.

3.1.2 Dishes:

Stainless steel dishes (60 mm internal diameter, 25 mm in height) provided with fitting lids. Each dish contains 4-4.5 g of filter paper, cut into fluted strips 22 mm in length.

The filter paper is first washed with hydrochloric acid, 2 g/L, for 8 h, rinsed five times with water and then dried in air.

3.1.3 Calibration of apparatus and method

- a) Checking the seal of the dish lids. A dish, containing dried filter paper, with the lid on, after first being cooled in a dessicator containing sulfuric acid, should not gain more than 1 mg/h when left in the laboratory.
- b) Checking the degree of drying. A pure solution of sucrose, 100 g/L, should give a dry extract of $100 \text{ g} \pm 1 \text{ g/L}$.
- c) A pure solution of lactic acid, 10 g/L, should give a dry extract of at least 9.5 g/L.

If necessary, the drying time in the oven can be increased or decreased by changing the rate of airflow to the oven or by changing the pressure in order that these conditions should be met.

NOTE - The lactic acid solution can be prepared as follows: 10 mL of lactic acid is diluted to approximately 100 mL with water. This solution is placed in a dish and heated on a boiling water bath for 4 h, distilled water is added if the volume decreases to less than 50 mL (approx). Make up the solution to 1 liter and titrate 10 mL of this solution with alkali, 0.1 M. Adjust the lactic acid solution to 10 g/L.

3.2 Procedure

3.2.1 Weighing the dish

Place the dish containing filter paper in the oven for 1 h. Stop the vacuum pump and immediately place the lid on the dish on opening the oven. Cool in a dessicator and weigh to the nearest 0.1 mg: the mass of the dish and lid is p_0 g.

3.2.2 Weighing the sample

Place 10 mL of must or wine into the weigh dish. Allow the sample to be completely absorbed onto the filter paper. Place the dish in the oven for 2 h (or for the time used in the calibration of the standard in 3.1.3). Weigh the dish following the procedure 3.2.1 beginning "Stop the vacuum ...". The mass is p g.

Note: The sample weight should be taken when analyzing very sweet wines or musts.

3.3 Calculation

The total dry extract is given by:

$$(p - p_0) \times 100$$

For very sweet wines or musts the total dry extract is given by:

$$(p - p_0) \times \frac{p_{20}}{P} \times 1000$$

P = mass of sample in grams

p_{20} = density of wine or must in g/mL.

3.4 Expression of results

The total dry extract is expressed in g/L to one decimal place.

Note:

Calculate total dry extract by separately taking into account quantities of glucose and fructose (reducing sugars) and the quantity of saccharose, as follows:

Sugar-free extract = Total dry extract – reducing sugars (glucose + fructose)
– saccharose

In the case that the method of analysis allows for sugar inversion, use the following formula for the calculation:

Sugar-free extract = Total dry extract – reducing sugars (glucose + fructose)
- [(Sugars after inversion – Sugars before inversion) x 0,95]

Inversion refers to the process that leads to the conversion of a stereoisomer into compounds with reverse stereoisomerism. In particular, the process based on splitting sucrose into fructose and glucose, carried out by keeping acidified solutions containing sugars (100 ml solution containing sugars + 5 ml concentrated hydrochloric acid) for at least 15 min at 50°C or above in a water-bath (the water-bath is maintained at 60°C until the temperature of the solution reaches 50°C), is called *sugar inversion*. The final solution is laevo-rotatory due to the presence of fructose, while the initial solution is dextro-rotatory due to the presence of sucrose.

**COMPENDIUM OF INTERNATIONAL METHODS OF ANALYSIS - OIV
Total Dry Matter**

TABLE I
For the calculation of the total dry extract content (g/L)

Density to 2 decimal places	3 rd decimal place										
	0	1	2	3	4	5	6	7	8	9	
	Extract g/L										
1.00	0	2.6	5.1	7.7	10.3	12.9	15.4	18.0	20.6	23.2	
1.01	25.8	28.4	31.0	33.6	36.2	38.8	41.3	43.9	46.5	49.1	
1.02	51.7	54.3	56.9	59.5	62.1	64.7	67.3	69.9	72.5	75.1	
1.03	77.7	80.3	82.9	85.5	88.1	90.7	93.3	95.9	98.5	101.1	
1.04	103.7	106.3	109.0	111.6	114.2	116.8	119.4	122.0	124.6	127.2	
1.05	129.8	132.4	135.0	137.6	140.3	142.9	145.5	148.1	150.7	153.3	
1.06	155.9	158.6	161.2	163.8	166.4	169.0	171.6	174.3	176.9	179.5	
1.07	182.1	184.8	187.4	190.0	192.6	195.2	197.8	200.5	203.1	205.8	
		4									
1.08	208.4	211.0	213.6	216.2	218.9	221.5	224.1	226.8	229.4	232.0	
1.09	234.7	237.3	239.9	242.5	245.2	247.8	250.4	253.1	255.7	258.4	
1.10	261.0	263.6	266.3	268.9	271.5	274.2	276.8	279.5	282.1	284.8	
1.11	287.4	290.0	292.7	295.3	298.0	300.6	303.3	305.9	308.6	311.2	
1.12	313.9	316.5	319.2	321.8	324.5	327.1	329.8	332.4	335.1	337.8	
1.13	340.4	343.0	345.7	348.3	351.0	353.7	356.3	359.0	361.6	364.3	
1.14	366.9	369.6	372.3	375.0	377.6	380.3	382.9	385.6	388.3	390.9	
1.15	393.6	396.2	398.9	401.6	404.3	406.9	409.6	412.3	415.0	417.6	
1.16	420.3	423.0	425.7	428.3	431.0	433.7	436.4	439.0	441.7	444.4	
1.17	447.1	449.8	452.4	455.2	457.8	460.5	463.2	465.9	468.6	471.3	
1.18	473.9	476.6	479.3	482.0	484.7	487.4	490.1	492.8	495.5	498.2	
1.19	500.9	503.5	506.2	508.9	511.6	514.3	517.0	519.7	522.4	525.1	
1.20	527.8	-	-	-	-	-	-	-	-	-	

INTERPOLATION TABLE

4 th decimal place	Extract g/L	4 th decimal place	Extract g/L	4 th decimal place	Extract g/L
1	0.3	4	1.0	7	1.8
2	0.5	5	1.3	8	2.1
3	0.8	6	1.6	9	2.3

BIBLIOGRAPHY

- PIEN J., MEINRATH H., *Ann. Fals. Fraudes*, 1938, **30**, 282.
DUPAIGNE P., *Bull. Inst. Jus Fruits*, 1947, No 4.
TAVERNIER J., JACQUIN P., *Ind. Agric. Alim.*, 1947, **64**, 379.
JAULMES P., HAMELLE Mlle G., *Bull. O.I.V.*, 1954, **27**, 276.
JAULMES P., HAMELLE Mlle G., *Mise au point de chimie analytique pure et appliquée, et d'analyse bromatologique*, 1956, par J.A. GAUTIER, Paris, 4e série.
JAULMES P., HAMELLE Mlle G., *Trav. Soc. Pharm. Montpellier*, 1963, 243.
HAMELLE Mlle G., *Extrait sec des vins et des moûts de raisin*, 1965, Thèse Doct. Pharm. Montpellier.

Method OIV-MA-AS2-03B

Type IV method

Total dry matter
OIV/OENO 377/2009
OIV/OENO 387/2009)
OIV-OENO 465-2012

1 Definition

The total dry extract or the total dry matter includes all matter that is non-volatile under specified physical conditions. These physical conditions must be such that the matter forming the extract undergoes as little alteration as possible while the test is being carried out.

The sugar-free extract is the difference between the total dry extract and the total sugars. The reduced extract is the difference between the total dry extract and the total sugars in excess of 1 g/L, potassium sulfate in excess of 1 g/L, any mannitol present and any other chemical substances which may have been added to the wine.

The residual extract is the sugar-free extract less the fixed acidity expressed as tartaric acid.

2 Principle

The total dry extract is calculated indirectly from the specific gravity of the must and, for wine, from the specific gravity of the alcohol-free wine.

This dry extract is expressed in terms of the quantity of sucrose which, when dissolved in water and made up to a volume of one liter, gives a solution of the same gravity as the must or the alcohol-free wine.

3 Method

3.1 Procedure

Determine the specific gravity of a must or wine.

In the case of wine, calculate the specific gravity of the "alcohol free wine" using the following formula:

$$d_r = d_v - d_a + 1.000$$

where:

d_v = specific gravity of the wine at 20°C (corrected for volatile acidity ⁽¹⁾)

d_a = specific gravity at 20°C of a water-alcohol mixture of the same alcoholic

strength as the wine obtained using the formula:

$$d_r = 1.00180^{**} (r_v - r_a) + 1.000$$

where :

r_v = density of the wine at 20°C (corrected for volatile acidity ⁽¹⁾)

r_a = density at 20°C of the water alcohol mixture of the same alcoholic strength as the wine obtained from Table 1 of chapter *Alcoholic strength by volume* for a temperature of 20°C.

3.2 Calculation

Use the value for specific gravity of the alcohol free wine to obtain the total dry extract (g/L) from table I

3.3 Expression of results

The total dry extract is reported in g/L to one decimal place.

⁽¹⁾ NOTE: Before carrying out this calculation, the specific gravity (or the density) of the wine measured as specified above should be corrected for the effect of the volatile acidity using the formula:

$$d_v = d_{20} - 0.0000086 a \quad \text{or}$$

$$\rho_v = \rho_{20} - 0.0000086 a$$

where a is the volatile acidity expressed in milli-equivalents per liter.

** The coefficient 1.0018 approximates to 1 when r_v is below 1.05 which is often the case.

Note:

Calculate total dry extract by separately taking into account quantities of glucose and fructose (reducing sugars) and the quantity of saccharose, as follows:

Sugar-free extract = Total dry extract – reducing sugars (glucose + fructose)
– saccharose

In the case that the method of analysis allows for sugar inversion, use the following formula for the calculation:

Sugar-free extract = Total dry extract – reducing sugars (glucose + fructose) - [(Sugars after inversion – Sugars before inversion) x 0,95]

Inversion refers to the process that leads to the conversion of a stereoisomer into compounds with reverse stereoisomerism. In particular, the process based on splitting sucrose into fructose and glucose, carried out by keeping acidified solutions containing sugars (100 ml solution containing sugars + 5 ml concentrated hydrochloric acid) for at least 15 min at 50°C or above in a water-bath (the water-bath is maintained at 60°C until the temperature of the solution reaches 50°C), is called *sugar inversion*. The final solution is laevo-rotatory due to the presence of fructose, while the initial solution is dextro-rotatory due to the presence of sucrose.

**COMPENDIUM OF INTERNATIONAL METHODS OF ANALYSIS - OIV
Total Dry Matter**

TABLE I
For the calculation of the total dry extract content (g/L)

Density to 2 decimal places	3 rd decimal place										
	0	1	2	3	4	5	6	7	8	9	
	Extract g/L										
1.00	0	2.6	5.1	7.7	10.3	12.9	15.4	18.0	20.6	23.2	
1.01	25.8	28.4	31.0	33.6	36.2	38.8	41.3	43.9	46.5	49.1	
1.02	51.7	54.3	56.9	59.5	62.1	64.7	67.3	69.9	72.5	75.1	
1.03	77.7	80.3	82.9	85.5	88.1	90.7	93.3	95.9	98.5	101.1	
1.04	103.7	106.3	109.0	111.6	114.2	116.8	119.4	122.0	124.6	127.2	
1.05	129.8	132.4	135.0	137.6	140.3	142.9	145.5	148.1	150.7	153.3	
1.06	155.9	158.6	161.2	163.8	166.4	169.0	171.6	174.3	176.9	179.5	
1.07	182.1	184.8	187.4	190.0	192.6	195.2	197.8	200.5	203.1	205.8	
		4									
1.08	208.4	211.0	213.6	216.2	218.9	221.5	224.1	226.8	229.4	232.0	
1.09	234.7	237.3	239.9	242.5	245.2	247.8	250.4	253.1	255.7	258.4	
1.10	261.0	263.6	266.3	268.9	271.5	274.2	276.8	279.5	282.1	284.8	
1.11	287.4	290.0	292.7	295.3	298.0	300.6	303.3	305.9	308.6	311.2	
1.12	313.9	316.5	319.2	321.8	324.5	327.1	329.8	332.4	335.1	337.8	
1.13	340.4	343.0	345.7	348.3	351.0	353.7	356.3	359.0	361.6	364.3	
1.14	366.9	369.6	372.3	375.0	377.6	380.3	382.9	385.6	388.3	390.9	
1.15	393.6	396.2	398.9	401.6	404.3	406.9	409.6	412.3	415.0	417.6	
1.16	420.3	423.0	425.7	428.3	431.0	433.7	436.4	439.0	441.7	444.4	
1.17	447.1	449.8	452.4	455.2	457.8	460.5	463.2	465.9	468.6	471.3	
1.18	473.9	476.6	479.3	482.0	484.7	487.4	490.1	492.8	495.5	498.2	
1.19	500.9	503.5	506.2	508.9	511.6	514.3	517.0	519.7	522.4	525.1	
1.20	527.8	-	-	-	-	-	-	-	-	-	

INTERPOLATION TABLE

4 th decimal place	Extract g/L	4 th decimal place	Extract g/L	4 th decimal place	Extract g/L
1	0.3	4	1.0	7	1.8
2	0.5	5	1.3	8	2.1
3	0.8	6	1.6	9	2.3

BIBLIOGRAPHY

TABLE DE PLATO, d'après *Allgemeine Verwaltungsvorschrift für die Untersuchung von Wein und ähnlichen alkoholischen Erzeugnissen sowie von Fruchtsäften*, vom April 1960, Bundesanzeiger Nr. 86 vom 5. Mai 1960. - Une table très voisine se trouve dans *Official and Tentative Methods of Analysis of the Association of Official Agricultural Chemists*, Ed. A.O.A.C., Washington 1945, 815.

Ash

(A6 revised by OIV/OENO 377/2009)

1. Definition

The ash content is defined to be all those products remaining after igniting the residue left after the evaporation of the wine. The ignition is carried out in such a way that all the cations (excluding the ammonium cation) are converted into carbonates or other anhydrous inorganic salts.

2. Principle

The wine extract is ignited at a temperature between 500 and 550°C until complete combustion (oxidation) of organic material has been achieved.

3 Apparatus

- 3.1 boiling water-bath at 100°C;
- 3.2 balance sensitive to 0.1 mg;
- 3.3 hot-plate or infra-red evaporator;
- 3.4 temperature-controlled electric muffle furnace;
- 3.5 dessicator;
- 3.6 flat-bottomed platinum dish 70 mm in diameter and 25 mm in height.

4. Procedure

Pipette 20 mL of wine into the previously tared platinum dish (original weight p_0 g). Evaporate on the boiling water-bath, and heat the residue on the hot-plate at 200°C or under the infra-red evaporator until carbonization begins. When no more fumes are produced, place the dish in the electric muffle furnace maintained at $525 \pm 25^\circ\text{C}$. After 15 min or carbonization, remove the dish from the furnace, add 5 mL of distilled water, evaporate on the water-bath or under the infra-red evaporator, and again heat the residue to 525°C for 10 min.

If combustion (oxidation) of the carbonized particles is not complete, the following operations are repeated: washing the carbonized particles, evaporation of water, and ignition. For wines with a high sugar content, it is advantageous to add a few drops

of pure vegetable oil to the extract before the first ashing to prevent excessive foaming. After cooling in the desiccator, the dish is weighed (p_1 g).

The weight of the ash in the sample (20 mL) is then calculated as p
 $= (p_1 - p_0)$ g.

5. Expression of results

The weight P of the ash in grams per liter is given to two decimal places by the expression: $P = 50 p$.

Alkalinity of Ash

(A7 revised by OIV/OENO 377/2009)

1. Definition

The alkalinity of the ash is defined as the sum of cations, other than the ammonium ion, combined with the organic acids in the wine.

2. Principle

The ash is dissolved in a known (excess) amount of a hot standardized acid solution; the excess is determined by titration using methyl orange as an indicator.

3. Reagents and apparatus

- 3.1. Sulfuric acid solution, 0.05 M H₂SO₄
- 3.2. Sodium hydroxide solution, 0.1 M NaOH
- 3.3. Methyl orange, 0.1% solution in distilled water
- 3.4. Boiling water-bath

4. Procedure

Add 10 mL 0.05 M sulfuric acid solution (3.1) to the ash from 20 mL of wine contained in the platinum dish. Place the dish on the boiling water-bath for about 15 min, breaking up and agitating the residue with a glass rod to speed up the dissolution. Add two drops of methyl orange solution and titrate the excess sulfuric acid against 0.1 M sodium hydroxide (3.2) until the color of the indicator changes to yellow.

5. Expression of results

5.1. Method of calculation

The alkalinity of ash, expressed in milliequivalents per liter to one decimal place, is given by:

$$A = 5 (10 - n)$$

where n mL is the volume of sodium hydroxide, 0.1 M, used.

5.2. Alternative expression

The alkalinity of ash, expressed in grams per liter of potassium carbonate, to two decimal places, is given by:

$$A = 0.345 (10 - n)$$

BIBLIOGRAPHY

JAULMES P., *Analyse des vins*, Librairie Poulain, Montpellier, éd., 1951, 107.

Measurement of the oxidation-reduction potential in wines

(Resolution OENO 3/2000)

1. PURPOSE AND SCOPE OF APPLICATION:

The oxidation-reduction potential (EH) is a measure of the oxidation or reduction state of a medium. In the field of enology, oxygen and the oxidation-reduction potential are two important factors in the pre-fermentation processing of the grape harvest, the winemaking process, growing, and wine storage.

Proposals are hereby submitted for equipment designed to measure the Oxidation-reduction Potential in Wines and a working method for taking measurements under normal conditions. This method has not undergone any joint analysis, given the highly variable nature of the oxidation-reduction state of a particular wine, a situation which makes this step in the validation process difficult to implement. As a result, this is a class 4 method¹ intended basically for production.

2. UNDERLYING PRINCIPLE

The oxidation-reduction potential of a medium is defined as the difference in potential between a corrosion-proof electrode immersed in this medium and a standard hydrogen electrode linked to the medium. Indeed, only the difference in oxidation-reductions potentials of two linked systems can be measured. Consequently, the oxidation-reduction potential of the hydrogen electrode is considered to be zero, and all oxidation-reduction potentials are compared to it. The oxidation-reduction potential is a measurement value permitting expression of the instantaneous physico-chemical state of a solution. Only potentiometric volumetric analysis of the total oxidation-reduction pairs and an estimate of the oxidizing agent/reducing agent ratio can yield a true quantitative measurement. Oxidation-reduction potential is measured using combined electrodes, whether in wine or in another solution. This system usually involves the use of a

¹ In conformity with the classification detailed in the Codex Alimentarius.

COMPENDIUM OF INTERNATIONAL METHODS OF ANALYSIS– OIV
Measurement of oxidation reduction potential in wine

platinum electrode (measuring electrode) and a silver or mercurous chloride electrode (reference electrode).

3. EQUIPMENT

Although several types of electrodes exist, it is recommended that an electrode adapted for measuring the EH in wine be used. It is recommended that use be made of a double-jacket combined electrode linked to a reference electrode (see figure). This system incorporates a measuring electrode, and a double-jacket reference electrode, both of which are linked to an ion meter. The inner jacket of the reference electrode is filled with a solution of 17.1% KNO_3 ; trace amounts of AgCl ; trace amounts of Triton X-100; 5% KCl ; 77.9% de-ionized water; and for the measuring electrode, the solution is made up of <1% AgCl ; 29.8% KCl ; and 70% de-ionized water.

Modified Combined Electrode

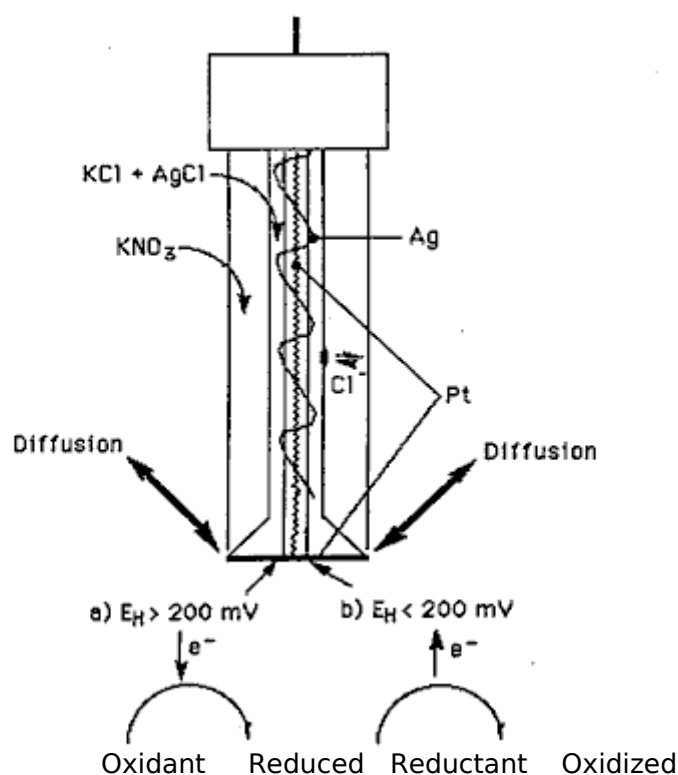

4. CLEANING AND CALIBRATION OF THE ELECTRODES

4.1. Calibration

The electrodes are calibrated using solutions with known, constant oxidation-reduction potentials. An equimolar solution (10 mM/l) of ferricyanide and potassium ferrous cyanide is used. Its composition is: 0.329g of $K_3Fe(CN)_6$; 0.422g of $K_4Fe(CN)_6$; 0.149g of KCl and up to 1000ml of water. At 20 °C this solution has an oxidation-reduction potential of 406 mV (± 5 mV), but this potential changes over time, thus requiring that the solution not be stored for more than two weeks in the dark.

4.2. Cleaning the Platinum in the Electrode

The electrode platinum should be cleaned by immersing it in a solution of 30% hydrogen peroxide by volume for one hour, then washing it with water. Complete cleaning in water is required after each series of measurement. The system is normally cleaned after each week of use.

5. WORKING METHOD

5.1. Filling the Inner Jacket

The composition of the double jacket varies depending on the type of medium for which the EH is being measured (Table below).

Table
Composition of the Filler Solution in the Double Jacket of the
Electrode as a Function of the Medium Measured

Medium to be measured	Solution Composition of the jacket
1 Dry wines	Ethanol 12% by vol., 5g tartaric acid, NaOH N up to pH 3.5, distilled water up to 1000 ml
2 Sweet wines	Solution 1 plus 20 g/l sucrose
3 Special sweet wines	Solution 2 plus 100 mg/l of SO_2 ($KHSO_3$)
4 Brandies	Ethanol 50% by vol., acetic acid up to pH 5, distilled water up to 1000 ml.

5.2. Balancing the Electrode with the Medium to Be Measured

Before taking any measurements, the electrodes must be calibrated in Michaelis solution, then stabilized for 15 minutes in a wine, if the measurements are to be taken in wines. Next, for measurements taken on site, measurements are read after the electrodes have been immersed in the medium for 5 minutes. For laboratory measurements, the stability index is the $\Delta\text{EH}(\text{mV}) / T$ (minutes) ratio ; when this latter is ≤ 0.2 , the potential can be read.

5.3. Measurements Under Practical Conditions

Measurements are systematically taken on site without any handling that could change the oxidation-reduction potential values. When taking measurements in storehouses, casks, vats, etc. care should be taken to record temperature, pH and dissolved oxygen content (method under preparation) at the same time as the EH measurement is taken, as these measurements will subsequently be used to interpret results. For wines in bottles, the measurement is taken in the wine after letting it sit in a room whose temperature is 20 °C, immediately after the container is opened, under a constant flow of nitrogen, and after immersing the entire electrode unit in the bottle.

5.4. Expression of Results

Findings are recorded in mV as compared with the standard hydrogen electrode.

Method OIV-MA-AS2-07A

Chromatic Characteristics

2. Principle of the methods

A spectrophotometric method which makes it possible to determine the tristimulus values and the three chromaticity coefficients required to specify the color as described by the CIE (*Commission internationale de l'Éclairage*).

WITHDRAWN
(replaced by OIV-MA-AS2-11)

Method OIV-MA-AS2-07B

Type IV method

Chromatic Characteristic
(Method A0 modified by OENO 1/2006
Modified by OIV-OENO 667-2022)

1. Definitions

The "chromatic characteristics" of a wine are its luminosity and chromaticity. Luminosity depends on transmittance and varies inversely with the intensity of color of the wine. Chromaticity depends on dominant wavelength (distinguishing the shade) and purity.

Conventionally, and for the sake of convenience, the chromatic characteristics of red and rosé wines are described by the intensity of color and shade, in keeping with the procedure adopted as the working method.

2. Principle of the methods

(applicable to red and rosé wines)

A spectrophotometric method whereby chromatic characteristics are expressed conventionally, as given below:

- The intensity of color is given by the sum of absorbencies (or optical densities) using a 1 cm optical path and radiations of wavelengths 420, 520 and 620 nm.
- The shade is expressed as the ratio of absorbance at 420 nm to absorbance at 520 nm.

3. Method

3.1. *Apparatus*

3.1.1 Spectrophotometer enabling measurements to be made between 300 and 700 nm.

3.1.2 Glass cells (matched pairs) with optical path b equal to 0.1, 0.2, 0.5, 1 and 2 cm.

3.2. *Preparation of the sample*

If the wine is cloudy, clarify it by centrifugation; young or sparkling wines must have the bulk of their carbon dioxide removed by agitation under vacuum.

3.3. *Method*

The optical path b of the glass cell used must be chosen so that the measured absorbance A , falls between 0.3 and 0.7.

COMPENDIUM OF INTERNATIONAL METHODS OF ANALYSIS–OIV
Chromatic Characteristics

Take the spectrophotometric measurements using distilled water as the reference liquid, in a cell of the same optical path b , in order to set the zero on the absorbance scale of the apparatus at the wavelengths of 420, 520 and 620 nm.

Using the appropriate optical path b , read off the absorbencies at each of these three wavelengths for the wine.

3.4. Calculations

Calculate the absorbencies for a 1 cm optical path for the three wavelengths by dividing the absorbencies found (A_{420} , A_{520} and A_{620}) by b , in cm.

3.5. Expression of Results

The color intensity I is conventionally given by:

$$I = A_{420} + A_{520} + A_{620}$$

and is expressed to three decimal places.

The shade N is conventionally given by:

$$N = \frac{A_{420}}{A_{520}}$$

and is expressed to three decimal places.

**COMPENDIUM OF INTERNATIONAL METHODS OF ANALYSIS–OIV
Chromatic Characteristics**

TABLE 1

Converting absorbance into transmittance (T%)

Method: find the first decimal figure of the absorbance value in the left-hand column (0-9) and the second decimal figure in the top row (0-9).

Take the figure at the intersection of column and row: to find the transmittance, divide the figure by 10 if absorbance is less than 1, by 100 if between 1 and 2 and by 1000 if between 2 and 3.

Note: The figure in the top right hand corner of each box enables the third decimal figure of the absorbance to be determined by interpolation.

	0	1	2	3	4	5	6	7	8	9
0	1000 ²³	977 ²²	955 ²²	933 ²¹	912 ²¹	891 ²⁰	871 ²⁰	851 ¹⁹	932 ¹⁹	813 ¹⁹
1	794 ¹⁸	776 ¹⁸	759 ¹⁷	741 ¹⁷	724 ¹⁶	708 ¹⁶	692 ¹⁶	676 ¹⁵	661 ¹⁵	646 ¹⁵
2	631 ¹⁴	617 ¹⁴	603 ¹⁴	589 ¹⁴	575 ¹³	562 ¹³	549 ¹³	537 ¹²	525 ¹²	513 ¹²
3	501 ¹¹	490 ¹¹	479 ¹¹	468 ¹¹	457 ¹⁰	447 ⁹	436 ⁹	427 ¹⁰	417 ¹⁰	407 ⁹
4	398 ⁹	389 ⁹	380 ⁹	371 ⁸	363 ⁸	355 ⁸	347 ⁸	339 ⁷	331 ⁷	324 ⁸
5	316 ⁷	309 ⁷	302 ⁷	295 ⁷	288 ⁶	282 ⁷	275 ⁶	269 ⁶	263 ⁶	257 ⁶
6	251 ⁶	245 ⁵	240 ⁶	234 ⁵	229 ⁵	224 ⁵	219 ⁵	214 ⁵	209 ⁵	204 ⁵
7	199 ⁴	195 ⁵	190 ⁴	186 ⁴	182 ⁴	178 ⁴	174 ⁴	170 ⁴	166 ⁴	162 ⁴
8	158 ³	155 ⁴	151 ³	148 ⁴	144 ⁴	141 ³	138 ³	135 ³	132 ³	129 ³
9	126 ³	123 ³	120 ³	117 ²	115 ³	112 ²	110 ³	107 ²	105 ³	102 ²

Example:

Absorbance	0.47	1.47	2.47	3.47
T%	33.9%	3.4%	0.3%	0%

Transmittance (T%) is expressed to the nearest 0.1%.

COMPENDIUM OF INTERNATIONAL METHODS OF ANALYSIS—OIV
Chromatic Characteristics

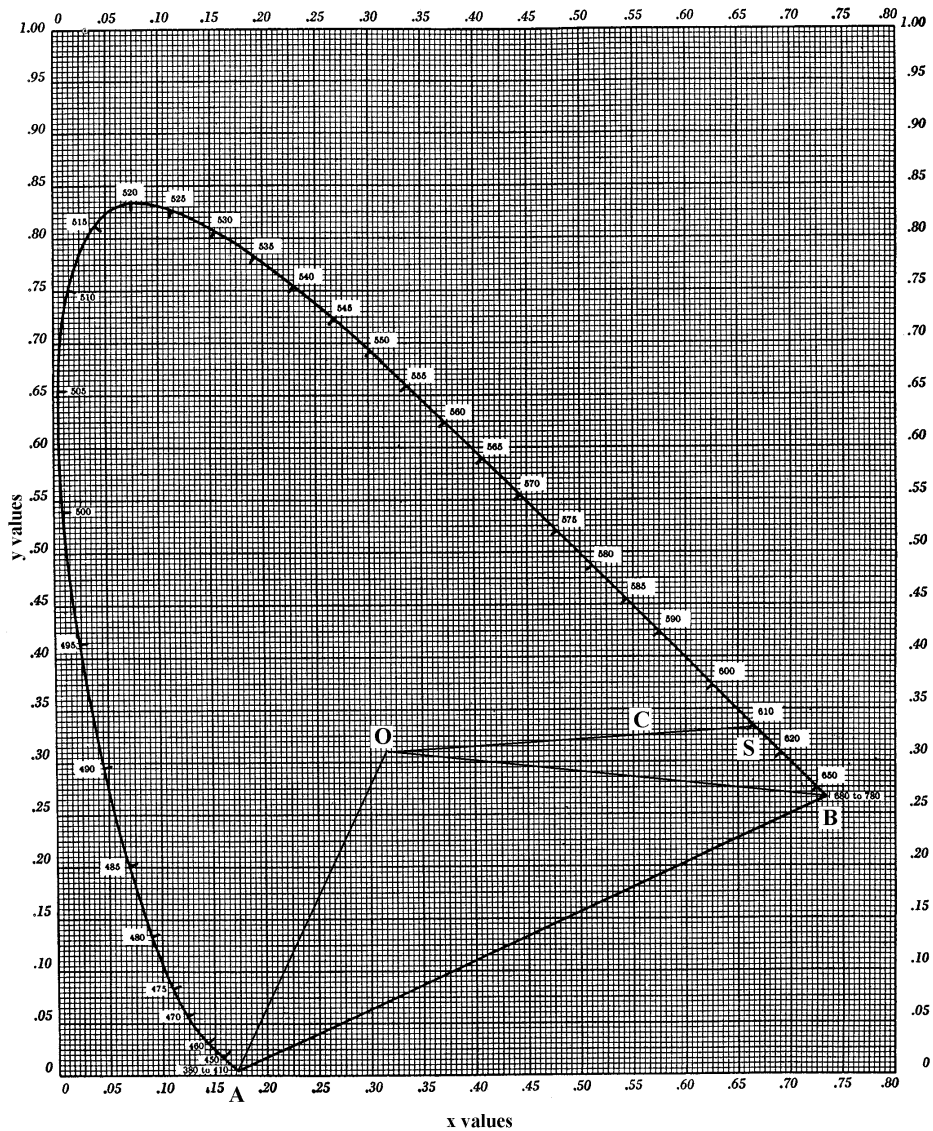

FIGURE 1

Chromaticity diagram, showing the locus of all colors of the spectrum

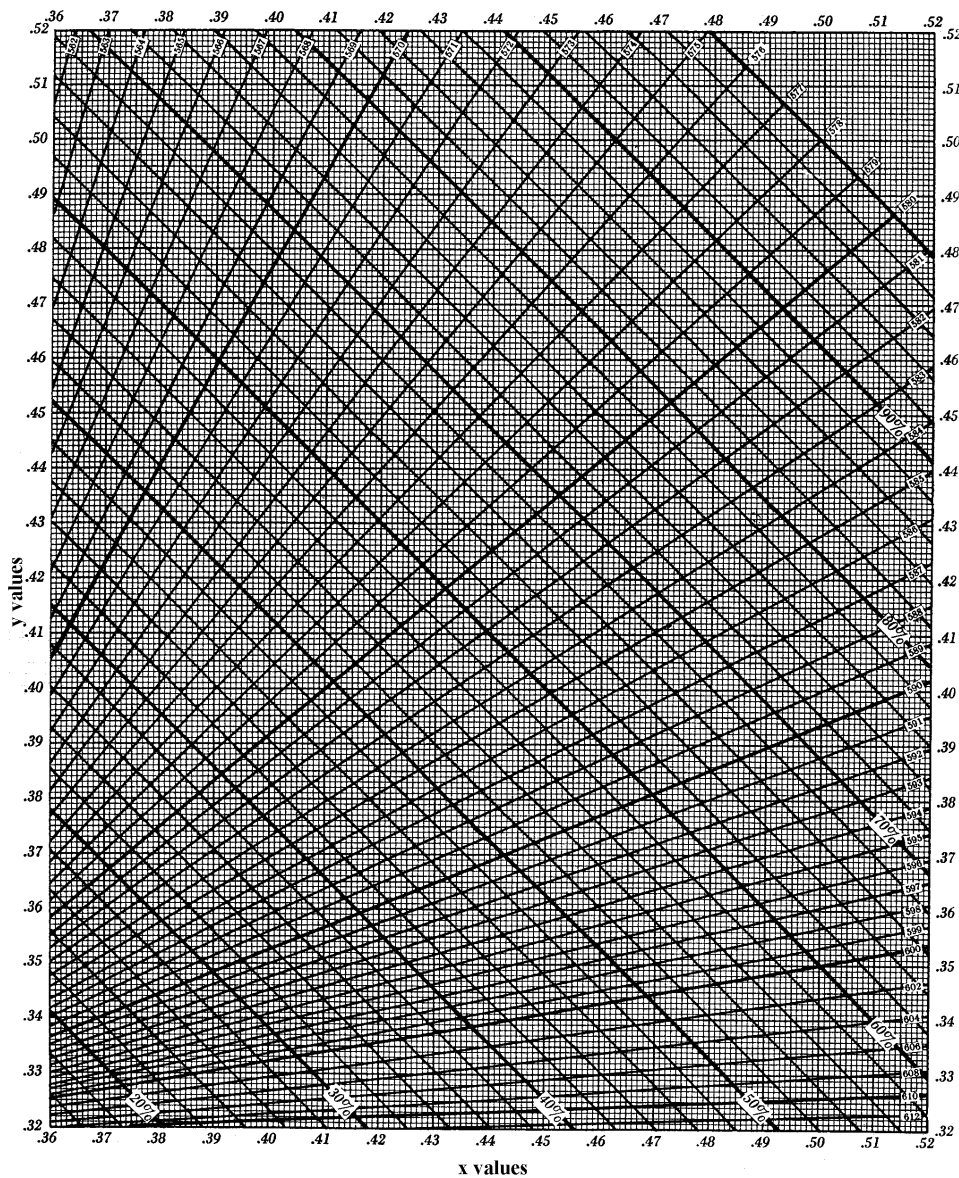

FIGURE 2
Chromaticity diagram for pure red wines and brick red wines

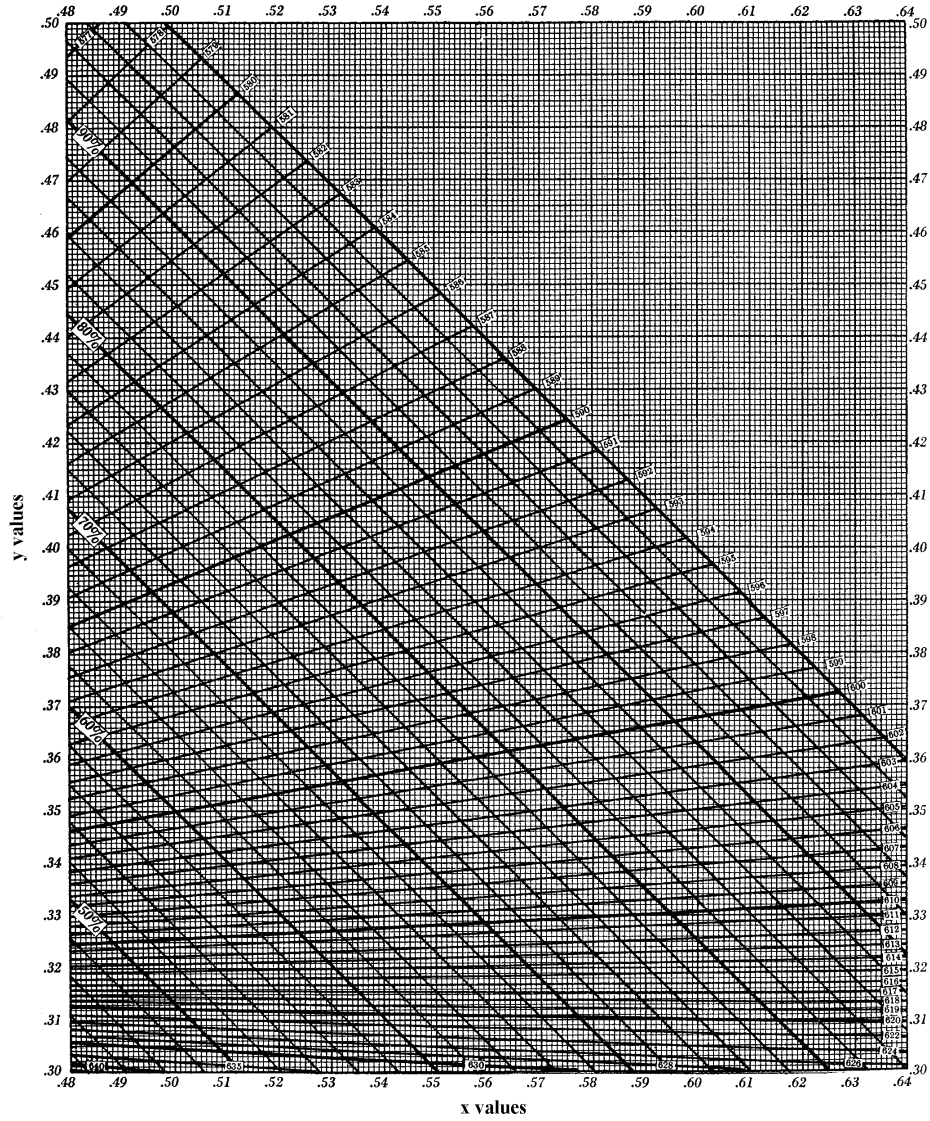

FIGURE 3

Chromaticity diagram for pure red wines and brick red wines

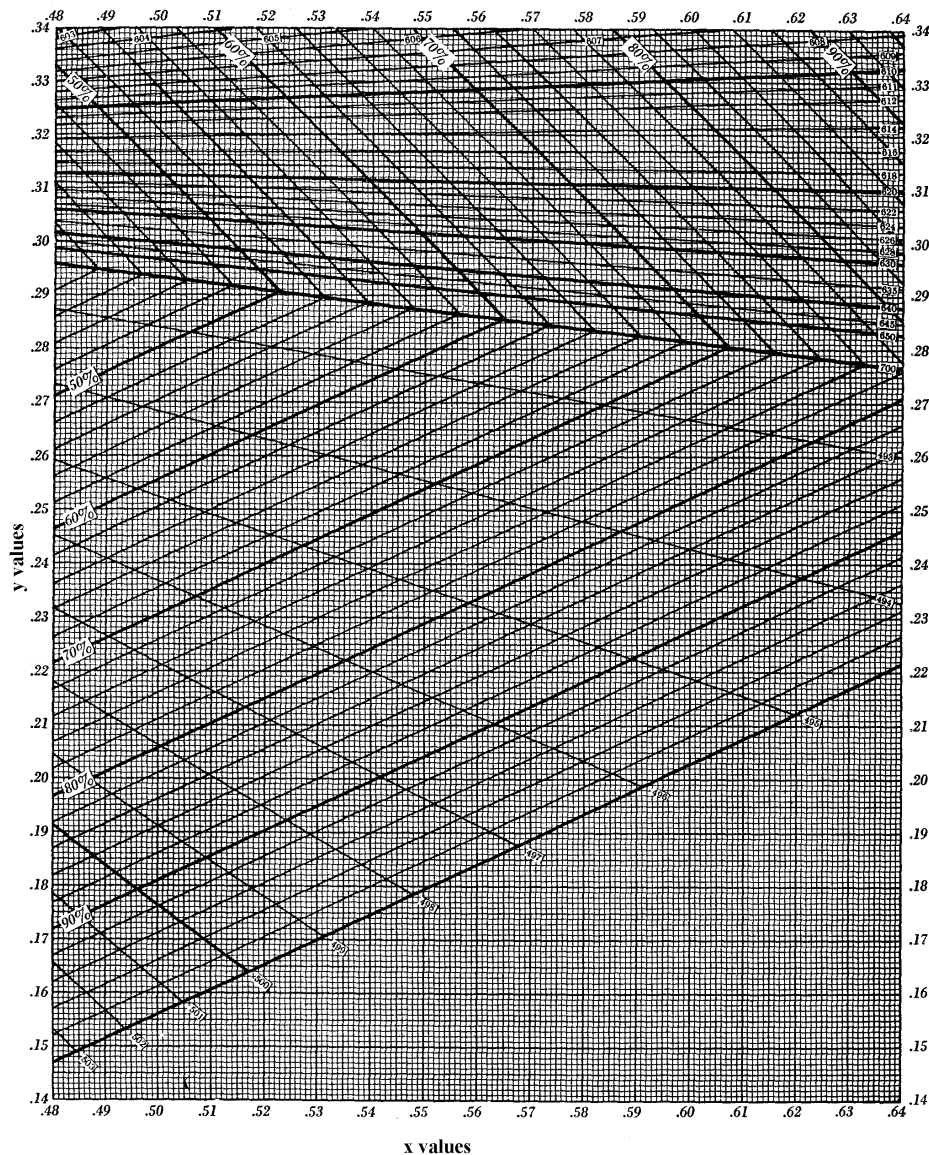

FIGURE 4

Chromaticity diagram for pure red wines and purple wines

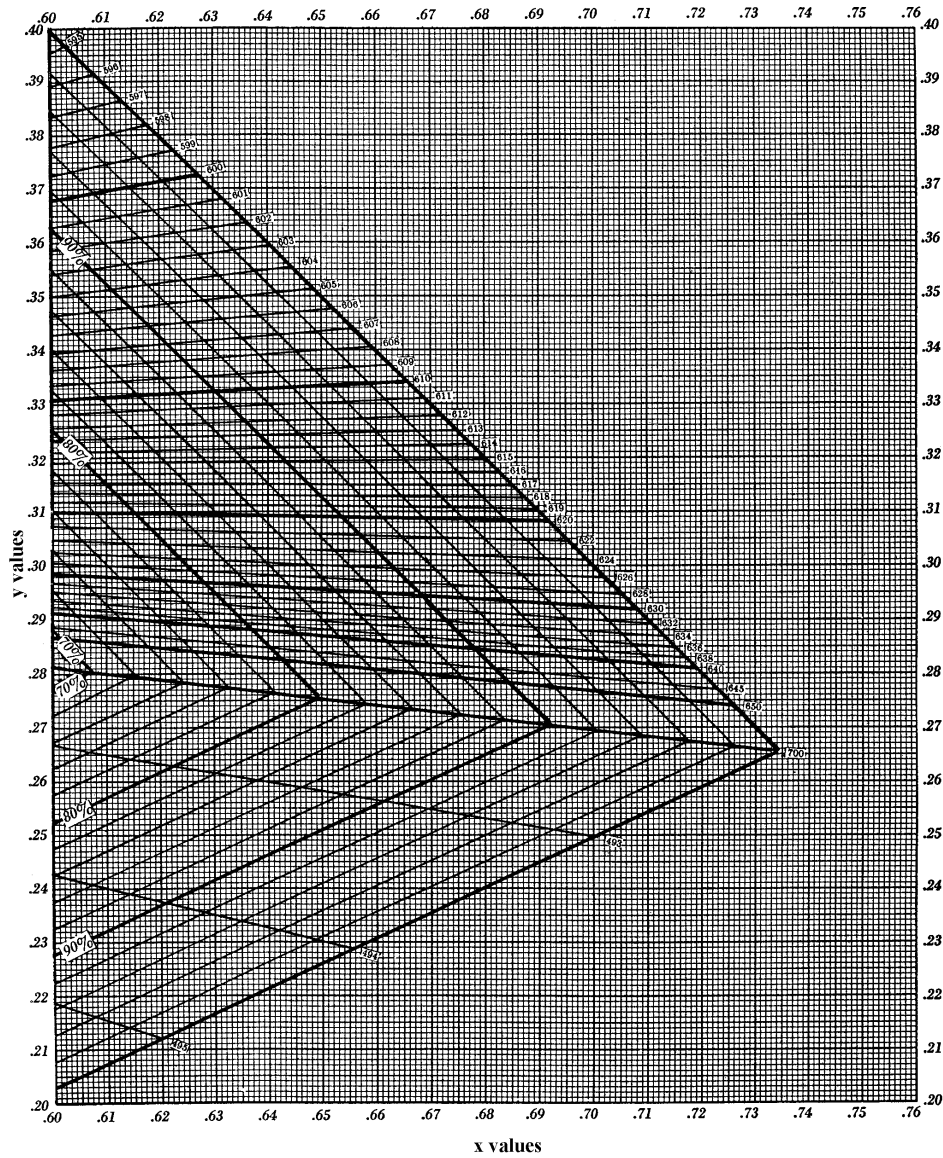

FIGURE 5

Chromaticity diagram for pure red wines and purple red wines

COMPENDIUM OF INTERNATIONAL METHODS OF ANALYSIS—OIV
Chromatic Characteristics

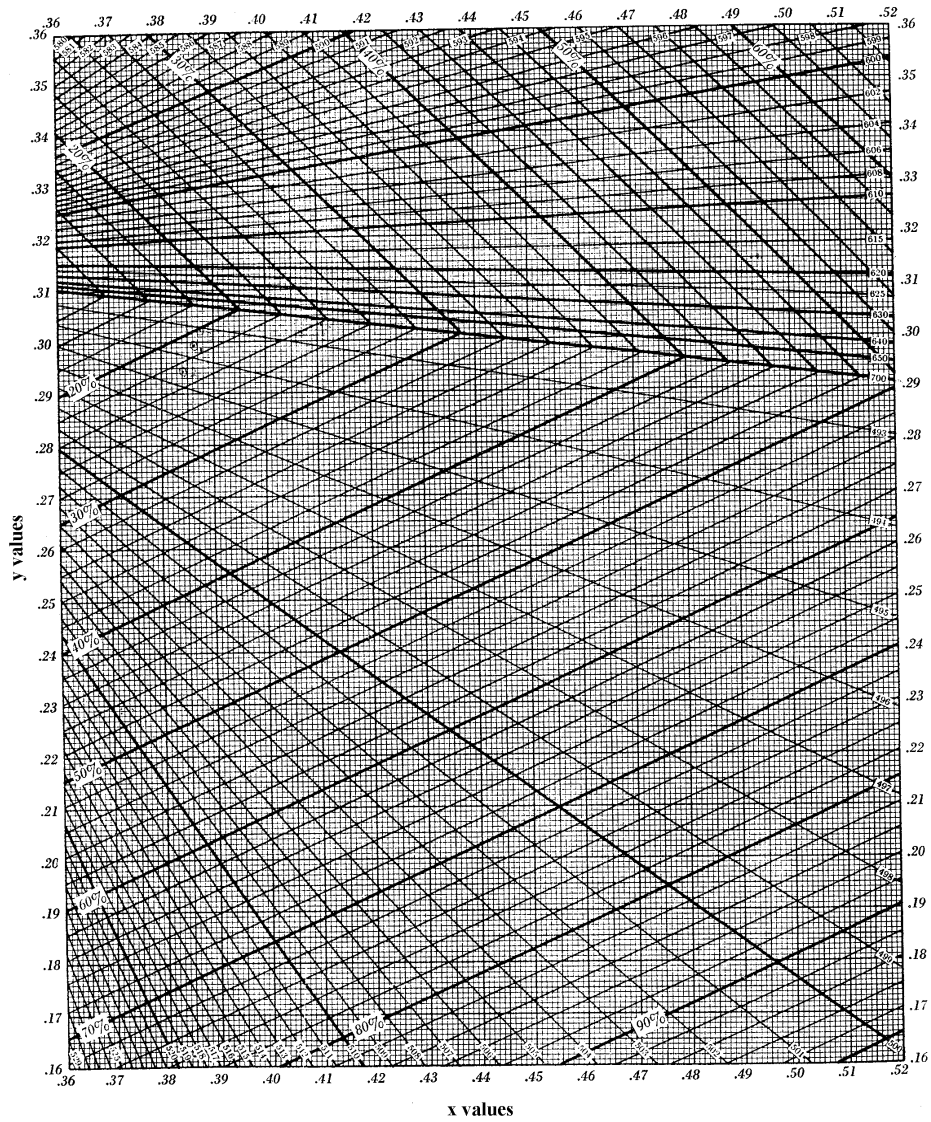

FIGURE 6

Chromaticity diagram for brick red wines and purple red wines

BIBLIOGRAPHY

- BOUTARIC A., FERRE L., ROY M., *Ann. Fals. Fraudes*, 1937, **30**, 196.
SUDRAUD P., *Ann. Technol. Agric.*, 1958, no 2, 203.
MARECA CORTES J., *Atti Acc. Vite Vino*, 1964, 16.
GLORIES Y., *Conn. vigne et Vin*, 1984, **18**, no 3, 195.

Annex: Operative instructions for the determination of Chromatic Characteristics of wines and/or musts obtained by grape varieties characterized by high concentrations of colouring pigments and/or high sulfur dioxide levels

1. Principle of the method

1.1. Field of application

Applicable to red wine with high concentrations of colouring pigments, must, and must with high sulphur dioxide levels.

A spectrophotometric method whereby chromatic characteristics are expressed, conventionally, as given below:

- The intensity of colour is given by the sum of absorbencies (or O.D. = Optical Densities) using a 1 cm optical path and radiation of wavelengths 420, 520 and 620 nm.
- The shade is expressed as the ratio of absorbance at 420 nm to absorbance at 520 nm.

For grape varieties characterized by high concentrations of colouring pigments, given the nature of the chemical structure of these substances, the determination of the chromatic characteristics requires the dilution of the sample with a buffered solvent at pH 3.2. The use of a buffered solvent compared to dilution with water reduces the effect of the matrix and normalizes the O.D as the dilution increases.

2. Method

2.1. Apparatus

2.1.1. Spectrophotometer enabling measurements to be made between 300 and 700 nm.

2.1.2. Glass cuvettes or single use plastic cuvettes with optical path equal to 1 cm.

2.1.3. Volumetric glassware with variable volume according to needs

2.1.4. Syringe filter 0.45 µm

2.2. Reagents

2.2.1. Type II water for analytical use, ISO 3696 standard, or of equivalent purity

2.2.2. Tartaric acid \geq 99.5% (CAS 87-69-4)

2.2.3. Sodium hydroxide NaOH 1 N (CAS 1310-73-2)

2.2.4. Hydrogen peroxide 30% w/w (CAS 7722-84-1)

2.3. Working solutions

2.3.1. Buffer at pH 3.20

Daily preparation: weigh \pm 0.1 g of tartaric acid (2.2.2) in a 1000 mL volumetric flask, add 35 ml of NaOH 1 N (2.2.3) and make up to 1000 mL with water (2.2.1). Check the pH with a pH meter and verify that pH is 3.20 ± 0.05 . The solution should be checked and filtered (2.1.4) at the time of use.

2.3.2. Hydrogen peroxide 3% (v/v)

Dilute 1.0 mL of hydrogen peroxide (2.2.4) to 10 ml. The solution should be prepared at the time of use.

2.4. Preparation of the sample

If the sample is cloudy, clarify it by centrifugation (10 min, 1146 rcf); If there is carbon dioxide remove it by agitation under vacuum (or similar systems).

In the case of grape must whose alcoholic fermentation is inhibited by adding sulphur dioxide, add 0.1 mL of 3% hydrogen peroxide solution (2.3.2) per mL of sample used and make up to volume, depending on the dilution chosen, with the buffer solution at pH 3.2 (2.3.1). Wait 20 minutes, then proceed with spectrophotometric reading.

2.5. Spectrophotometric reading for wine and must with high colour intensity or high sulphur dioxide levels

Take the spectrophotometric measurements of the samples: the absorbance (A) will fall between 0.3 and 1.0 (the absorbance

acceptability range can be extended if instrumental technology allows it) If the A-value is above the maximum limit, make an appropriate number of dilutions (d) of the sample using the buffer solution (2.3.1) to meet the acceptability criteria.

Take the spectrophotometric measurements using the buffer solution as the reference liquid to set the absorbance scale of the apparatus to zero at the wavelengths of 420, 520 and 620 nm.

2.6. Calculations

Calculate the optical densities (O.D.) for each of the three wavelengths by multiplying the detected absorbances (A_{420} , A_{520} and A_{620}) by the number of dilutions made (d):

$$\boxed{\text{DO } 420 \text{ nm} = A_{420} \times d}$$

$$\boxed{\text{DO } 520 \text{ nm} = A_{520} \times d}$$

$$\boxed{\text{DO } 620 \text{ nm} = A_{620} \times d}$$

2.7. Expression of results

The colour intensity (I) is conventionally given by:

$$\boxed{I = A_{420} + A_{520} + A_{620}}$$

and is expressed to three decimal places.

The shade (N) is conventionally given by:

$$\boxed{N = A_{420}/A_{520}}$$

and is expressed to three decimal places.

Method OIV-MA-AS2-08

Type IV method

Wine turbidity

(Resolution OENO 4/2000, revised by OIV/OENO 377/2009)

Determination by Nephelometric Analysis

1. Warning

Measurements of turbidity are largely dependent on the design of the equipment used. Therefore, comparative measurements from one instrument to another are not possible unless the same measuring principle is used.

The primary known sources of errors, which are linked to the type of turbidimeter employed, are:

- effect of stray light,
- effect of product color, especially in cases with low cloudiness values,
- electronic shifting due to aging electronic components,
- type of light source, photo detector and the dimensions and type of measurement the cell.

The present method uses a nephelometer incorporating a **double beam with optical compensation** design.

This category of instrument makes it possible to compensate for: electronic shift, fluctuations of mains voltage, and, in part, wine color. Furthermore, calibration is highly stable.

It should be noted that this method does not lend itself to a collation of data from various sources, given the impossibility of conducting an analysis in collaboration with others.

2. Purpose

The purpose of this document is to describe an optical method capable of measuring the turbidity (or diffusion) index of wine.

3. Scope of application

This method is used in the absence of instruments allowing a completely faithful duplication of measurements from one device to another, as well as full compensation for wine color. Therefore, findings are given for informational purposes only, and must be considered with caution.

Above all, this technique is intended for use in production, where it is the most objective criterion of the measurement of clarity.

This method, which cannot be validated accordingly to internationally recognized criteria, will be classified as class 4¹.

4. General principle

Turbidity is an optical effect.

The diffusion index is an intrinsic property of liquids that makes it possible to describe their optical appearance. This optical effect is produced by the presence of extremely fine particles scattered in a liquid dispersion medium. The refraction index of these particles differs from that of the dispersion medium.

If a light is shown through a quantity of optically clean water placed in a container of known volume and the luminous flux diffused with respect to an incident beam is measured, the recorded value of this diffused flux will allow description of the molecular diffusion in the water.

If the value obtained for the water thus analyzed is greater than that of the molecular diffusion, which remains constant for a given wavelength, the same incident flux at the same angle measurement, in a tank of the same shape and at a given temperature, the difference can be attributed to the light diffused by solid, liquid or gaseous particles suspended in the water.

The measurement (taken as described) of the diffused luminous flux constitutes a nephelometric measurement.

5. Definitions

5.1. Turbidity

Reduction of the transparency of a liquid due to the presence of undissolved substances.

5.2. Units of Measurement of the Turbidity Index

The unit of turbidity used is: NTU - NEPHELOMETRIC TURBIDITY UNIT, which is the value corresponding to the measurement of the light diffused by a standard formazine suspension prepared as described under point 6.2.2, at a 90° angle to the direction of the incident beam.

6. Preparing the reference Formazine suspension (1)

6.1. Reagents

All reagents must be of recognized analytical quality.

¹(2) Care must be given to the precautions for handling, since Formazine is somewhat toxic.

They must be stored in glass flasks.

6.1.1 Water for Preparing Control Solutions.

Soak a filter membrane with a pore size of 0.1µm (like those used in bacteriology) for one hour in 100 ml of distilled water. Filter 250 ml distilled water twice through this membrane, and retain this water for preparation of standard solutions.

6.1.2. Formazine (C₂H₄N₂) Solutions

The compound known as formazine, whose formula is C₂H₄N₂, is not commercially available. It can be produced using the following solutions:

Solution A: Dissolve 10.0 g hexamethylene-tetramine (CH₂)₆N₄ in distilled water prepared according to the instructions in 6.1.1. Then fill to a volume of 100 ml using distilled water.

Solution B: Dissolve 1.0 g of hydrazinium sulfate, N₂H₆SO₄, in distilled water prepared according to the instruction in 6.1.1. Then fill to a volume of 100 ml using distilled water prepared according to 6.1.1.

WARNING: Hydrazinium sulfate is poisonous and may be carcinogenic.

6.2 Working Method

Mix 5 ml of Solution A and 5 ml of Solution B. Dilute the solution to a volume of 100 ml with water after 24 hours at 25 °C ± 3 °C (6.1.1).

The turbidity of this standard solution is 400 NTU.

This standard suspension will keep for approximately 4 weeks at room temperature in the dark.

By diluting to 1/400 with recently prepared distilled water, a turbidity of 1 NTU will be obtained.

This solution remains stable for one week only.

N.B.: Standard formazine solutions have been compared to standard polymer-based solutions. The differences observed may be considered negligible. Nonetheless, polymer-based standard solutions have the following drawbacks: they are very expensive and they have a limited useful life. They must be handled with care to avoid breaking the polymer particles, as breakage would

alter the turbidity value. Polymer use is suggested as an alternative to formazine.

7. Optical Measurement Principle

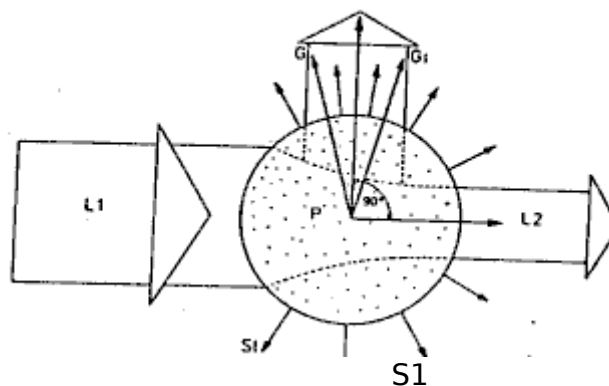

Measurement principle:

L1 = Incident light beam

L2 = Beam after passing through sample

P = Sample

St = diffused light

G/G1 = Limiting rays from the diffused light beam used for measurement

The diffused light should be observed at an angle of 90° to the direction of propagation of the incident beam.

8. Instrumentation

8.1. *Optical principle of the dual-beam and optical compensation nephelometer*

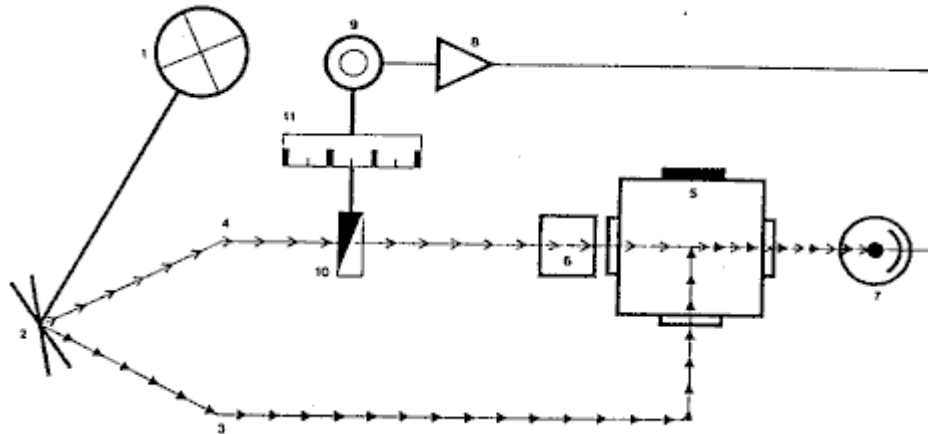

A light source (1) powered by the electricity network projects a beam of light onto an oscillating mirror (2) which alternately reflects a measuring beam (3) and a comparison beam (4) at a rate of approximately 600 times per second.

The measuring beam (3) propagates through the fluid to be measured (5) while the comparison beam (4) propagates through an optically stable turbidity-comparison standard fluid (6).

The light diffused by the particles producing turbidity in the fluid (5) and the light diffused by the standard comparison solution (6) are alternately received by a photoelectric cell (7).

Accordingly, this cell receives a measuring beam (3) and a comparison (4) having the same frequency, but different whose luminous intensities.

The photoelectric cell (7) transforms these unequal luminous intensities into electric current which are in turn amplified (8) and fed to a synchronous motor (9) functioning as a servo-motor.

This motor uses a mechanical measuring diaphragm (10) to vary the intensity of the control beam, until the two beams strike the photoelectric cell with equal luminous intensity.

This equilibrium state allows the solid particle content of the fluid to be determined.

The absolute value of the measurement depends on the dimensions of the standard comparison beam and on the position of the diaphragm.

8.2. Characteristics

Note: In order to take these measurements, regardless of the color of the wine, the nephelometer must be equipped with an additional interferential filter allowing measurement at a wavelength of 620 nm. However, the interferential filter is not needed if the light source is an infrared one.

8.2.1 The width of the spectral band of the incident radiation should be less than or equal to 60 nm.

8.2.2 There should be no divergence in the parallelism of the incident radiation, and convergence must not exceed 1.5°.

8.2.3 The angle of measurement between the optical axis of the incident radiation and that of the diffused radiation should be 90° ± 2.5°.

8.2.4 The apparatus must not cause error due to stray light greater than:

- 0.01 NTU of random light error
within a range of:
 - 0 to 0.1 NTU.

9. Operating Method for measurement

9.1. Checking the Apparatus

Before taking any measurement or series of measurements, check to ensure the proper electrical and mechanical operation of the apparatus in accordance with the recommendations of the manufacturer.

9.2. Check Measurement Scale Adjustment

Before taking any measurement or series of measurements, use a previously calibrated instrument to check its measurement scale adjustment consistent with the principle underlying its design.

9.3 Cleaning the Measuring Unit

With the greatest care, clean the measuring tank before all analyses. Take all necessary precautions to avoid getting dust in the apparatus and especially in the measuring unit, before and during determination of the turbidity index.

9.4. Taking Measurements

- The operating temperature should be between 15° and 25 °C (Take the temperature of the wine to be measured into consideration to ensure proper comparison). Prior to taking

the measurement, carefully homogenize the product and, without making any abrupt movement that could create an emulsion, the flask holding the product to be analyze.

- Carefully wash the measuring tank twice with a small amount of the product to be analyzed.
- Carefully pour the product to be analyzed into the measuring tank, taking care to avoid any turbulence in the flow of the liquid, since this would lead to the formation of air bubbles. Carry out the test measurements.
- Wait one minute if the index value is stable.
- Record the resulting turbidity index.

10. Expressing the results

The turbidity index of the wine undergoing analysis is recorded and expressed in:

*** NTU**

- * if turbidity is less than 1 NTU, round off to 0.01 NTU
- * if turbidity is between 1 NTU and 10 NTU, round off to 0.1 NTU
- * if turbidity is between 10 NTU and 100 NTU, round off to 1 NTU

11. Test report

The test should contain the following information:

- a) reference to this method
- b) the results, expressed as indicated in 10
- c) any detail or occurrence that may have affected the findings.

BIBLIOGRAPHY

-AFNOR

Standard NF EN 27027 (ISO 7027) - April 1994
"Water Quality = Turbidity Analysis"

-OIV

Compendium of International Methods for Spirits, Alcohols and the Aromatic Fractions in Beverages - 1994
"Turbidity – Nephelometric Analysis Method"

SIGRIST PHOTOMETER SA, CH 6373 Ennetburgen
"Excerpts from technical instructions for nephelometers"

Method OIV-MA-AS2-09

**Method for isotopic ratio $^{18}\text{O}/^{16}\text{O}$
of water content in wines**

(Resolution OENO 2/96)

WITHDRAWN
(replaced by OIV-MA-AS2-12)

Folin-Ciocalteu Index

(Recueil OIV ed.1990 revised by OIV/OENO 377/2009)

1. Definition

The Folin-Ciocalteu index is the result obtained by applying the method described below.

2. Principle

All phenolic compounds contained in wine are oxidized by Folin-Ciocalteu reagent. This reagent is formed from a mixture of phosphotungstic acid, $H_3PW_{12}O_{40}$, and phosphomolybdic acid, $H_3PMo_{12}O_{40}$, which, after oxidation of the phenols, is reduced to a mixture of blue oxides of tungsten, W_8O_{23} , and molybdenum, Mo_8O_{23} . The blue coloration produced has a maximum absorption in the region of 750 nm, and is proportional to the total quantity of phenolic compounds originally present.

3. Apparatus

Normal laboratory apparatus, in particular:

3.1 100 mL volumetric flasks.

3.2 Spectrophotometer capable of operating at 750 nm.

4. Reagents

4.1 Folin-Ciocalteu reagent

This reagent is available commercially in a form ready for use.

Alternatively it may be prepared as follows: dissolve 100 g of sodium tungstate, $Na_2WO_4 \cdot 2H_2O$, and 25 g of sodium molybdate, $Na_2MoO_4 \cdot 2H_2O$, in 700 mL of distilled water. Add 50 mL phosphoric acid 85% ($\rho_{20} = 1.71$ g/mL), and 100 mL of concentrated hydrochloric acid ($\rho_{20} = 1.19$ g/mL). Bring to the boil and reflux for 10 hours. Then add 150 g of lithium sulfate, $Li_2SO_4 \cdot H_2O$, and a few drops of bromine and boil for 15 minutes. Allow to cool and make up to one liter with distilled water.

4.2 Anhydrous sodium carbonate, Na_2CO_3 , made up into a 20% (m/v) solution.

5. Procedure

5.1 *Red wine*

Introduce the following into a 100 mL volumetric flask (3.1) strictly in the following order:

**COMPENDIUM OF INTERNATIONAL METHODS OF ANALYSIS -
OIV
Folin-Ciocalteu Index**

1 mL of the wine, previously diluted 1/5,
50 mL of distilled water,
5 mL of Folin-Ciocalteu reagent (4.1),
20 mL of sodium carbonate solution (4.2).

Bring to 100 mL with distilled water.

Mix to dissolve. Leave for 30 minutes for the reaction to stabilize. Determine the absorbance at 750 nm through a path length of 1 cm with respect to a blank prepared with distilled water in place of the wine.

If the absorbance is not in the region of 0.3 appropriate dilution should be made.

5.2 *White wine*

Carry out the same procedure with 1 mL of undiluted wine.

6. Expression of results

6.1 *Calculation*

The result is expressed in the form of an index obtained by multiplying the absorbance by 100 for red wines diluted 1/5 (or by the corresponding factor for other dilutions) and by 20 for white wines.

6.2 *Precision*

The difference between the results of two determinations carried out simultaneously or very quickly one after the other by the same analyst must not be greater than 1. Good precision of results is aided by using scrupulously clean apparatus (volumetric flasks and spectrophotometer cells).

Method OIV-MA-AS2-11

Type I method

**Determination of chromatic characteristics
according to CIELab**

(Resolution OENO 1/2006, OIV/OENO 377/2009)

1. Introduction

The colour of a wine is one of the most important visual features available to us, since it provides a considerable amount of highly relevant information.

Colour is a sensation that we perceive visually from the refraction or reflection of light on the surface of objects. Colour is light—as it is strictly related to it—and depending on the type of light (illuminating or luminous stimulus) we see one colour or another. Light is highly variable and so too is colour, to a certain extent.

Wine absorbs a part of the radiations of light that falls and reflects another, which reaches the eyes of the *observer*, making them experience the sensation of colour. For instance, the sensation of very dark red wines is almost entirely due to the fact that incident radiation is absorbed by the wine.

1.1. Scope

The purpose of this spectrophotometric method is to define the process of measuring and calculating the *chromatic characteristics* of wines and other beverages derived from *trichromatic components*: X, Y and Z, according to the *Commission Internationale de l'Eclairage* (CIE, 1976), by attempting to imitate real observers with regard to their sensations of colour.

1.2. Principle and definitions

The colour of a wine can be described using 3 attributes or specific qualities of visual sensation: tonality, luminosity and chromatism.

Tonality—colour itself—is the most characteristic: red, yellow, green or blue. *Luminosity* is the attribute of visual sensation according to which a wine appears to be more or less luminous. However, *chromatism*, or the *level of colouring*, is related to a higher or lower intensity of colour. The combination of these three concepts enables us to define the multiple shades of colour that wines present.

The *chromatic characteristics* of a wine are defined by the *colorimetric* or *chromaticity coordinates* (Fig. 1): *clarity* (L^*), *red/green colour component* (a^*), and *blue/yellow colour component* (b^*); and by its *derived magnitudes*: *chroma* (C^*), *tone* (H^*) and *chromacity* [(a^*, b^*) or (C^*, H^*)]. In other words, this CIELab colour or space system is based on a sequential or continuous Cartesian representation of 3 orthogonal axes: L^* , a^* and b^* (Fig. 2 and 3). Coordinate L^* represents clarity ($L^* = 0$ black and $L^* = 100$ colourless), a^* green/red colour component ($a^* > 0$ red, $a^* < 0$ green) and b^* blue/yellow colour component ($b^* > 0$ yellow, $b^* < 0$ blue).

1.2.1. Clarity

Its symbol is L^* and it is defined according to the following mathematical function:

$$L^* = 116(Y/Y_n)^{1/3} - 16 \quad \text{(I)}$$

Directly related to the visual sensation of luminosity.

1.2.2. Red/green colour component

Its symbol is a^* and it is defined according to the following mathematical function:

$$a^* = 500[(X/X_n) - (Y/Y_n)] \quad \text{(I)}$$

1.2.3. Yellow/blue colour component

Its symbol is b^* and it is defined according to the following mathematical function:

$$b^* = 200 - [(Y/Y_n)^{1/3} - (Z/Z_n)^{1/3}] \quad \text{(I)}$$

1.2.4. Chroma

The chroma symbol is C^* and it is defined according to the following mathematical function:

$$C^* = \sqrt{a^{*2} + b^{*2}}$$

1.2.5. Tone

The tone symbol is H^* , its unit is the sexagesimal degree ($^\circ$), and it is defined according to the following mathematical function:

$$H^* = \text{tg}^{-1} (b^*/a^*)$$

1.2.6. Difference of tone between two wines

The symbol is ΔH^* and it is defined according to the following mathematical function:

$$\Delta H^* = \sqrt{(\Delta E^*)^2 - (\Delta L^*)^2 - (\Delta C^*)^2}$$

(I) See explanation Annex I

1.2.7. Overall colorimetric difference between two wines

The symbol is ΔE^* and it is defined according to the following mathematical functions:

$$\Delta E^* = \sqrt{(\Delta L^*)^2 + (\Delta a^*)^2 + (\Delta b^*)^2} = \sqrt{(\Delta L^*)^2 + (\Delta C^*)^2}$$

1.3. Reagents and products

Distilled water.

1.4. Apparatus and equipment

Customary laboratory apparatus and, in particular, the following:

- 1.4.1. Spectrophotometer to carry out transmittance measurements at a wavelength of between 300 and 800 nm, with illuminant D65 and observer placed at 10°. Use apparatus with a resolution equal to or higher than 5 nm and, where possible, with scan.
- 1.4.2. Computer equipment and suitable programme which, when connected to the spectrophotometer, will facilitate calculating colorimetric coordinates (L^* , a^* and b^*) and their derived magnitudes (C^* and H^*).
- 1.4.3. Glass cuvettes, available in pairs, optical thickness 1, 2 and 10 mm.
- 1.4.4. Micropipettes for volumes between 0.020 and 2 ml.

1.5. Sampling and sample preparation

Sample taking must particularly respect all concepts of homogeneity and representativity.

If the wine is dull, it must be clarified by centrifugation. For young or sparkling wines, as much carbon dioxide as possible must be eliminated by vacuum stirring or using a sonicator.

1.6. Procedure

- Select the pair of cuvettes for the spectrophotometric reading, ensuring that the upper measurement limit within the linear range of the spectrophotometer is not exceeded. By way of indication, for white and rosé wines it is recommended to use cuvettes with 10 mm of optical thickness, and for red wines, cuvettes with 1 mm optical thickness.
- After obtaining and preparing the sample, measure its transmittance from 380 to 780 nm every 5 nm, using distilled water as a reference in a cuvette with the same optical thickness, in order to establish the base line or the white line. Choose illuminant D65 and observer 10°.
- If the optical thickness of the reading cuvette is under 10 mm, the transmittance must be transformed to 10 mm before calculating: L^* , a^* , b^* , C^* and H^* .
Summary:

**COMPENDIUM OF INTERNATIONAL ANALYSIS OF METHODS - OIV
Chromatic Characteristics**

Spectral measurements in transmittance from 780 to 380 nm
Interval: 5 nm
Cuvettes: use appropriately according to wine intensity: 1 cm (white and rosé wines) and 0.1 cm (red wines)
Illuminant D65
Observer reference pattern 10°

1.7. Calculations

The spectrophotometer must be connected to a computer programme to facilitate the calculation of the colorimetric coordinates (L^* , a^* and b^*) and their derived magnitudes (C^* and H^*), using the appropriate mathematical algorithms.

In the event of a computer programme not being available, see Annex I on how to proceed.

1.8. Expression of results

The colorimetric coordinates of wine will be expressed according to the recommendations in the following table.

Colorimetric coordinates	Symbol	Unit	Interval	Decimals
Clarity	L^*		0-100 0 black 100 colourless	1
Red/green colour component	a^*		>0 red <0 green	2
Yellow/blue colour component	b^*		>0 yellow <0 blue	2
Chroma	C^*			2
Tone	H^*	°	0-360°	2

1.9. Numerical Example

Figure 4 shows the values of the colorimetric coordinates and the chromaticity diagram of a young red wine for the following values:

$X = 12.31$; $Y = 60.03$ and $Z = 10.24$

$L^* = 29.2$

$a^* = 55.08$

$b^* = 36.10$

$C^* = 66.00$

$H^* = 33.26^\circ$

2. Accuracy

COMPENDIUM OF INTERNATIONAL ANALYSIS OF METHODS - OIV Chromatic Characteristics

The above data were obtained from two interlaboratory tests of 8 samples of wine with blind duplicates of progressive chromatic characteristics, in accordance with the recommendations of the harmonized protocol for collaborative studies, with a view to validating the method of analysis.

2.1. Colorimetric coordinate L* (clarity, 0-100)

Sample Identification	A	B	C	D	E	F	G	H
Year of interlaboratory test	2004	2002	2004	2004	2004	2004	2002	2004
No. of participating laboratories	18	21	18	18	17	18	23	18
No. of laboratories accepted after aberrant value elimination	14	16	16	16	14	17	21	16
Mean value (\bar{X})	96.8	98.0	91.6	86.0	77.4	67.0	34.6	17.6
Repeatability standard deviation (s_r)	0.2	0.1	0.2	0.8	0.2	0.9	0.1	0.2
Relative repeatability standard deviation (RSD_r) (%)	0.2	0.1	0.3	1.0	0.3	1.3	0.2	1.2
Repeatability limit (r) ($2.8 \times s_r$)	0.5	0.2	0.7	2.2	0.7	2.5	0.2	0.6
Reproducibility standard deviation (s_R)	0.6	0.1	1.2	2.0	0.8	4.1	1.0	1.0
Relative reproducibility standard deviation (RSD_R) (%)	0.6	0.1	1.3	2.3	1.0	6.1	2.9	5.6
Reproducibility limit (R) ($2.8 \times s_R$)	1.7	0.4	3.3	5.5	2.2	11.5	2.8	2.8

**COMPENDIUM OF INTERNATIONAL ANALYSIS OF METHODS - OIV
Chromatic Characteristics**

2.2. Colorimetric coordinate a* (green/red)

Sample Identification	A	B	C	D	E	F	G	H
Year of interlaboratory	2004	2002	2004	2004	2004	2004	2002	2004
No. of participating laboratories	18	21	18	18	17	18	23	18
No. of laboratories accepted after aberrant value elimination	15	15	14	15	13	16	23	17
Mean value (\bar{X})	-0.26	-0.86	2.99	11.11	20.51	29.29	52.13	47.55
Repeatability standard deviation (s_r)	0.17	0.01	0.04	0.22	0.25	0.26	0.10	0.53
Relative repeatability standard deviation (RSD_r) (%)	66.3	1.4	1.3	2.0	1.2	0.9	0.2	1.1
Repeatability limit (r) ($2.8 \times s_r$)	0.49	0.03	0.11	0.61	0.71	0.72	0.29	1.49
Reproducibility standard deviation (s_R)	0.30	0.06	0.28	0.52	0.45	0.98	0.88	1.20
Relative reproducibility standard deviation (RSD_R) (%)	116.0	7.5	9.4	4.7	2.2	3.4	1.7	2.5
Reproducibility limit (R) ($2.8 \times s_R$)	0.85	0.18	0.79	1.45	1.27	2.75	2.47	3.37

2.3. Colorimetric coordinate b* (blue/yellow)

Sample Identification	A	B	C	D	E	F	G	H
Year of interlaboratory	2004	2002	2004	2004	2004	2004	2002	2004
No. of participating laboratories	17	21	17	17	17	18	23	18
No. of laboratories accepted after aberrant value elimination	15	16	13	14	16	18	23	15
Mean value (\bar{X})	10.9 5	9.04	17.7 5	17.1 0	19.6 8	26.5 1	45.8 2	30.0 7
Repeatability standard deviation (s_r)	0.25	0.03	0.08	1.08	0.76	0.65	0.15	0.36
Relative repeatability standard deviation (RSD_r) (%)	2.3	0.4	0.4	6.3	3.8	2.5	0.3	1.2
Repeatability limit (r) ($2.8 \times s_r$)	0.71	0.09	0.21	3.02	2.12	1.83	0.42	1.01
Reproducibility standard deviation (s_R)	0.79	0.19	0.53	1.18	3.34	2.40	1.44	1.56
Relative reproducibility standard deviation (RSD_R) (%)	7.2	2.1	3.0	6.9	16.9	9.1	3.1	5.2
Reproducibility limit (R) ($2.8 \times s_R$)	2.22	0.53	1.47	3.31	9.34	6.72	4.03	4.38

BIBLIOGRAPHY

- Vocabulaire International de l'Éclairage. Publication CIE 17.4.- Publication I.E.C. 50(845). CEI(1987). Genève. Suisse.
- Colorimetry, 2nd Ed.- Publication CIE 15.2 (1986) Vienna.
- Colorimetry, 2nd Ed.- Publication CIE 15.2 (1986) Vienna.
- Kowaliski P. – Vision et mesure de la couleur. Masson ed. Paris 1990
- Wiszecki G. And W.S.Stiles, Color Science, Concepts and Methods, Quantitative Data and Formulae, 2nd Ed. Wiley, New York 1982
- Sève R. - Physique de la couleur. Masson. Paris (1996)
- Echávarri J.F., Ayala F. et Negueruela A.I. -Influence du pas de mesure dans le calcul des coordonnées de couleur du vin. Bulletin de l'OIV 831-832, 370-378 (2000)
- I.R.A.N.O.R . Magnitudes Colorimetricas. Norma UNE 72-031-83
- Bertrand A.- Mesure de la couleur. F.V. 1014 2311/190196
- Fernández, J.I.; Carcelén, J.C.; Martínez, A. III Congreso Nacional De Enólogos, 1.997. Características cromáticas de vinos rosados y tintos de la cosecha de 1996 en la region de murcia
- Cagnaso E.- Metodi Oggettivi per la definizione del colore del vino. Quaderni della Scuoladi Specializzazione in Scienze Viticole ed Enologiche. Universidad di Torino. 1997
- Ortega A.P., Garcia M.E., Hidalgo J., Tienda P., Serrano J. – 1995- Identificación y Normalización de los colores del vino. Carta de colores. Acti XXI Congreso Mundial de la Viña y el Vino, Punta del Este. ROU 378-391
- Iñiguez M., Rosales A., Ayala R., Puras P., Ortega A.P.- 1995 - La cata de color y los parametros CIELab, caso de los vinos tintos de Rioja. Acti XXI Congreso Mundial de la Viña y el Vino, Punta del Este.ROU 392-411
- Billmeyer, F.W. jr. and M. Saltzman: Principles of Color. Technology, 2. Auflage, New York; J. Wiley and Sons, 1981.

APPENDIX 1

In formal terms, the trichromatic components X, Y, Z of a colour stimulus result from the integration, throughout the visible range of the spectrum, of the functions

**COMPENDIUM OF INTERNATIONAL ANALYSIS OF METHODS - OIV
Chromatic Characteristics**

obtained by multiplying the relative spectral curve of the colour stimulus by the colorimetric functions of the reference observer. These functions are always obtained by experiment. It is not possible, therefore to calculate the trichromatic components directly by integration. Consequently, the approximate values are determined by replacing these integrals by summations on finished wavelength intervals.

&	$K \int_{(\lambda)} T_{(\lambda)} S_{(\lambda)} \bar{X}_{10(\lambda)} d\lambda$	$T_{(\lambda)}$ is the measurement of the transmittance of the wine measured at the wavelength λ expressed at 1 cm from the optical thickness.
8	$K \int_{(\lambda)} T_{(\lambda)} S_{(\lambda)} \bar{Y}_{10(\lambda)} d\lambda$	$\Delta(\lambda)$ is the interval between the value of λ at which $T_{(\lambda)}$ is measured
=	$K \int_{(\lambda)} T_{(\lambda)} S_{(\lambda)} \bar{Z}_{10(\lambda)} d\lambda$	$S_{(\lambda)}$: coefficients that are a function of λ and of the illuminant (Table 1).
K	$100 / \int_{(\lambda)} S_{(\lambda)} \bar{Y}_{10(\lambda)} d\lambda$	$\bar{X}_{10(\lambda)}$; $\bar{Y}_{10(\lambda)}$; $\bar{Z}_{10(\lambda)}$: coefficients that are a function of λ and of the observer. (Table 1)

The values of X_n , Y_n , and Z_n represent the values of the perfect diffuser under an illuminant and a given reference observer. In this case, the illuminant is D65 and the observer is higher than 4 degrees.

$$X_n = 94.825; \quad Y_n = 100; \quad Z_n = 107.381$$

This roughly uniform space is derived from the space CIEYxy, in which the trichromatic components X, Y, Z are defined.

The coordinates L^* , a^* and b^* are calculated based on the values of the trichromatic components X, Y, Z, using the following formulae.

$$L^* = 116 (Y / Y_n)^{1/3} - 16 \quad \text{where } Y/Y_n > 0.008856$$

$$L^* = 903.3 (Y / Y_n) \quad \text{where } Y / Y_n < 0.008856$$

$$a^* = 500 [f(X / X_n) - f(Y / Y_n)]$$

$$b^* = 200 [f(Y / Y_n) - f(Z / Z_n)]$$

$$f(X / X_n) = (X / X_n)^{1/3} \quad \text{where } (X / X_n) > 0.008856$$

$$f(X / X_n) = 7.787 (X / X_n) + 16 / 116 \quad \text{where } (X / X_n) < 0.008856$$

$$f(Y / Y_n) = (Y / Y_n)^{1/3} \quad \text{where } (Y / Y_n) > 0.008856$$

$$f(Y / Y_n) = 7.787 (Y / Y_n) + 16 / 116 \quad \text{where } (Y / Y_n) < 0.008856$$

$$f(Z / Z_n) = (Z / Z_n)^{1/3} \quad \text{where } (Z / Z_n) > 0.008856$$

$$f(Z / Z_n) = 7.787 (Z / Z_n) + 16 / 116 \quad \text{where } (Z / Z_n) < 0.008856$$

The total colorimetric difference between two colours is given by the CIELAB colour difference

$$\Delta E^* = [(\Delta L^*)^2 + (\Delta a^*)^2 + (\Delta b^*)^2]^{1/2}$$

In the CIELAB space it is possible to express not only overall variations in colour, but also in relation to one or more of the parameters L^* , a^* and b^* . This can be used to define new parameters and to relate them to the attributes of the visual sensation.

Clarity, related to luminosity, is directly represented by the value of L^* .

Chroma: $C^* = (a^{*2} + b^{*2})^{1/2}$ defines the chromaticness.

The angle of hue: $H^* = \text{tg}^{-1}(b^*/a^*)$ (expressed in degrees); related to hue.

The difference in hue: $\Delta H^* = [(\Delta E^*)^2 - (\Delta L^*)^2 - (\Delta C^*)^2]^{1/2}$

For two unspecified colours, ΔC^* represents their difference in chroma; ΔL^* , their difference in clarity, and ΔE^* , their overall variation in colour. We thus have:

$$\Delta E^* = [(\Delta L^*)^2 + (\Delta a^*)^2 + (\Delta b^*)^2]^{1/2} = [(\Delta L^*)^2 + (\Delta C^*)^2 + (\Delta H^*)^2]^{1/2}$$

**COMPENDIUM OF INTERNATIONAL ANALYSIS OF METHODS - OIV
Chromatic Characteristics**

Table 1.

Wavelength (λ) nm.	S_{λ}	$\bar{x}_{10(\lambda)}$	$\bar{y}_{10(\lambda)}$	$\bar{z}_{10(\lambda)}$
380	50.0	0.0002	0.0000	0.0007
385	52.3	0.0007	0.0001	0.0029
390	54.6	0.0024	0.0003	0.0105
395	68.7	0.0072	0.0008	0.0323
400	82.8	0.0191	0.0020	0.0860
405	87.1	0.0434	0.0045	0.1971
410	91.5	0.0847	0.0088	0.3894
415	92.5	0.1406	0.0145	0.6568
420	93.4	0.2045	0.0214	0.9725
425	90.1	0.2647	0.0295	1.2825
430	86.7	0.3147	0.0387	1.5535
435	95.8	0.3577	0.0496	1.7985
440	104.9	0.3837	0.0621	1.9673
445	110.9	0.3867	0.0747	2.0273
450	117.0	0.3707	0.0895	1.9948
455	117.4	0.3430	0.1063	1.9007
460	117.8	0.3023	0.1282	1.7454
465	116.3	0.2541	0.1528	1.5549
470	114.9	0.1956	0.1852	1.3176
475	115.4	0.1323	0.2199	1.0302
480	115.9	0.0805	0.2536	0.7721
485	112.4	0.0411	0.2977	0.5701
490	108.8	0.0162	0.3391	0.4153
495	109.1	0.0051	0.3954	0.3024
500	109.4	0.0038	0.4608	0.2185
505	108.6	0.0154	0.5314	0.1592
510	107.8	0.0375	0.6067	0.1120
515	106.3	0.0714	0.6857	0.0822
520	104.8	0.1177	0.7618	0.0607
525	106.2	0.1730	0.8233	0.0431
530	107.7	0.2365	0.8752	0.0305
535	106.0	0.3042	0.9238	0.0206
540	104.4	0.3768	0.9620	0.0137
545	104.2	0.4516	0.9822	0.0079
550	104.0	0.5298	0.9918	0.0040
555	102.0	0.6161	0.9991	0.0011
560	100.0	0.7052	0.9973	0.0000
565	98.2	0.7938	0.9824	0.0000
570	96.3	0.8787	0.9556	0.0000

**COMPENDIUM OF INTERNATIONAL ANALYSIS OF METHODS - OIV
Chromatic Characteristics**

575	96.1	0.9512	0.9152	0.0000
580	95.8	1.0142	0.8689	0.0000
585	92.2	1.0743	0.8256	0.0000
590	88.7	1.1185	0.7774	0.0000
595	89.3	1.1343	0.7204	0.0000
600	90.0	1.1240	0.6583	0.0000
605	89.8	1.0891	0.5939	0.0000
610	89.6	1.0305	0.5280	0.0000
615	88.6	0.9507	0.4618	0.0000
620	87.7	0.8563	0.3981	0.0000
625	85.5	0.7549	0.3396	0.0000
630	83.3	0.6475	0.2835	0.0000
635	83.5	0.5351	0.2283	0.0000
640	83.7	0.4316	0.1798	0.0000
645	81.9	0.3437	0.1402	0.0000
650	80.0	0.2683	0.1076	0.0000
655	80.1	0.2043	0.0812	0.0000
660	80.2	0.1526	0.0603	0.0000
665	81.2	0.1122	0.0441	0.0000
670	82.3	0.0813	0.0318	0.0000
675	80.3	0.0579	0.0226	0.0000
680	78.3	0.0409	0.0159	0.0000
685	74.0	0.0286	0.0111	0.0000
690	69.7	0.0199	0.0077	0.0000
695	70.7	0.0138	0.0054	0.0000
700	71.6	0.0096	0.0037	0.0000
705	73.0	0.0066	0.0026	0.0000
710	74.3	0.0046	0.0018	0.0000
715	68.0	0.0031	0.0012	0.0000
720	61.6	0.0022	0.0008	0.0000
725	65.7	0.0015	0.0006	0.0000
730	69.9	0.0010	0.0004	0.0000
735	72.5	0.0007	0.0003	0.0000
740	75.1	0.0005	0.0002	0.0000
745	69.3	0.0004	0.0001	0.0000
750	63.6	0.0003	0.0001	0.0000
755	55.0	0.0002	0.0001	0.0000
760	46.4	0.0001	0.0000	0.0000
765	56.6	0.0001	0.0000	0.0000
770	66.8	0.0001	0.0000	0.0000
775	65.1	0.0000	0.0000	0.0000
780	63.4	0.0000	0.0000	0.0000

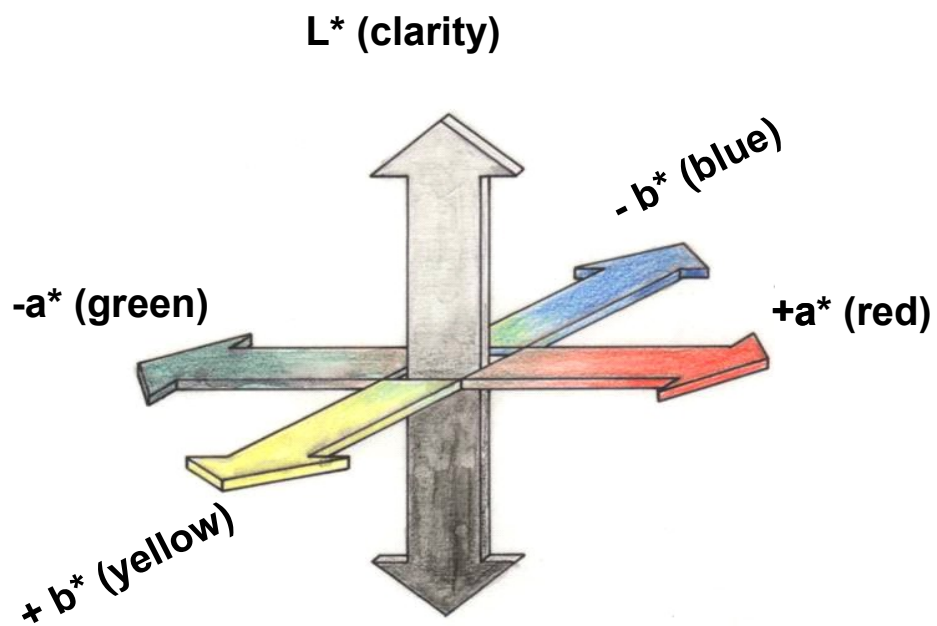

Figure 1. Diagram of colourimetric coordinates according to *Commission Internationale de l'Eclairage* (CIE, 1976)

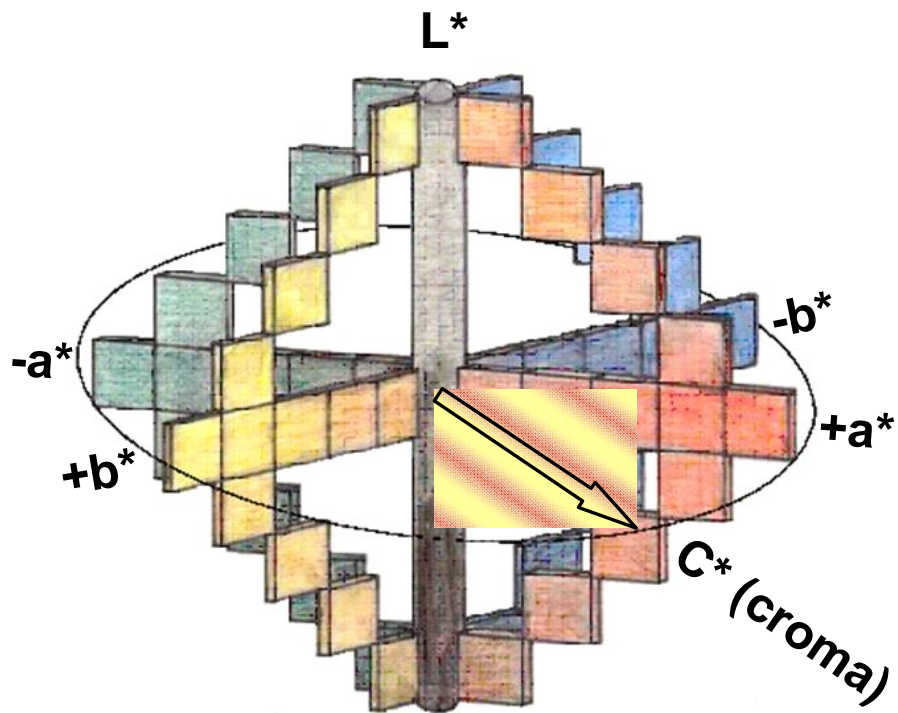

Figure 2. CIE Lab colourspace, based on a sequential or 3 orthogonal axis continual Cartesian representation L^* , a^* y b^*

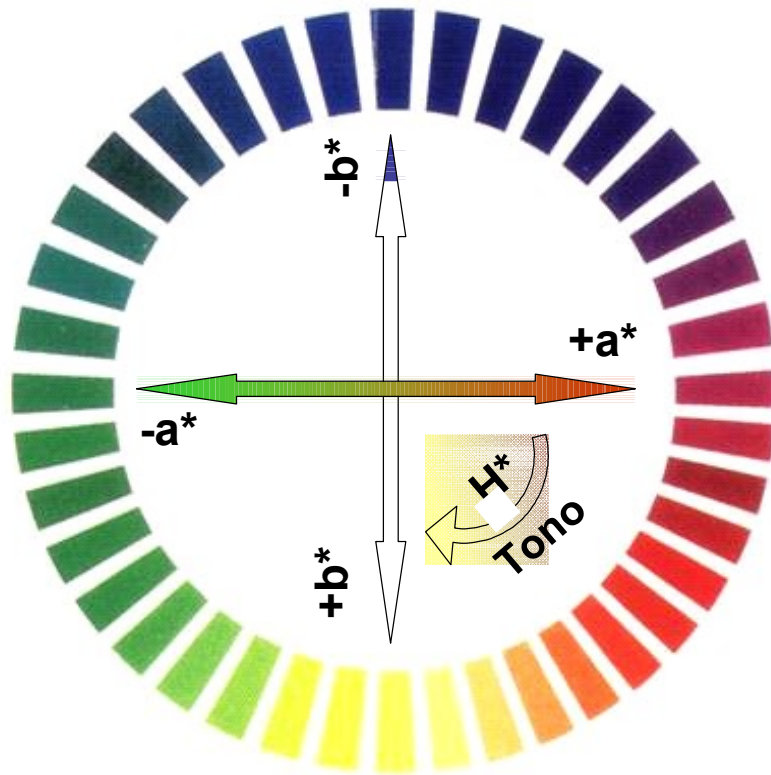
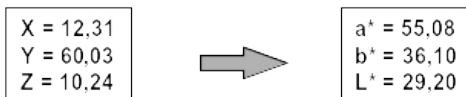

Figure 3. Sequential diagram and/or continuation of a and b colourimetric coordinates and derived magnitude, such as tone (H^*)

Example: Young Red Wine

□ **OBTENTION OF ANALYTICAL PARAMETERS:**

1. Tristimulus Values 2.-Coordinates CIELab



□ **GRAPHIC REPRESENTATION AND ARTICULATION OF RESULTS:**

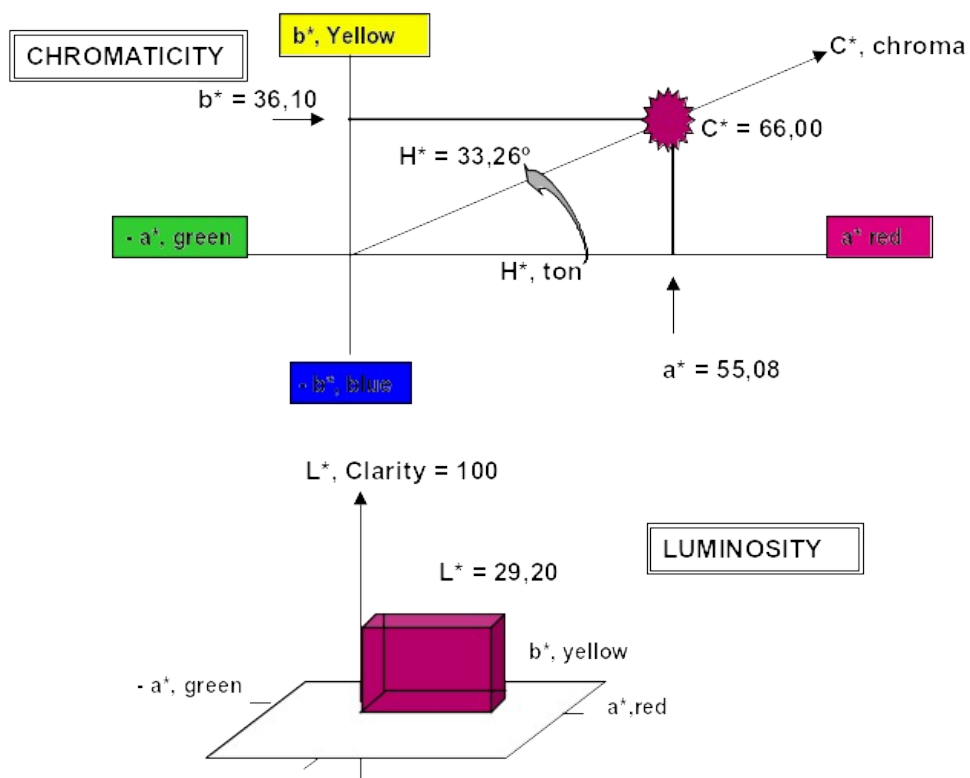

Figure 4. Representation of colour of young red wine used as an example in Chapter 1.8 shown in the CIELab three dimensional diagram.

Method for $^{18}\text{O}/^{16}\text{O}$ isotope ratio determination

of water in wines and must

(Resolution OIV/OENO 353/2009)

1. SCOPE

The method describes the determination of the $^{18}\text{O}/^{16}\text{O}$ isotope ratio of water from wine and must after equilibration with CO_2 , using the isotope ratio mass spectrometry (IRMS).

2. REFERENCE STANDARDS

ISO 5725:1994: Accuracy (trueness and precision) of measurement methods and results: Basic method for the determination of repeatability and reproducibility of a standard measurement method.

V-SMOW: Vienna-Standard Mean Ocean Water ($^{18}\text{O}/^{16}\text{O} = R_{\text{V-SMOW}} = 0.0020052$)

GISP Greenland Ice Sheet Precipitation

SLAP Standard Light Antarctic Precipitation

3. DEFINITIONS

$^{18}\text{O}/^{16}\text{O}$ Isotope ratio of oxygen 18 to oxygen 16 for a given sample

$\delta^{18}\text{O}_{\text{V-SMOW}}$ Relative scale for the expression of the isotope ratio of oxygen 18 to oxygen 16 for a given sample. $\delta^{18}\text{O}_{\text{V-SMOW}}$ is calculated using the following equation:

$$\delta^{18}\text{O}_{\text{V-SMOW}} = \left[\frac{\left(\frac{^{18}\text{O}}{^{16}\text{O}} \right)_{\text{sample}} - \left(\frac{^{18}\text{O}}{^{16}\text{O}} \right)_{\text{standard}}}{\left(\frac{^{18}\text{O}}{^{16}\text{O}} \right)_{\text{standard}}} \right] \times 1000 \text{ [‰]}$$

**COMPENDIUM OF INTERNATIONAL METHODS OF ANALYSIS -
OIV
Isotopic ratio of water**

using the V-SMOW as standard and as reference point for the relative δ scale.

BCR	Community Bureau of Reference
IAEA	International Atomic Energy Agency (Vienna, Austria)
IRMM	Institute for Reference Materials and Measurements
IRMS	Isotope Ratio Mass Spectrometry
m/z	mass to charge ratio
NIST	National Institute of Standards & Technology
RM	Reference Material

4. PRINCIPLE

The technique described thereafter is based on the isotopic equilibration of water in samples of wine or must with a CO₂ standard gas according to the following isotopic exchange reaction:

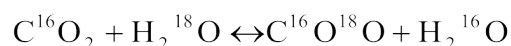

After equilibration the carbon dioxide in the gaseous phase is used for analysis by means of Isotopic Ratio Mass Spectrometry (IRMS) where the ¹⁸O/¹⁶O isotopic ratio is determined on the CO₂ resulting from the equilibration.

5. REAGENTS AND MATERIALS

The materials and consumables depend on the method used (see chapter 6). The systems generally used are based on the equilibration of water in wine or must with CO₂.

The following reference materials, working standards and consumables can be used:

5.1 Reference materials

Name	issued by	$\delta^{18}\text{O}$ versus V-SMOW
V-SMOW, RM 8535	IAEA / NIST	0 ‰
BCR-659	IRMM	-7.18 ‰
GISP, RM 8536	IAEA / NIST	-24.78 ‰
SLAP, RM 8537	IAEA / NIST	-55.5 ‰

5.2 Working Standards

5.2.1 Carbon dioxide as a secondary reference gas for measurement (CAS 00124-38-9).

5.2.2 Carbon dioxide used for equilibration (depending on the instrument this gas could be the same as 5.2.1 or in the case of continuous flow systems cylinders containing gas mixture helium-carbon dioxide can also be used)

5.2.3 Working Standards with calibrated $\delta^{18}\text{O}_{\text{V-SMOW}}$ values traceable to international reference materials.

5.3 Consumables

Helium for analysis (CAS 07440-59-7)

6. APPARATUS

6.1 Isotope ratio mass spectrometry (IRMS)

The Isotope ratio mass spectrometer (IRMS) enables the determination of the relative contents of ^{18}O of CO_2 gas naturally occurring with an internal accuracy of 0.05‰. Internal accuracy here is defined as the difference between 2 measurements of the same sample of CO_2 .

The mass spectrometer used for the determination of the isotopic composition of CO_2 gas is generally equipped with a triple collector to simultaneously measure the following ion currents:

- $m/z = 44$ ($^{12}\text{C}^{16}\text{O}^{16}\text{O}$)
- $m/z = 45$ ($^{13}\text{C}^{16}\text{O}^{16}\text{O}$ and $^{12}\text{C}^{17}\text{O}^{16}\text{O}$)
- $m/z = 46$ ($^{12}\text{C}^{16}\text{O}^{18}\text{O}$, $^{12}\text{C}^{17}\text{O}^{17}\text{O}$ and $^{13}\text{C}^{17}\text{O}^{16}\text{O}$)

By measuring the corresponding intensities, the $^{18}\text{O}/^{16}\text{O}$ isotopic ratio is determined from the ratio of intensities of $m/z = 46$ and $m/z = 44$ after corrections for isobaric species ($^{12}\text{C}^{17}\text{O}^{17}\text{O}$ and $^{13}\text{C}^{17}\text{O}^{16}\text{O}$) whose contributions can be calculated from the actual intensity observed for $m/z = 45$ and the usual isotopic abundances for ^{13}C and ^{17}O in Nature.

The isotope ratio mass spectrometry must either be equipped with:

- a double introduction system (dual inlet system) to alternately measure the unknown sample and a reference standard.
- or a continuous flow system that transfers quantitatively the CO_2 from the sample vials after equilibration but also the CO_2 standard gas into the mass spectrometer.

**COMPENDIUM OF INTERNATIONAL METHODS OF ANALYSIS -
OIV
Isotopic ratio of water**

6.2 Equipment and Materials

All equipments and materials used must meet stated requirements of the used method / apparatus (as specified by the manufacturer). However, all equipments and materials can be replaced by items with similar performance.

6.2.1 Vials with septa appropriate for the used system

6.2.2 Volumetric pipettes with appropriate tips

6.2.3 Temperature controlled system to carry out the equilibration at constant temperature, typically within ± 1 °C

6.2.4 Vacuum pump (if needed for the used system)

6.2.5 Autosampler (if needed for the used system)

6.2.6 Syringes for sampling (if needed for the used system)

6.2.7 GC Column to separate CO₂ from other elementary gases (if needed for the used system)

6.2.8 Water removal device (e.g. cryo-trap, selective permeable membranes)

7. SAMPLING

Wine and must samples as well as reference materials are used for analysis without any pre-treatment. In the case of the possible fermentation of the sample, benzoic acid (or another anti-fermentation product) should be added or filtered with a with a 0,22 µm pore diameter filter.

Preferably, the reference materials used for calibration and drift-correction should be placed at the beginning and at the end of the sequence and inserted after every ten samples.

8. PROCEDURE

The descriptions that follow refer to procedures generally used for the determination of the ¹⁸O/¹⁶O isotopic ratios by means of equilibration of water with a CO₂ working standard and the subsequent measurement by IRMS. These procedures can be altered according to changes of equipment and instrumentation provided by the manufacturers as various kind of equilibration devices are available, implying various conditions of operation. Two main technical procedures can be used for introduction of CO₂ into the IRMS either through a dual inlet system or using a continuous flow system. The description of all these technical systems and of the corresponding conditions of operation is not possible. Note: all values given for volumes, temperatures, pressures and time periods are

**COMPENDIUM OF INTERNATIONAL METHODS OF ANALYSIS -
OIV
Isotopic ratio of water**

only indicative. Appropriate values must be obtained from specifications provided by the manufacturer and/or determined experimentally.

8.1 Manual equilibration

A defined volume of the sample/standard is transferred into a flask using a pipette. The flask is then attached tightly to the manifold.

Each manifold is cooled down to below $-80\text{ }^{\circ}\text{C}$ to deep-freeze the samples (manifold equipped with capillary opening tubes do not require this freezing step). Subsequently, the whole system is evacuated. After reaching a stable vacuum the gaseous CO_2 working standard is allowed to expand into the various flasks. For the equilibration process each manifold is placed in a temperature controlled water-bath typically at 25°C ($\pm 1\text{ }^{\circ}\text{C}$) for 12 hours (overnight). It is crucial that the temperature of the water-bath is kept constant and homogeneous.

After the equilibration process is completed, the resulting CO_2 is transferred from the flasks to the sample side bellow of the dual inlet system. The measurements are performed by comparing several times the ratios of the CO_2 contained in the sample side and the standard side (CO_2 reference standard gas) of the dual inlet. This approach is repeated till the last sample of the sequence has been measured.

8.2 Use of an automatic equilibration apparatus

A defined volume of the sample/standard is transferred into a vial using a pipette. The sample vials are attached to the equilibration system and cooled down to below $-80\text{ }^{\circ}\text{C}$ to deep-freeze the samples (systems equipped with capillary opening tubes do not require this freezing step). Subsequently, the whole system is evacuated.

After reaching a stable vacuum the gaseous CO_2 working standard is expanded into the vials. Equilibrium is reached at a temperature of typically $22 \pm 1\text{ }^{\circ}\text{C}$ after a minimum period of 5 hours and with moderate agitation (if available). Since the equilibration duration depends on various parameters (e.g. the vial geometry, temperature, applied agitation ...), the minimum equilibrium time should be determined experimentally.

After the equilibration process is completed, the resulting CO_2 is transferred from the vials to the sample side bellow of the dual inlet system. The measurements are performed by comparing several times the ratios of the CO_2 contained in the sample side and the standard side (CO_2 reference standard gas) of the dual inlet. This approach is repeated till the last sample of the sequence has been measured.

8.3 Manual preparation manual and automatic equilibration and analysis with a dual inlet IRMS

A defined volume of sample / standard (eg. 200 μL) is introduced into a vial using a pipette. The open vials are then placed in a closed chamber filled with the CO_2 used for equilibration (5.2.2). After several purges to eliminate any trace of air, the vials are closed and then placed on the thermostated plate of the sample changer. The equilibration is reached after at least 8 hours at 40 $^\circ\text{C}$. Once the process of equilibration completed, the CO_2 obtained is dried and then transferred into the sample side of the dual inlet introduction system. The measurements are performed by comparing several times the ratios of the CO_2 contained in the sample side and the standard side (CO_2 reference standard gas) of the dual inlet. This approach is repeated till the last sample of the sequence has been measured.

8.4 Use of an automatic equilibration apparatus coupled to a continuous flow system

A defined volume of the sample/standard is transferred into a vial using a pipette. The sample vials are placed into a temperature controlled tray. Using a gas syringe the vials are flushed with mixture of He and CO_2 . The CO_2 remains in the headspace of the vials for equilibration. Equilibrium is reached at a temperature typically of 30 ± 1 $^\circ\text{C}$ after a minimum period of 18 hours.

After the equilibration process is completed the resulting CO_2 is transferred by means of the continuous flow system into the ion source of the mass spectrometer. CO_2 reference gas is also introduced into the IRMS by means of the continuous flow system. The measurement is carried out according to a specific protocol for each kind of equipment.

9. CALCULATION

The intensities for $m/z = 44, 45, 46$ are recorded for each sample and reference materials analysed in a batch of measurements. The $^{18}\text{O}/^{16}\text{O}$ isotope ratios are then calculated by the computer and the software of the IRMS instrument according to the principles explained in section 6.1. In practice the $^{18}\text{O}/^{16}\text{O}$ isotope ratios are measured against a working standard previously calibrated against the V-SMOW. Small variations may occur while measuring on line due to changes in the instrumental conditions. In such a case the $\delta^{18}\text{O}$ of the samples must be corrected

**COMPENDIUM OF INTERNATIONAL METHODS OF ANALYSIS -
OIV
Isotopic ratio of water**

according to the difference in the $\delta^{18}\text{O}$ value from the working standard and its assigned value, which was calibrated beforehand against V-SMOW. Between two

measurements of the working standard, the variation is the correction applied to the sample results that may be assumed to be linear. Indeed, the working standard must be measured at the beginning and at the end of all sample series. Therefore a correction can be calculated for each sample using linear interpolation between two values (the difference between the assigned value of the working standard and the measurements of the obtained values).

The final results are presented as relative $\delta^{18}\text{O}_{\text{V-SMOW}}$ values expressed in ‰. $\delta^{18}\text{O}_{\text{V-SMOW}}$ values are calculated using the following equation:

$$\delta^{18}\text{O}_{\text{V-SMOW}} = \left[\frac{\left(\frac{^{18}\text{O}}{^{16}\text{O}} \right)_{\text{sample}} - \left(\frac{^{18}\text{O}}{^{16}\text{O}} \right)_{\text{V-SMOW}}}{\left(\frac{^{18}\text{O}}{^{16}\text{O}} \right)_{\text{V-SMOW}}} \right] \times 1000 \text{ [‰]}$$

The $\delta^{18}\text{O}$ value normalized versus the V-SMOW/SLAP scale is calculated using the following equation:

$$\delta^{18}\text{O}_{\text{V-SMOW/SLAP}} = \left[\frac{\delta^{18}\text{O}_{\text{sample}} - \delta^{18}\text{O}_{\text{V-SMOW}}}{\delta^{18}\text{O}_{\text{V-SMOW}} - \delta^{18}\text{O}_{\text{SLAP}}} \right] \times 55.5 \text{ [‰]}$$

The $\delta^{18}\text{O}_{\text{V-SMOW}}$ value accepted for SLAP is -55.5‰ (see also 5.1).

10. PRECISION

The repeatability (r) is equal to 0.24 ‰.

The reproducibility (R) is equal to 0.50 ‰.

**COMPENDIUM OF INTERNATIONAL METHODS OF ANALYSIS -
OIV
Isotopic ratio of water**

Summary of statistical results

	General average (‰)	Standard deviation of repeatability (‰) s_r	Repeatability (‰) r	Standard deviation of reproducibility (‰) s_R	Reproducibility (‰) R
Water					
Sample 1	-8.20	0.068	0.19	0.171	0.48
Sample 2	-8.22	0.096	0.27	0.136	0.38
Wine N° 1					
Sample 5	6.87	0.098	0.27	0.220	0.62
Sample 8	6.02	0.074	0.21	0.167	0.47
Sample 9	5.19	0.094	0.26	0.194	0.54
Sample 4	3.59	0.106	0.30	0.205	0.57
Wine N° 2					
Sample 3	-1.54	0.065	0.18	0.165	0.46
Sample 6	-1.79	0.078	0.22	0.141	0.40
Sample 7	-2.04	0.089	0.25	0.173	0.49
Sample 10	-2.61	0.103	0.29	0.200	0.56

11. INTER-LABORATORIES STUDIES

Bulletin de l'O.I.V. janvier-février 1997, 791-792, p.53 - 65.

**COMPENDIUM OF INTERNATIONAL METHODS OF ANALYSIS -
OIV
Isotopic ratio of water**

12. BIBLIOGRAPHY

- [1] Allison, C.E., Francey, R.J. and Meijer., H.A., (1995) Recommendations for the Reporting of Stable Isotopes Measurements of carbon and oxygen. Proceedings of a consultants meeting held in Vienna, 1 - 3. Dec. 1993, *IAEA-TECDOC-825*, 155-162, Vienna, Austria.
- [2] Baertschi, P., (1976) Absolute ^{18}O Content of Standard Mean Ocean Water. *Earth and Planetary Science Letters*, 31, 341-344.
- [3] Breas, O., Reniero, F. and Serrini, G., (1994) Isotope Ratio Mass Spectrometry: Analysis of wines from different European Countries. *Rap. Comm. Mass Spectrom.*, 8, 967-987.
- [4] Craig, H., (1957) Isotopic standards for carbon and oxygen and correction factors for mass spectrometric analysis of carbon dioxide. *Geochim. Cosmochim. Acta*, 12, 133-149.
- [5] Craig, H., (1961) Isotopic Variations in Meteoric Waters. *Science*, 133, 1702-1703.
- [6] Craig, H., (1961) Standard for reporting concentrations of deuterium and oxygen-18 in natural waters. *Science*, 133, 1833-1834.
- [7] Coplen, T., (1988) Normalization of oxygen and hydrogen data. *Chemical Geology (Isotope Geoscience Section)*, 72, 293-297
- [8] Coplen, T. and Hopple, J., (1995) Audit of V-SMOW distributed by the US National Institute of Standards and Technology. Proceedings of a consultants meeting held in Vienna, 1 - 3. Dec. 1993, *IAEA-TECDOC-825*, 35-38 IAEA, Vienna, Austria.
- [9] Dunbar, J., (1982) Detection of added water and sugar in New Zealand commercial wines. Elsevier Scientific Publishing Corp. Edts. Amsterdam, 1495-501.
- [10] Epstein, S. and Mayeda, T. (1953) Variations of the $^{18}\text{O}/^{16}\text{O}$ ratio in natural waters. *Geochim. Cosmochim. Acta*, 4, 213 .
- [11] Förstel, H. (1992) Projet de description d'une méthode : variation naturelle du rapport des isotopes ^{16}O et ^{18}O dans l'eau comme méthode d'analyse physique du vin en vue du contrôle de l'origine et de l'addition d'eau. *OIV, FV n° 919*, 1955/220792.
- [12] Gonfiantini, R., (1978) Standards for stable isotope measurements in natural compounds. *Nature*, 271, 534-536.
- [13] Gonfiantini, R., (1987) Report on an advisory group meeting on stable isotope reference samples for geochemical and hydrochemical investigations. IAEA, Vienna, Austria.
- [14] Gonfiantini, R., Stichler, W. and Rozanski, K., (1995) Standards and Intercomparison Materials distributed by the IAEA for Stable Isotopes Measurements. Proceedings of a consultants meeting held in Vienna, 1 - 3. Dec. 1993, *IAEA-TECDOC-825*, 13-29 Vienna, Austria.

**COMPENDIUM OF INTERNATIONAL METHODS OF ANALYSIS -
OIV
Isotopic ratio of water**

- [15] Guidelines for Collaborative Study Procedures (1989) *J. Assoc. Off. Anal. Chem.*, 72, 694-704.
- [16] Martin, G.J., Zhang, B.L., Day, M. and Lees, M., (1993) Authentification des vins et des produits de la vigne par utilisation conjointe des analyses élémentaire et isotopique. *OIV, F.V.*, n°917, 1953/220792.
- [17] Martin, G.J., Förstel, H. and Moussa, I. (1995) La recherche du mouillage des vins par analyse isotopique ^2H et ^{18}O . *OIV, FV n° 1006*, 2268/240595
- [18] Martin, G.J. (1996) Recherche du mouillage des vins par la mesure de la teneur en ^{18}O de l'eau des vins. *OIV, FV n° 1018*, 2325/300196.
- [19] Martin, G.J. and Lees, M., (1997) Détection de l'enrichissement des vins par concentration des moûts au moyen de l'analyse isotopique ^2H et ^{18}O de l'eau des vins. *OIV, FV n° 1019*, 2326/300196.
- [20] Moussa, I., (1992) Recherche du mouillage dans les vins par spectrométrie de masse des rapports isotopiques (SMRI). *OIV, FV n°915*, 1937/130592.
- [21] Werner, R.A. and Brand, W., (2001) Reference Strategies and techniques in stable isotope ratio analysis. *Rap. Comm. Mass Spectrom.*, 15, 501-519.
- [22] Zhang, B.L., Fourel, F., Naulet, N. and Martin, G.J., (1992) Influence de l'expérimentation et du traitement de l'échantillon sur la précision et la justesse des mesures des rapports isotopiques (D/H) et ($^{18}\text{O}/^{16}\text{O}$). *OIV, F.V. n° 918*, 1954/220792.

Reducing substances

(Resolution OIV/OENO 377/2009)

1. Definition

Reducing substances comprise all the sugars exhibiting ketonic and aldehydic functions and are determined by their reducing action on an alkaline solution of a copper salt.

2. Principle of the method

Clarification

The wine is treated with one of the following reagents:

- neutral lead acetate,
- zinc ferrocyanide (II).

3. Clarification

The sugar content of the liquid in which sugar is to be determined must lie between 0.5 and 5 g/L.

Dry wines should not be diluted during clarification; sweet wines should be diluted during clarification in order to bring the sugar level to within the limits prescribed in the following table.

Description	Sugar content (g/L)	Density	Dilution (%)
Musts and mistelles	> 125	> 1.038	1
Sweet wines, whether	25 to 125	1.005 to	4
Semi-sweet wines	5 to 25	0.997 to	20
Dry wines	< 5	< 0.997	No dilution

3.1. Clarification by neutral lead acetate.

3.1.1. Reagents

- Neutral lead acetate solution (approximately saturated)

Neutral lead acetate, $\text{Pb}(\text{CH}_3\text{COO})_2 \cdot 3\text{H}_2\text{O}$
250 g

Very hot water to 500 mL

Stir until dissolved.

- Sodium hydroxide solution, 1 M
- Calcium carbonate.

3.1.2 Procedure

- Dry wines.

Place 50 mL of the wine in a 100 mL volumetric flask; add 0.5 (n - 0.5) mL sodium hydroxide solution, 1 M, (where n is the volume of sodium hydroxide solution, 0.1 M, used to determine the total acidity in 10 mL of wine). Add, while stirring, 2.5 mL of saturated lead acetate solution and 0.5 g calcium carbonate. Shake several times and allow to stand for at least 15 minutes. Make up to the mark with water. Filter.

1 mL of the filtrate corresponds to 0.5 mL of the wine.

- Musts, mistelles, sweet and semi-sweet wines

Into a 100 mL volumetric flask, place the following volumes of wine (or must or mistelle), the dilutions being given for guidance:

Case 1 - Musts and mistelles: prepare a 10% (v/v) solution of the liquid to be analyzed and take 10 mL of the diluted sample.

Case 2 - Sweet wines, whether fortified or not, having a density between 1.005 and 1.038: prepare a 20% (v/v) solution of the liquid to be analyzed and take 20 mL of the diluted sample.

Case 3 - Semi-sweet wines having a density between 0.997 and 1.005: take 20 mL of the undiluted wine.

Add 0.5 g calcium carbonate, about 60 mL water and 0.5, 1 or 2 mL of saturated lead acetate solution. Stir and leave to stand for at least 15 minutes, stirring occasionally. Make up to the mark with water. Filter.

Note:

Case 1: 1 mL of filtrate contains 0.01 mL of must or mistelle.

Case 2: 1 mL of filtrate contains 0.04 mL of sweet wine.

Case 3: 1 mL of filtrate contains 0.20 mL of semi-sweet wine.

3.2. Clarification by zinc ferrocyanide (II)

This clarification process should be used only for white wines, lightly colored sweet wines and musts.

3.2.1 Reagents

Solution I: potassium ferrocyanide (II):

COMPENDIUM OF INTERNATIONAL METHODS OF ANALYSIS-OIV
Reducing substances

Potassium ferrocyanide (II), $K_4Fe(CN)_6 \cdot 3H_2O$	150 g
Water to	1000 mL
Solution II: zinc sulfate:	
Zinc sulfate, $ZnSO_4 \cdot 7H_2O$	300 g
Water to	1000 mL

3.2.2 Procedure

Into a 100 mL volumetric flask, place the following volumes of wine (or must or mistelle), the dilutions being given for guidance:

Case 1 - Musts and mistelles. Prepare a 10% (v/v) solution of the liquid to be analyzed and take 10 mL of the diluted sample.

Case 2 - Sweet wines, whether fortified or not, having a density between 1.005 and 1.038: prepare a 20% (v/v) solution of the liquid to be analyzed and take 20 mL of the diluted sample.

Case 3 - Semi-sweet wines having a density at 20°C between 0.997 and 1.005: take 20 mL of the undiluted wine.

Case 4 - Dry wines: take 50 mL of undiluted wine.

Add 5 mL of solution I and 5 mL of solution II. Stir. Make up to the mark with water. Filter.

Note:

Case 1: 1 mL of filtrate contains 0.01 mL of must or mistelle.

Case 2: 1 mL of filtrate contains 0.04 mL of sweet wine.

Case 3: 1 mL of filtrate contains 0.20 mL of semi-sweet wine.

Case 4: 1 mL of filtrate contains 0.50 mL of dry wine.

4. Determination of sugars

4.1. Reagents

- Alkaline copper salt solution:

Copper sulfate, pure, $CuSO_4 \cdot 5H_2O$	25 g
Citric acid monohydrate	50 g

COMPENDIUM OF INTERNATIONAL METHODS OF ANALYSIS-OIV
Reducing substances

Crystalline sodium carbonate, $\text{Na}_2\text{CO}_3 \cdot 10\text{H}_2\text{O}$

388 g

Water to 1000 mL

Dissolve the copper sulfate in 100 mL of water, the citric acid in 300 mL of water and the sodium carbonate in 300 to 400 mL of hot water. Mix the citric acid and sodium carbonate solutions. Add the copper sulfate solution and make up to one liter.

- Potassium iodide solution, 30% (*m/v*):

Potassium iodide, KI 30 g

Water to 100 mL

Store in a colored glass bottle.

- Sulfuric acid, 25% (*m/v*):

Concentrated sulfuric acid, H_2SO_4 , $\rho_{20} = 1.84$ g/ml

25 g

Water to 100 mL

Add the acid slowly to the water, allow to cool and make up to 100 mL with water.

- Starch solution, 5 g/L:

Mix 5 g of starch in with about 500 mL of water. Bring to boil, stirring all the time, and boil for 10 minutes. Add 200 g of sodium chloride, NaCl. Allow to cool and then make up to one liter with water.

- Sodium thiosulfate solution, 0.1 M.

- Invert sugar solution, 5 g/L, to be used for checking the method of determination.

Place the following into a 200 mL volumetric flask:

Pure dry sucrose 4.75 g

Water, approximately 100 mL

Conc. hydrochloric acid ($\rho_{20} = 1.16 - 1.19$ g/mL) 5 mL

Heat the flask in a water-bath maintained at 60°C until the temperature of the solution reaches 50°C; then keep the flask and solution at 50°C for 15 minutes. Allow the flask to cool naturally for 30 minutes and then immerse it in a cold water-bath. Transfer the solution to a one-liter volumetric flask and make up to one liter. This solution keeps satisfactorily for a month. Immediately before use, neutralize the test sample (the solution being approximately 0.06 M acid) with sodium hydroxide solution.

COMPENDIUM OF INTERNATIONAL METHODS OF ANALYSIS-OIV
Reducing substances

4.2. Procedure

Mix 25 mL of the alkaline copper salt solution, 15 mL water and 10 mL of the clarified solution in a 300 mL conical flask. This volume of sugar solution must not contain more than 60 mg of invert sugar.

Add a few small pieces of pumice stone. Fit a reflux condenser to the flask and bring the mixture to the boil within two minutes. Keep the mixture boiling for exactly 10 minutes.

Cool the flask immediately in cold running water. When completely cool, add 10 mL potassium iodide solution, 30% (*m/v*); 25 mL sulfuric acid, 25% (*m/v*), and 2 mL starch solution.

Titrate with sodium thiosulfate solution, 0.1 M. Let *n* be the number of mL used. Also carry out a blank titration in which the 25 mL of sugar solution is replaced by 25 mL of distilled water. Let *n'* be the number of mL of sodium thiosulfate used.

4.3. Expression of results

4.3.1 Calculations

The quantity of sugar, expressed as invert sugar, contained in the test sample is given in the table below as a function of the number (*n' - n*) of mL of sodium thiosulfate used.

The sugar content of the wine is to be expressed in grams of invert sugar per liter to one decimal place, account being taken of the dilution made during clarification and of the volume of the test sample.

Table giving the relationship between the volume of sodium thiosulfate solution: (<i>n' - n</i>) mL. and the quantity of reducing sugar in mg.					
Na ₂ S ₂ O ₃ (ml 0.1 M)	Reducing sugars (mg)	Diff.	Na ₂ S ₂ O ₃ (ml 0.1 M)	Reducing sugars (mg)	Diff.
1	2.4	2.4	13	33.0	2.7

COMPENDIUM OF INTERNATIONAL METHODS OF ANALYSIS-OIV
Reducing substances

2	4.8	2.4	14	35.7	2.8
3	7.2	2.5	15	38.5	2.8
4	9.7	2.5	16	41.3	2.9
5	12.2	2.5	17	44.2	2.9
6	14.7	2.6	18	47.2	2.9
7	17.2	2.6	19	50.0	3.0
8	19.8	2.6	20	53.0	3.0
9	22.4	2.6	21	56.0	3.1
10	25.0	2.6	22	59.1	3.1
11	27.6	2.7	23	62.2	
12	30.3	2.7			

BIBLIOGRAPHY

- JAULMES P., *Analyses des vins*, 1951, 170, Montpellier.
JAULMES P., BRUN Mme S., ROQUES Mme J., *Trav. Soc. Pharm.*, 1963, **23**, 19.
SCHNEYDER J., VLECK G., *Mitt. Klosterneuburg, Rebe und Wein*, 1961, sér. A, 135.

Method OIV-AS311-01B

Reducing sugars
(Resolution OIV/OENO 377/2009)

Principle of the method

Clarification

After neutralization and removal of alcohol, the wine is passed through an anion-exchange resin column in the acetate form, followed by clarification with neutral lead acetate.

WITHDRAWN

Method OIV-AS311-01C

Type II method

Reducing sugars
(Resolution OIV/OENO 377/2009)

Principle of the method

Determination

Single method: the clarified wine or must is reacted with a specific quantity of an alkaline copper salt solution and the excess copper ions are then determined iodometrically.

WITHDRAWN

Glucose and fructose

(Resolution OIV/OENO 377/2009)

1. Definition

Glucose and fructose may be determined individually by an enzymatic method, with the sole aim of calculating the glucose/fructose ratio.

2. Principle

Glucose and fructose are phosphorylated by adenosine triphosphate (ATP) during an enzymatic reaction catalyzed by hexokinase (HK), to produce glucose-6-phosphate (G6P) and fructose-6-phosphate (F6P):



The glucose-6-phosphate is first oxidized to gluconate-6-phosphate by nicotinamide adenine dinucleotide phosphate (NADP) in the presence of the enzyme glucose-6-phosphate dehydrogenase (G6PDH). The quantity of reduced nicotinamide adenine dinucleotide phosphate (NADPH) produced corresponds to that of glucose-6-phosphate and thus to that of glucose.

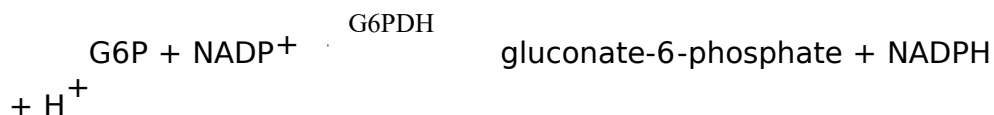

The reduced nicotinamide adenine dinucleotide phosphate is determined from its absorption at 340 nm.

At the end of this reaction, the fructose-6-phosphate is converted into glucose-6-phosphate by the action of phosphoglucose isomerase (PGI):



F6P

G6P

The glucose-6-phosphate again reacts with the nicotinamide adenine dinucleotide phosphate to give gluconate-6-phosphate and reduced nicotinamide adenine dinucleotide phosphate, and the latter is then determined.

3. Apparatus

- A spectrophotometer enabling measurements to be made at 340 nm, the wavelength at which absorption by NADPH is at a maximum. Absolute measurements are involved (i.e. calibration plots are not used but standardization is made using the extinction coefficient of NADPH), so that the wavelength scales of, and absorbance values obtained from, the apparatus must be checked.

If not available, a spectrophotometer using a source with a discontinuous spectrum that enables measurements to be made at 334 nm or at 365 nm may be used.

- Glass cells with optical path lengths of 1 cm or single-use cells.
- Pipettes for use with enzymatic test solutions, 0.02, 0.05, 0.1, 0.2 mL.

4. Reagents

Solution 1: buffer solution (0.3 M triethanolamine, pH 7.6, 0.004 M Mg^{2+}): dissolve 11.2 g triethanolamine hydrochloride, $(CH_2CH_2OH)_3N.HCl$, and 0.2 g magnesium sulfate, $MgSO_4 \cdot 7H_2O$, in 150 mL of double-distilled water, add about 4 mL 5 M sodium hydroxide solution to obtain a pH value of 7.6 and make up to 200 mL.

This buffer solution may be kept for four weeks at approx. + 4°C.

Solution 2: nicotinamide adenine dinucleotide phosphate solution (about 0.0115 M): dissolve 50 mg disodium nicotinamide adenine dinucleotide phosphate in 5 mL of double-distilled water.

This solution may be kept for four weeks at approx. +4°C.

Solution 3: adenosine-5'-triphosphate solution (approx. 0.081 M): dissolve 250 mg disodium adenosine-5'-triphosphate and 250 mg sodium hydrogen carbonate, $NaHCO_3$, in 5 mL of double-distilled water.

This solution may be kept for four weeks at approx. +4°C.

Solution 4: hexokinase/glucose-6-phosphate-dehydrogenase: mix 0.5 mL hexokinase (2 mg of protein/mL or 280 U/mL with 0.5 mL glucose-6-phosphate-dehydrogenase (1 mg of protein/mL). This mixture may be kept for a year at approx. +4°C.

Solution 5: phosphoglucose-isomerase (2 mg of protein/mL or 700 U/mL). The suspension is used undiluted. This may be kept for a year at approx. +4°C.

Note: All solutions used above are available commercially.

5. Procedure

5.1. Preparation of sample

Depending on the estimated amount of glucose + fructose per liter (g/L) dilute the sample as follows:

Measurement at 340 and 344 nm (g/L)	Measurement at 365 nm (g/L)	Dilution with water	Dilution factor F
up to 0.4	0.8	-	-
up to 4.0	8.0	1 + 9	10
up to 10.0	20.0	1 + 24	25
up to 20.0	40.0	1 + 49	50
up to 40.0	80.0	1 + 99	100
above 40.0	80.0	1 + 999	1000

5.2. Determination

With the spectrophotometer adjusted to the 340 nm wavelength, make measurements using air (no cell in the optical path) or water as reference.

Temperature between 20 and 25°C.

Into two cells with 1 cm optical paths, place the following:

	Reference cell	Sample
cell		

COMPENDIUM OF INTERNATIONAL METHODS OF ANALYSIS-OIV
Glucose and fructose

Solution 1 (taken to 20°C)	2.50	mL
	2.50 mL	
Solution 2	0.10	mL
	0.10 mL	
Solution 3	0.10	mL
	0.10 mL	
Sample to be measured	0.20	
mL		
Double -distilled water.....	0.20	mL

Mix, and after three minutes read the absorbance of the solutions (A_1). Start the reaction by adding:

Solution 4	0.02	mL
	0.02 mL	

Mix, read the absorbance after 15 minutes and after two more minutes check that the reaction has stopped (A_2).

Add immediately:

Solution 5	0.02	mL
	0.02 mL	

Mix; read the absorbance after 10 minutes and after two more minutes check that the reaction has stopped (A_3).

Calculate the differences in the absorbance between the reference cell and sample cells.:

$A_2 - A_1$ corresponds to glucose,
 $A_3 - A_2$ corresponds to fructose,

Calculate the differences in absorbance for the reference cells (ΔA_T) and the sample cell (ΔA_D) and then obtain:

$$\text{for glucose: } \Delta A_G = \Delta A_D - \Delta A_T$$

$$\text{for fructose: } \Delta A_F = \Delta A_D - \Delta A_T$$

Note: The time needed for the completion of enzyme activity may vary from one batch to another. The above value is given only for guidance and it is recommended that it be determined for each batch.

5.3. Expression of results

5.3.1 Calculation

The general formula for calculating the concentrations is:

$$C = \frac{V \times MV}{\varepsilon \times d \times v \times 10000} \Delta A \text{ (g/L)}$$

where:

V = volume of the test solution (mL)

v = volume of the sample (mL)

MW = molecular mass of the substance to be determined

d = optical path in the cell (cm)

ε = absorption coefficient of NADPH at 340 nm = 6.3

(mmole⁻¹ x l x cm⁻¹)

V = 2.92 mL for the determination of glucose

V = 2.94 mL for the determination of fructose

v = 20 mL

PM = 180

d = 1

so that:

$$\text{For glucose : } C(\text{g/L}) = 0.417 \times \Delta A_G$$

$$\text{For fructose: } C(\text{g/L}) = 0.420 \times \Delta A_F$$

If the sample was diluted during its preparation, multiply the result by the dilution factor F.

Note: If the measurements are made at 334 or 365 nm, then the following expressions are obtained:

• measurement at 334 nm: $\varepsilon = 6.2$ (mmole⁻¹ × absorbance × cm⁻¹)

$$\text{for glucose : } C(\text{g/L}) = 0.425 \times \Delta A_G$$

$$\text{for fructose: } C(\text{g/L}) = 0.428 \times \Delta A_F$$

• measurement at 365 nm: $\varepsilon = 3.4$ (mmole⁻¹ × absorbance × cm⁻¹)

$$\text{for glucose: } C(\text{g/L}) = 0.773 \times \Delta A_G$$

$$\text{for fructose: } C(\text{g/L}) = 0.778 \times \Delta A_F$$

5.3.2 Repeatability (*r*):

$$r = 0.056 x_j$$

x_j = the concentration of glucose or fructose in g/L

5.3.3 Reproducibility (*R*):

$$R = 0.12 + 0.076 x_j$$

x_j = the concentration of glucose or fructose in g/L

BIBLIOGRAPHY

BERGMEYER H.U., BERNT E., SCHMIDT F. and STORK H., *Méthodes d'analyse enzymatique* by BERGMEYER H.U., 2e éd., p. 1163, Verlag-Chemie Weinheim/Bergstraße, 1970.

BOEHRINGER Mannheim, *Méthodes d'analyse enzymatique en chimie alimentaire*, documentation technique.
JUNGE Ch., *F.V., O.I.V.*, 1973, No 438.

Method OIV-MA-AS311-03

Type II method¹

Dosage of sugars in wine by HPLC

OENO 23/2003

OIV/OENO 377/2009

OIV-OENO 526-2016

1. SCOPE OF APPLICATION

This method is applicable to the direct quantification of sugars in musts and wines up to 20 g/L and, after dilution, beyond.

Glycerol (between 0.5 and 15 g/L) and sucrose (between 1 and 40 g/L) may also be quantified in the same way.

2. PRINCIPLE

Sugars and glycerol are separated by HPLC using an alkylamine column and detected by refractometer.

3. REAGENTS

- 3.1 - Demineralised Type I water (ISO 3696) or equivalent (HPLC grade);
- 3.2 - acetonitrile [75-05-8] (minimal transmission at 200 nm - purity \geq 99%);
- 3.3 - fructose [57-48-7] (purity \geq 99%);
- 3.4 - glucose [492-62-6] (purity \geq 99%);
- 3.5 - sucrose [57-50-1] (purity \geq 99%);
- 3.6 - glycerol [56-81-5] (purity \geq 99%).

PREPARATION OF REAGENT SOLUTIONS

- 3.9 - Demineralised water (3.1): filtered through a 0.45 μ m cellulose membrane;
- 3.10 - eluent: acetonitrile (3.2)/water (3.9) with a respective ratio of 80/20.

Note 2: the water/acetonitrile ratio may be adapted according to the objectives.

4. APPARATUS

- 4.1. - 0.45 μ m Cellulose filtration membrane;
- 4.2. - silica-based, octadecyl-bonded filter cartridge (e.g. Sep-Pak C₁₈);
- 4.3. - common apparatus for high-performance liquid chromatography;
- 4.4. - alkylamine column (5 μ m, 250 x 4.6 mm);

Note 3: columns of different lengths, internal diameter and particle size may be used but the type II method refers to the dimensions provided.

¹ Type II for glucose and fructose. Type IV for sucrose and glycerol.

- 4.5. - refractometric index detector (RID);
- 4.6. - common laboratory apparatus.

5. SAMPLING

The samples are degassed beforehand if necessary (e.g. with nitrogen or helium, or in an ultrasonic bath).

6. PROCEDURE

6.1 - Preparation of the sample

6.1.1 - Dilution

Wines containing less than 20 g/L of (glucose + fructose) are analysed undiluted. Musts and wines containing more than 20 g/L have to be diluted to be within the range of calibration.

6.1.2 - Filtration

The samples must be filtered using a 0.45 µm membrane (4.1) before analysis.

6.1.3 - Elimination of phenolic compounds (if necessary)

For a must or wine, pass over a C₁₈ cartridge (4.2).

6.2 - Analyses

6.2.1 - Analytical conditions

Note 4: The following instructions are mandatory for the type II method.

Note 5: Conditions may be adapted by the laboratory with the loss of the type II reference.

HPLC system (4.3) equipped with column (4.4) and RID (4.5).

Mobile phase: isocratic acetonitrile/water eluent (3.10).

Flow: 1 mL/min.

Injected volume: between 10 and 50 µL, to be adapted according to the material used.

Examples of chromatograms are shown in Annex B (Figures 1 and 2).

The fructose-glucose resolution is recommended to be ≥ 2 .

6.2.2 - External calibration

The calibration solution that applies to all compounds described in this procedure may contain the following:

10 g/L glycerol (3.6) \pm 0.01 g/L,

10 g/L fructose (3.3) \pm 0.01 g/L,

10 g/L glucose (3.4) \pm 0.01 g/L,

10 g/L sucrose (3.5) \pm 0.01 g/L.

Note 6: if quantifying only one of these compounds, a solution that contains only the one required can be prepared.

6.3 - Calculation of response factors for external calibration used in routine analyses

$$RF_i = \text{area}_i / C_i$$

where

area *i* = peak area of the product in the calibration solution

and *C*_{*i*} = quantity of product present in the calibration solution.

It is also possible to use a calibration curve.

7. EXPRESSION OF RESULTS

7.1 - Calculation of concentrations

$$C_e = \text{area}_e / RF_i$$

where

area_e = peak area of product present in the sample.

The results are expressed in g/L.

Note 7: the results are indicated to a maximum of one decimal place.

8. QUALITY ASSURANCE AND CONTROL

Traceable to the international references through mass, volume and temperature.

Synthetic mixtures or samples coming, for instance, from proficiency ring test are used as internal quality control. A control chart may be used

9. PERFORMANCE OF THE METHOD

No known compound co-elutes with fructose, glucose or sucrose.

Robustness: the analysis is sensitive to slight variations in temperature. Columns should be protected from temperature variations.

10. PRECISION

(See Annex B.3)

10.1 - Glucose (content ≥ 3 g/L)

Repeatability limit \cong reproducibility limit = 13%

10.2 - Fructose (content ≥ 2 g/L)

Repeatability limit = 7%

Reproducibility limit = 10%

10.3 – Glucose + fructose (content ≥ 5 g/L)

Repeatability limit \cong Reproducibility limit = 10%

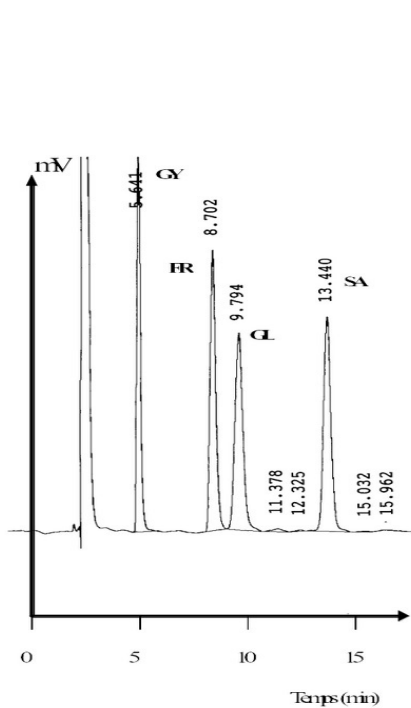

Figure 1
Chromatogram of a calibration
solution (sugars and glycerol at 10 g/L.)

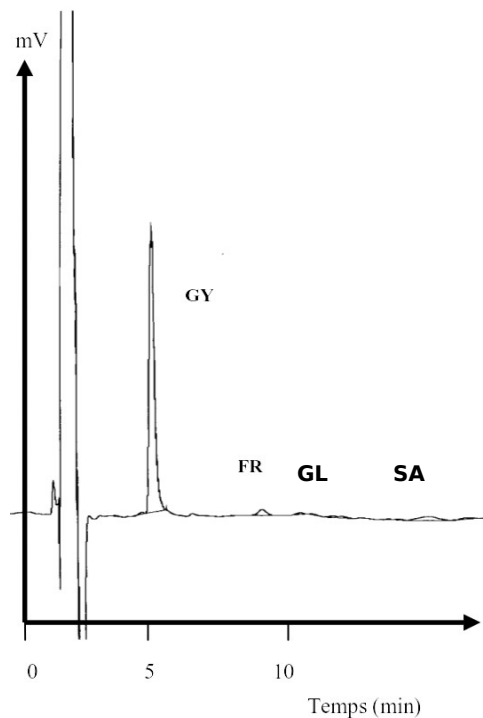
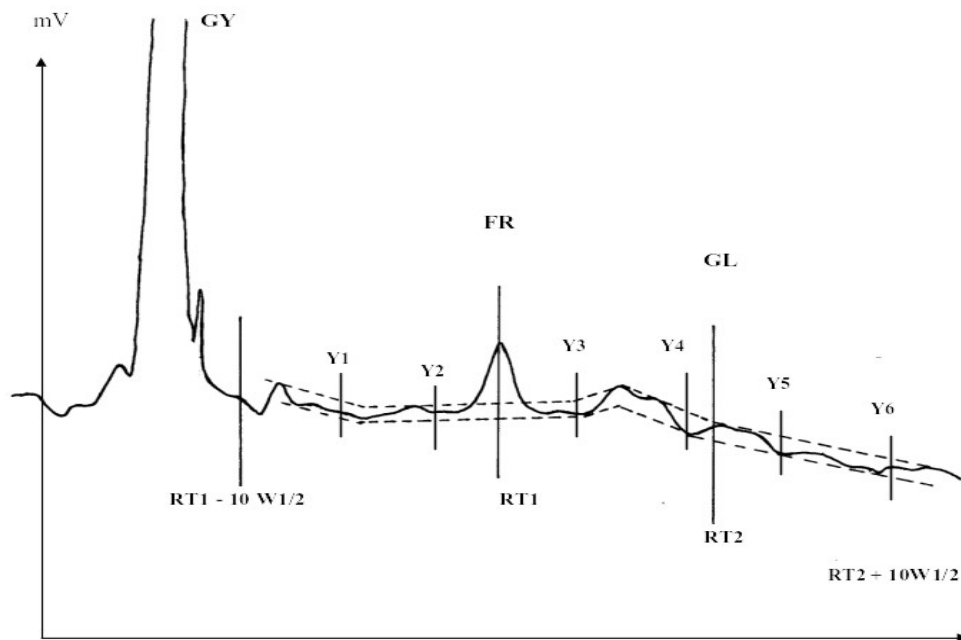

Figure 2
Chromatogram of a rosé wine

Glycerol (GY), fructose (FR), glucose (GL), saccharose (SA)



fructose (FR), glucose (GL), saccharose (SA) Glycerol (GY),

Figure 3 - Measure of pitches of noise after enlargement of chromatogram

RT1: retention time of fructose; RT2: retention time of glucose
W1/2: width of peak at mid-height; Yi: pitch of noise at point i

Annex B

(informative)

Precision data

B.1 - Samples in the interlaboratory test trial

This study was carried out by the Interregional Laboratory of the Répression de Fraudes in Bordeaux. The test trial involved 6 samples in blind duplicates (12 samples in total), identified as A to J (4 white wines and 4 red wines; 2 white Port wines and 2 red Port wines), containing glucose and fructose and whose content of each sugar was between 2 and 65 g/L. The wines from the region of Bordeaux were supplemented with glucose and fructose and stabilised with 100 mg/L of SO₂ (TRICARD and MEDINA, 2003).

B.2 - Chromatographic conditions

Considering the response factors of these two sugars and the scales of the chromatograms, the noise corresponds to a concentration of 0.04 g/L for fructose and of 0.06 g/L for glucose (see Figure A3).

The limits of detection (3 times the noise) and of quantification (10 times the noise) are then obtained:

$$LD_{\text{fructose}} = 0.12 \text{ g/L,}$$

$$LD_{\text{glucose}} = 0.18 \text{ g/L,}$$

$$LQ_{\text{fructose}} = 0.4 \text{ g/L,}$$

$$LQ_{\text{glucose}} = 0.6 \text{ g/L.}$$

These results are compliant with those determined by TUSSEAU and BOUNIOL (1986) and are repeatable on other chromatograms.

B.3 - Precision

Nine laboratories participated in the interlaboratory study:

Istituto Sperimentale per l'Enologia, Asti, Italy;

Laboratoire de la DGCCRF de Montpellier, France;

Laboratoire LARA, Toulouse, France;

Instituto do vinho do Porto, Porto, Portugal;

Instituto da Vinha e do Vinho, Unhos, Portugal;

COMPENDIUM OF INTERNATIONAL METHODS OF ANALYSIS-OIV
Dosage of sugars in wine by HPLC

Estación de Viticultura y Enología, Vilafranca del Penedés, Spain;
Comité Interprofessionnel du vin de Champagne, Epernay, France;
Station fédérale de Changins, Switzerland;

Laboratoire de la DGCCRF de Talence, France.

The analyses of 3 points of the set of calibration solutions and the 12 samples were carried out successively by applying the method of analysis given.

The results were analysed according to the OIV protocol (Validation protocol of methods of analysis – Resolution OENO 6/1999).

This protocol does not require the analyses to be repeated, whereas 4 laboratories gave results of analyses repeated 3 times. A single series was chosen (the first one) for the analysis of the results, in compliance with the OIV protocol.

The calculations of repeatability according to Youden, reproducibility and Cochran and Grubbs tests were performed.

Data on the repetitions made it possible to work out the standard deviations of repeatability in another way (according to ISO 5725).

COMPENDIUM OF INTERNATIONAL METHODS OF ANALYSIS-OIV
Dosage of sugars in wine by HPLC

B.3.1 – GLUCOSE

Glucose by HPLC (g/L)						
Number of laboratories	9	9	9	9	9	9
Number of samples	2	2	2	2	2	2
Average value	2.9	2.9	12.6	12.4	44.6	67.5
Repeatability standard deviation	0.44	0.17	0.67	0.34	1.05	3.31
Repeatability limit	1.42	0.55	2.15	1.07	3.35	10.58
Reproducibility standard deviation	0.78	0.30	0.90	0.52	1.43	3.28
Reproducibility limit	2.32	0.90	2.68	1.55	4.28	9.78
Horrrat value	5.7*	2.1	1.84	1.08	1.01	1.62

* not taken into account for the expression of precision

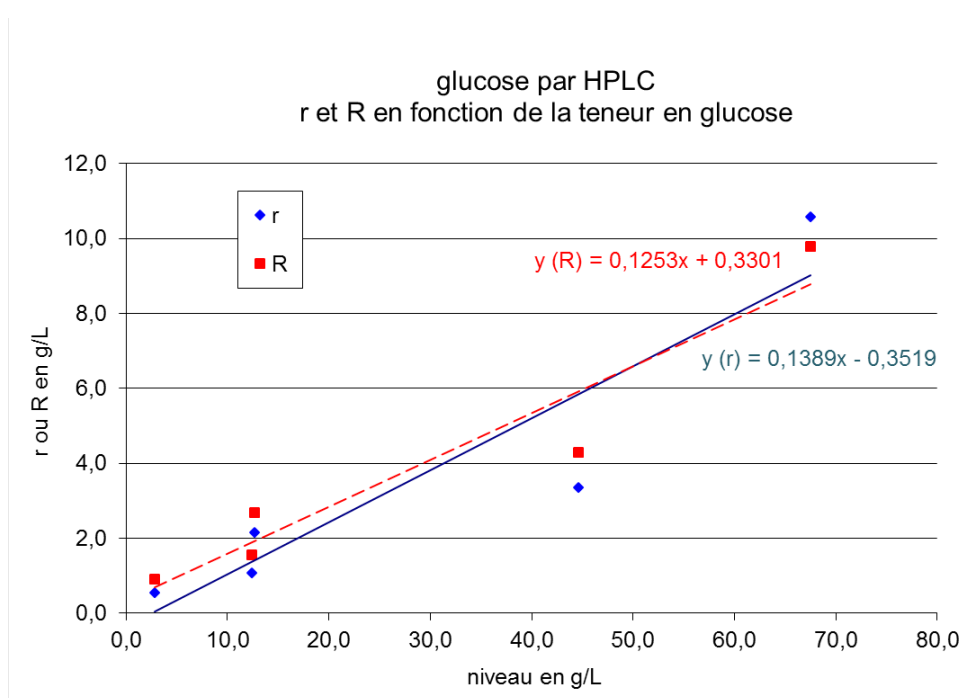

Correlation between r and R and the concentration for glucose (ISO 5725)

B.3.2 – FRUCTOSE

Fructose by HPLC (g/L)						
Number of laboratories	9	9	9	9	9	9
Number of samples	2	2	2	2	2	2
Average value	1.9	5.2	10.0	13.0	62.6	73.0
Repeatability standard deviation	0.09	0.24	0.32	0.16	3.20	2.10
Repeatability limit	0.27	0.79	1.03	0.51	3.20	6.72
Reproducibility standard deviation	0.25	0.25	0.32	0.43	2.91	1.93
Reproducibility limit	0.75	0.75	0.96	1.30	8.68	5.77
Horrat value	2.54	1.09	0.81	0.87	1.53	0.89

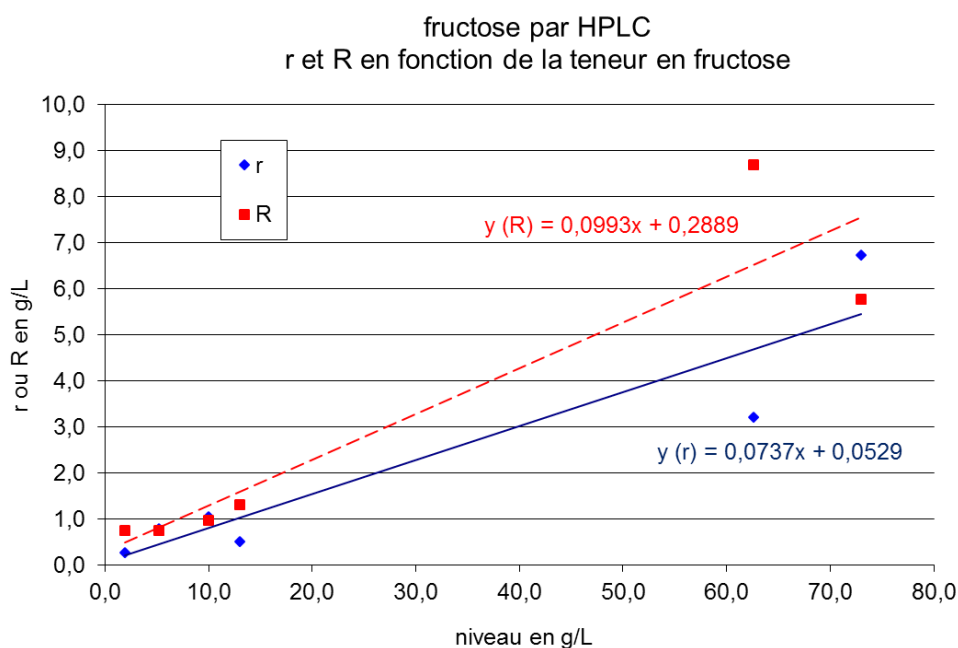

Correlation between r and R and the concentration for fructose (ISO 5725)

COMPENDIUM OF INTERNATIONAL METHODS OF ANALYSIS-OIV
Dosage of sugars in wine by HPLC

B.3.3 – GLUCOSE + FRUCTOSE

Glucose + fructose by HPLC (g/L)						
Number of laboratories	9	9	9	9	9	9
Number of samples	2	2	2	2	2	2
Average value	4.7	8.1	22.6	25.4	107.3	140.5
Repeatability standard deviation	0.48	0.38	1.06	0.46	1.92	5.30
Repeatability limit	1.52	1.21	3.07	1.48	6.13	17.0
Reproducibility standard deviation	0.89	0.46	1.06	0.64	3.47	4.74
Reproducibility limit	2.64	1.38	3.17	1.90	10.34	14.15
Horrat value	4.17*	1.39	1.33	0.72	1.15	1.26

* not taken into account for the expression of precision

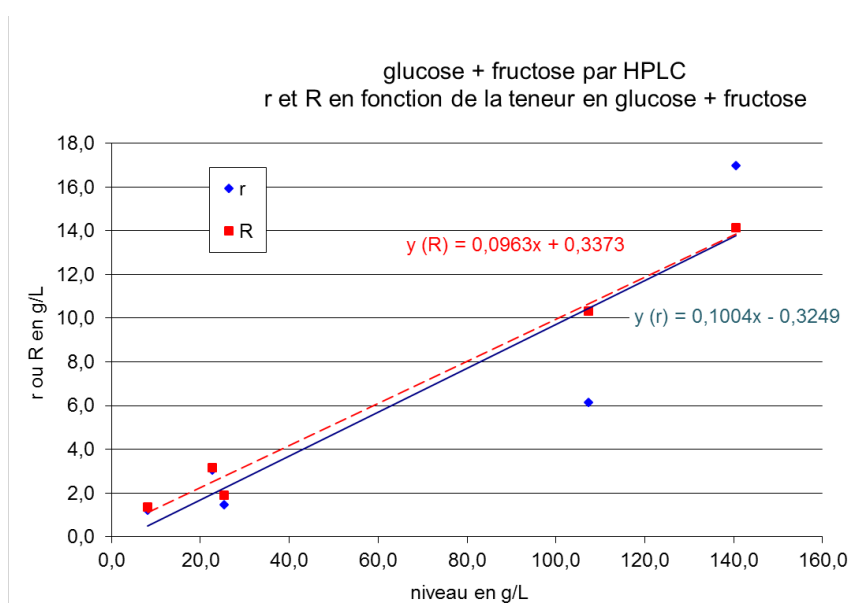

Correlation between r and R and the concentration for glucose + fructose (ISO 5725)

Bibliography

- TRICARD, C. and MEDINA, B., 'Essai inter laboratoire OIV – Dosage des sucres dans les vins par HPLC', *FV 1143*, 2003, 8 pages.
- TUSSEAU, D. and BOUNIOL, C., *Sc. Alim.*, No. 6, 1986, pp. 559-577.
- TUSSEAU, D., 'Limite de détection - limite de quantification', *FV OIV 1000*, 1996.
- 'Protocol for the design, conduct and interpretation of collaborative studies', *Resolution OIV-OENO 6-2000*.
- 'Application of statistics - Accuracy (trueness and precision) of measurement methods and results -...', *ISO Standard 5725*, 1994.

Method OIV-MA-AS311-04

Stabilization of Musts to Detect the Addition of Sucrose

1. Principle of the method

The sample is brought to pH 7 with a sodium hydroxide solution and an equal volume of acetone is added.

The acetone is removed by distillation prior to determination of sucrose by TLC (thin-layer chromatography) and HPLC (high-performance liquid chromatography) (see *Sucrose* Chapter).

2 Apparatus

Distillation apparatus, with a 100 mL round distillation flask.

3 Reagents

3.1 Sodium hydroxide solution, 20% (*m/v*)

3.2 Acetone (propanone).

4 Method

4.1 *Stabilizing the samples*

20 mL of must is placed in a 100 mL strong-walled flask and brought to pH 7 with the 20% sodium hydroxide solution (*m/v*) (six to twelve drops). 20 mL of acetone are added. Stopper and store at low temperature.

WARNING: ACETONE HAS HIGH VAPOUR PRESSURE AND IS HIGHLY INFLAMMABLE.

4.2 *Preparing the sample to determine sucrose by TLC or HPLC.*

Place the contents of the flask in the 100 mL round flask of the distillation apparatus. Distil and collect approximately 20 mL of distillate, which is discarded. Add 20 mL of water to the contents of the distilling flask and distil again, collecting about 25 mL of distillate, which is discarded.

Transfer the contents of the distillation flask to a graduated 20 mL volumetric flask and make up to the mark with the rinsing water from the round flask. Filter. Analyze the filtrate and (if detected) measure the sucrose using TLC or HPLC.

BIBLIOGRAPHY

TERCERO C., *F.V., O.I.V.*, 1972, No. 420 and 421.

COMPENDIUM OF INTERNATIONAL ANALYSIS OF METHODS - OIV
Determination of the deuterium distribution in ethanol by
SNIF-NMR

Method OIV-MA-AS311-05

Type II method

**Determination of the deuterium distribution in ethanol
derived from fermentation of grape musts, concentrated
grape musts, grape sugar (rectified concentrated grape
musts) and wines by application of nuclear magnetic
resonance (SNIF-NMR/ RMN-FINS ¹)
(OIV-OENO 426-2011)**

Introduction

The deuterium contained in the sugars and the water in grape must is redistributed after fermentation in molecules I, II, III and IV of the wine:

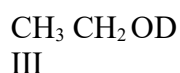

Scope

The method enables measurement of the Deuterium isotope ratios (D/H) in wine ethanol and ethanol obtained by fermentation of products of the vine (musts, concentrated musts, rectified concentrated musts).

Definitions

(D/H)_I : Isotope ratio associated with molecule I

(D/H)_{II} : Isotope ratio associated with molecule II

(D/H)_w^Q : Isotope ratio of the water in the wine (or in fermented products)

$$R = 2(\text{D/H})_{\text{II}}/(\text{D/H})_{\text{I}}$$

¹ Fractionnement Isotopique Naturel Spécifique étudié par Résonance Magnétique Nucléaire (Site Specific Natural Isotope Fractionation studied by Nuclear Magnetic Resonance). Brevet: France, 8122710; Europe, 824022099; Etats Unis, 854550082; Japon 57123249.

COMPENDIUM OF INTERNATIONAL ANALYSIS OF METHODS - OIV
Determination of the deuterium distribution in ethanol by
SNIF-NMR

R expresses the relative distribution of deuterium in molecules I and II; R is measured directly from the intensities h (peak heights) of the signals and then $R = 3h_{II}/h_I$.

Principle

The above defined parameters R , $(D/H)_I$ and $(D/H)_{II}$ are determined by nuclear magnetic resonance of the deuterium in the ethanol extracted from the wine or from the fermentation products of the must, the concentrated must or the grape sugar (rectified concentrated must) obtained under given conditions.

Reagents and materials

5.1 reagents:

5.1.1 reagents for the determination of water by the Karl Fischer method (when this method is used for the measurement of the alcohol grade of the distillate).

5.1.2 Hexafluorobenzene (C₆F₆) used as lock substance

5.1.3 Trifluoroacetic acid (TFA, CAS: 76-05-1) or alternatively trifluoroacetic anhydride (TFAA, CAS: 407-25-0)

5.2 Reference Materials (available from the Institute for Reference Materials and Measurements IRMM in Geel (B)):

5.2.1 Sealed NMR tubes CRM-123, used to check the calibration of the NMR instrumentation

5.2.2 Standard N,N-tetramethyl urea (TMU); standard TMU with a calibrated isotope ratio D/H.

COMPENDIUM OF INTERNATIONAL ANALYSIS OF METHODS - OIV
Determination of the deuterium distribution in ethanol by
SNIF-NMR

5.2.3 Other CRMs available used to check the distillation and preparation steps:

CRM		Parameter	Certified value	Uncertainty
CRM-656	Ethanol from wine, 96% vol.			
		t^D (ethanol) in % w/w	94.61	0.05
		$\delta^{13}C$ (ethanol) in ‰ VPDB	-26.91	0.07
		(D/H) _I (ethanol) in ppm	102.84	0.20
		(D/H) _{II} (ethanol) in ppm	132.07	0.30
		R (ethanol)	2.570	0.005
CRM-660	hydro alcoholic solution, 12% vol.			
		t^Q (ethanol) in % vol.	11.96	0.06
		$\delta^{13}C$ (ethanol) in ‰ VPDB	-26.72	0.09
		(D/H) _I (ethanol) in ppm	102.90	0.16
		(D/H) _{II} (ethanol) in ppm	131.95	0.23
		R	2.567	0.005
		(D/H) _w (water) in ppm	148.68	0.14

5.3 Apparatus

5.3.1 NMR spectrometer fitted with a specific 'deuterium' probe tuned to the characteristic frequency ν_0 of the field B_0 (e.g. for $B_0 = 7.05$ T, $\nu_0 = 46.05$ MHz and for $B_0 = 9.4$ T, $\nu_0 = 61.4$ MHz) having a

proton decoupling channel (B2) and field-frequency stabilization channel (lock) at the fluorine frequency. The NMR instrument can possibly be equipped with an automatic sample changer and additional data-processing software for the evaluation of the spectra and computation of the results. The performance of the NMR spectrometer can be checked using the Certified Reference Materials (sealed tubes CRM 123).

5.3.2 10 mm NMR sample tubes

5.3.3 Distillation apparatus

Note: Any method for ethanol extraction can be used as long as the alcohol in the wine is recovered without isotopic fractionation.

The Cadiot column shown in figure 1 is an example of a manual distillation system that allows to extract 96 to 98.5% of the ethanol of a wine without isotopic fractionation and obtain a distillate with an alcohol grade of 92 to 93 in % w/w (95% vol.).

Such a system is composed of:

- Electric heating mantle with voltage regulator,
- One-liter round-bottom flask with ground glass neck joint,
- Cadiot column with rotating band (moving part in Teflon),
- conical flasks with ground glass neck joints, for collection of the distillate

Automatic distillation systems are also available.

The performance of the distillation system may be checked periodically for both the yield of extraction as well as for accuracy for the isotopic determination. This control can be done by distillation and measurement of CRM -660.

5.3.4 The following common laboratory equipment and consumables is needed:

- micropipette with appropriate tips,
- balance with 0.1 mg accuracy or better,
- balance with 0.1g accuracy or better
- single use syringe for transfer of liquids,
- precise graduated flasks (50ml, 100 ml, 250ml, ...)
- flasks equipped with airtight closing systems and inert septa (for storage of aliquots of wines, distillates and residues until measurement)

-equipment and consumables as specified in the other methods referred to herein.

The laboratory equipment and consumables indicated in the above lists are examples and may be replaced by other equipment of equivalent performance.

Sampling (Preparation of the sample)

6.1 If not yet available, determine the alcoholic strength of the wine or of the fermented product (tv) to better than the nearest 0.05 % vol. (eg. using the OIV method MA-F-AS312-01-TALVOL).

6.2 Extraction of the ethanol

Using the appropriate graduated flask, introduce a homogeneous sample of a suitable volume V ml of the wine or the fermented product into the round-bottom flask of the distillation apparatus. Place a ground conical flask to receive the distillate. Heat the product to be distilled to obtain a constant reflux ratio at the level of the condenser. Start the collection of the distillate when a stable temperature of the vapours typical of the ethanol-water azeotrope (78 °C) is reached and stop the collection when the temperature increases. The collection of distillate should be continued until the ethanol-water azeotrope is completely recovered.

When using manually a Cadiot column (Figure 1) the following procedure can be applied:

-Collect the boiling liquid corresponding to the ethanol-water azeotrope, when the temperature increases, discontinue collection for five minutes. When the temperature returns to 78 °C, recommence collecting the distillate until the temperature of the vapours increases again. Repeat this operation until the temperature, after discontinuing collection, does not return to 78 °C.

Alternatively, commercially available distillation systems can be used.

The weight m^D of distillate collected is weighed to better than 0.1g.

COMPENDIUM OF INTERNATIONAL ANALYSIS OF METHODS - OIV
Determination of the deuterium distribution in ethanol by
SNIF-NMR

In order to avoid isotopic fractionation, the distillate should be kept in a tight vial preventing any evaporation until further use for determination of the alcoholic strength (6.3) and preparation of the NMR tube (7.1).

An aliquot of a few ml of the residues is kept. Its isotope ratio $(D/H)_w^o$ may be determined if required.

6.3 Determination of the alcoholic strength of the distillate

The alcoholic strength (%w/w) of the distillate must be determined with a precision better than 0.1%.

The water content of the distillate (ρ' g) can be determined by the Karl Fischer method using a sample of about 0.5 ml of alcohol of exactly known mass ρ g. The alcohol strength by mass of the distillate is then given by:

$$t_m^D \% w/w = 100 (1 - \rho') / \rho$$

Alternatively the alcoholic strength can be determined by densimetry for instance using an electronic densimeter.

6.4 Yield of distillation

The yield of distillation is estimated using the following formula:

$$\text{Yield of dist. \%} = 100 t_m^D m^D / (V \cdot tv)$$

Given the uncertainty on each term and especially on tv , the yield of distillation is estimated at $\pm 0.5\%$ (in the case of a wine of 10%v/v).

When using the Cadiot column, no significant isotope fractionation effect is expected for yield of extraction higher than 96%. In any case the operator may use a sufficient volume V ml of wine or fermented product for the distillation to ensure that the yield of extraction is sufficient. Typically aliquots of 750, 500, 400 and 300ml of wine sample should be sufficient to obtain a 96% yield when carrying out the above distillation procedure with the Cadiot column on wines or fermented products of respectively $tv = 4, 6, 8$ and 10% vol.

6.5 Fermentation of musts, concentrated musts and rectified concentrated musts

COMPENDIUM OF INTERNATIONAL ANALYSIS OF METHODS - OIV
Determination of the deuterium distribution in ethanol by
SNIF-NMR

Prior to use, the yeast can be reactivated in a small volume of must. The fermentation vessel is equipped with a device to keep it airtight and to avoid loss of ethanol.

6.5.1 Musts

Place about one litre of must, whose concentration of fermentable sugars has been previously determined, in the fermentation vessel. Add about 1 g of dry yeast eventually reactivated beforehand. Insert device to keep it airtight. Allow fermentation to proceed until the sugar is used up. The fermented product can then be distilled following the procedure already described for wine in 6.1 to 6.4

Note: Musts preserved by addition of sulphur dioxide have to be desulphited by bubbling nitrogen through the must in a water bath at 70 to 80 °C under reflux in order to prevent isotope fractionation through evaporation of water. Alternatively, the sulphur dioxide can be removed by a small addition of a solution of hydrogen peroxide (H₂O₂).

6.5.2 Concentrated musts

Place V ml of concentrated must containing a known amount of sugar (approximately 170 g) into the fermentation vessel. Top up to one litre with (1000 - V) ml of water. Add dry yeasts (1 g) and 3 g of Bacto Yeast Nitrogen Base without amino acids. Homogenize and proceed as described in 6.5.1.

6.5.3 Grape sugar (Rectified concentrated musts)

Proceed as described in 6.5.2, topping up to one litre with (1000 - V) ml of water also containing 3 g of dissolved tartaric acid.

Note: Concentrated musts and rectified concentrated musts are diluted in local water having a (D/H) isotope concentration different of that of the original must. By convention, the (D/H)_I and (D/H)_{II} parameters measured on ethanol have to be normalised as if the must had fermented in water having the same deuterium concentration as V-SMOW (155.76 ppm).

This normalisation of the data is performed by using the following equations (Martin et al., 1996, J. AOAC, 79, 62-72):

COMPENDIUM OF INTERNATIONAL ANALYSIS OF METHODS - OIV
Determination of the deuterium distribution in ethanol by
SNIF-NMR

$$\left(\frac{D}{H}\right)_I^{Norm.V-SMOW} = \left(\frac{D}{H}\right)_I - 0.19 \times \left[\left(\frac{D}{H}\right)_W^S - 155.76 \right]$$

$$\left(\frac{D}{H}\right)_{II}^{Norm.V-SMOW} = \left(\frac{D}{H}\right)_{II} - 0.78 \times \left[\left(\frac{D}{H}\right)_W^S - 155.76 \right]$$

where $\left(\frac{D}{H}\right)_W^S$ is the deuterium isotope ratio of the diluted must. This value can be computed using the equation of the Global Meteoric Water Line (Craig, 1961):

$$\left(\frac{D}{H}\right)_W^S = 155.76 \times \left[\frac{(8 \times d^{18}O + 10)}{1000} + 1 \right]$$

Where $d^{18}O$ is measured on the diluted must by the method for $^{18}O/^{16}O$ isotope ratio determination of water in wines and must [OIV-MA-AS2-12].

Retain 50 ml of sample of must or sulphur dioxide treated must or concentrated must or rectified concentrated must with a view to the possible extraction of the water and the determination of its isotope ratio $(D/H)_W^Q$.

Procedure

7.1 Preparation of alcohol sample for NMR measurement

- 10 mm diameter NMR probe: in a previously weighed bottle, collect 3.2 ml of distillate as described in section 6.2 and weigh it to the nearest 0.1 mg (m_A); then take 1.3 ml sample of the internal standard TMU (5.2.2) and weigh to the nearest 0.1 mg (m_{ST}).

Depending on the type of spectrometer and probe used, add a sufficient quantity of hexafluorobenzene (5.1.2) as a field-frequency stabilization substance (lock):

COMPENDIUM OF INTERNATIONAL ANALYSIS OF METHODS - OIV
Determination of the deuterium distribution in ethanol by
SNIF-NMR

Spectrometer	10 mm probe
7.05 T	150 μ l
9.4 T	35 μ l

These figures are indicative and the actual volume to be used should be adjusted to the sensitivity of the NMR instrument. While preparing the tube and until the NMR measurement, the operator should take care to avoid any evaporation of ethanol and TMU since this would cause isotopic fractionation, errors in the weights (m_A and m_{ST}) of the components and erroneous NMR results.

The correctness of the procedure of measurement including this preparation step can be checked using the CRM 656.

Note: the hexafluorobenzene can be added with 10% (v/v) of trifluoroacetic acid (5.1.3) in order to catalyze the fast hydrogen exchange on hydroxyle bond resulting in a single NMR peak for both the hydroxyle and residual water signals.

7.2 Recording of ^2H NMR spectra of the alcohol

The homogeneity of the magnetic field B_0 in the sample is optimized through the “shimming” procedure maximizing the ^{19}F NMR lock signal observed the hexafluorobenzene. Modern NMR spectrometers can perform automatically and efficiently this “shimming” procedure provided that the initial settings are close enough to the optimal magnetic field homogeneity for a given sample as is generally the case for a batch of ethanol samples prepared as described in 7.1. The efficiency of this procedure can be checked through the resolution measured on the spectrum obtained without exponential multiplication (i.e. $LB = 0$) (Figure 2b) and expressed by the half-width of the methyl and methylene signals of ethanol and the methyl signal of TMU, which must be less than 0.5 Hz in the best conditions. The sensitivity, measured with an exponential multiplying factor LB equal to 2 (Figure 2a) must be greater than or equal to 150 for the methyl signal of ethanol of alcoholic strength 95 % vol (93.5 % mas).

7.2.2 Checking the instrumental settings

Carry out customary standardization for homogeneity and sensitivity according to the manufacturer's specifications.

Use the sealed tubes CRM123 (H: High , M: Medium, L: Low).

COMPENDIUM OF INTERNATIONAL ANALYSIS OF METHODS - OIV
Determination of the deuterium distribution in ethanol by
SNIF-NMR

Following the procedure described below in 9.3, determine the isotope values of these alcohols, denoting them H_{meas} , M_{meas} , L_{meas} .

Compare them with the given corresponding standard values, denoted by a superscript H_{st} , M_{st} , L_{st} .

Typically, as an indication the standard deviation obtained for 10 repetitions of each spectrum should be of the order of 0.01 for the ratio R and 0.5 ppm for $(D/H)_I$ and 1 ppm for $(D/H)_{II}$.

The average values obtained for the various isotopic parameters (R , $(D/H)_I$, $(D/H)_{II}$) must be within the corresponding standard deviation of repeatability given for those parameters for the CRM123. If they are not, carry out the checks again.

Once the settings have been optimized also other CRM materials can be used to monitor the quality of measurements in routine analysis.

7.3 Conditions for obtaining NMR spectra

Place a sample of alcohol prepared as in 7.1 in a 10 mm tube and introduce it into the probe.

Suggested conditions for obtaining NMR spectra are as follows:

- a constant probe temperature, set to better less than $\pm 0.5^\circ\text{K}$ variation in the range 302 K to 306 K depending on the heating power generated by the decoupling;
- acquisition time of at least 6.8 s for 1200 Hz spectral width (16K memory) (i.e. about 20 ppm at 61.4 MHz or 27 ppm at 46.1 MHz);
- 90° pulse;
- parabolic detection: fix the offset 01 between the OD and CHD reference signals for ethanol and between the HOD and TMU reference signals for water;
- determine the value of the decoupling offset 02 from the proton spectrum measured by the decoupling coil on the same tube. Good decoupling is obtained when 02 is located in the middle of the frequency interval existing between the CH₃- and CH₂- groups. Use the wide band decoupling mode or

COMPENDIUM OF INTERNATIONAL ANALYSIS OF METHODS - OIV
Determination of the deuterium distribution in ethanol by
SNIF-NMR

composite pulse sequences (eg. WALTZ16) to ensure homogeneous decoupling on the whole spectrum.

For each spectrum, carry out a number of accumulations NS sufficient to obtain the signal-to-noise ratio indicated as sensitivity in 7.2 and repeat NE times this set of NS accumulations. The values of NS depend on the types of spectrometer and probe used. Examples of the possible choices are:

Spectrometer	10 mm probe
7.05 T	NS = 304
9.4 T	NS = 200

The number of repetitions NE should be statistically meaningful and sufficient to achieve the performance and precision of the method as reported below in §9.

In the case that two NMR sample tubes have been prepared following the procedure described in 7.1, five repetitions of NMR spectra (NE=5) can be recorded on each tube. The final result for each isotopic parameter corresponds to the mean value of the measurements obtained on the two NMR sample tubes. In that case, the acceptance criteria for validation of the results obtained with these two tubes are:

$$|\text{Mes1(D/H)}_I - \text{Mes2(D/H)}_I| < 0.5 \text{ ppm}, \quad |\text{Mes1(D/H)}_{II} - \text{Mes2(D/H)}_{II}| < 0.8 \text{ ppm}$$

Expression of results

For each of the NE spectra (see NMR spectrum for ethanol, Figure 2a), determine:

$$R = 3 \cdot \frac{h_{II}}{h_I} = 3 \cdot \frac{\text{height of signal II (CH}_3 \text{ CH}_D \text{ OH)}}{\text{height of signal I (CH}_2\text{D CH}_2 \text{ OH)}}$$

$$\left(\text{D/H}\right)_I = 1.5866 \cdot T_I \cdot \frac{m_{ST}}{m_A} \cdot \frac{\left(\text{D/H}\right)_{ST}}{t_m^D}$$

COMPENDIUM OF INTERNATIONAL ANALYSIS OF METHODS - OIV
Determination of the deuterium distribution in ethanol by
SNIF-NMR

$$\left(\text{D/H}\right)_{\text{II}} = 2.3799 \cdot T_{\text{II}} \cdot \frac{m_{\text{ST}}}{m_{\text{A}}} \cdot \frac{\left(\text{D/H}\right)_{\text{ST}}}{t_m^{\text{D}}}$$

with

- $T_{\text{I}} = \frac{\text{height of signal I (CH}_2\text{D CH}_2\text{ OH)}}{\text{height of signal of internal standard (TMU)}}$
- $T_{\text{II}} = \frac{\text{height of signal II (CH}_3\text{ CHD OH)}}{\text{height of signal of internal standard (TMU)}}$

- m_{ST} and m_{A} , see 7.1

- t_m^{D} , see 6.3

- $(\text{D/H})_{\text{ST}}$ = isotope ratio of internal standard (TMU) indicated on certificate delivered by IRMM.

The use of peak heights instead of peak area, which is less precise, supposes that peak width at half height is identical and is a reasonable approximation if applicable (Figure 2b).

For each of the isotope parameters, calculate the average and the confidence interval for the number of repeated spectra acquired on a given sample.

Optional softwares enable such calculations to be carried out on-line.

Precision

The repeatability and Reproducibility of the SNIF-NMR method has been studied through collaborative studies on fruit juices as reported in the bibliography here below. However these studies considered only the parameter $(\text{D/H})_{\text{I}}$. In the case of wine data from in-house studies carried out by several laboratories can be considered for establishing the standard deviation of repeatability and the limit of repeatability as presented in Annex I. The results of proficiency testing reported in Annex II provide data that can be used to compute the standard deviation of Reproducibility and the limit of Reproducibility for wines.

COMPENDIUM OF INTERNATIONAL ANALYSIS OF METHODS - OIV
Determination of the deuterium distribution in ethanol by
SNIF-NMR

These figures can be summarised as follows:

	(D/H) _I	(D/H) _{II}	R
S _r	0.26	0.30	0.005
r	0.72	0.84	0.015
S _R	0.35	0.62	0.006
R	0.99	1.75	0.017

with

- S_r : standard deviation of repeatability
- r : limit of repeatability
- S_R: standard deviation of reproducibility
- R : limit of Reproducibility

REFERENCES

- MARTIN G.J., MARTIN M.L., MABON F., *Anal. Chem.*, 1982, 54, 2380-2382.
- MARTIN G.J., MARTIN M.L., *J. Chim. Phys.*, 1983, 80, 294-297.
- MARTIN G.J., GUILLOU C., NAULET N., BRUN S., Tep Y., Cabanis J.C.,
CABANIS M.T., SUDRAUD P., *Sci. Alim.*, 1986, 6, 385-405.
- MARTIN G.J., ZHANG B.L., NAULET N. and MARTIN M.L., *J. Amer. Chem. Soc.*, 1986, 108, 5116-5122.
- MARTIN G.J., GUILLOU C., MARTIN M.L., CABANIS M.T., TEP Y. et AERNY J., *J. Agric. Food Chem.*, 1988, 36, 316.
- MARTIN G. G., WOOD R., MARTIN, G. J., *J. AOAC Int.*, 1996 , 79 (4), 917-928.
- MARTIN G.G., HANOTE V., LEES M., MARTIN Y-L.,. *J. Assoc Off Anal Chem*, 1996, 79, 62-72
- CRAIG H., *Science* , 1961, 133, 1702 - 1703

COMPENDIUM OF INTERNATIONAL ANALYSIS OF METHODS - OIV
Determination of the deuterium distribution in ethanol by
SNIF-NMR

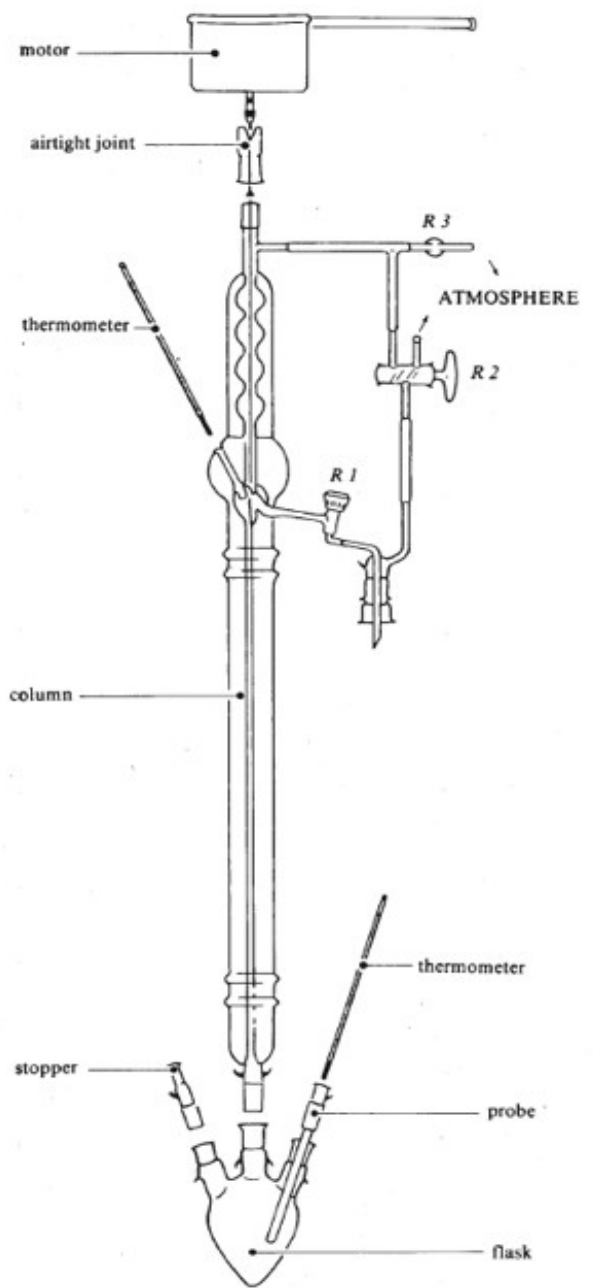

Figure 1 - Apparatus for extracting ethanol

COMPENDIUM OF INTERNATIONAL ANALYSIS OF METHODS - OIV
Determination of the deuterium distribution in ethanol by
SNIF-NMR

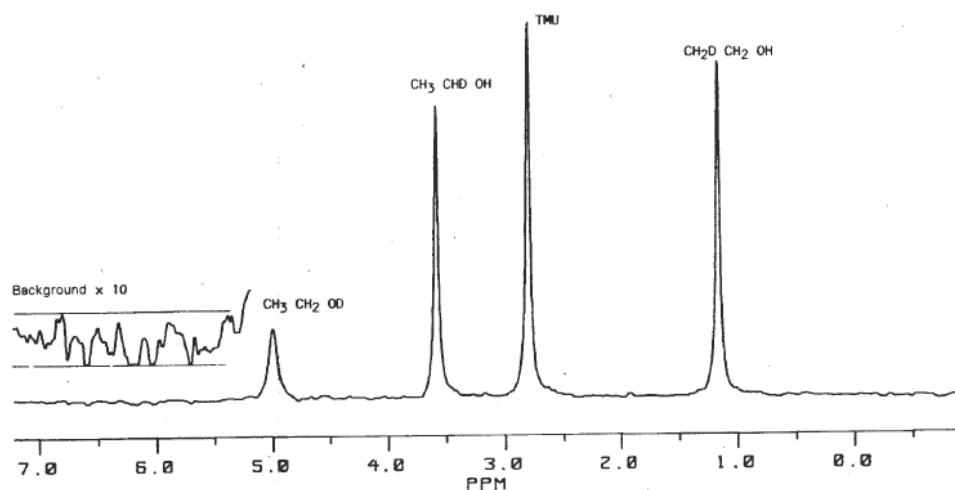

Figure 2a
 ^2H NMR spectrum of an ethanol from wine with an internal standard (TMU: N, N-tetramethylurea)

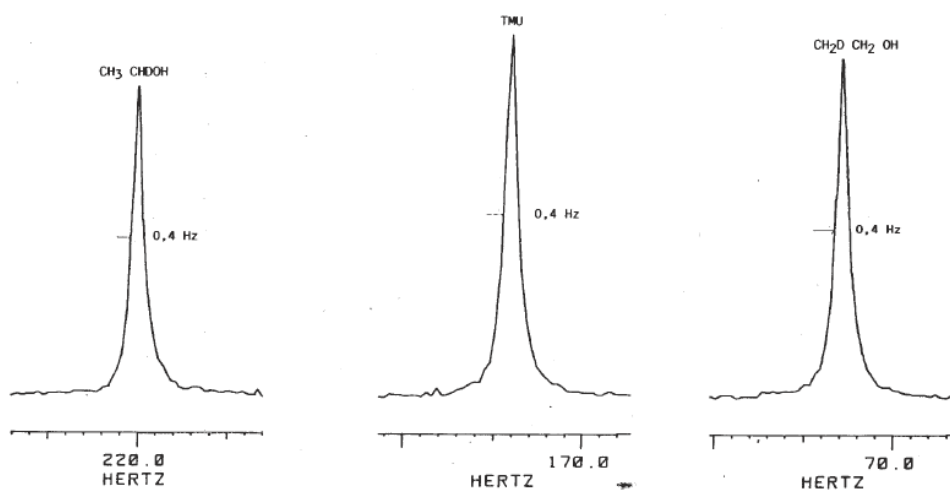

Figure 2b
 ^2H spectrum of ethanol taken under the same conditions as those of Figure 2a, but without exponential multiplication (LB = 0)

COMPENDIUM OF INTERNATIONAL ANALYSIS OF METHODS - OIV
Determination of the deuterium distribution in ethanol by
SNIF-NMR

Annex I: Estimation of the repeatability from in-house repeatability studies

The in-house repeatability studies performed in 4 laboratories provide data that allows the estimation of the repeatability of the SNIF-NMR method.

These in-house repeatability studies have been performed by duplicate distillations and measurements of 10, 9 or 15 different wine samples by the laboratories 1, 2 and 3.

Alternatively the laboratory 4 performed 16 distillations and measurements on the same wine in condition of repeatability on a short period of time.

Table I-1: lab 1 : 10 wines analysed in duplicates

Sample	$(D/H)_I$	$(D/H)_{II}$	R	$(D/H)_I$	$(D/H)_{II}$	$(D/H)_{II}$	R		
				abs	abs	abs	abs	$(\Delta(D/H)_{II})$	Squares
1	103.97	130.11	2.503	0.55	0.302	0.68	0.462	0.000	0.00000
	104.52	130.79	2.503						
2	103.53	130.89	2.529	0.41	0.168	0.32	0.102	0.016	0.00026
	103.94	130.57	2.513						
3	102.72	130.00	2.531	0.32	0.102	0.20	0.040	0.004	0.00002
	103.04	130.20	2.527						
4	105.38	132.39	2.513	0.14	0.020	0.20	0.040	0.000	0.00000
	105.52	132.59	2.513						
5	101.59	127.94	2.519	0.48	0.230	0.20	0.040	0.016	0.00026
	101.11	128.14	2.535						
6	103.23	132.14	2.560	0.30	0.090	0.36	0.130	0.001	0.00000

COMPENDIUM OF INTERNATIONAL ANALYSIS OF METHODS - OIV
Determination of the deuterium distribution in ethanol by
SNIF-NMR

	102.93	131.78	2.561						
7	103.68	130.95	2.526	0.15	0.023	0.75	0.563	0.011	0.00012
	103.53	130.20	2.515						
8	101.76	128.86	2.533	0.24	0.058	0.42	0.176	0.003	0.00001
	101.52	128.44	2.530						
9	103.05	129.59	2.515	0.04	0.002	0.44	0.194	0.007	0.00005
	103.01	129.15	2.508						
10	101.47	132.63	2.614	0.50	0.250	0.18	0.032	0.010	0.00010
	100.97	132.45	2.624						
				Sum of squares:	1.245		1.779		0.00081
				Sr	0.25		0.30		0.006
				r	0.71		0.84		0.018

COMPENDIUM OF INTERNATIONAL ANALYSIS OF METHODS - OIV
Determination of the deuterium distribution in ethanol by
SNIF-NMR

Table I-2: lab 2 : 9 wines analysed in duplicates

Sample	(D/H) _i	(D/H) _{ii}	R	(D/H)I	(D/H)II	R			
				abs	abs	abs	(Δ(D/H) _i)	Squares	(Δ(D/H) _{ii})
1	105.02	133.78	2.548	0.26	0.068	0.10	0.010	0.008	0.00007
	104.76	133.88	2.556						
2	102.38	130.00	2.540	0.73	0.533	0.40	0.160	0.010	0.00011
	101.65	129.60	2.550						
3	100.26	126.08	2.515	0.84	0.706	0.64	0.410	0.008	0.00007
	99.42	125.44	2.523						
4	101.17	128.83	2.547	0.51	0.260	0.45	0.203	0.004	0.00002
	100.66	128.38	2.551						
5	101.47	128.78	2.538	0.00	0.000	0.26	0.068	0.005	0.00003
	101.47	128.52	2.533						
6	106.14	134.37	2.532	0.12	0.014	0.04	0.002	0.002	0.00000
	106.26	134.41	2.530						
7	103.62	130.55	2.520	0.05	0.003	0.11	0.012	0.003	0.00001
	103.57	130.66	2.523						
8	103.66	129.88	2.506	0.28	0.078	0.55	0.302	0.004	0.00001
	103.38	129.33	2.502						
9	103.50	129.66	2.506	0.43	0.18	0.22	0.04	0.01	0.000
	103.93	129.44	2.491	5	5	8	8	5	21
Sum of squares:				1.84	1.21	0.000	6	4	53
Sr				0.32	0.26	0.005			
r				0.91	0.74	0.015			

COMPENDIUM OF INTERNATIONAL ANALYSIS OF METHODS - OIV
Determination of the deuterium distribution in ethanol by
SNIF-NMR

Table I-3: lab 3 : 15 wines analysed in duplicates

				(D/H)I abs ($\Delta(D/H)_i$)	Squares	(D/H)II abs ($\Delta(D/H)_i$)	Squares	R abs ($\Delta(R)$)	Squares
Sample	(D/H) _I	(D/H) _{II}	R						
1	101.63	125.87	2.477	0.06	0.004	0.46	0.212	0.007	0.00005
	101.57	125.41	2.470						
2	99.24	124.41	2.507	0.05	0.002	0.04	0.002	0.001	0.00000
	99.19	124.37	2.508						
3	101.23	125.07	2.471	0.06	0.004	0.16	0.026	0.005	0.00002
	101.17	125.23	2.476						
4	100.71	125.29	2.488	0.07	0.005	1.16	1.346	0.024	0.00058
	100.78	124.13	2.464						
5	99.89	124.02	2.483	0.18	0.032	0.56	0.314	0.007	0.00005
	99.71	123.46	2.476						
6	100.60	124.14	2.468	0.19	0.036	0.66	0.436	0.018	0.00032
	100.41	124.80	2.486						
7	101.47	125.60	2.476	0.23	0.053	0.14	0.020	0.003	0.00001
	101.70	125.74	2.473						
8	102.02	124.00	2.431	0.13	0.017	0.07	0.005	0.005	0.00002
	102.15	123.93	2.426						
9	99.69	124.60	2.500	0.40	0.160	0.53	0.281	0.000	0.00000
	100.09	125.13	2.500						
10	99.17	123.71	2.495	0.30	0.090	0.19	0.036	0.004	0.00002
	99.47	123.90	2.491						
11	100.60	123.89	2.463	0.40	0.160	0.54	0.292	0.001	0.00000
	101.00	124.43	2.464						
12	99.38	124.88	2.513	0.33	0.109	0.55	0.302	0.002	0.00000
	99.05	124.33	2.511						
13	99.51	125.24	2.517	0.44	0.194	0.01	0.000	0.011	0.00012
	99.95	125.25	2.506						
15	101.34	124.68	2.460	0.43	0.185	0.41	0.168	0.002	0.00000
	101.77	125.09	2.458						
			Sum of squares:		1.050		3.437		0.00120
			Sr		0.19		0.34		0.006
			r		0.53		0.96		0.018

COMPENDIUM OF INTERNATIONAL ANALYSIS OF METHODS - OIV
Determination of the deuterium distribution in ethanol by
SNIF-NMR

Table I-
4:

lab 4 : one wine analysed 16
times

Repetition	(D/H) _I	(D/H) _{II}	R	Variance	(D/H) _I	(D/H) _{II}	R
1	101.38	126.87	2.503	:	0.070	0.0840	0.00001
2	101.30	126.22	2.492		3		3
3	100.98	125.86	2.493	Sr	0.27	0.29	0.004
4	100.94	126.00	2.497				
5	100.71	125.79	2.498	r	0.75	0.82	0.010
6	100.95	126.05	2.497				
7	101.17	126.30	2.497				
8	101.22	126.22	2.494				
9	100.99	125.91	2.494				
10	101.29	126.24	2.493				
11	100.78	126.07	2.502				
12	100.65	125.65	2.497				
13	101.01	126.17	2.498				
14	100.89	126.05	2.499				
15	101.66	126.52	2.489				
16	100.98	126.11	2.498				

The pooled data for the standard deviation of repeatability and for the limit of repeatability can thus be estimated as:

	(D/H) _I	(D/H) _{II}	R
Sr	0.26	0.30	0.005
limit of repeatability r	0.72	0.84	0.015

COMPENDIUM OF INTERNATIONAL ANALYSIS OF METHODS - OIV
Determination of the deuterium distribution in ethanol by
SNIF-NMR

Data of in-house repeatability studies were provided by (in alphabetic order):

-Bundesinstitut für Risikobewertung,
Thielallee 88-92 PF 330013 D-14195 BERLIN – GERMANY

-Fondazione E. Mach-Istituto Agrario di San Michele all'Adige,
Via E. Mach, 1 - 38010 San Michele all'Adige (TN), ITALY

-Joint Research Centre - Institute for Health and Consumer Protection,
I-21020 ISPRA (VA) – ITALY

-Laboratorio Arbitral Agroalimentario, Carretera de la Coruña, km 10,7
E-28023 MADRID –SPAIN

Annex II: Evaluation of the Reproducibility from proficiency testing data

Since December 1994 international proficiency testing exercises on the determination of isotopic parameters on wine and various other food matrices have been regularly organised. These proficiency testing exercises allow participating laboratories to assess their performance and the quality of their analyses. The statistical exploitation of these results obtained on a large number of samples over a long period of time allows the appreciation of the variability of the measurements under conditions of reproducibility. This enables a good estimation of the variance parameters and of the reproducibility limit of the method. The results of 40 rounds of proficiency testing since 1994 until 2010 for various type of wine (red, white, rosé, dry, sweet and sparkling) are summarised in the table II-1 here below.

For $(D/H)_I$ and $(D/H)_{II}$ the pooled S_R can thus be calculated using the following equation:

COMPENDIUM OF INTERNATIONAL ANALYSIS OF METHODS - OIV
Determination of the deuterium distribution in ethanol by
SNIF-NMR

$$\sqrt{\frac{\sum_i^K (N_i - 1) S_{R,i}^2}{\sum_i^K (N_i - 1)}}$$

with N_i , and $S_{R,i}$ the number of values and the standard deviation of reproducibility of the i^{th} round, and K the number of rounds.

Considering the definition of the intramolecular ratio R , and applying the standard error propagation rules assuming that $(D/H)_I$ and $(D/H)_{II}$ are uncorrelated (the covariance terms are then zero), one can also estimate the standard deviation of Reproducibility for this parameter.

The following figures can thus be calculated:

	$(D/H)_I$	$(D/H)_{II}$	R
S_R :	0.35	0.62	0.006
Limit of Reproducibility R	0.99	1.75	0.01

Table II-1 : FIT Proficiency Testing – Summary of statistical values observed on wine samples:

Sample	Year	Round	N	Mean	S_R	N	Mean	S_R
Red wine	1994	R1	10	102.50	0.362	10	130.72	0.33
Rosé wine	1995	R1	10	102.27	0.333	10	128.61	0.35
Red wine	1995	R2	11	101.45	0.389	11	127.00	0.55
Red wine	1996	R1	11	101.57	0.289	11	132.23	0.34
Rosé wine	1996	R2	12	102.81	0.322	12	128.20	0.60
White wine	1996	R3	15	103.42	0.362	15	127.97	0.51
Red wine	1996	R4	15	102.02	0.377	13	131.28	0.30

COMPENDIUM OF INTERNATIONAL ANALYSIS OF METHODS - OIV
Determination of the deuterium distribution in ethanol by
SNIF-NMR

Rosé wine	1997	R1	16	103.36	0.247	16	126.33	0.44
White wine	1997	R2	16	103.42	0.444	15	127.96	0.53
Sweet White Wine	1997	R2	14	99.16	0.419	15	130.02	0.88
Wine	1997	R3	13	101.87	0.258	15	132.03	0.61
Sweet Wine	1997	R3	12	102.66	0.214	12	128.48	0.48
Rosé wine	1997	R4	16	102.29	0.324	16	129.29	0.63
Sweet Wine	1997	R4	15	102.04	0.269	13	131.27	0.30
White wine	1998	R1	16	105.15	0.302	16	127.59	0.59
Sweet Wine	1998	R3	16	102.17	0.326	16	129.60	0.56
Red wine	1998	R4	17	102.44	0.306	17	131.60	0.47
White wine	1999	R1	14	102.93	0.404	13	129.64	0.46
Sweet Wine	2000	R2	15	103.19	0.315	14	129.43	0.60
Wine	2001	R1	12	105.28	0.264	16	131.32	0.68
Sweet Wine	2001	R2	14	101.96	0.249	15	128.99	1.05
Wine	2002	R1	17	101.01	0.365	16	129.02	0.74
Wine	2002	R2	17	101.30	0.531	17	129.28	0.93
Wine	2003	R1	18	100.08	0.335	18	128.98	0.77
Sweet Wine	2003	R2	17	100.51	0.399	18	128.31	0.80
Wine	2004	R1	18	102.88	0.485	19	128.06	0.81
Sweet Wine	2004	R3	16	101.47	0.423	16	130.10	0.71
Wine	2005	R1	19	101.33	0.447	19	129.88	0.76
Sweet wine	2005	R2	15	102.53	0.395	15	131.36	0.38
Dry wine	2006	R1	18	101.55	0.348	18	131.30	0.51
Sweet wine	2006	R2	18	100.31	0.299	18	127.79	0.55
Wine	2007	R1	18	103.36	0.403	18	130.90	0.90
Sweet wine	2007	R2	19	102.78	0.437	19	130.72	0.55
Wine	2008	R1	24	103.20	0.261	23	131.29	0.59
Sweet wine	2008	R2	20	101.79	0.265	19	129.73	0.34
Dry wine	2009	R1	24	102.96	0.280	23	130.25	0.49
Sweet wine	2009	R2	21	101.31	0.310	21	127.07	0.50
Dry wine	2010	R1	21	101.80	0.350	20	129.65	0.40
Sparkling wine	2010	R1	11	101.51	0.310	11	129.09	0.68
Dry wine	2010	R2	20	104.05	0.290	19	133.31	0.58

**Determination of polyols derived from sugars and residual
sugars found in dry wines by means of gas chromatography**

(Resolution OENO 9/2006 ; OIV/OENO 377/2009)

1. Scope

Simultaneous determination of the erythritol, arabitol, mannitol, sorbitol and meso-inositol content of wines.

Because the determination of sugars by gas chromatography (GC) is long and complicated, it is reserved for the determination of traces of sugars and, especially, of sugars for which no other routine enzyme method exists – (Arabinose, Rhamnose, Mannose and Galactose) although it is also applicable to glucose and fructose, the advantage being that it is possible to simultaneously determine all sugar monomers, dimers and even trimers.

Comment 1 - It is not possible to determine sugars once they have been reduced to alditol form because of the presence of corresponding polyols.

Comment 2 - In the form of trimethylsilylated derivatives (TMS), sugars give 2 α and β forms and occasionally 3 or 4 (Gamma...) corresponding to the different anomers present in wines.

Comment 3 - Without prior dilution, it is difficult to determine glucose and fructose content using this method when it exceeds 5 g/l.

2. Principle

Residual sugars in dry wines can be determined by gas chromatography after the formation of their trimethylsilylated derivatives.

The internal standard is pentaerythritol.

3. Reagents

Silane mixture for example purposes:

3.1 Pure hexamethyldesilazane (HMDS)

3.2 Pure trifluoroacetic anhydride (TFA)

3.3 Pure pyridine

3.4 Pure pentaerythritol

COMPENDIUM OF INTERNATIONAL ANALYSIS OF METHODS - OIV

Polyols derived from sugars

3.5. Distilled water

3.6 10 g/l pentaerythritol (internal standard solution): dissolve 0.15 g of pentaerythritol (3.4) in 100 ml of water (3.5)

3.7 Pure products that may be used to prepare control solutions, notably glucose, fructose, arabinose, mannitol and sorbitol (non-exhaustive list)

3.8 Control solutions of pure products at 200 mg/l: dissolve 20 mg of each of the products to be determined (3.6) in 100 ml of water.

Comment – Sugar solutions should be prepared immediately prior to use.

4. Apparatus and Equipment

4.1 1-ml pipettes, with 1/10th ml graduations

4.2 Propipette™ bulbs

4.3 100-μl syringe

4.4 5-ml tubes with screw stoppers fitted with a Teflon-coated sealing cap.

4.5 Rotary vacuum evaporator capable of housing screw-cap test tubes (4.4) in order to evaporate samples to dryness

4.6 Gas chromatograph fitted with a flame ionisation detector x g, and an injector operating in "split" mode - 1/30th to 1/50th division of the injected volume (1 μl)

4.7 Non-polar capillary column (SE-30, CPSil-5, HP-1, etc.) 50 m x 0.25 mm, 15 μm stationary phase film thickness (as an example).

4.8 10-μl injection syringe

4.9 Data acquisition system

4.10 Ultra-sonic bath

4.11 Laboratory fume cupboard

5. Preparation of samples

5.1 Addition of the internal standard: 1 ml of wine (pipette, 4.1) or of 200 mg/l control solution (3.6) is placed in the screw-cap test tube (4.4)

Note: It is possible to operate with lower volumes of wine especially in high content sugar environments.

50 μl of the 10 g/l pentaerythritol solution (3.5) is added by means of the syringe (4.3)

5.2 Obtaining dry solid matter:

The screw-cap test tube is placed on the rotary evaporator, with a water bath kept below 40°C. Evaporation continues until all traces of liquid have disappeared.

5.3 Addition of reagents

COMPENDIUM OF INTERNATIONAL ANALYSIS OF METHODS - OIV

Polyols derived from sugars

5.3.1 Place the tubes containing the dry solid matter and reagents 3.1, 3.2 and 3.3 in the fume cupboard (4.11) and switch on the ventilation.

5.3.2 Using the pipettes (4.1) and Propipette™ bulbs (4.2), add 0.20 ml of pyridine (3.3), 0.7 ml of HMDS (3.1) and 0.1 ml of TFA (3.2) to the test tube one after the other.

5.3.3 Seal the test tube with its stopper.

5.3.4 Put the test tube in the ultra-sonic bath (4.10) for 5 minutes until the dry solid matter has completely dispersed.

5.3.5 Place the test tube in a laboratory kiln at 60°C for two hours in order to obtain the total substitution of the hydroxyl or acid hydrogen by the trimethylsilyl groups (TMS).

Comment: a single phase only should remain after heating (if not, water would be left in the test tube). Likewise, there should be no brownish deposit, which would indicate an excess of non-derived sugar.

6 Chromatographic assay

6.1 Place the cooled test tube in the ventilated fume cupboard (4.11), remove 1 µl with the syringe (4.8) and inject into the chromatograph in "split" mode (permanent split).

Treat the wine-derived and control sample in the same way.

6.2 Programme the kiln temperature, for example from 60°C to 240°C at a rate of 3°C per minute, such that the complete assay lasts, for example, one hour for complete mannitol and sorbitol separation (resolution higher than 1.5).

7. Calculations

Example: calculation of sorbitol concentration

If

s = the peak area of the sorbitol in the wine

S = the peak area of the sorbitol in the control solution

i = the peak area of the internal standard in the wine

I = the peak area of the internal standard in the control solution

The sorbitol content of the wine (ts) will be

$$ts = 200 \times \frac{s}{S} \times \frac{I}{i} \quad \text{in mg per litre}$$

The same logic makes it possible to calculate the glucose content (tg)

**COMPENDIUM OF INTERNATIONAL ANALYSIS OF METHODS -
OIV**

Polyols derived from sugars

$$tg = 200 \times \frac{g}{G} \times \frac{l}{i} \quad \text{in mg per litre}$$

when g is the sum of the areas of the two peaks of glucose in the wine and G is the sum of the areas of the two peaks of glucose in the control solution.

8. Characteristics of the method

Detection threshold approximately 5 mg/l for a polyol (a single chromatographic peak). Average repeatability in the region of 10% for a sugar or polyol concentration in the region of 100 mg/l.

Table 1 Repeatability of the determination of a number of substances found in the dry solid matter of wine after TMS derivatization.

	Tartaric acid	Fructose	Glucose	Mannitol	Sorbitol	Dulcitol	Meso-inositol
Average (mg/l)	2013	1238	255	164	58	31	456
Typical variance(mg/l)	184	118	27	8	2	2	28
CV (%)	9	10	11	5	3	8	6

**COMPENDIUM OF INTERNATIONAL ANALYSIS OF METHODS -
OIV
Polyols derived from sugars**

REFERENCES

RIBEREAU-GAYON P. and BERTRAND A. 1972, Nouvelles applications de la chromatographie en phase gazeuse à l'analyse des vins *et* au contrôle de leur qualité, *Vitis*, 10, 318-322.

BERTRAND A. (1974), Dosage des principaux acides du vin par chromatographie en phase gazeuse. *FV OIV* 717—718, 253—274.

DUBERNET M.O. (1974), Application de la chromatographie en phase gazeuse à l'étude des sucres et polyols du vin: thèse 3^o Cycle, Bordeaux.

**COMPENDIUM OF INTERNATIONAL ANALYSIS OF METHODS -
OIV
Polyols derived from sugars**

Figure 1

Chromatogram of a white wine following silylation. CPSil-5CB 50 m x 0.25 mm x 0.15 µm column. Split injection, 60°C, 3°C/min, 240°C. Magnification below.

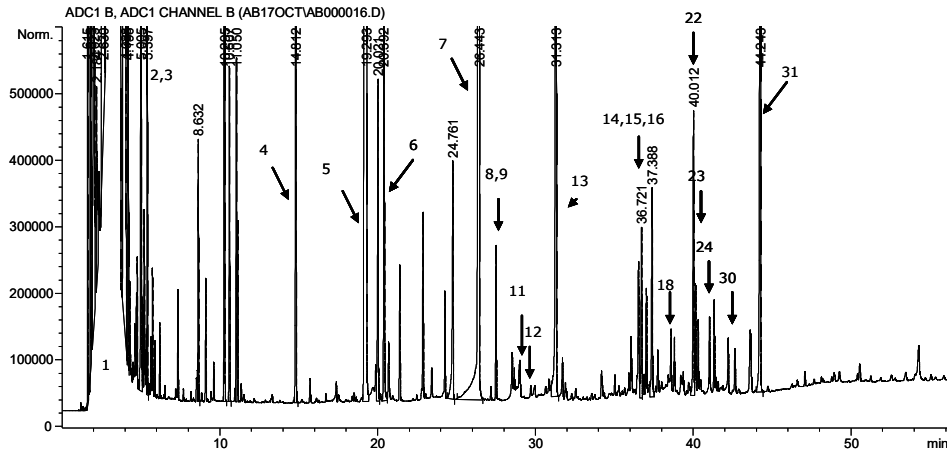

Identification of peaks: 1 : reactive mixture; 2 and 3: unknown acids; 4: pentaerythriol; 5 and 6: unknown; 7: tartaric acid and arabinose; 8, 10 and 11: rhamnose; 9: arabinose; 12: xylitol; 13: arabitol; 14, 15 and 16: fructose; 17: galactose and unknown; 18: glucose α; 19: galactose and galacturonic acid; 20 and 21: unknown; 22: mannitol; 23: sorbitol; 24: glucose β; 25 and 27: unknown; 26: galacturonic acid; 28 and 30: galactonolactone; 29: mucic acid; 31: meso-inositol.

Chromatogram of a white wine following silylation. CPSil-5CB 50 m x 0.25 mm x 0.15 µm column. Split injection, 60°C, 3°C/min, 240°C. Magnification below.

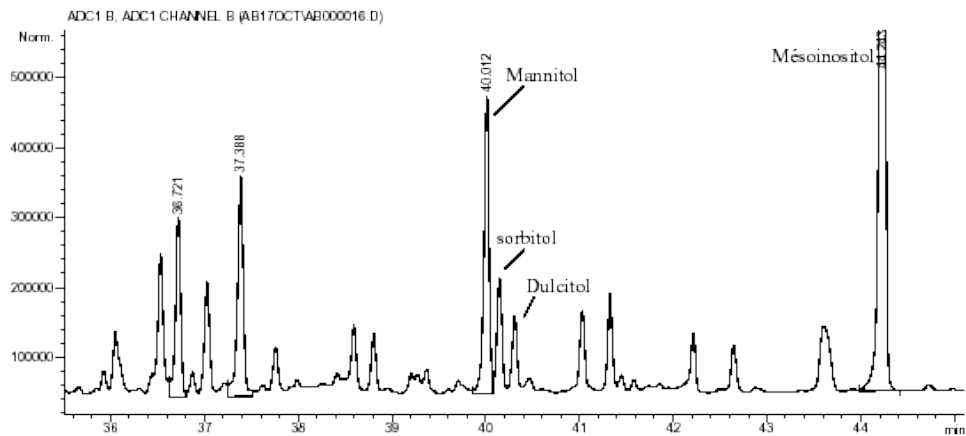

**Joint determination of the glucose and fructose content in
wines by differential ph-metry**

(Resolution OENO 10/2006 ; OIV/OENO 377/2009)

1. SCOPE

This method is applicable to the analysis of glucose and fructose in wines between 0 and 60 g/L (average level) or 50 and 270 g/L (high level).

2. PRINCIPLE

The joint determination of glucose and fructose content by differential pH-metry consists in the phosphorylation of the glucose and fructose by hexokinase. The H⁺ ions generated stoichiometrically in relation to the quantities of glucose and fructose are then quantified.

3. REACTIONS

The glucose and fructose present are phosphorylated by adenosine triphosphate (ATP) during an enzymatic reaction catalysed by hexokinase (HK) (EC. 2.7.1.1)

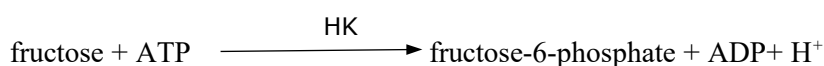
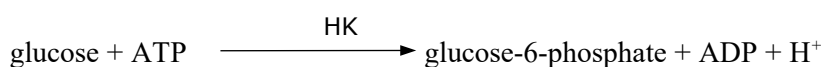

4. REAGENTS

4.1 Demineralised Water (18 MΩ) or bi-distilled

4.2 2-Amino-2-(hydroxymethyl)propane-1,3-diol (TRIS) purity ≥ 99%

4.3 Disodic adenosine triphosphate (ATP, 2Na) purity ≥ 99%

4.4 Trisodium phosphate with twelve water molecules (Na₃PO₄·12H₂O) purity ≥ 99%

4.5 Sodium hydroxide (NaOH) purity ≥ 98%

**COMPENDIUM OF INTERNATIONAL ANALYSIS OF METHODS -
OIV**

Glucose and fructose by differential pH-metry

4.6 Magnesium chloride with six water molecules ($\text{MgCl}_2 \cdot 6\text{H}_2\text{O}$) purity $\geq 99\%$

4.7 Triton X 100

4.8 Potassium chloride (KCl) purity $\geq 99\%$

4.9 2-Bromo-2-nitropropane-1,3-diol (Bronopol) ($\text{C}_3\text{H}_6\text{BrNO}_4$)

4.10 Hexokinase (EC. 2.7.1.1) 1 mg \cong 145 U (e.g. Hofmann La Roche, Mannheim, Germany ref. Hexo-70-1351)

4.11 Glycerol purity $\geq 98\%$

4.12 Glucose purity $\geq 99\%$

4.13 Reaction buffer pH 8.0 commercial or prepared according to the following method:

In a graduated 100-ml flask (5.2) pour roughly 70 ml (5.3) of water (4.1), and continuously stir (5.5). Add 0.242 g \pm 0.001 g (5.4) of TRIS (4.2), 0.787 g \pm 0.001 g (5.4) of ATP (4.3), 0.494 g \pm 0.001 g (5.4) of sodium phosphate (4.4), 0.009 mg \pm 0.001 g (5.4) of sodium hydroxide (4.5), 0.203 g \pm 0.001 g (5.4) of magnesium chloride (4.6), 2.000 \pm 0.001 g (5.4) of Triton X 100 (4.7), 0.820 g \pm 0.001 g (5.4) of potassium chloride (4.8) and 0.010 \pm 0.001 g (4.9) of bronopol. Adjust to volume with water (4.1). The final pH must be 8.0 \pm 0.1 (5.6), otherwise adjust it with sodium hydroxide or hydrochloric acid. The buffer thus prepared is stable for two months at 4°C.

4.14 Enzyme solution commercial or prepared according to the following method: Using a graduated pipette (5.7) place 5 ml of glycerol (4.11) into a graduated 10-ml flask, adjust to volume with water (4.1) and homogenize. Dissolve 20 mg \pm 1 mg (5.4) of hexokinase (4.10) and 5 mg of Bronopol (4.9) in 10 ml of the glycerol solution. The activity of the enzyme solution must be 300 U \pm 50 U per ml for the hexokinase. The enzyme solution is stable for 6 months at 4°C.

4.15 Preparation of the calibration solution (average level) if the supposed content is less than 50 g/L of glucose + fructose)

Place 3.60 g \pm 0.01 g (5.4) of glucose (4.12) (desiccated 12 hours beforehand at 40 °C until constant weight), 0.745 g \pm 0.001 g (5.4) of potassium chloride (4.8) and 0.010 g \pm 0.001 g of bronopol (4.9) in a graduated 100-ml flask (5.2). Add water (4.1). Fully homogenize (5.5). Adjust to volume with water (4.1) after removing the magnetic bar. The final concentration is 36 g/L of glucose. The solution is stable for 6 months at 4 °C.

**COMPENDIUM OF INTERNATIONAL ANALYSIS OF METHODS -
OIV
Glucose and fructose by differential pH-metry**

4.16 Preparation of the calibration solution (high level) if the supposed content is above 50 g/L of glucose + fructose)

Place 18.0 g \pm 0.01 g (5.4) of glucose (4.12) (desiccated 12 hours beforehand at 40 °C until constant weight), 0.745 g \pm 0.001 g (5.4) of potassium chloride (4.8) and 0.010 g \pm 0.001 g of bronopol (4.9) in a graduated 100-ml flask (5.2). Add water (4.1). Fully homogenize (5.5). Adjust to volume with water (4.1) after removing the magnetic bar. The final concentration is 180 g/L of glucose. The solution is stable for 6 months at 4°C.

5. APPARATUS

5.1 Differential pH-metry apparatus (EUROCHEM CL 10 plus, Microlab EFA or equivalent) see appendix A

5.2 Graduated 100-ml flask, class A

5.3 Graduated 100-ml test-tube with sole

5.4 Precision balance to weigh within 1 mg

5.5 Magnetic stirrer and magnetic Teflon bar

5.6 pH-meter

5.7 Graduated 3-mL, 5-mL pipettes, class A

5.8 Graduated 10-ml flask, class A

5.9 Automatic syringe pipettes, 25 and 50 μ L

6. PREPARATION OF SAMPLES

The samples should not be too charged with suspended matter; in the contrary case, centrifuge or filter them. Sparkling wines must be degassed.

7. PROCEDURE

The operator must respect the instructions for use of the equipment (5.1). Before any use, the instrument must be stabilized in temperature. The circuits must be rinsed with the buffer solution (4.13) after cleaning, if required.

**COMPENDIUM OF INTERNATIONAL ANALYSIS OF METHODS -
OIV
Glucose and fructose by differential pH-metry**

7.1 Determination of the blank (determination of the enzyme signal)

Fill the electrode compartments (EL₁ and EL₂) of the differential pH-meter (5.1) with the buffer solution (4.13); the potential difference between the two electrodes (D₁) must range between ± 150 mpH;

Add 24 µL of enzyme solution (4.14) to the reaction vessel (using the micropipette 5.9 or the preparer) and fill electrode EL₂;

Measure the potential difference (D₂) between the two electrodes;

Calculate the difference in pH, ΔpH₀ for the blank using the following formula:

$$\Delta\text{pH}_0 = D_2 - D_1$$

where

ΔpH₀ = the difference in pH between two measurements for the blank;

D₁ = the value of the difference in pH between the two electrodes filled with the buffer solution;

D₂ = the value of the difference in pH between the two electrodes, one of which is filled with the buffer solution and the other with the buffer solution and enzyme solution.

The value of ΔpH₀ is used to check the state of the electrodes during titration as well as their possible drift over time; it must lie between –30 and 0 mpH and ≤ 1.5 mpH between two consecutive readings. If not, check the quality of the buffer pH and the cleanliness of the hydraulic system and electrodes, clean if necessary and then repeat the blank.

7.2 Calibration

7.2.1 Average level

Fill the electrode compartments (EL₁ and EL₂) with the buffer solution (4.13);

Add 25 µL (with the micropipette 5.9 or the preparer) of the standard glucose solution (4.15) to the reaction vessel;

Fill the electrodes EL₁ and EL₂ with the buffer + standard solution;

Measure the potential difference (D₃) between the two electrodes;

Add 24 µL of enzyme solution (4.14) and fill electrode EL₂ with the buffer + standard solution + enzyme;

After the time necessary for the enzymatic reaction, measure the potential difference (D₄) between the two electrodes;

Calculate the difference in pH, ΔpH_c for the calibration sample using the following formula:

$$\Delta\text{pH}_c = (D_4 - D_3) - \Delta\text{pH}_0$$

where

**COMPENDIUM OF INTERNATIONAL ANALYSIS OF METHODS -
OIV**

Glucose and fructose by differential pH-metry

ΔpH_c = the difference between two measurements D_3 and D_4 for the calibration sample minus the difference obtained for the blank;

D_3 = the value of the difference in pH between the two electrodes filled with the reference buffer/solution mixture;

D_4 = the value of the difference in pH between the two electrodes, one of which is filled with the reference buffer/solution and the other with the buffer/ enzyme / reference solution.

Calculate the slope of the calibration line:

$$s = C_u / \Delta\text{pH}_c$$

where

C_u is the concentration of glucose in the standard solution expressed in g/L.

Check the validity of the calibration by analysing 25 μL of standard solution (ML) of glucose (4.15) according to the procedure (7.3). The result must range between $\pm 2\%$ of the reference value. If not, repeat the calibration procedure.

7.2.2 High level

Fill the electrode compartments (EL_1 and EL_2) with the buffer (4.13);

Add 10 μL (with the micropipette 5.9 or the preparer) of standard solution (HL) of glucose (4.16) to the reaction vessel;

Fill the electrodes EL_1 and EL_2 with the buffer + standard solution mixture;

Measure the potential difference (D_3) between the two electrodes;

Add 24 μL of enzyme solution (4.14) and fill electrode EL_2 with the buffer + standard solution + enzyme mixture;

After the time required for the enzymatic reaction, measure the potential difference (D_4) between the two electrodes;

Calculate the difference in pH, ΔpH_c for the calibration sample using the following formula:

$$\Delta\text{pH}_c = (D_4 - D_3) - \Delta\text{pH}_o$$

**COMPENDIUM OF INTERNATIONAL ANALYSIS OF METHODS -
OIV**

Glucose and fructose by differential pH-metry

where

ΔpH_c = the difference in pH between two measurements D_3 and D_4 for the calibration sample minus the difference obtained for the blank;

D_3 = the value of the difference in pH between the two electrodes filled with the buffer/ reference solution mixture;

D_4 = the value of the difference in pH between the two electrodes, one of which is filled with the buffer/ reference solution and the other with the buffer/ reference solution /enzyme.

Calculate the slope of the calibration line:

$$s = C_u/\Delta\text{pH}_c$$

where

C_u is the concentration of glucose in the standard solution expressed in g/L.

Check the validity of the calibration by analysing 10 μL of standard solution of glucose (4.16) in accordance with procedure (7.3). The result must range between $\pm 2\%$ of the reference value. If not, repeat the calibration procedure.

7.3 Quantification

Fill the electrode compartments (EL_1 and EL_2) with the buffer solution (4.13)

Add 10 μL (high level) or 25 μL (mean level) (with the micropipette 5.9 or the preparer) of the sample solution to the reaction vessel;

Fill electrodes EL_1 and EL_2 with the buffer + sample mixture;

Measure the potential difference (D_5) between the two electrodes;

Add 24 μL of the enzyme solution (4.14) and fill electrode EL_2 with the buffer mixture + sample + enzyme;

Measure the potential difference (D_6) between the two electrodes;

Calculate the quantity of aqueous solution in the sample using the following formula:

$$w = s \times [(D_6 - D_5) - \Delta\text{pH}_c]$$

where

w = the quantity of aqueous solution in the sample (in g/L);

s is the slope determined by the calibration line;

ΔpH_c = the difference in pH between two measurements for the blank;

D_5 = the value of the difference in pH between the two electrodes filled with the sample/ reference solution;

COMPENDIUM OF INTERNATIONAL ANALYSIS OF METHODS - OIV

Glucose and fructose by differential pH-metry

D_6 = the value of the difference in pH between the two electrodes, one of which is filled with the buffer/sample and the other with the buffer/ sample /enzyme.

8 EXPRESSION OF RESULTS

The results are expressed in g/L of glucose + fructose with one significant figure after the decimal point.

9 PRECISION

The details of the interlaboratory test on the precision of the method are summarized in appendix B.

9.1 Repeatability

The absolute difference between two individual results obtained in an identical matter tested by an operator using the same apparatus, in the shortest interval of time possible, shall not exceed the repeatability value r in 95% of the cases.

The value is: $r = 0.021x + 0.289$ where x is the content in g/L of glucose + fructose

9.2 Reproducibility

The absolute difference between two individual results obtained with an identical matter tested in two different laboratories, shall not exceed the reproducibility value of R in 95% of the cases.

The value is: $R = 0.033x + 0.507$ where w is the content in g/L of glucose + fructose

10 OTHER CHARACTERISTICS OF THE ANALYSIS

10.1 Detection and quantification limits

10.1.1 Detection limit

The detection limit is determined by using 10 series of three repetitions of an analytical blank and linear regression carried out with the wines of the precision test; it is equal to three standard deviations. In this case, the method gave as a result a detection limit of 0.03 g/L. Tests by successive dilutions confirmed this value.

**COMPENDIUM OF INTERNATIONAL ANALYSIS OF METHODS -
OIV
Glucose and fructose by differential pH-metry**

10.1.2 Quantification limit

The quantification limit is determined by using 10 series of three repetitions of an analytical blank and linear regression carried out with the wines of the precision test; it is equal to ten standard deviations. In this case, the method gave as a result a quantification limit of 0.10 g/L. Tests by successive dilutions confirmed this value. The quantifications of white and red wine carried out by the laboratories that took part in the interlaboratory analysis also confirm these figures.

10.2 Accuracy

Accuracy is evaluated based on the average coverage rate calculated for the loaded wines analysed double-blind during the interlaboratory test (wines A, B, C, D, F and J). It is equal to 98.9% with a confidence interval of 0.22%.

11. QUALITY CONTROL

Quality controls can be carried out with certified reference materials, wines whose characteristics have been determined by consensus, or loaded wines regularly used in analytical series, and by following the related control charts.

**COMPENDIUM OF INTERNATIONAL ANALYSIS OF METHODS -
OIV
Glucose and fructose by differential pH-metry**

Appendix A

Diagram of the differential pH-metry apparatus

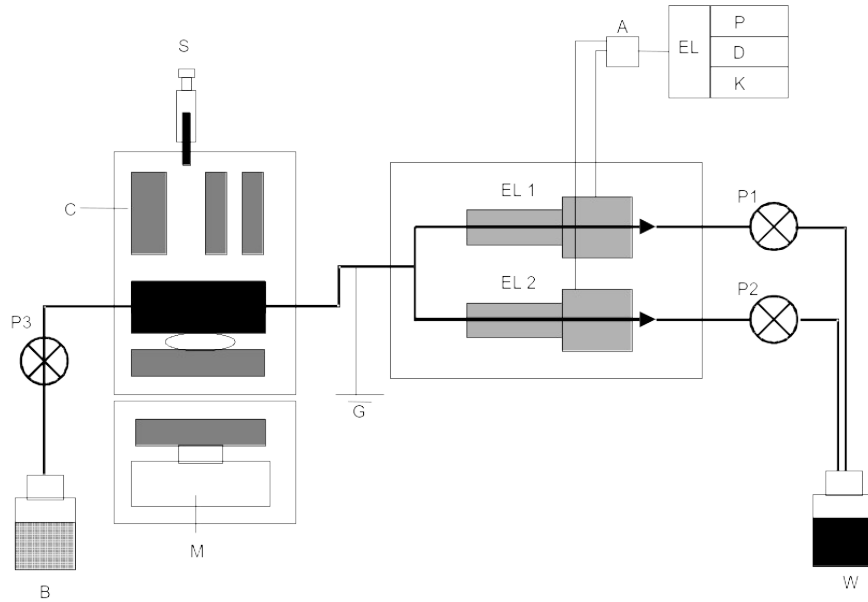

A: differential amplifier; B: buffer solution; C: mixing chamber; D: indicator; EL₁ and EL₂ capillary electrodes; EL: electronics; G: ground; K: keyboard; M: magnetic stirrer; P: printer; P₁ to P₃: peristaltic pumps; S: injection syringe for the sample and enzyme; W: waste.

**COMPENDIUM OF INTERNATIONAL ANALYSIS OF METHODS -
OIV**

Glucose and fructose by differential pH-metry

Appendix B

Statistical data obtained with the interlaboratory test results

In accordance with ISO 5725-2:1994, the following parameters were defined during an interlaboratory test. This test was carried out by the laboratory of the Inter-trade Committee for Champagne Wine in Epernay (France).

Year of the interlaboratory test: 2005

Number of laboratories: 13 double blind

Number of samples: 10

	Wine A	Wine B	Wine C	Wine D	Wine E	Wine F	Wine G	Wine H	Wine I	Wine J
Average in g/L	8.44	13.33	18.43	23.41	28.03	44.88	86.40	93.34	133.38	226.63
Number of laboratories	13	13	13	13	13	13	13	13	13	13
Number of laboratories after elimination of greatest dispersions	13	13	13	13	13	13	13	13	13	13
Standard deviation of repeatability	0.09	0.13	0.21	0.21	0.29	0.39	0.81	0.85	1.19	1.51
Repeatability limit	0.27	0.38	0.61	0.62	0.86	1.14	2.38	2.51	3.52	4.45
RSD _r , 100%	1.08	0.97	1.13	0.91	1.04	0.86	0.94	0.91	0.89	0.67
HORRAT _r	0.26	0.25	0.31	0.26	0.30	0.27	0.32	0.32	0.33	0.47
Standard deviation of reproducibility	0.17	0.27	0.37	0.59	0.55	0.45	1.27	1.43	1.74	2.69
Reproducibility limit	0.50	0.79	1.06	1.71	1.60	1.29	3.67	4.13	5.04	7.78
RSD _R , 100%	2.05	2.05	1.99	2.54	1.97	1.00	1.47	1.53	1.31	1.19
HORRAT _R	0.50	0.54	0.55	0.72	0.58	0.31	0.51	0.53	0.48	0.47

Types of samples:

**COMPENDIUM OF INTERNATIONAL ANALYSIS OF METHODS -
OIV**

Glucose and fructose by differential pH-metry

Wine A: white wine naturally containing sugar, loaded with 2.50 g/L glucose and of 2.50 g/L of fructose;

Wine B: white wine naturally containing sugar (wine A), loaded with 5.00 g/L glucose and 5.00 g/L of fructose;

Wine C: white wine naturally containing sugar (wine A), loaded with 7.50 g/L glucose and 7.50 g/L of fructose;

Wine D: white wine naturally containing sugar (wine A), loaded with 10.0 g/L glucose and 10.0 g/L of fructose;

Wine E: aromatised wine;

Wine F: white wine naturally containing less than 0.4 g/L of sugar, loaded with 22.50 g/L glucose and 22.50 g/L of fructose;

Wine G: naturally sweet red wine;

Wine H: sweet white wine;

Wine I: basis wine;

Wine J: white wine naturally containing less than 0.4 g/L of sugar, loaded with 115.00 g/L glucose and 115.00 g/L of fructose;

BIBLIOGRAPHY

LUZZANA M., PERELLA M. and ROSSI-BERNARDI L (1971): Anal. Biochem, 43, 556-563.

LUZZANA M., AGNELLINI D., CREMONESI P. and CARAMENTI g. (2001): Enzymatic reactions for the determination of sugars in food samples using the differential pH technique. Analyst, 126, 2149 –2152.

LUZZANA M., LARCHER R., MARCHITTI C. V. and BERTOLDI D. (2003): Quantificazione mediante pH-metria differenziale dell'urea negli spumanti metodo classico.in "Spumante tradizionale e classico nel terzo millennio" 27-28 giugno 2003, Istituti Agrario di San Mechele.

MOSCA A., DOSSI g., LUZZANA M., ROSSI-BERNARDI L., FRIAUF W. S., BERGER R.L., HOPKINS H. P. and CAREY V (1981): Improved apparatus for the differential measurement of pH: application to the measurement of glucose. Anal. Biochem., 112, 287 – 294.

MOIO L., GAMBUTI A., Di MARZIO L. and PIOMBINO P. (2001): Differential pHmeter determination of residual sugars in wine. Am. J. Enol. Vitic, 52(3), 271 – 274.

TUSSEAU D., FENEUIL A., ROUCHAUSSE J.M. et VAN LAER S. (2004): Mesure différents paramètres d'intérêt œnologiques par pHmétrie différentielle. FV. OOIV 1199, 5 pages.

Method OIV-MA-AS311-08

Type IV method

**Whole determination of glucose, fructose and saccharose
content in wines by differential ph-metry**

(Resolution OENO 11/2006 ; OIV/OENO 377/2009)

1. SCOPE

This method is applicable to the analysis of glucose and fructose in wines between 0 and 270 g/L.

This quantification is different from glucose and fructose quantification by its differential pH-metry which can not be substituted.

2. PRINCIPLE

The determination by differential pH-metry of glucose, fructose and saccharose content consists in the preliminary hydrolysis of saccharose by invertase, followed by phosphorylation of the glucose and fructose by hexokinase. The H⁺ ions generated stoichiometrically in relation to the quantities of glucose and fructose are then quantified.

3. REACTIONS

Possible traces of saccharose are hydrolysed by invertase (EC 3.2.1.26)

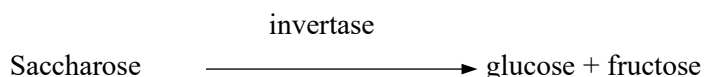

The glucose and fructose initially or consecutively present to invertase action are phosphorylated by adenosine triphosphate (ATP) during an enzymatic reaction catalysed by hexokinase (HK) (EC. 2.7.1.1)

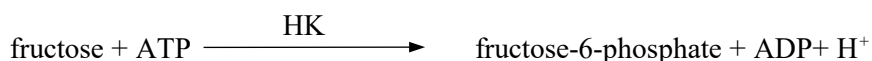
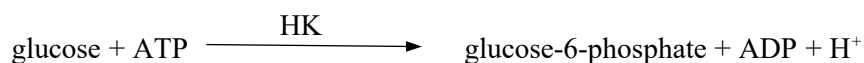

**COMPENDIUM OF INTERNATIONAL ANALYSIS OF METHODS -
OIV
Glucose, fructose and saccharose by differential pH-metry**

4. REAGENTS

- 4.1 Demineralised Water (18 M Ω) or bi-distilled**
- 4.2 2-Amino-2-(hydroxymethyl)propane-1,3-diol (TRIS) purity \geq 99%**
- 4.3 Disodic adenosine triphosphate (ATP, 2Na) purity \geq 99%**
- 4.4 Trisodium phosphate with twelve water molecules (Na₃PO₄.12H₂O) purity \geq 99%**
- 4.5 Sodium hydroxide (NaOH) purity \geq 98%**
- 4.6 Magnesium chloride with six water molecules (MgCl₂.6H₂O) purity \geq 99%**
- 4.7 Triton X 100**
- 4.8 Potassium chloride (KCl) purity \geq 99%**
- 4.9 2-Bromo-2-nitropropane-1,3-diol (Bronopol) (C₃H₆BrNO₄)**
- 4.10 Invertase (EC 3.2.1.26) 1 mg \cong 500 U (ex Sigma ref I-4504)**
- 4.11 Hexokinase (EC. 2.7.1.1) 1 mg \cong 145 U (e.g. Hofmann La Roche, Mannheim, Germany ref. Hexo-70-1351)**
- 4.12 Glycerol purity \geq 98%**
- 4.13 Saccharose purity \geq 99%**

4.14 Reagent buffer pH 8.0 commercial (ex. DIFFCHAMB GEN 644) or prepared according to the following method:

In a graduated 100-ml flask (5.2) pour roughly 70 ml (5.3) of water (4.1), and continuously stir (5.5). Add 0.242 g \pm 0.001 g (5.4) of TRIS (4.2), 0.787 g \pm 0.001 g (5.4) of ATP (4.3), 0.494 g \pm 0.001 g (5.4) of sodium phosphate (4.4), 0.009 mg \pm 0.001

g (5.4) of sodium hydroxide (4.5), 0.203 g \pm 0.001 g (5.4) of magnesium chloride (4.6), 2.000 \pm 0.001 g (5.4) of Triton X 100 (4.7), 0.820 g \pm 0.001 g (5.4) of potassium chloride (4.8) and 0.010 \pm 0.001 g (4.9) of bronopol. Adjust to volume with water (4.1). The final pH must be 8.0 \pm 0.1 (5.6), otherwise

**COMPENDIUM OF INTERNATIONAL ANALYSIS OF METHODS -
OIV
Glucose, fructose and saccharose by differential pH-metry**

adjust it with sodium hydroxide or hydrochloric acid. The buffer thus prepared is stable for two months at 4°C.

**COMPENDIUM OF INTERNATIONAL ANALYSIS OF METHODS -
OIV
Glucose, fructose and saccharose by differential pH-metry**

4.15 Enzyme solution commercial or prepared according to the following method:

Using a graduated pipette (5.7) place 5 ml of glycerol (4.11) into a graduated 10-ml flask, adjust to volume with water (4.1) and homogenize. Dissolve 300 mg \pm 1 mg (5.4) of invertase (4.10) 10 mg \pm 1 mg (5.4) of hexokinase (4.11) in 3 mL of glycerol solution. Enzyme solution activity must be 50 000 U \pm 100 U per ml for intervase and 480 U \pm 50 U for hexokinase. The enzyme solution is stable for 6 months at 4°C.

4.16 PREPARATION OF REFERENCE SOLUTION

Place 17,100 g \pm 0.01 g (5.4) of saccharose (4.13) (desiccated 12 hours beforehand at 40 °C until constant weight), 0.745 g \pm 0.001 g (5.4) of potassium chloride (4.8) and 0.010 g \pm 0.001 g (5.4) of bronopol in a graduated 100-ml flask (5.2). Add water (4.1). Fully homogenize (5.5). Adjust to volume with water (4.1) after removing the magnetic bar. The final concentration is 171 g/L of saccharose. The solution is stable for 6 months at 4°C.

5. APPARATUS

5.1 Differential pH-metry apparatus (EUROCHEM CL 10 plus, Microlab EFA or equivalent) see appendix A

5.2 Graduated 100-ml flask, class A

5.3 Graduated 100-ml test-tube with foot

5.4 Precision balance to weigh within 1 mg

5.5 Magnetic stirrer and magnetic Teflon bar

5.6 pH-meter

5.7 Graduated 3-mL, 5-mL pipette, class A

5.8 Graduated 10-ml flask, class A

5.9 Automatic syringe pipettes, 25 and 50 μ L

6. PREPARATION OF SAMPLES

Samples must not contain excessive suspended matter. If this occurs, the solution centrifuge and filter. Sparkling wines must be degassed

**COMPENDIUM OF INTERNATIONAL ANALYSIS OF METHODS -
OIV
Glucose, fructose and saccharose by differential pH-metry**

7. PROCEDURE

The operator must respect the instructions for use of the equipment (5.1). Before any use, the instrument must be stabilized in temperature. The circuits must be rinsed with the buffer solution (4.14) after cleaning, if required.

7.1 Determination of the blank (determination of the enzyme signal)

Fill the electrode compartments (EL₁ and EL₂) of the differential pH-meter (5.1) with the buffer solution (4.14); the potential difference between the two electrodes (D₁) must range between ± 150 mpH;

Add 32 μ L of enzyme solution (4.15) to the reaction vessel (using the micropipette 5.9 or the preparer) and fill electrode EL₂;

Measure the potential difference (D₂) between the two electrodes;

Calculate the difference in pH, Δ pH_o for the blank using the following formula:

$$\Delta\text{pH}_o = D_2 - D_1$$

where

Δ pH_o = the difference in pH between two measurements for the blank;

D₁ = the value of the difference in pH between the two electrodes filled with the buffer solution;

D₂ = the value of the difference in pH between the two electrodes, one of which is filled with the buffer solution and the other with the buffer solution and enzyme solution.

The value of Δ pH_o is used to check the state of the electrodes during titration as well as their possible drift over time; it must lie between -30 and 0 mpH and ≤ 1.5 mpH between two consecutive readings. If not, check the quality of the buffer pH and the cleanliness of the hydraulic system and electrodes, clean if necessary and then repeat the blank.

7.2 Calibration

Fill the electrode compartments (EL₁ and EL₂) with the buffer solution (4.14);

Add 10 μ L (with the micropipette 5.9 or the preparer) of the standard saccharose solution (5) to the reaction vessel;

Fill the electrodes EL₁ and EL₂ with the buffer + standard solution;

Measure the potential difference (D₃) between the two electrodes;

Add 32 μ L of enzyme solution (4.15) and fill electrode EL₂ with the buffer + standard solution + enzyme;

After the time necessary for the enzymatic reaction, measure the potential difference (D₄) between the two electrodes;

**COMPENDIUM OF INTERNATIONAL ANALYSIS OF METHODS -
OIV**

Glucose, fructose and saccharose by differential pH-metry

Calculate the difference in pH, ΔpH_c for the calibration sample using the following formula:

$$\Delta\text{pH}_c = (D_4 - D_3) - \Delta\text{pH}_o$$

where

ΔpH_c = the difference between two measurements D_3 and D_4 for the calibration sample minus the difference obtained for the blank;

D_3 = the value of the difference in pH between the two electrodes filled with the reference buffer/solution mixture;

D_4 = the value of the difference in pH between the two electrodes, one of which is filled with the reference buffer/solution and the other with the buffer/ enzyme / reference solution.

Calculate the slope of the calibration line:

$$s = C_u / \Delta\text{pH}_c$$

where

C_u is the concentration of saccharose in the standard solution expressed in g/L.

Check the validity of the calibration by analysing 10 μL of standard solution (ML) of saccharose (5) according to the procedure (8.3). The result must range between $\pm 2\%$ of the reference value. If not, repeat the calibration procedure.

7.3 Quantification

Fill the electrode compartments (EL_1 and EL_2) with the buffer solution (4.14)

Add 10 μL (with the micropipette 5.9 or the preparer) of the sample solution to the reaction vessel;

Fill electrodes EL_1 and EL_2 with the buffer + sample mixture;

Measure the potential difference (D_5) between the two electrodes;

Add 32 μL of the enzyme solution (4.15) and fill electrode EL_2 with the buffer mixture + sample + enzyme;

Measure the potential difference (D_6) between the two electrodes;

Calculate the quantity of aqueous solution in the sample using the following formula:

$$w = s \times [(D_6 - D_5) - \Delta\text{pH}_o]$$

where

**COMPENDIUM OF INTERNATIONAL ANALYSIS OF METHODS -
OIV
Glucose, fructose and saccharose by differential pH-metry**

w = the quantity of aqueous solution in the sample (in g/L);

S is the slope determined by the calibration line;

ΔpH_0 = the difference in pH between two measurements for the blank;

D_5 = the value of the difference in pH between the two electrodes filled with the sample/ reference solution;

D_6 = the value of the difference in pH between the two electrodes, one of which is filled with the buffer/sample and the other with the buffer/ sample /enzyme.

8 EXPRESSION OF RESULTS

The results are expressed in g/L of glucose with one significant figure after the decimal point.

9 CHARACTERISTICS OF THE ANALYSIS

Due to the hydrolysis of saccharose in wines and musts, it is not possible to organise an inter-laboratory analysis according to the OIV protocol.

Inter-laboratory studies of this method demonstrate that for saccharose, the linearity between 0 and 250 g/l, a detection limit of 0.2 g/l, a quantification limit of 0.6 g/l, repeatability of $0.0837x - 0.0249$ g/l and reproducibility of $0.0935x - 0.073$ g/l (saccharose content).

10 QUALITY CONTROL

Quality controls can be carried out with certified reference materials, wines whose characteristics have been determined by consensus, or loaded wines regularly used in analytical series, and by following the related control charts.

**COMPENDIUM OF INTERNATIONAL ANALYSIS OF METHODS -
OIV
Glucose, fructose and saccharose by differential pH-metry**

Appendix A

Diagram of the differential pH-metry apparatus

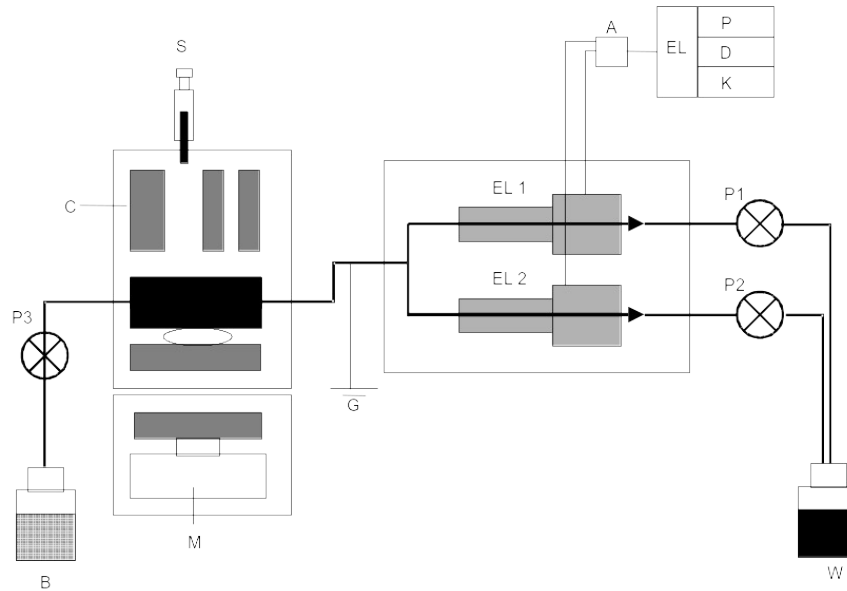

A: differential amplifier; B: buffer solution; C: mixing chamber; D: indicator; EL₁ and EL₂ capillary electrodes; EL: electronics; G: ground; K: keyboard; M: magnetic stirrer; P: printer; P₁ to P₃: peristaltic pumps; S: injection syringe for the sample and enzyme; W: waste.

Appendix B

BIBLIOGRAPHY

LUZZANA M., PERELLA M. et ROSSI-BERNARDI L (1971) : Electrometric method for measurement of small pH changes in biological systems. *Anal. Biochem*, 43, 556-563.

LUZZANA M., AGNELLINI D., CREMONESI P. et CARAMENTI G. (2001) : Enzymatic reactions for the determination of sugars in food samples using the differential pH technique. *Analyst*, 126, 2149 –2152.

LUZZANA M., LARCHER R., MARCHITTI C. V. et BERTOLDI D. (2003) : Quantificazione mediante pH-metria differenziale dell'urea negli spumanti metodo classico.in "Spumante tradizionale e classico nel terzo millennio" 27-28 giugno 2003, Istituti Agrario di San Mechele.

MOIO L., GAMBUTI A., Di MARZIO L. et PIOMBINO P. (2001) : Differential pHmeter determination of residual sugars in wine. *Am. J. Enol. Vitic*, 52(3), 271 – 274.

MOSCA A., DOSSI G., LUZZANA M., ROSSI-BERNARDI L., FRIAUF W. S., BERGER R.L., HOPKINS H. P. et CAREY V (1981) : Improved apparatus for the differential measurement of pH : application to the measurment of glucose. *Anal. Biochem.*, 112, 287 – 294.

TUSSEAU D., FENEUIL A., ROUCHAUSSE J.-M. et VAN LAER S. (2004) : Mesure de différents paramètres d'intérêt oenologique par pHmétrie différentielle. *F.V. O.I.V.* n° 1199, 5 pages.

COMPENDIUM OF INTERNATIONAL METHODS OF ANALYSIS-OIV
Determination of the $^{13}\text{C}/^{12}\text{C}$ isotope ratios of glucose,
fructose, glycerol, ethanol in production of vitivincultural origin
by high-performance liquid chromatography coupled to isotope
ratio mass spectrometry

Method OIV-MA-AS311-09

Type II and III method

Determination of the $^{13}\text{C}/^{12}\text{C}$ isotope ratios of glucose,
fructose, glycerol, ethanol in production of vitivincultural
origin by high-performance liquid chromatography coupled
to isotope ratio mass spectrometry
(Resolution OIV-OENO 479-2017)

1. Scope of application

This method applies to products of vitivincultural origin.

This method is:

- type II for glucose, fructose and glycerol,
- type III for ethanol.

2. Principle

The samples are injected into the HPLC instrument after any necessary dilution and filtration. After oxidation in a liquid interface, the $^{13}\text{C}/^{12}\text{C}$ isotope ratio of the compounds is determined using isotope ratio mass spectrometry. This liquid interface, symbolised by the acronym “*co*”, permits the chemical oxidation of the organic matter into CO_2 . HPLC-*co*-IRMS coupling can therefore be used to determine the isotope ratio of the following compounds simultaneously: glucose, fructose, glycerol and ethanol.

3. Reagents

- 3.1 Pure water - resistivity > 18 $\text{M}\Omega$ cm, HPLC quality
- 3.2 Ammonium persulfate – analytical purity – [CAS No.: 7727-54-0]
- 3.3 Orthophosphoric acid (concentration 85%) – analytical purity – [CAS No.: 7664-38-2]
- 3.4 Analytical-grade helium, used as a carrier gas [CAS No.: 07440-59-7]
- 3.5 Reference gas: analytical-grade CO_2 (carbon dioxide), used as a secondary reference gas [CAS No.: 00124-38-9]
- 3.6 International standards

4. Equipment

- 4.1 Everyday laboratory equipment
- 4.2 High-performance liquid chromatography instrument
- 4.3 Liquid interface for the oxidation of eluted compounds
- 4.4 Isotope ratio mass spectrometer

COMPENDIUM OF INTERNATIONAL METHODS OF ANALYSIS-OIV
Determination of the ¹³C/¹²C isotope ratios of glucose,
fructose, glycerol, ethanol in production of vitivinicultural origin
by high-performance liquid chromatography coupled to isotope
ratio mass spectrometry

5. Analysis of the samples

5.1 Preparation of the samples

Depending on the sugar, glycerol and ethanol contents, the samples should be diluted with the water (3.1) beforehand in order to obtain a concentration which is observable under the experimental conditions. Depending on the concentrations of the compounds, two measurements are needed with different dilutions.

5.2 Example of analytical conditions

Total analysis duration: 20 minutes

As an indication, the dilution of grape juices and wines is around 1:200, while that of concentrated musts is approximately 1:500.

HPLC:

Column: carbohydrate-type column (e.g. 700-CH Carbohydrate column, HyperRez XP Carbohydrate H⁺)

Injection volume: 25 µl

Mobile phase: water (3.1)

Flowrate: 0.4 mL/min

Column T°: 80 °C

Liquid Interface:

Solution of ammonium persulfate (3.2) (15% in mass) and orthophosphoric acid (2.5% in volume)

Peristaltic pump flow: 0.6 mL/min

Heater temperature: 93 °C

Flow of the helium carrier gas: 15 mL/min

Helium flow for drying: 50 mL/min

IRMS:

Trap current: 300 µA

COMPENDIUM OF INTERNATIONAL METHODS OF ANALYSIS-OIV
Determination of the ¹³C/¹²C isotope ratios of glucose,
fructose, glycerol, ethanol in production of vitivinicultural origin
by high-performance liquid chromatography coupled to isotope
ratio mass spectrometry

5.3 Example chromatogram

Chromatogram of a sweet wine analysed using HPLC-*co*-
IRMS

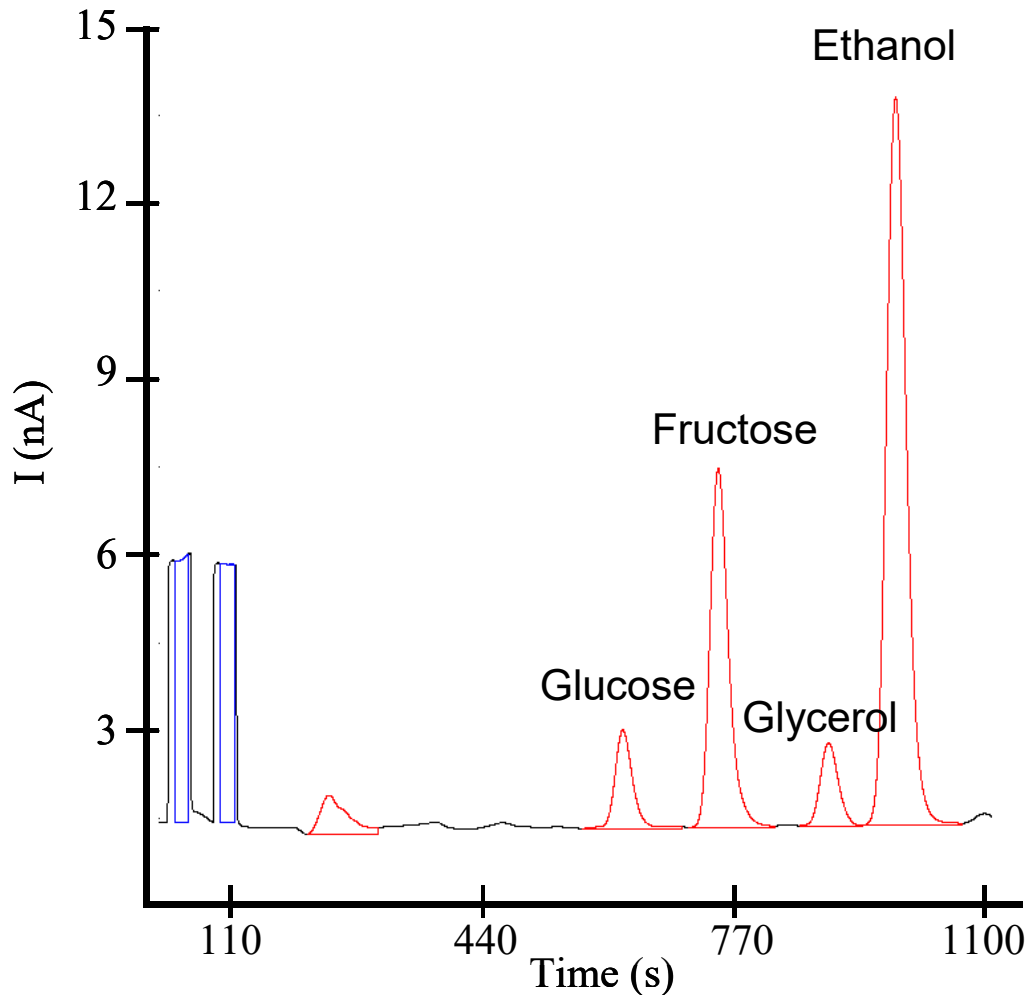

6. Determination of isotope ratios

The reference gas, CO₂, is calibrated from international commercial standards. The isotope ratios are expressed in δ ‰ in relation to the Pee Dee Belemnite (PDB) and are defined as:

$$\delta^{13}\text{C}_{\text{Sam}} (\text{‰}) = [(R_{\text{Sam}} / R_{\text{St}}) - 1] * 10^3$$

Where: Sam = sample; St = standard; R = ¹³C/¹²C isotope ratio

COMPENDIUM OF INTERNATIONAL METHODS OF ANALYSIS-OIV
Determination of the $^{13}\text{C}/^{12}\text{C}$ isotope ratios of glucose,
fructose, glycerol, ethanol in production of vitivinicultural origin
by high-performance liquid chromatography coupled to isotope
ratio mass spectrometry

7. Method characteristics

The characteristics of the method for the measurement of the $\delta^{13}\text{C}$ isotope ratios of glucose, fructose, glycerol and ethanol by HPLC-*co*-IRMS have been determined from the results obtained from an inter-laboratory analysis of four samples (dry wine, sweet wine, grape juice and rectified concentrated must). The results obtained for each compound analysed and each type of matrix are annexed.

8. Bibliography

1. Cabanero, AI.; Recio, JL.; Rupérez, M. (2008) Isotope ratio mass spectrometry coupled to liquid and gas chromatography for wine ethanol characterization. *Rapid Commun. Mass Spectrom.* 22: 3111-3118.
2. Cabanero, AI.; Recio, JL.; Rupérez, M. (2010) Simultaneous stable carbon isotopic analysis of wine glycerol and ethanol by liquid chromatography coupled to isotope ratio mass spectrometry. *J. Agric. Food Chem.* 58: 722-728.
3. Guyon, F.; Gaillard, L.; Salagoity, MH.; Médina, B. (2011) Intrinsic Ratios of Glucose, Fructose, Glycerol and Ethanol $^{13}\text{C}/^{12}\text{C}$ Isotopic Ratio Determined by HPLC-*co*-IRMS: Toward Determining Constants for Wine Authentication. *Anal. Bioanal. Chem.* 401:1551-1558

COMPENDIUM OF INTERNATIONAL METHODS OF ANALYSIS-OIV
Determination of the ¹³C/¹²C isotope ratios of glucose,
fructose, glycerol, ethanol in production of vitivinicultural origin
by high-performance liquid chromatography coupled to isotope
ratio mass spectrometry

Annex

Statistical treatment of the HPLC-*co*-IRMS inter-laboratory analysis
for the determination of the precision of the method (repeatability and
reproducibility)

List of laboratories in alphabetical order of country of origin.

<u>Country</u>	<u>Laboratory</u>
Belgium	IRMM
China	CNRIFFI
Czech Republic	SZPI
France	SCL-33
Germany	INTERTEK
Germany	UNI DUE
Germany	ELEMENTAR
Germany	QSI
Germany	LVI
Italy	FLORAMO
Japan	AKITA Univ.
Spain	MAGRAMA

Responses:

12 laboratories / 14 responses

Treatment of the results of inter-laboratory analyses according to ISO
5725-2

Samples:

- 1 dry wine (Wine A)
- 1 sweet wine (Wine B)
- 1 rectified concentrated must (RCM)
- 1 grape juice

Analytical conditions:

COMPENDIUM OF INTERNATIONAL METHODS OF ANALYSIS-OIV
Determination of the ¹³C/¹²C isotope ratios of glucose,
fructose, glycerol, ethanol in production of vitivinicultural origin
by high-performance liquid chromatography coupled to isotope
ratio mass spectrometry

Each sample was analysed in duplicate (repeatability) and double blind (reproducibility)

Expression of results in ‰ vs. PDB

Precision of the glucose measurement
Repeatability and reproducibility

	Wine B	RCM	Grape juice
Number of laboratories	12	12	12
Number of responses	14	13	14
Number of responses retained (elimination of outliers)	13	13	12
Minimum value	-26.33	-25.04	-25.78
Maximum value	-23.72	-23.74	-24.62
Mean value	-25.10	-24.24	-25.19
Repeatability variance	0.02	0.01	0.01
Repeatability standard deviation (S _r)	0.14	0.10	0.09
Repeatability limit (r ‰)	0.40	0.29	0.24
Reproducibility variance	0.39	0.14	0.11
Reproducibility standard deviation (S _R)	0.62	0.38	0.33
Reproducibility limit (R ‰)	1.77	1.06	0.94

COMPENDIUM OF INTERNATIONAL METHODS OF ANALYSIS-OIV
Determination of the ¹³C/¹²C isotope ratios of glucose,
fructose, glycerol, ethanol in production of vitivinicultural origin
by high-performance liquid chromatography coupled to isotope
ratio mass spectrometry

Precision of the fructose measurement
Repeatability and reproducibility

	Wine B	RCM	Grape juice
Number of laboratories	12	11	12
Number of responses	14	13	14
Number of responses retained (elimination of outliers)	13	13	13
Minimum value	-25.56	-24.19	-25.33
Maximum value	-24.12	-23.19	-23.98
Mean value	-24.87	-23.65	-24.56
Repeatability variance	0.02	0.03	0.02
Repeatability standard deviation (S _r)	0.14	0.16	0.14
Repeatability limit (r ‰)	0.40	0.46	0.39
Reproducibility variance	0.15	0.10	0.18
Reproducibility standard deviation (S _R)	0.39	0.32	0.42
Reproducibility limit (R ‰)	1.10	0.90	1.19

COMPENDIUM OF INTERNATIONAL METHODS OF ANALYSIS-OIV
Determination of the $^{13}\text{C}/^{12}\text{C}$ isotope ratios of glucose,
fructose, glycerol, ethanol in production of vitivinicultural origin
by high-performance liquid chromatography coupled to isotope
ratio mass spectrometry

Precision of the glycerol measurement
Repeatability and reproducibility

	Wine A	Wine B
Number of laboratories	12	12
Number of responses	12	12
Number of responses retained (elimination of outliers)	11	11
Minimum value	-32.91	-30.74
Maximum value	-30.17	-28.27
Mean value	-31.75	-29.54
Repeatability variance	0.13	0.04
Repeatability standard deviation (S_r)	0.36	0.19
Repeatability limit (r ‰)	1.03	0.55
Reproducibility variance	0.57	0.37
Reproducibility standard deviation (S_R)	0.76	0.61
Reproducibility limit (R ‰)	2.14	1.72

COMPENDIUM OF INTERNATIONAL METHODS OF ANALYSIS-OIV
Determination of the $^{13}\text{C}/^{12}\text{C}$ isotope ratios of glucose, fructose, glycerol, ethanol in production of vitivinicultural origin by high-performance liquid chromatography coupled to isotope ratio mass spectrometry

Precision of the ethanol measurement
Repeatability and reproducibility

	Wine A	Wine B
Number of laboratories	12	12
Number of responses	11	12
Number of responses retained (elimination of outliers)	10	12
Minimum value	-27.85	-27.60
Maximum value	-26.50	-26.06
Mean value	-27.21	-26.82
Repeatability variance	0.03	0.03
Repeatability standard deviation (S_r)	0.16	0.17
Repeatability limit (r ‰)	0.47	0.47
Reproducibility variance	0.16	0.23
Reproducibility standard deviation (S_R)	0.40	0.47
Reproducibility limit (R ‰)	1.14	1.34

**Determination of D-glucose and D-fructose in wines by
automated enzymatic method**
(Résolution OIV-OENO 600-2018)

1. Scope of application

This method makes it possible to determine the sum of D-glucose and D-fructose in wine by specific enzyme analysis using an automatic sequential analyser. In this document a collaborative study is reported which demonstrates application of the method for measurement of D-glucose and D-fructose from 0.1 to 96.31 g/L, taking into account the introduction of a dilution of the sample above 5 g/L.

Note: Where necessary, each laboratory using this method may refine, and potentially widen, this range through a validation study.

2. Standard references

- OIV *Compendium of International Methods of Analysis: Glucose and fructose – enzymatic method*, OIV-MA-AS311-02,
- ISO 78-2: Chemistry – Layouts for standards.

3. Reaction principles

D-glucose and D-fructose are phosphorylated by adenosine triphosphate (ATP) during an enzymatic reaction catalysed by hexokinase (HK) to produce glucose-6-phosphate (G6P) and fructose-6-phosphate (F6P).

COMPENDIUM OF INTERNATIONAL METHODS OF ANALYSIS-OIV
Determination of D-glucose and D-fructose in wine
by automated enzymatic method



Glucose-6-phosphate is first oxidised to gluconate-6-phosphate by nicotinamide adenine dinucleotide phosphate (NADP) in the presence of the enzyme glucose-6-phosphate dehydrogenase (G6PDH). The quantity of reduced nicotinamide adenine dinucleotide phosphate (NADPH) is directly correlated with that of glucose-6-phosphate and thus with that of D-glucose.

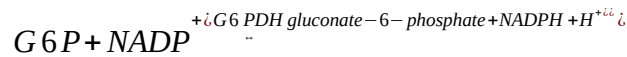

Fructose-6-phosphate (F6P) is converted into glucose-6-phosphate (G6P) in the presence of phosphoglucose isomerase (PGI):



The glucose-6-phosphate thus formed reacts as shown in the above formula. The reduced nicotinamide adenine dinucleotide phosphate (NADPH) produced is measured based on its absorption at 340 nm.

4. Reagents and working solutions

During the analysis – unless stated otherwise – only use reagents of recognised analytical grade and water that is distilled, demineralised or of equivalent purity.

4.1. Reagents

- 4.1.1. Quality I or II water for analytical usage (ISO 3696 standard)
- 4.1.2. Triethanolamine hydrochloride (CAS no. 637-39-8)
- 4.1.3. NADP (nicotinamide adenine dinucleotide phosphate) (CAS no. 24292-60-2)
- 4.1.4. ATP (adenosine-5'-triphosphate) (CAS no. 34369-07-8)
- 4.1.5. MgSO₄ (anhydrous magnesium sulphate) (CAS no. 7487-88-9)
- 4.1.6. Sodium hydroxide (CAS no. 1310-73-2)
- 4.1.7. Hexokinase (HK) (CAS no. 9001-51-8)
- 4.1.8. Glucose-6-phosphate dehydrogenase (G6PDH) (CAS no. 9001-40-5)
- 4.1.9. Phosphoglucose isomerase (PGI): lyophilised powder, 400-600 units/mg protein (CAS no. 9001-41-6)
Note: One unit ensures the conversion of 1.0 μ mole of D-fructose-6-phosphate into D-glucose-6-phosphate per minute at pH 7.4 and 25 °C
- 4.1.10. Polyvinylpyrrolidone (PVP) (CAS no. 9003-39-8)
- 4.1.11. D-glucose: purity \geq 99.5% (CAS no. 50-99-7)
- 4.1.12. D-fructose: purity \geq 99% (CAS no. 57-48-7)

Note 1: There are commercial kits for the determination of D-glucose and D-fructose. The user needs to check the composition to ensure it contains the above-indicated reagents.

Note 2: The use of PVP is recommended to eliminate any possible negative effect of tannins in wine on the enzyme protein molecules. This is the case particularly in red wines. Should the use of PVP not prove effective, the laboratory should ensure that the wine tannins do not interfere with the enzymes.

4.2. Working solutions

- 4.2.1. Triethanolamine hydrochloride buffer and magnesium sulphate adjusted to pH 7.6. The preparation may be as follows:
 - triethanolamine hydrochloride (4.1.2): 11.2 g,
 - magnesium sulphate (4.1.5): 0.2 g,
 - PVP (4.1.10): 2 g,
 - water for analytical usage (4.1.1): 150 mL.

COMPENDIUM OF INTERNATIONAL METHODS OF ANALYSIS-OIV
Determination of D-glucose and D-fructose in wine
by automated enzymatic method

The mixture is adjusted to pH 7.6 using a 5 M sodium hydroxide solution, then made up to 200 mL with water for analytical usage. The solution is stable for at least 4 weeks at 2-8 °C.

- 4.2.2. R1 working solution (example):
- triethanolamine buffer (4.2.1): 50 mL,
 - NADP (4.1.3): 117 mg,
 - ATP (4.1.4): 150 mg.

- 4.2.3. R2 working solution (example):
- triethanolamine buffer (4.2.1): 2 mL,
 - HK (4.1.7): 270 U,
 - G6PDH (4.1.8): 340 U,
 - PGI (4.1.9): 640 U.

Note: Commercial preparations of a HK/6GPDH mixture may be used.

Note: When preparing these solutions, they should be mixed gently to prevent foam from forming. The life cycle of the working solutions is limited and should be evaluated and respected by the laboratory.

4.3. Calibration solutions

To ensure the closest possible connection to the International System of Units (SI), the calibration range should be created using pure solutions of D-glucose and D-fructose prepared by weighing and covering the measurement range.

5. Apparatus

5.1. Analyser

5.1.1. Equipment type

Automatic sequential analyser equipped with a spectrophotometer with UV detector. The reaction temperature should be stable (around 37 °C). The reaction cuvettes are glass, methacrylate or quartz. The equipment is controlled by software ensuring its operation, data acquisition and useful calculations.

5.1.2. Absorbance reading

The concentration of the analytes directly relates to the absorbance difference read by the spectrophotometer. The precision of the absorbance reading should be a

minimum of 0.1 absorbance unit (AU). It is preferable not to use absorbance values higher than 2.0.

5.1.3. Precision of volumes collected

The precision of the volumes of reagents and samples collected by the pipettes of the analyser influences the measurement result. Quality control of the results using appropriate strategies (e.g. according to the guides published by the OIV) is recommended.

5.1.4. Reaction duration and temperature

In general, the reaction time is 10 minutes and the temperature is 37 °C. Certain pieces of apparatus may use slightly different values.

5.1.5. Wavelength

The wavelength of maximum absorption of the NADPH formed by the reaction is 340 nm. This wavelength will be selected for the spectrophotometers commonly used. Some analysers are equipped with photometers that use a mercury-vapor lamp. In this case, a wavelength with a reading of 365 or 334 nm is to be selected.

5.2. Balance

This should be calibrated to the International System of Units and have 1 mg precision.

5.3. pH meter

5.4. Measuring glassware

The measuring glassware for the preparation of reagents and calibration solutions is class A.

6. Sampling

6.1 Preparation of samples of musts and wines

The majority of wine and must samples may be analysed without preparation. In some cases, a preparation may be introduced:

filtration should be used for highly turbid samples,
sample dilution (manual or automatic) with water for analytical usage (4.1.1) should be used for values exceeding the measurement range. By way of example, factors of 10x, 20x or 40x are used for musts. Given their impact on the uncertainty budget, these dilutions should be conducted with the utmost care.

COMPENDIUM OF INTERNATIONAL METHODS OF ANALYSIS-OIV
Determination of D-glucose and D-fructose in wine
by automated enzymatic method

6.2 Preparation of samples of wines containing CO₂

Wine samples containing CO₂ may produce bubbling effects. They must be degassed beforehand by stirring under vacuum, ultrasonic processing or any method enabling the required degassing.

7. Procedure

Given that different analysers may be used, it is recommended that the conditions of use provided by the manufacturer are strictly observed. This also applies to the different enzymatic kits available on the market.

The procedure takes place as follows:

1. The sample (S) is placed in a reaction cuvette.
2. Working solution R1 (4.2.2) is then added to the cuvette.
3. The two are mixed together. Time is then allowed for a lag period, in order to guarantee absorbance stability. This lag period may last from 1-5 min, and is defined by the laboratory, according to the characteristics of the equipment used.
4. Working solution R2 (4.2.3) is added and the reaction takes place.

By way of example, the quantities of different elements may be as follows:

- sample: 2.0 µL,
- R1: 40 µL,
- R2: 40 µL.

The equipment takes regular measurements (every 12 seconds, for example) that make it possible to obtain a reaction curve, an example of which is given in Figure 1.

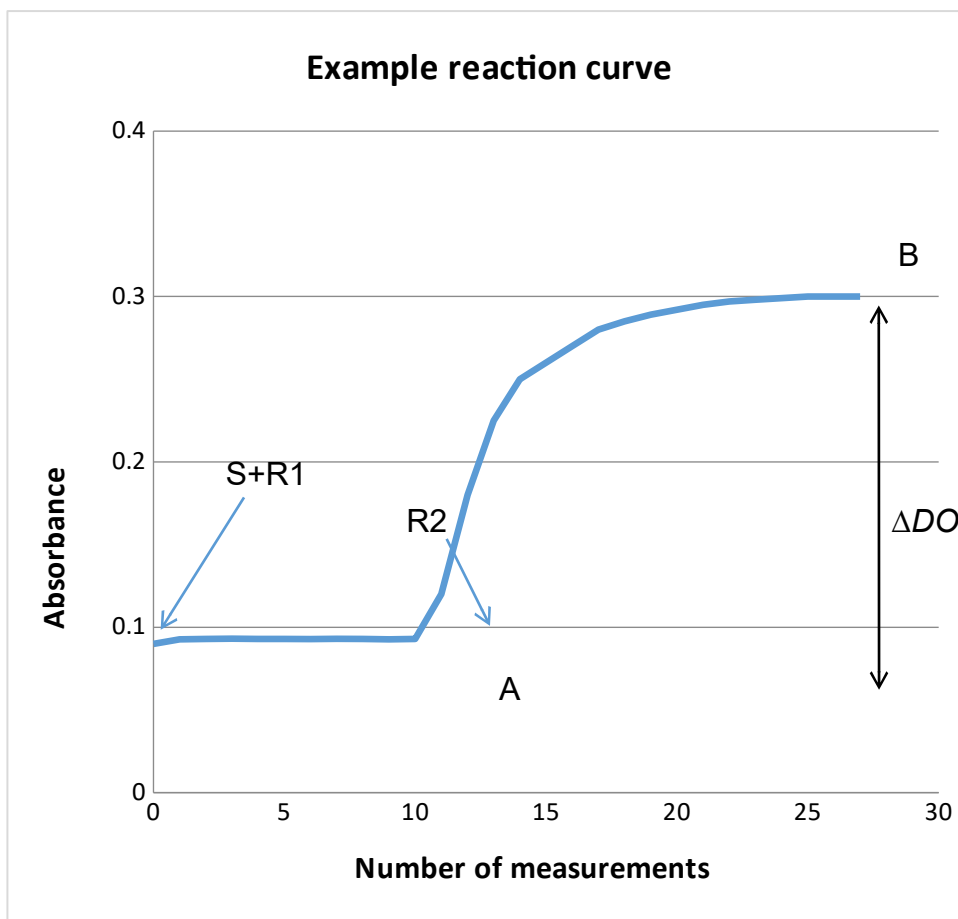

Figure 1: Reaction curve

The equipment makes it possible to choose the reading points for the difference in absorbance sought, for example A and B in Figure 1.

8. Calculation of results

The measurement used for the determination of the result is as follows:

$$\Delta DO = \lambda (\text{Absorbance } B - \text{Absorbance } A)$$

In order to correlate this ΔDO value with the desired concentration of D-glucose and D-fructose, calibration of the equipment is carried out using the calibration

COMPENDIUM OF INTERNATIONAL METHODS OF ANALYSIS-OIV
Determination of D-glucose and D-fructose in wine
by automated enzymatic method

solutions at a minimum of 3 points (§4.3) covering the measurement range. In addition, a reagent blank is used comprising all of the reagents but no sample (point 0 of the calibration).

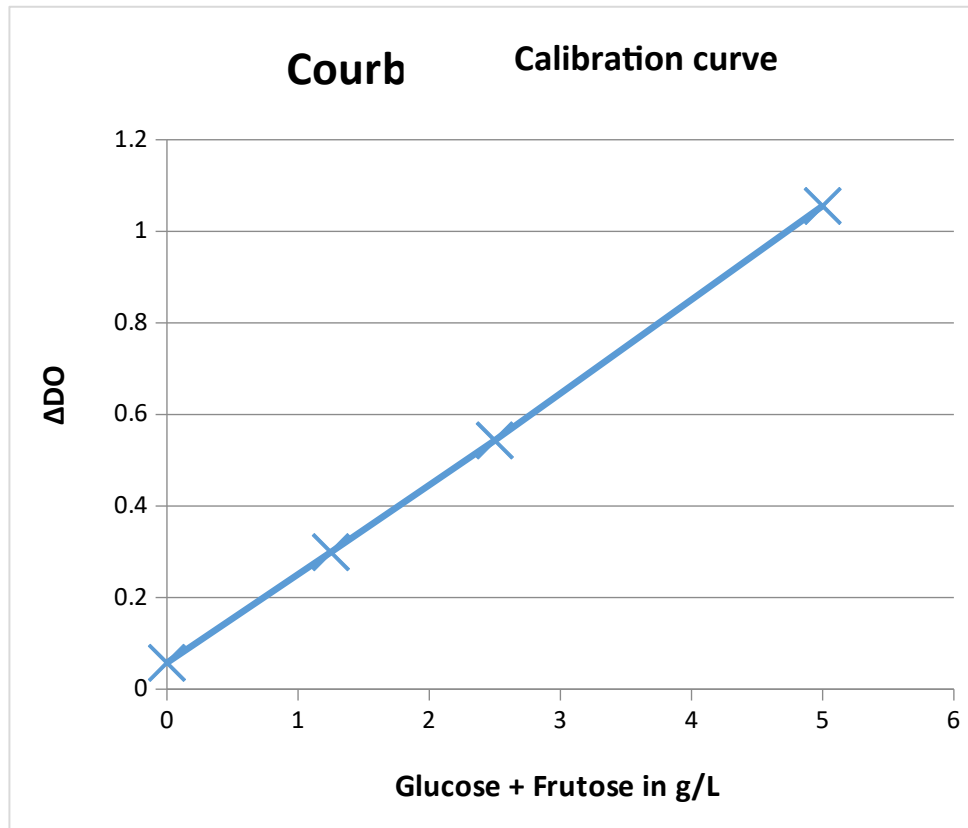

Figure 2: Calibration curve

The calibration curve can be order 1 ($Concentration = a.\Delta DO + b$) or even order 2 ($Concentration = a.\Delta DO^2 + b.\Delta DO + c$). If using a calibration curve of order 2, the laboratory should take care to limit the calibration domain in order to maintain sufficient sensitivity of the method (risk of crushing the curve).

The final value obtained should be multiplied by any coefficient of dilution used.

9. Expression of results

The D-glucose + D-fructose results are expressed in g/L to 2 d.p.

10. Precision

Interlaboratory reproducibility

$RSD_R = 5\%$ (from 1 g/L)

$CV_R\% (k=2) = 2 \cdot RSD_R = 10\%$, (from 1 g/L)

Repeatability

$RSD_r = 1.5\%$ (from 1 g/L)

$CV_r\% (k=2) = 2 \cdot RSD_r = 3\%$ (from 1 g/L)

Limit of quantification

Validated LOQ = 0, 10 g/L

(Concentration where $CV_R\% (k=2) = 60\%$)

ANNEX Results of the interlaboratory tests

Collaborative study

A total of 17 laboratories from different countries participated in the collaborative study, organised in 2016.

Labo	Country
Miguel Torres S.A.- Finca Mas La Plana	SPAIN
Estación Enológica de Castilla y León	SPAIN
INGACAL -Consellería do Medio Rural Estación de Viticultura e Enoloxía de Galicia	SPAIN
Estación Enológica de Haro	SPAIN
Instituto dos Vinhos do Douro e do Porto, IP	PORTUGAL
Comissão de Viticultura da Região dos Vinhos Verdes	PORTUGAL
Laboratoires Dubernet	FRANCE

OIV-MA-AS311-10 : R2018

COMPENDIUM OF INTERNATIONAL METHODS OF ANALYSIS-OIV
Determination of D-glucose and D-fructose in wine
by automated enzymatic method

Laboratoire Dicenos Rhône	FRANCE
Laboratoire Natoli	FRANCE
SCL Montpellier	FRANCE
Agricultural institute of Slovenia	SLOVENIA
Fachbereich: Wein, Weinüberwachung - Chemisches und Veterinäruntersuchungsamt Karlsruhe	GERMANY
HBLAuBA Wein - und Obstbau	AUSTRIA
Landesuntersuchungsamt Mainz	GERMANY
Hochschule GEISENHEIM University Institut Weinanalytik und Getränkeforschung	GERMANY
Unità Chimica Vitienologica e Agroalimentare - Centro Trasferimento Tecnologico - Fondazione Edmund Mach	ITALY
Unione Italiana Vini soc. Coop.	ITALY

For analysis, 2 x 10 blind duplicate samples were used, with 1 repetition. The wines analysed are wines originating from France and Portugal, dry wines and liqueur wines.

COMPENDIUM OF INTERNATIONAL METHODS OF ANALYSIS-OIV
Determination of D-glucose and D-fructose in wine
by automated enzymatic method

Sample		A		B		C		D		E		F		G		H		I		J	
Position		1	9	2	13	3	4	5	15	6	10	16	20	7	11	12	17	8	19	14	18
Labo3	rep#1	94.00	96.00	3.40	3.50	0.40	0.40	0.90	1.10	2.10	2.50	0.10	0.10	1.40	1.40	5.60	5.90	4.70	4.20	17.50	17.00
	rep#2	96.00	98.00	3.50	3.60	0.40	0.30	1.00	1.10	2.20	2.40	0.10	0.10	1.40	1.40	5.70	6.00	4.30	4.50	17.50	17.00
Labo6	rep#1	97.50	95.00	3.42	3.25	0.35	0.48	1.05	0.98	3.24	2.65	0.08	0.05	1.42	1.40	5.49	5.57	4.04	4.11	13.63	19.00
	rep#2	97.00	94.50	3.39	3.29	0.37	0.57	1.08	1.01	3.34	2.66	0.08	0.08	1.52	1.45	5.42	5.52	3.95	4.13	13.70	20.50
Labo7	rep#1	99.22	99.53	3.46	3.56	0.31	0.34	1.00	0.98	2.50	2.58	0.04	0.04	1.49	1.39	5.77	5.75	4.26	4.35	17.66	17.35
	rep#2	100.30	98.90	3.53	3.53	0.31	0.32	1.02	1.02	2.48	2.50	0.04	0.02	1.48	1.34	5.89	5.79	4.23	4.40	17.21	17.94
Labo9	rep#1	92.00	94.20	3.05	3.03	0.29	0.30	0.93	0.97	2.30	2.16	0.04	0.04	1.25	1.25	5.02	5.01	3.98	3.76	15.60	15.76
	rep#2	95.00	97.25	3.03	3.23	0.32	0.31	0.94	0.90	2.20	2.29	0.03	0.04	1.27	1.25	5.14	5.39	3.80	4.06	16.64	16.40
Labo10	rep#1	90.79	92.31	3.27	3.36	0.34	0.34	0.97	1.01	2.28	2.30	0.09	0.07	1.28	1.26	5.46	5.42	3.27	3.36	17.92	17.99
	rep#2	92.13	91.65	3.34	3.24	0.32	0.35	0.97	1.04	2.28	2.33	0.08	0.08	1.32	1.28	5.18	5.37	3.34	3.24	17.58	17.68
Labo11	rep#1	91.40	91.28	3.06	3.12	0.57	0.30	0.95	0.93	2.15	2.18	0.07	0.05	1.16	1.22	5.19	5.34	3.70	3.86	16.22	16.47
	rep#2	90.13	89.94	3.10	3.14	0.56	0.30	0.93	0.93	2.14	2.18	0.07	0.06	1.16	1.20	5.28	5.18	3.76	3.86	16.13	16.33
Labo12	rep#1	100.00	100.00	3.25	3.27	0.34	0.33	1.03	1.10	2.35	2.75	0.08	0.10	1.30	1.39	5.66	5.64	4.07	4.13	17.30	17.44
	rep#2	101.00	97.00	3.22	3.25	0.34	0.33	1.03	1.11	2.36	2.75	0.08	0.10	1.30	1.39	5.62	5.68	4.07	4.15	17.50	17.80

COMPENDIUM OF INTERNATIONAL METHODS OF ANALYSIS-OIV
Determination of D-glucose and D-fructose in wine
by automated enzymatic method

Labo13	rep#1	96.60	96.00	3.04	3.07	0.34	0.31	0.97	0.94	2.26	2.50	0.05	0.04	1.25	1.25	5.21	5.29	3.84	3.99	16.08	16.03
	rep#2	96.00	95.10	3.07	3.12	0.32	0.32	0.97	1.04	2.25	2.25	0.04	0.04	1.25	1.28	5.24	5.31	3.90	3.97	15.95	16.18
Labo14	rep#1	104.00	98.00	3.19	3.16	0.33	0.33	0.97	0.96	2.47	2.44	0.05	0.05	1.34	1.32	5.77	5.81	4.20	4.21	17.76	17.04
	rep#2	103.00	96.00	3.18	3.17	0.33	0.33	0.97	0.97	2.48	2.44	0.05	0.05	1.34	1.32	5.77	5.78	4.20	4.14	17.44	17.24
Labo15	rep#1	110.03	99.25	3.63	3.60	0.20	0.19	0.94	0.97	2.54	2.36			1.30	1.20	5.65	6.14	4.56	4.43	17.16	19.33
	rep#2	104.39	99.34	3.59	3.72	0.20	0.20	0.94	0.95	2.52	2.32			1.32	1.20	5.62	6.19	4.39	4.54	17.41	19.29
Labo16	rep#1	95.20	94.08	3.20	3.22	0.32	0.32	0.96	0.96	2.24	2.26	0.06	0.06	1.23	1.23	5.19	5.19	3.89	3.84	17.82	17.38
	rep#2	96.00	94.41	3.17	3.18	0.31	0.33	0.95	0.94	2.25	2.22	0.06	0.06	1.24	1.22	5.13	5.15	3.85	3.86	17.84	17.24
Labo17	rep#1	96.68	97.10	3.28	3.38	0.47	0.43	1.03	1.03	2.41	2.46	0.10	0.20	1.36	1.36	5.52	5.53	4.09	4.00	16.42	17.30
	rep#2	97.08	99.40	3.24	3.33	0.39	0.38	0.95	0.96	2.30	2.36	0.20	0.15	1.32	1.24	5.38	5.40	3.95	4.10	16.50	16.60
Labo18	rep#1	90.23	91.39	3.14	3.26	0.46	0.47	1.12	1.10	2.30	2.44	0.23	0.24	1.38	1.30	5.19	5.49	3.91	4.10	14.83	14.89
	rep#2	90.02	91.74	3.18	3.31	0.47	0.47	1.07	1.07	2.31	2.40	0.23	0.24	1.38	1.32	5.23	5.45	3.94	4.04	14.82	14.85
Labo19	rep#1	99.63	103.55	3.34	3.41	0.32	0.32	0.98	0.97	2.38	2.41	0.04	0.05	1.29	1.30	5.68	5.56	4.10	4.11	17.61	17.49
	rep#2	100.57	103.28	3.36	3.42	0.32	0.32	0.98	0.97	2.36	2.42	0.05	0.05	1.29	1.31	5.61	5.59	4.10	4.11	17.53	17.51
Labo20	rep#1	96.41	96.18	3.20	3.23	0.32	0.32	0.96	0.95	2.26	2.32	0.07	0.08	1.24	1.24	5.35	5.40	3.92	4.03	16.36	16.51
	rep#2	96.32	95.89	3.18	3.23	0.32	0.32	0.96	0.95	2.26	2.32	0.07	0.08	1.24	1.24	5.35	5.38	3.92	4.03	16.38	16.49
Labo21	rep#1	103.60	102.02	3.37	3.60	0.23	0.25	0.95	0.98	2.41	2.49	0.05	0.05	1.27	1.33	5.95	6.12	4.02	4.53	18.41	19.70

	rep#2	102.50	103.02	3.34	3.51	0.23	0.26	0.92	0.98	2.45	2.45	0.03	0.05	1.26	1.27	6.02	5.99	4.09	4.42	18.96	19.90
Labo22	rep#1	96.73	96.59	3.25	3.28	0.28	0.28	0.92	0.93	2.25	2.31	0.06	0.05	1.23	1.28	5.51	5.47	4.02	3.98	17.09	17.10
	rep#2	97.06	96.34	3.24	3.21	0.30	0.30	0.93	0.93	2.26	2.30	0.04	0.05	1.21	1.24	5.40	5.39	4.03	4.04	17.05	17.01

Table of the data obtained. The values in bold correspond with the values rejected in accordance with the Cochran (variance outliers) test with a 2.5% significance level (one-tailed test), and the Grubbs (outliers from the mean) test with significance levels of 2.5% (two-tailed test).

Note: The absent values have not been provided by the laboratory in question.

COMPENDIUM OF INTERNATIONAL METHODS OF ANALYSIS-OIV
Determination of D-glucose and D-fructose in wine
by automated enzymatic method

Sample	A	B	C	D	E	F	G	H	I	J
No. of laboratories selected	15	17	14	17	14	14	17	16	15	14
No. of repetitions	4	4	4	4	4	4	4	4	4	4
Min.	90.69	3.08	0.20	0.93	2.16	0.04	1.19	5.14	3.80	14.85
Max.	102.79	3.64	0.47	1.09	2.52	0.10	1.45	6.02	4.48	17.79
Overall average	96.31	3.29	0.32	0.98	2.34	0.06	1.30	5.50	4.05	16.86
Repeatability variance	1.449	0.004	0.000	0.001	0.004	0.000	0.001	0.009	0.005	0.065
Inter-laboratory stand. dev.	3.60	0.16	0.06	0.05	0.10	0.02	0.07	0.26	0.17	0.83
Reproducibility variance	14.037	0.029	0.004	0.003	0.013	0.000	0.006	0.073	0.034	0.739
Repeatability variance	1.20	0.06	0.01	0.04	0.06	0.01	0.04	0.09	0.07	0.26
r limit	3.40	0.17	0.04	0.10	0.17	0.02	0.11	0.26	0.21	0.72
Repeatability RSD _r	1.2%	1.8%	4.4%	3.6%	2.5%	13.2%	2.9%	1.7%	1.8%	1.5%
Reproducibility stand. dev.	3.75	0.17	0.07	0.06	0.11	0.02	0.08	0.27	0.19	0.86
R limit	10.60	0.48	0.19	0.16	0.32	0.06	0.22	0.76	0.52	2.43
Reproducibility RSD _R	3.9%	5.1%	20.4%	5.7%	4.8%	35.3%	6.1%	4.9%	4.6%	5.1%
Horwitz RSD _r	1.877	3.120	4.425	3.742	3.284	5.694	3.588	2.889	3.025	2.440
Horrat _r	0.666	0.587	1.001	0.952	0.773	2.315	0.804	0.585	0.593	0.621

Horwitz RSD _R	2.84	4.73	6.70	5.67	4.98	8.63	5.44	4.38	4.58	3.70
Horrat _R	1.368	1.086	3.036	0.997	0.965	4.087	1.123	1.122	1.000	1.378

Table of the results obtained

Note: The results from sample F should be taken with caution due to the very low concentration levels, which are below to the laboratories' limit of quantification.

COMPENDIUM OF INTERNATIONAL METHODS OF ANALYSIS-OIV
Determination of D-glucose and D-fructose in wine
by automated enzymatic method

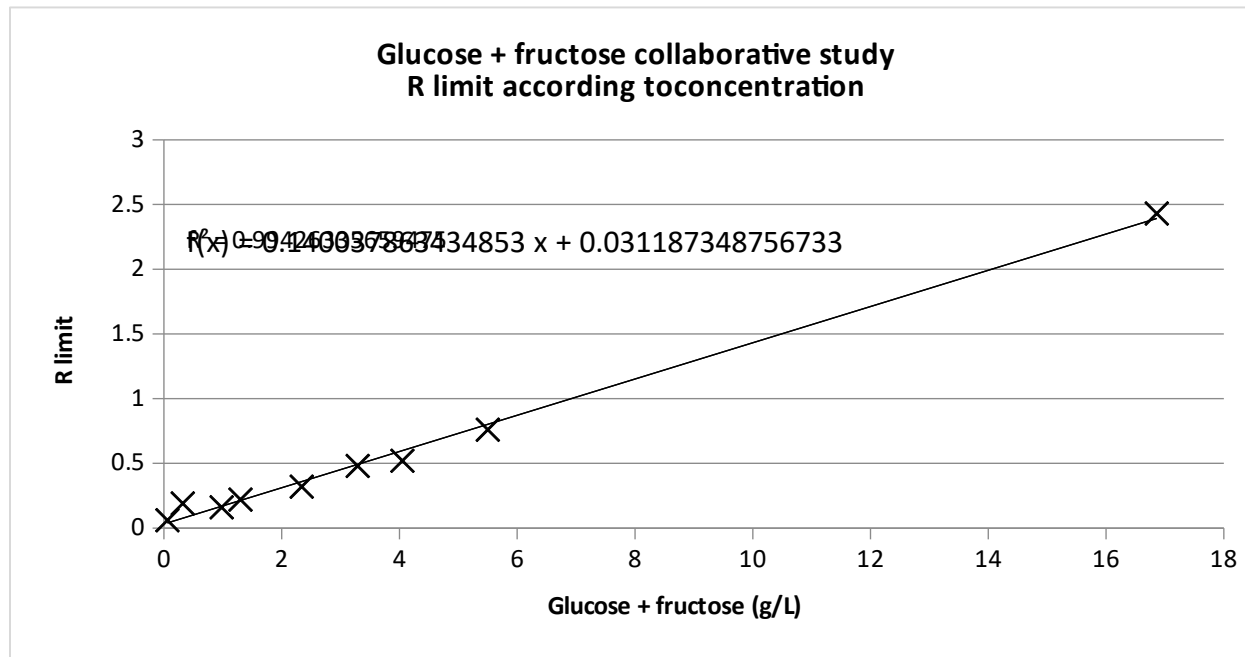

OIV-MA-AS311-10 : R2018

16

Figure 3: R limit according to concentration

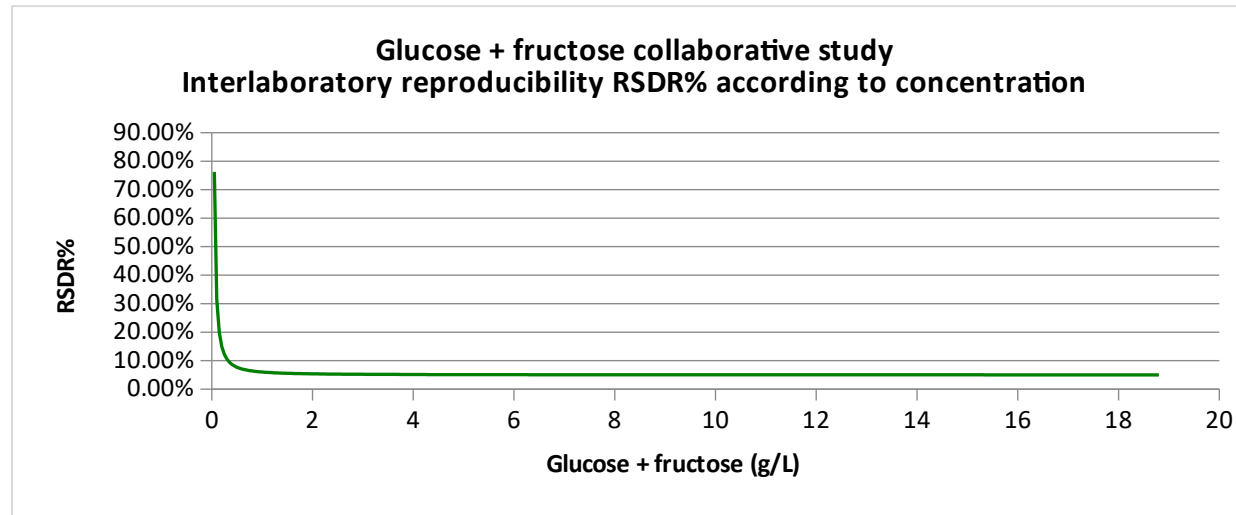

Figure 4: Interlaboratory RSD_R % according to concentration.

Modelling: $RSD_R\% = 1 \cdot C^{(-1.424)} + 5$

COMPENDIUM OF INTERNATIONAL METHODS OF ANALYSIS-OIV
Determination of D-glucose and D-fructose in wine
by automated enzymatic method

Method OIV-MA-AS312-01

Type I and Type IV Methods

Alcoholic strength by volume

(A2; OENO 8/2000

OENO 24/2003

OIV/OENO 377/2009

OIV-OENO 601B - 2021

1 Introduction

This resolution is made up of one part on distillate preparation, followed by 4 methods (A, B, C and D) to determine the alcoholic strength by volume of this distillate.

2 Scope of application

This resolution is applicable for determining the alcoholic strength by volume at 20 °C of vitivinicultural beverages, using any of the following:

- Method A: Pycnometry Type I Method,
- Method B: Electronic densimetry Type I Method,
using a frequency oscillator
- Method C: Hydrostatic balance Type I Method,
- Method D: Hydrometry and Common Type IV Method.
refractometry

3 Definition

The alcoholic strength by volume (ABV) of a beverage is the number of litres of ethanol contained in 100 litres of hydroalcoholic solution with the same density as the beverage distillate; both volumes being determined at a temperature of 20 °C. It is expressed by the symbol '% vol.'.

4 Principle and methods

4.1 Principle

The principle of the method consists firstly of distilling the beverage by volume to volume after alkalisation by a suspension of calcium hydroxide, which prevents the entrainment of volatile acids. This distillation enables the elimination of non-volatile substances. The homologues of ethanol, in addition to ethanol and its homologues in esters are included in the ABV since they are present in the distillate.

Secondly, the density of the distillate is measured. The density of a liquid at a given temperature is equal to the quotient of its mass over its volume:

$\rho = m / V$, and for a vitivincultural beverage, it is expressed as g/cm^3 .

For hydro-alcoholic solutions such as distillates, when the temperature is known, the tables can be used to match the density up to the ABV (OIV, MA-AS312-02: R2009 Table 1). This ABV corresponds to that of the beverage (distillation by volume to volume).

4.2 Methods of determination of ABV

The principle and procedure for each method are detailed in the following parts:

- Part A: Determination of the alcoholic strength by volume of a beverage by measuring of the density of the distillate using a pycnometer;
- Part B: Determination of the alcoholic strength by volume of a beverage by measuring the density of the distillate by electronic densimetry using a frequency oscillator;
- Part C: Determination of the alcoholic strength by volume of a beverage by measuring the density of the distillate by densimetry using a hydrostatic balance;
- Part D: Determination of the alcoholic strength by volume of a beverage by measuring the density of the distillate by hydrometry or by refractometry.

The test temperature is set at 20 °C.

4.3 Safety precautions

Respect the safety guidelines for the usage of distillation apparatus, and for the handling of hydro-alcoholic and cleaning solutions.

5 Obtaining the distillate

5.1 Reagents

- 5.1.1 Type II water for analytical usage (ISO 3696 standard), or of equivalent purity
- 5.1.2 Suspension of calcium hydroxide, 12% m/v
Obtain by carefully pouring 1 L of water at 60-70 °C onto 120 g of quicklime (CaO).
- 5.1.3 Anti-foaming agent

5.2 Apparatus

Any type of distillation or steam distillation apparatus may be used provided that it satisfies the following test:

Distil a hydro-alcoholic mixture with an alcoholic strength of 10% vol. five times in succession. The distillate should have an alcoholic strength of at least 9.9% vol. after the fifth distillation, i.e. the loss of alcohol during each distillation should not be more than 0.02% vol.

By way of example, use one of the following two sets of apparatus.

- 5.2.1 Distillation apparatus, consisting of:
- a round bottomed 1-L flask with a ground-glass standard joint,
 - a rectifying column of about 20 cm in height or any system designed to prevent priming,
 - a source of heat (any pyrolysis of extracted matter should be prevented by a suitable arrangement),
 - a condenser terminated by a tapered tube taking the distillate to the bottom of a graduated receiver flask containing several mL of water.
- 5.2.2 Steam distillation apparatus consisting of:
- a steam generator,

- a bubbler,
- a rectifying column,
- a condenser.

5.3 *Preparation of the sample*

Remove the bulk of any carbon dioxide from samples with bubbles (e.g. by stirring 250 to 300 mL of the wine in a 500-mL flask).

5.4 *Procedure*

5.4.1 Procedure for beverages with an ABV greater than or equal to 1.5% vol.

Take a sample of a 200-mL volume of beverage using a calibrated flask. Note the temperature of the sample.

Pour it into the flask of the distillation apparatus or into the bubbler of the steam distillation apparatus. Rinse the calibrated flask four times with approx. 5 mL of water and add this to the apparatus' flask or bubbler.

Add approx. 10 mL 2 M calcium hydroxide ((5.1.2). If necessary, several fragments of inert porous material (e.g. pumice, etc.) and/or several drops of anti-foaming agent (5.1.3) may also be added to facilitate distillation.

Collect the distillate in the 200-mL calibrated flask used to measure the beverage. Collect a volume of about three-quarters of the initial volume if distillation is used or 198-199 mL of distillate if steam distillation is used.

Make up to 200 mL with distilled water, keeping the distillate at within ± 2 °C of the initial temperature.

Carefully mix using a circular motion.

Note: In the case of wines containing particularly large concentrations of ammonium ions, the distillate may be redistilled under the conditions described above, but replacing the suspension of calcium hydroxide with 1 mL sulphuric acid diluted to 10% (v/v).

5.4.2 Procedure for beverages with an ABV less than 1.5% vol.

Take a sample of a 200-mL volume of beverage using a calibrated flask.

Note the temperature of the beverage. Pour it into the flask of the distillation apparatus or into the bubbler of the steam distillation apparatus.

Rinse the calibrated flask four times with approx. 5 mL of water and add this to the apparatus' flask or bubbler. Add approx. 10 mL 2 M calcium hydroxide (5.1.2) and, in the case of distillation, if necessary, a boiling

COMPENDIUM OF INTERNATIONAL ANALYSIS OF METHODS-OIV
Alcoholic strength by volume – Type I and IV methods

regulating agent (e.g. pumice, etc.). In a 100-mL calibrated flask, collect a volume of distillate of about 75 mL if distillation is used or 98-99 mL of distillate if steam distillation is used.

Make up to 100 mL with distilled water, keeping the distillate at within ± 2 °C of the initial temperature. Carefully mix using a circular motion.

Part A:

**Determination of the alcoholic strength by volume of a beverage by measuring
the density of the distillate using a pycnometer
(Type I Method)**

(Method A2/1978 – Resolution 377/2009)

A.1 Principle

The density of the distillate is determined, which is matched to the ABV using the Tables.

The density is measured for a specific temperature using a glass pycnometer. This comprises a flask of known capacity, onto which a hollow ground-glass stopper is fitted equipped with a capillary tube. When the flask is closed, the overflow rises in the capillary. The volumes of the flask and the capillary being known, the density is determined by weighing using precision balances before and after filling of the pycnometer.

A.2 Reagents and products

A.2.1 Type II water for analytical usage (ISO 3696 standard), or of equivalent purity

A.2.2 Sodium chloride solution (2% m/v)

To prepare 1 litre, weigh out 20 g sodium chloride and dissolve to volume with water.

A.3 Apparatus and materials

Common laboratory apparatus, including the following:

A.3.1 Pyrex-glass pycnometer of around 100 mL capacity with a removable thermometer, with ground-glass joint and 10th-of-a-degree graduations, from 10 °C to 30 °C. This thermometer should be calibrated (Fig. 1).

Any pycnometer of equivalent characteristics may be used.

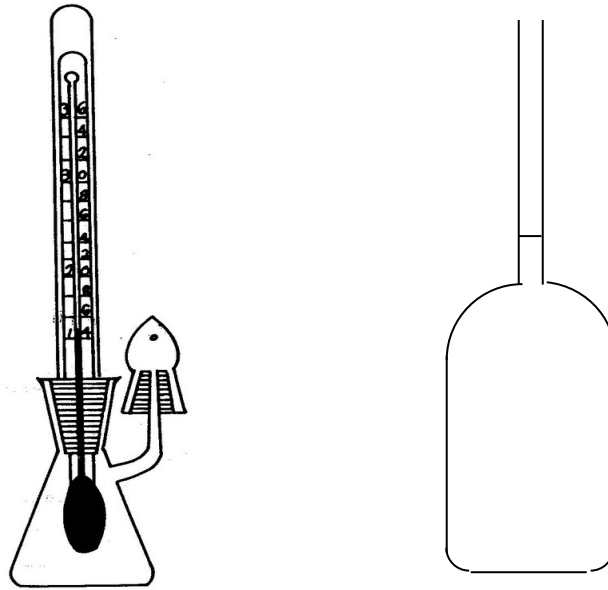

FIGURE 1: Pycnometer and its tare bottle

This pycnometer includes a side tube of 25 mm in length and an inside diameter of at most 1 mm, terminated by a ground-glass conical joint. This side tube may be capped by a 'reservoir stopper' composed of a ground-glass conical tube, terminated by a tapered joint. This stopper serves as an expansion chamber.

The two joints of the apparatus should be prepared with great care.

- A.3.2 Tare bottle of the same external volume (to within 1 mL) as the pycnometer and with a mass equal to the mass of the pycnometer filled with a liquid of a density of 1.01 (2% m/v sodium chloride solution).
- A.3.3 Thermally-insulated jacket that fits the body of the pycnometer exactly.
- A.3.4 Twin-pan balance accurate to the nearest 0.1 mg
or
single-plate balance accurate to the nearest 0.1 mg.
- A.3.5 Masses calibrated by an accredited body.

A.4 Procedure

A.4.1 Pycnometer calibration

The calibration of the pycnometer comprises the determination of the following characteristics:

- tare weight,
- volume at 20 °C,
- water mass at 20 °C.

A.4.1.1 Using a twin-pan balance

Place the tare bottle on the left-hand pan and the clean, dry pycnometer with its 'reservoir stopper' on the right-hand pan. Balance them by placing weights of known mass on the pycnometer side: p grams.

Fill the pycnometer carefully with water (A.2.1) at room temperature and fit the thermometer.

Carefully wipe the pycnometer dry and place it in the thermally-insulated jacket.

Shake by inverting the container until the thermometer's temperature reading is constant. Accurately adjust the level to the upper rim of the side tube. Wipe the side tube clean and fit the reservoir stopper.

Read the temperature, t °C, carefully and if necessary correct for any inaccuracies in the temperature scale.

Weigh the water-filled pycnometer, with the weight in grams, p , making up the equilibrium.

Calculations

- Tare of the empty pycnometer:

Tare weight = $p + m$ where m = mass of the air contained in the pycnometer, in g

$$m \text{ (g)} = 0.0012 (p - p')$$

- Volume at 20 °C in mL:

$$V_{20^\circ\text{C}} \text{ (mL)} = (p + m - p') \times F_t$$

F_t = factor for temperature, t °C, taken from Table I

$V_{20\text{ °C}}$ should be known to ± 0.001 mL

- Water mass at 20 °C:
 $M_{20\text{ °C}} = V_{20\text{ °C}} \times 0.998203$, in g
0.998203 = water density at 20 °C, in g/cm³

A.4.1.2 Using a single-pan balance

Determine:

- the mass of the clean, dry pycnometer: P,
- the mass of the water-filled pycnometer at t °C: P_1 following the instructions outlined in A.4.1.1,
- the mass of the tare bottle, T_0 .

- Calculations

Tare of the empty pycnometer:

Tare weight: $P - m$ where m (g) = mass of the air contained in the pycnometer, in g

$$m \text{ (g)} = 0.0012 (P_1 - P)$$

- Volume at 20 °C in mL:

$$V_{20\text{ °C}} \text{ (mL)} = [P_1 - (P - m)] \times F_t$$

F_t = factor for temperature, t °C, taken from Table I

$V_{20\text{ °C}}$ should be known to ± 0.001 mL.

- Water mass at 20 °C:
 $M_{20\text{ °C}} \text{ (g)} = V_{20\text{ °C}} \times 0.998203$
0.998203 = water density at 20 °C, in g/cm³

A.4.2. Determination of the density of the distillate

Measure the apparent density of the distillate at t °C using a twin-pan or single-pan balance:

A.4.2.1 Using a twin-pan balance

Weigh the pycnometer filled with the test sample following the instructions outlined in A.4.1.1.

Where p'' represents the mass in grams that makes up the equilibrium at t °C, taking into account that the liquid mass contained in the pycnometer = $p + m - p''$,

the apparent density at t °C, in g/cm³, is given by the following equation:

$$\rho_{t^{\circ}\text{C}} = \frac{p+m-p''}{V_{20^{\circ}\text{C}}}$$

A.4.2.2 Using a single-pan balance

Weigh the tare bottle, where T_1 is its mass in g.

Calculate $dT = T_1 - T_0$

Mass of the empty pycnometer at the time of measurement = $P - m + dT$, in g

Weigh the pycnometer filled with the test sample following the instructions outlined in A.4.1.1.

Where P_2 represents its mass at t °C,

the liquid mass contained in the pycnometer at t °C = $P_2 (P - m + dT)$, in g

and the apparent density at t °C, in g/cm³, is as follows:

$$\rho_{t^{\circ}\text{C}} = \frac{P_2 - (P - m + dT)}{V_{20^{\circ}\text{C}}}$$

A.5 Expression of results and precision parameters

A.5.1 Method of calculation

A.5.1.1 Beverages with an ABV greater than or equal to 1.5% vol.

Find the alcoholic strength at 20 °C in % vol. to 2 d.p. using Table I of Method OIV-MA-AS312-02A. Please note, this table uses the unit kg/m³ and not g/cm³.

The relationship is as follows: 1 g/cm³ = 1000 kg/m³.

In the horizontal line of this table corresponding to the temperature, T , (expressed as a whole number) immediately below t °C, find the smallest density greater than ρ_t . Use the tabular difference just below this density to calculate the density ρ at this temperature, T .

On the line of the temperature, T, find the density ρ' immediately above ρ and calculate the difference between the densities ρ and ρ' . Divide this difference by the tabular difference just to the right of the density ρ' . The quotient gives the decimal part of the alcoholic strength, while the whole number part of this strength is shown at the head of the column in which the density ρ' is located. An example of calculation of the alcoholic strength is given in Annex 1 to this Chapter.

Note: This temperature correction has been incorporated into a computer program and might possibly be carried out automatically.

A.5.1.2 Beverages with an ABV less than 1.5% vol.

Identical to A.5.1.1, dividing the alcoholic strength by volume of the distillate (ABVD) by 2.

$ABV = ABVD/2$, % vol. to 2 d.p.

A.6 Precision

Repeatability (r): $r = 0.10$ % vol.

Reproducibility (R) $R = 0.19$ % vol.

The validation parameters for beverages with a low alcohol content are given in Annex II.

A.7 Example of the calculation of the alcoholic strength of a wine

A.7.1 Measurement by pycnometer on a twin-pan balance

The constants of the pycnometer have been determined and calculated as described in the method **OIV-MA-AS2-01**, 'Density and specific gravity', paragraph A.7.

COMPENDIUM OF INTERNATIONAL ANALYSIS OF METHODS-OIV
Alcoholic strength by volume – Type I and IV methods

Numerical example

1. Weighing of the distillate-filled pycnometer:

$$\text{Tare} = \text{pycnometer} + \text{distillate at } t \text{ }^\circ\text{C} + p'' \quad \left\{ \begin{array}{l} t \text{ }^\circ\text{C} = 18.90 \text{ }^\circ\text{C} \\ \text{corrected } t \text{ }^\circ\text{C} = 18.70 \text{ }^\circ\text{C} \\ p'' = 2.8074 \text{ g} \end{array} \right.$$

$$p + m - p'' = \text{mass of the distillate at } t \text{ }^\circ\text{C} \quad \left\{ \begin{array}{l} 105.0698 - 2.8074 = 102.2624 \text{ g} \end{array} \right.$$

Apparent density at $t \text{ }^\circ\text{C}$:

$$\rho_t = \frac{p + m - p''}{\text{volume of the pycnometer}} \quad \left\{ \begin{array}{l} \rho_{18.7^\circ\text{C}} = \frac{102.2624}{104.0299} = 0.983076 \text{ g/cm}^3 \end{array} \right.$$

2. Calculation of the alcoholic strength:

Consult the table of apparent densities of hydro-alcoholic mixtures at different temperatures, as indicated above.

On the line 18 °C of the table of apparent densities, the smallest density greater than the observed density of 0.983076 is 0.98398, in the column 11%.

The density at 18 °C is:

$$\begin{aligned} (98307.6 + 0.7 \times 22) \cdot 10^{-5} &= 0.98323 \\ 0.98398 - 0.98323 &= 0.00075 \end{aligned}$$

The decimal portion of the alcoholic strength is: $75 / 114 = 0.65$

The alcoholic strength is: 11.65% vol.

COMPENDIUM OF INTERNATIONAL ANALYSIS OF METHODS-OIV
Alcoholic strength by volume – Type I and IV methods

A.7.2 Measurement by pycnometer on a single-pan balance

The constants of the pycnometer have been determined and calculated as described in the method **OIV-MA-AS2-01**, 'Density and specific gravity', paragraph A.7.

Numerical example

1. Weighing of the pycnometer filled with distillate:

Weight of tare bottle at the time of measurement	: T1 = 171.9178 g
Pycnometer filled with distillate at 20.50 °C	: P2 = 167.8438 g
Variation in the buoyancy of air	: $dT = 171.9178 - 171.9160$ = + 0.0018
Mass of the distillate at 20.5 °C	: $Lt = 167.8438 - (67.6695 + 0.0018)$ = 100.1725 g
Apparent density of the distillate 100.1725/101.8194 =	: $\rho_{20.5\text{ °C}} =$ 0.983825 g/cm ³

2. Calculation of alcoholic strength:

Refer to the table of apparent densities of hydro-alcoholic mixtures at

OIV-MA-AS312-01: R2021

On the line 20 °C of the table of apparent densities, the smallest density greater than the observed density of 0.983825 is 0.98471, in the column 10% vol.

The density at 20 °C is:
 $(98382.5 + 0.5 \times 24) \times 10^{-5} = 0.983945$
 $0.98471 - 0.983945 = 0.000765$

The decimal portion of the alcoholic strength is: $76.5 / 119 = 0.64$ **13**

The alcoholic strength is: 10.64% vol.

different temperatures, as indicated above.

Part B

**Determination of the alcoholic strength by volume of a beverage by measuring
the density of the distillate by electronic densimetry using a frequency
oscillator**

(Type I method)

(Resolution OENO 8/2000 – 377/2009)

B.1 Principle

In the present method the distillate density is measured by electronic densimetry using a frequency oscillator. The principle consists of measuring the period of oscillation of a tube containing the sample undergoing electromagnetic stimulation. The density is thus calculated and is linked to the period of oscillation by the following formula:

$$\rho = T^2 \times \left(\frac{C}{4\pi^2 V} \right) - \left(\frac{M}{V} \right) \quad (1).$$

ρ = density of the sample

T = period of induced vibration

M = mass of empty tube

C = spring constant

V = volume of vibrating sample

This relationship is in the form $\rho = A T^2 - B$ (2), so there is a linear relationship between the density and the period squared. The constants A and B are specific to each oscillator and are estimated by measuring the period of fluids of known density.

B.2 Reagents and products

B.2.1 Reference fluids

Two reference fluids are used to adjust the densimeter. The densities of the reference fluids should encompass the densities of the distillates to be analysed. A

spread of greater than 0.01000 g/cm^3 between the densities of the reference fluids is recommended.

The reference fluids for the determination of the ABV of vitivincultural beverages by electronic densimetry are as follows:

- dry air (unpolluted),
- Type II water for analytical usage (ISO 3696 standard), or of equivalent purity,
- hydro-alcoholic solutions of densities determined by another reference method, for which the uncertainty does not exceed 0.00005 g/cm^3 at the temperature of $20.00 \pm 0.05 \text{ }^\circ\text{C}$,
- solutions calibrated with traceability to the International System of Units (SI), with viscosities of less than $2 \text{ mm}^2/\text{s}$, for which the uncertainty does not exceed 0.00005 g/cm^3 at the temperature of $20.00 \pm 0.05 \text{ }^\circ\text{C}$.

B.2.2 Cleaning and drying products

Use products that ensure the perfectly clean and dried state of the measuring cell, according to the manufacturer's indications. For example:

- detergents, acids, etc.,
- organic solvents: 96% vol. ethanol, pure acetone, etc.

B.3 Apparatus and equipment

B.3.1 Electronic densimeter with frequency oscillator

The electronic densimeter consists of the following elements:

- a measuring cell consisting of a measuring tube and a temperature-controlled enclosure,
- a system for setting up an oscillation tube and measuring the period of oscillation,
- a digital display and possibly a calculator.

The densimeter is placed on a perfectly stable support isolated from all vibrations.

B.3.2 Temperature control of the measuring cell

Locate the measuring tube in the temperature-controlled enclosure. Temperature stability should be better than ± 0.02 °C.

It is necessary to control the temperature of the measuring cell when the densimeter makes this possible because this strongly influences the determination results. The density of a hydro-alcoholic solution with an ABV of 10% vol. is 0.98471 g/cm³ at 20 °C and 0.98447 g/cm³ at 21 °C, equating to a spread of 0.00024 g/cm³.

The test temperature is set at 20 °C. The temperature is taken at the cell level, and done with a thermometer that has a resolution accurate to 0.01 °C and is calibrated to national standards. This should enable a temperature measurement with an uncertainty of better than ± 0.07 °C.

B.3.3 Calibration of the apparatus

The apparatus should be calibrated before using it for the first time, then periodically or if the verification is not satisfactory. The objective is to use two reference fluids to calculate the constants A and B [see formula (2), B.1). To carry out the calibration in practice, refer to the user manual of the apparatus. In principle, this calibration is carried out with dry air (taking into account the atmospheric pressure) and very pure water (B.2.1).

B.3.4 Calibration verification

In order to verify the calibration, measure the density of the reference fluids.

- Every day of use, a density check of the air is carried out. A difference between the theoretical density and observed density of more than 0.00008 g/cm³ may indicate that the tube is clogged. In that case, it should be cleaned. After cleaning, verify the air density again. If the verification is not conclusive, adjust the apparatus.
- Check the density of the water; if the difference between the theoretical density and the density observed is greater than 0.00008 g/cm³, adjust the apparatus.
- If verification of the cell temperature is difficult, it is possible to directly check the density of a hydro-alcoholic solution of comparable ABV to those of the distillates analysed.

B.3.5 Checks

When the difference between the theoretical density of the reference solution (known with an uncertainty of $\pm 0.00005 \text{ g/cm}^3$) and the measured density is above 0.00008 g/cm^3 , the calibration of the apparatus should be checked.

B.4 Procedure

After obtaining a distillate, measure the density by densimetry and match to the ABV using the Tables.

Ensure the stability of the temperature of the measuring cell. The distillate in the densimeter cell should not contain air bubbles and should be homogeneous. If there is a lighting system available that makes it possible to verify the absence of bubbles, turn it off quickly after checking because the heat generated by the lamp can influence the measuring temperature.

For apparatus with a permanent lighting system, this statement is not applicable.

If the apparatus only provides the period, the density can be calculated from the A and B constants (see Annex I). If the apparatus does not provide the ABV directly, by knowing the density, obtain the ABV using the tables (Table I, OIV-MA-312-02).

B.5 Expression of results

B.5.1 Expression of results

B.5.1.1 Beverages with an ABV greater than or equal to 1.5% vol.

The alcoholic strength by volume of the beverage is obtained from the distillate. This is expressed as ‘% vol’.

If the temperature conditions are not respected, a correction should be made to express the temperature at 20 °C. The result is given to two decimal places.

B.5.1.2 Beverages with an ABV less than 1.5% vol.

Identical to B.5.1.1, dividing the alcoholic strength of the distillate (ABVD) by 2.

$ABV = ABVD/2$, % vol. to 2 d.p.

The validation parameters for beverages with a low alcohol content are given in Annex II.

B.5.2 Comments

The volume introduced into the cell should be sufficient enough to avoid possible contamination caused from the previous sample. It is thus necessary to carry out at least two tests. If these do not provide results included in the repeatability limits, a third test is necessary. In general, the results from the last two tests are homogeneous and the first value can then be eliminated.

B.6 Precision

For samples with an ABV of greater than 4% vol., the validation data and precision results are given in Annex III.

$$\text{Repeatability (r)} = 0.067 \text{ (\% vol.)}$$

$$\text{Reproducibility (R)} = 0.0454 + 0.0105 \times \text{ABV (\% vol.)}$$

For samples with an ABV of less than 4% vol. the validation data and precision results are given in Annex II.

Part C:

**Determination of the alcoholic strength by volume of a beverage by measuring
the density of the distillate by densimetry using a hydrostatic balance
(Type I Method)**

(Resolution Oeno 24/2003 – 377/2009)

C.1 Principle

The alcoholic strength by volume can be determined by densimetry using a hydrostatic balance following the Archimedes principle, by which any body immersed in a fluid experiences an upward force equal to the weight of the displaced fluid.

C.2 Reagents and products

C.2.1 Type II water for analytical usage (ISO 3696 standard), or of equivalent purity,

C.2.2 Floater-washing solution (sodium hydroxide, 30% m/v).

To prepare a 100 mL solution, weigh out 30 g of sodium hydroxide and fill to volume using 96% vol. ethanol.

C.3 Apparatus and materials

Common laboratory apparatus, including the following:

C.3.1 Single-pan hydrostatic balance with 1 mg precision.

C.3.2 Floater with at least 20 mL volume, specifically adapted for the balance, suspended by a thread with a diameter of less than or equal to 0.1 mm.

C.3.3 Cylindrical test tube with level indicator.

The floater should be able to fit entirely within the test tube volume below the level indicator; only the hanging thread should break the surface of the liquid. The cylindrical test tube should have an inside diameter at least 6 mm greater than that of the floater.

C.3.4 Thermometer (or temperature-measurement probe) with degree and 10th-of-a-degree graduations, from 10 °C to 40 °C, calibrated to ± 0.05 °C.

C.3.5 Masses calibrated by an accredited body.

C.4 Procedure

After each measurement, the floater and the test tube should be cleaned with distilled water, wiped with soft laboratory paper that does not lose its fibres and rinsed with solution whose density is to be determined. These measurements should be carried out once the apparatus has reached a stable level in order to limit alcohol loss through evaporation.

C.4.1 Apparatus calibration

C.4.1.1 Balance calibration

While balances usually have internal calibration systems, hydrostatic balances should be calibrated with weights with traceability to the International System of Units (SI).

C.4.1.2 Floater calibration

Fill the cylindrical test tube up to the level indicator with water (C.2.1) whose temperature is between 15 °C and 25 °C, but preferably at 20 °C.

Plunge the floater and the thermometer into the liquid, shake, note down the density on the apparatus and, if necessary, adjust the reading in order for it to be equal to that of the water at the measurement temperature.

C.4.1.3 Control using a hydro-alcoholic solution

Fill the cylindrical test tube up to the level indicator with a known titre of hydro-alcoholic solution at a temperature of between 15 °C and 25 °C, preferably at 20 °C.

Plunge the floater and the thermometer into the liquid, shake and note down the density on the apparatus (or the alcoholic strength if possible). The established alcoholic strength should be equal to the previously determined alcoholic strength.

Note: This solution of known alcoholic strength can also replace water for floater calibration.

C.4.2 Measurement of the density of the distillate (or alcoholic strength if possible)

Pour the test sample into the cylindrical test tube up to the level indicator.
Plunge the floater and the thermometer into the liquid, shake and note down the density on the apparatus (or the alcoholic strength if possible).
Note the temperature if the density is measured at t °C (ρ_t).
Correct ρ_t using a ρ_t density table of hydro-alcoholic mixtures (Table II in Annex I of the method OIV-MA-AS312-02 in the OIV *Compendium of International Methods of Analysis*).

C.4.3 Cleaning of the floater and cylindrical test tube

Plunge the floater into the washing solution in the test tube.
Allow to soak for one hour while turning the floater regularly.
Rinse with tap water, then with distilled water.
Wipe with soft laboratory paper that does not lose its fibres.
Carry out these operations when the floater is used for the first time and then on a regular basis as necessary.

C.5 Expression of results

C.5.1 Beverages with an ABV greater than or equal to 1.5% vol.

Using the density ρ_{20} , calculate the real alcoholic strength using the table indicating the alcoholic strength by volume (% vol.) at 20°C according to the density at 20°C of the hydro-alcoholic mixtures. This is the international table adopted by the International Organization of Legal Metrology in its Recommendation No. 22 (1973).
The values are expressed in % vol. to 2 d.p.

C.5.2 Beverages with an ABV less than or equal to 1.5% vol.

Identical to C.5.1, dividing the alcoholic strength of the distillate (ABVD) by 2.

$ABV = ABVD/2$, % vol. to 2 d.p.

The validation parameters for beverages with a low alcohol content are given in Annex II.

C.6 Precision

Repeatability (r)= 0.074 (% vol.)

COMPENDIUM OF INTERNATIONAL ANALYSIS OF METHODS-OIV
Alcoholic strength by volume – Type I and IV methods

Reproducibility (R)= 0.229 (% vol.)

Part D:

**Determination of the alcoholic strength by volume of a wine by measuring the
density of the distillate by hydrometry or refractometry
(Type IV Method)**

D.1 Principle

The alcoholic strength may be determined by densimetry using an alcoholometer following the Archimedes principle. A weighted cylinder equipped with a graduated stem is more or less immersed into the distillate whose density is to be determined. The density of the liquid is read directly on the graduation of the stem at the level of the meniscus.

D.2 Hydrometry

D.2.1 Apparatus and materials

D.2.1.1 Alcoholometer

The alcoholometer should meet the specifications for Class I or Class II alcoholometers as defined in OIML (International Organization of Legal Metrology) International Recommendation 44 “Alcoholometers and alcohol hydrometers for use in alcoholometry”.

This apparatus should be calibrated with traceability to the International System of Units (SI).

D.2.1.2 Thermometer calibrated with traceability to the International System of Units (SI) with degree and 10th-of-a-degree graduations, from 0 °C to 40 °C, calibrated to ± 0.05 °C.

D.2.1.3 Measuring cylinder with dimensions that allow for the immersion of the thermometer and the alcoholometer without contact with the sides, held vertically.

D.2.2 Procedure

Pour the distillate into the measuring cylinder, ensure that the cylinder is kept vertical, and insert the thermometer and alcoholometer. Stir and wait 1 minute to allow temperature equilibration of the measuring cylinder, the thermometer, the alcoholometer and the distillate before reading the thermometer. Remove the thermometer and, after 1 minute of rest, read the apparent alcoholic strength.

Take at least three readings from the bottom of the meniscus using a magnifying glass. Correct the apparent strength measured at t °C to account for the effect of the temperature using the Tables. The temperature of the liquid must differ very little from the room temperature (at most, by 5 °C).

D.3 Refractometry

D.3.1 Apparatus

Refractometer enabling the refractive indices in the range 1.330 to 1.346 to be measured.

Depending on the type of apparatus, measurements are taken:

- either at 20 °C, with a suitable instrument,
- or at room temperature, t °C, with a thermometer enabling the temperature to be determined to within at least 0.05 °C (a temperature correction table will be provided with the apparatus).

D.3.2 Procedure

The refractive index of the wine distillate (5) is measured by following the procedure prescribed for the type of instrument used.

D.3.3 Expression of results

Table IV in Chapter OIV-MA-AS312-02 is used to find the alcoholic strength corresponding to the refractive index at 20 °C.

Note: Table IV gives the alcoholic strengths corresponding to the refractive indices for both pure hydro-alcoholic mixtures and for wine distillates. In the case of wine distillates, it takes into account the presence of impurities in the distillate (mainly higher alcohols). The presence of methanol lowers the refractive index and thus the alcoholic strength.

Note: To obtain the alcoholic strength from the density of the distillate, use Tables I, II and III in Chapter OIV-MA-AS312-02. These have been calculated from the international alcoholometric tables published in 1972 by the International Organization of Legal Metrology in its Recommendation No. 22 and adopted by the OIV.

7. Annexes

ANNEX I

Formula for the calculation of alcoholic strength tables for mixtures of ethanol and water.

The density, ρ , expressed in kilograms per cubic metre (kg/m^3) of a mixture of ethanol and water at the temperature t , expressed in degrees Celsius, is given by the following formula, according to the following:

- the mass concentration p , expressed by a decimal number (*),
- the temperature t , expressed in degrees Celsius (IPTS 68),
- the numerical coefficients in the tables below.

The formula is valid for temperatures of between $-20\text{ }^\circ\text{C}$ and $+40\text{ }^\circ\text{C}$.

$$\rho = A_1 + \sum_{k=2}^{12} A_k p^{k-1} + \sum_{k=1}^6 B_k (t - 20\text{ }^\circ\text{C})^k + \sum_{i=1}^n \sum_{k=1}^m C_{i,k} p^k (t - 20\text{ }^\circ\text{C})^i$$
$$n = 5, m_1 = 11, m_2 = 10, m_3 = 9, m_4 = 4, m_5 = 2$$

(*) E.g. For a mass concentration of 12%, $p = 0.12$.

Numeric coefficients for the formula

COMPENDIUM OF INTERNATIONAL ANALYSIS OF METHODS-OIV
Alcoholic strength by volume – Type I and IV methods

k	A_k kg/m ³	B_k
1	9,982 012 300 · 10 ²	-2,061 851 3 · 10 ⁻¹ kg/(m ³ · °C)
2	-1,929 769 495 · 10 ²	-5,268 254 2 · 10 ⁻³ kg/(m ³ · °C ²)
3	3,891 238 958 · 10 ²	3,613 001 3 · 10 ⁻⁵ kg/(m ³ · °C ³)
4	-1,668 103 923 · 10 ³	-3,895 770 2 · 10 ⁻⁷ kg/(m ³ · °C ⁴)
5	1,352 215 441 · 10 ⁴	7,169 354 0 · 10 ⁻⁹ kg/(m ³ · °C ⁵)
6	-8,829 278 388 · 10 ⁴	-9,973 923 1 · 10 ⁻¹¹ kg/(m ³ · °C ⁶)
7	3,062 874 042 · 10 ⁵	
8	-6,138 381 234 · 10 ⁵	
9	7,470 172 998 · 10 ⁵	
10	-5,478 461 354 · 10 ⁵	
11	2,234 460 334 · 10 ⁵	
12	-3,903 285 426 · 10 ⁴	

k	$C_{1,k}$ kg/(m ³ · °C)	$C_{2,k}$ kg/(m ³ · °C ²)
1	1,693 443 461 530 087 · 10 ⁻¹	-1,193 013 005 057 010 · 10 ⁻¹
2	-1,046 914 743 455 169 · 10 ¹	2,517 399 633 803 46 1 · 10 ⁻¹
3	7,196 353 469 546 523 · 10 ¹	-2,170 575 700 536 993
4	-7,047 478 054 272 792 · 10 ²	1,353 034 988 843 029 · 10 ¹
5	3,924 090 430 035 045 · 10 ³	-5,029 988 758 547 014 · 10 ¹
6	-1,210 164 659 068 747 · 10 ⁴	1,096 355 666 577 570 · 10 ²
7	2,248 646 550 400 788 · 10 ⁴	-1,422 753 946 421 155 · 10 ²
8	-2,605 562 982 188 164 · 10 ⁴	1,080 435 942 856 230 · 10 ²
9	1,852 373 922 069 467 · 10 ⁴	-4,414 153 236 817 392 · 10 ²
10	-7,420 201 433 430 137 · 10 ³	7,442 971 530 188 783
11	1,285 617 841 998 974 · 10 ³	

k	$C_{3,k}$ kg/(m ³ · °C ³)	$C_{4,k}$ kg/(m ³ · °C ⁴)	$C_{5,k}$ kg/(m ³ · °C ⁵)
1	-6,802 995 733 503 803 · 10 ⁻⁴	-4,075 376 675 622 027 · 10 ⁻⁷	-2,788 074 354 782 409 · 10 ⁻⁸
2	-1,876 837 790 289 664 · 10 ⁻²	-8,763 058 573 471 110 · 10 ⁻⁷	1,345 612 883 493 354 · 10 ⁻⁸
3	-2,002 561 813 734 156 · 10 ⁻¹	6,515 031 360 099 368 · 10 ⁻⁸	
4	-1,022 992 966 719 220	-1,515 784 836 987 210 · 10 ⁻⁸	
5	-2,895 696 483 903 638		
6	-4,810 060 584 300 675		
7	-4,672 147 440 794 683		
8	-2,458 043 105 903 461		
9	-5,411 227 621 436 812 · 10 ⁻¹		

ANNEX II

**Validation parameters relating to the measurement of the ABV of beverages
with a low alcohol content**

This document presents the results of the validation study for the method for beverages with a low alcohol content (update).

The study was carried out in accordance with documents OIV MA-F-AS1-08-FIDMET and MA-F-AS1-09-PROPER.

1. Sample

Sample no.	1	2	3	4	5	6
Nature	Grape juice	Beverage obtained by dealcoholisation of wine	Beverage obtained by partial dealcoholisation of wine	Partially fermented grape juice	Cider	Wine-based beverage
Approximate ABV in %vol.	< 0.5	0.5	1.5	2.5	4.5	6.5

Table 1: Samples analysed for the validation

2. Analyses

Each of the 12 samples received by the laboratories were analysed by simple distillation or by steam distillation according to the following two procedures:

- OIV reference method with use of 200 mL and recovery of 200 mL of distillate,
- Alternative method with use of 200 mL and recovery of 100 mL of distillate.

COMPENDIUM OF INTERNATIONAL ANALYSIS OF METHODS-OIV
Alcoholic strength by volume – Type I and IV methods

3. Participating laboratories

19 laboratories from different countries took part:

Laboratório CVRVV	4050-501 Porto	Portugal
Laboratório de Análises da CVRA	7006-806 Évora	Portugal
Testing Laboratory CAFIA	603 00 BRNO	Czech Republic
Laboratório ASAE - LBPV	1649-038 Lisboa	Portugal
Agroscope - Site de Changins	1260 Nyon 1	Switzerland
Labo SCL de Bordeaux	33608 Pessac	France
Labo SCL de Montpellier	34196 Montpelllier	France
Laboratorio Arbitral Agroalimentario	28023 Madrid	Spain
Estación Enológica de Haro	26200 Haro La Rioja	Spain
Instituto dos Vinho do Douro do Porto	Porto 4050-253	Portugal
IVICAM	13700 Tomelloso, Ciudad Real	Spain
INCAVI	08720 Vilafranca del Penedès	Spain
ICQRF Laboratorio di Conegliano/Susegana	31058 SUSEGANA (TV)	Italy
ICQRF Laboratorio di Catania	95122 CATANIA	Italy
ICQRF Laboratorio di Modena	41100 Modena	Italy
ICQRF laboratorio di Perugia	06128 Perugia	Italy
ICQRF laboratorio di Salerno	84098 Salerno	Italy
ICQRF Laboratorio centrale di Roma	00149 Rome	Italy
Laboratoires DUBERNET	11100 Narbonne	France

Table 2: Laboratories that took part in the validation

COMPENDIUM OF INTERNATIONAL ANALYSIS OF METHODS-OIV
Alcoholic strength by volume – Type I and IV methods

4. Results

	Sample No. 1	Sample No. 2	Sample No. 3	Sample No. 4	Sample No. 5	Sample No. 6						
LAB	POSITION :											
	2	7	4	11	6	12	5	8	9	10	1	3
A	0.21	0.21	0.55	0.55	1.34	1.34	2.58	2.58	4.59	4.60	6.54	6.50
B	0.11	0.14	0.49	0.50	1.32	1.38	2.60	2.57	4.68	4.72	6.52	6.55
C	0.33	0.28	0.68	0.61	1.43	1.35	2.63	2.60	4.63	4.66	6.58	6.51
D			0.62	0.62	1.38	1.36	2.68	2.67	4.69	4.73	6.62	6.64
E	0.20	0.21	0.55	0.56	1.36	1.40	2.61	2.62	4.67	4.68	6.56	6.55
F	0.18	0.12	0.52	0.51	1.31	1.30	2.56	2.56	4.70	4.66	6.51	6.54
G	0.22	0.22	0.55	0.56	1.37	1.37	2.62	2.62	4.68	4.68	6.58	6.57
H			0.41	0.42	1.25	1.27	2.46	2.49	4.57	4.56	6.39	6.40
I	0.20	0.13	0.54	0.48	1.32	1.28	2.60	2.58	4.62	4.62	6.57	6.55
J	0.24	0.24	0.58	0.60	1.41	1.37	2.63	2.63	4.69	4.67	6.55	6.55
K	0.22	0.22	0.56	0.55	1.35	1.35	2.63	2.63	4.67	4.68	6.59	6.58
L	0.22	0.23	0.56	0.57	1.38	1.36	2.63	2.61	4.66	4.67	6.56	6.57
M	0.18	0.18	0.53	0.53	1.33	1.29			4.66	4.65	6.53	6.52
N	0.22	0.23	0.56	0.57	1.38	1.41	2.26	2.61	4.67	4.67	6.51	6.57
O	0.12	0.19	0.53	0.52	1.33	1.33	2.64	2.62	4.67	4.67	6.51	6.55
P	0.25	0.25	0.57	0.58	1.39	1.41	2.66	2.65	4.70	4.68	6.62	6.62
Q	0.22	0.20	0.55	0.59	1.34	1.33	2.61	2.63	4.65	4.63	6.52	6.54
R	0.21	0.21	0.55	0.52	1.29	1.28	2.52	2.55	4.62	4.56	6.50	6.53
S	0.18	0.17	0.41	0.42	1.38	1.37	2.61	2.58	4.63	4.58	6.51	6.48

Table 3: Results obtained for a 200 mL distillation with recovery volume of 200 mL

Results not presented were rejected in accordance with the Cochran (variance outliers) test with a 2.5% significance level (one-tailed test) and the Grubbs (outliers from the mean) test with significance levels of 2.5% (two-tailed test).

Note: The absent values have not been provided by the laboratory in question.

COMPENDIUM OF INTERNATIONAL ANALYSIS OF METHODS-OIV
Alcoholic strength by volume – Type I and IV methods

	Sample No. 1	Sample No. 2	Sample No. 3	Sample No. 4	Sample No. 5	Sample No. 6						
LAB	POSITION :											
	2	7	4	11	6	12	5	8	9	10	1	3
A												
B	0.17	0.18	0.52	0.53	1.34	1.36	2.62	2.62	4.62	4.60	6.48	6.52
C	0.25	0.25	0.56	0.62	1.35	1.36	2.50	2.46	4.48	4.44	6.12	6.19
D	0.29	0.29	0.63	0.63	1.43	1.42	2.66	2.65	4.68	4.69	6.58	6.59
E	0.24	0.24	0.58	0.58	1.39	1.39	2.64	2.64	4.66	4.67	6.55	6.57
F	0.21	0.18	0.53	0.53	1.31	1.27	2.41	2.48	4.30	4.31	6.22	5.89
G	0.24	0.24	0.56	0.57	1.35	1.36	2.58	2.57	4.57	4.56	6.46	6.43
H	0.19	0.18	0.48	0.55	1.33	1.32	2.51	2.55	4.59	4.54	6.38	6.42
I	0.25	0.18	0.56	0.53	1.34	1.33	2.62	2.61	4.64	4.64	6.25	6.28
J	0.24	0.24	0.55	0.56	1.31	1.32	2.49	2.53	4.37	4.34	6.14	6.12
K	0.25	0.25	0.57	0.57	1.37	1.38	2.60	2.61	4.60	4.61	6.48	6.38
L	0.24	0.24	0.55	0.55	1.35	1.31	2.52	2.47	4.38	4.31	6.09	6.06
M	0.19	0.20	0.55	0.55	1.34	1.31			4.68	4.67	6.52	6.54
N	0.28	0.26	0.58	0.59	1.28	1.28	2.52	2.47	4.44	4.32	6.01	6.15
O	0.19	0.25	0.57	0.57	1.39	1.39	2.63	2.64	4.66	4.66	6.57	6.57
P	0.25	0.26	0.57	0.57	1.36	1.36	2.58	2.56	4.54	4.53	6.34	6.38
Q	0.24	0.24	0.57	0.57	1.38	1.38	2.63	2.62	4.66	4.67	6.56	6.56
R	0.23	0.23	0.54	0.55	1.32	1.30	2.54	2.56	4.56	4.52	6.40	6.35
S	0.27	0.26	0.55	0.57	1.34	1.34	2.46	2.43	4.53	4.51	6.36	6.36

Table 4: Results obtained for a 200 mL distillation with recovery volume of 100 mL

Results not presented were rejected in accordance with the Cochran (variance outliers) test with a 2.5% significance level (one-tailed test) and the Grubbs (outliers from the mean) test with significance levels of 2.5% (two-tailed test).

Note: The absent values have not been provided by the laboratory in question.

COMPENDIUM OF INTERNATIONAL ANALYSIS OF METHODS-OIV
Alcoholic strength by volume – Type I and IV methods

	Sample 1	Sample 2	Sample 3	Sample 4	Sample 5	Sample 6
No. of laboratories selected	17	19	19	17	19	18
No. of repetitions	2	2	2	2	2	2
Minimum	0.11	0.41	1.25	2.46	4.56	6.48
Maximum	0.33	0.68	1.43	2.68	4.73	6.64
Overall average	0.20	0.54	1.35	2.60	4.65	6.55
Repeatability variance	0.00052	0.00033	0.00050	0.00019	0.00036	0.00047
Reproducibility variance	0.00211	0.00345	0.00190	0.00229	0.00181	0.00147
Inter-laboratory standard deviation	0.043	0.057	0.041	0.047	0.040	0.035
Repeatability standard deviation	0.02	0.02	0.02	0.01	0.02	0.02
r limit	0.06	0.05	0.06	0.04	0.05	0.061
Repeatability CV	11.1	3.3	1.7	0.5	0.4	0.3
Reproducibility standard deviation	0.046	0.059	0.044	0.048	0.043	0.038
R limit	0.130	0.166	0.123	0.135	0.120	0.109
Reproducibility CV	22.5	10.9	3.2	1.8	0.9	0.6
Horwitz RSD _r	3.36	2.90	2.52	2.29	2.09	1.99
Horrat _r	3.3	1.1	0.7	0.2	0.2	0.2
Horwitz RSD _R	5.10	4.39	3.82	3.46	3.17	3.01
Horrat _R	4.4	2.5	0.8	0.5	0.3	0.2

Table 5: Data obtained for a 200 mL distillate from a 200 mL sample

COMPENDIUM OF INTERNATIONAL ANALYSIS OF METHODS-OIV
Alcoholic strength by volume – Type I and IV methods

	Sample 1	Sample 2	Sample 3	Sample 4	Sample 5	Sample 6
No. of laboratories selected	16	15	18	17	17	17
No. of repetitions	2	2	2	2	2	2
Minimum	0.17	0.52	1.27	2.41	4.30	6.01
Maximum	0.29	0.63	1.43	2.66	4.69	6.59
Overall average	0.24	0.56	1.35	2.56	4.55	6.38
Repeatability variance	0.00006	0.00003	0.00016	0.00050	0.00039	0.00135
Inter-laboratory standard deviation	0.03209	0.02496	0.03752	0.07013	0.12167	0.17621
Reproducibility variance	0.001	0.001	0.001	0.005	0.015	0.031
Repeatability standard deviation	0.01	0.01	0.01	0.02	0.02	0.04
r limit	0.02	0.02	0.04	0.06	0.06	0.104
Repeatability CV	3.2	1.0	0.9	0.9	0.4	0.6
Reproducibility standard deviation	0.033	0.025	0.039	0.072	0.122	0.178
R limit	0.092	0.071	0.109	0.203	0.347	0.504
Reproducibility CV	13.8	4.5	2.9	2.8	2.7	2.8
Horwitz RSD _r	3.27	2.88	2.52	2.29	2.10	2.00
Horrat _r	1.0	0.4	0.4	0.4	0.2	0.3
Horwitz RSD _R	4.96	4.36	3.82	3.47	3.18	3.03
Horrat _R	2.8	1.0	0.8	0.8	0.9	0.9

Table 6: Data obtained for a 100 mL distillate from a 200 mL sample

Annex III
Validation parameters relating to the measurement of the ABV
by electronic densimetry (Part B)

1. Inter-laboratory tests: precision and accuracy on additions

1.1 Samples

The samples used for this joint study are described in Table 7.

No.	Nature	Approximate ABV (% vol.)
C0	Cider (filtered through a membrane to remove CO ₂)	~5
V0	Filtered wine	~10
V1	Filtered wine then doped	~11
V2	Filtered wine then doped	~12
V3	Filtered wine then doped	~13
P0	Liqueur wine	~16

Table 7: Samples for the joint study

All samples were homogenised before filling the bottles to be sent to the participants. For wine, 40 litres were homogenised before sending and carrying out the additions.

For the additions, absolute ethanol was poured into a 5-L volumetric flask, then filled up to the line with filtered wine. This was repeated two times. The volumes of ethanol were 50, 100 and 150 mL respectively for the V1, V2 and V3 samples.

1.2 Participating laboratories

The participating laboratories in the joint study are outlined in Table 8.

Laboratory	Postcode	City
ALKO Group LTD	FIN-00101	Helsinki
Bénédictine	76400	Fécamp
Casanis	18881	Gemenos
CIVC	51200	Epernay
Cointreau	49181	St Barthélémy d'Anjou
Courvoisier	16200	Jarnac
Hennessy	16100	Cognac
IDAC	44120	Vertou
Laboratoire Gendrot	33000	Bordeaux
Martell	16100	Cognac
Ricard	94320	Thiais
SOEC Martin Vialatte	51319	Epernay

Table 8: List of laboratories participating in the joint study

In order to not introduce a methodological bias, the results of the Station Viticole du Bureau National Interprofessionnel du Cognac (the joint-study organiser) are not taken into account.

1.2.1 Analyses

The C0 and P0 products were distilled independently two times, and the V0, V1, V2 and V3 products three times. Three ABV tests were done for each distillate. The results are displayed in the results table.

1.2.2 Results

The second test (out of the three carried out) was kept for the precision study (Table 9).

COMPENDIUM OF INTERNATIONAL ANALYSIS OF METHODS-OIV
Alcoholic strength by volume – Type I and IV methods

Laboratory	C0	V0	V1	V2	V3	P0
1	6.020	9.500	10.390	11.290	12.100	17.080
	5.970	9.470	10.380	11.260	12.150	17.080
		9.450	10.340	11.260	12.150	
2	6.040	9.500	10.990	11.270	12.210	17.050
	6.040	9.500	10.390	11.280	12.210	17.050
		9.510	10.400	11.290	12.200	
3	5.960	9.460	10.350	11.280	12.170	17.190
	5.910	9.460	10.360	11.280	12.150	17.200
		9.450	10.340	11.260	12.170	
4	6.020	9.470	10.310	11.250	12.160	16.940
	6.020	9.450	10.350	11.250	12.120	17.070
		9.450	10.330	11.210	12.130	
5	5.950	9.350	10.250	11.300	12.050	17.000
	5.950	9.430	10.250	11.300	12.050	17.000
		9.430	10.250	11.300	12.050	
6	6.016	9.513	10.370	11.275	12.222	17.120
	6.031	9.513	10.336	11.266	12.222	17.194
		9.505	10.386	11.275	12.220	
7	5.730	9.350	10.230	11.440	12.080	17.010
	5.730	9.430	10.220	11.090	12.030	16.920
		9.460	10.220	11.080	11.930	
8	5.990	9.400	10.340	11.160	12.110	17.080
	6.000	9.440	10.320	11.150	12.090	17.110
		9.440	10.360	11.210	12.090	
9	6.031	9.508	10.428	11.289	12.180	17.089
	6.019	9.478	10.406	11.293	12.215	17.084
		9.509	10.411	11.297	12.215	
10	6.030	9.500	10.380	11.250	12.150	17.130
	6.020	9.510	10.380	11.250	12.150	17.100
		9.510	10.380	11.250	12.160	
11	6.020	9.480	10.400	11.260	12.150	17.040
	6.000	9.470	10.390	11.260	12.140	17.000

COMPENDIUM OF INTERNATIONAL ANALYSIS OF METHODS-OIV
Alcoholic strength by volume – Type I and IV methods

9.490	10.370	11.240	12.160
-------	--------	--------	--------

Table 9: Results (second test per distillate) (% vol.)

1.2.3 Repeatability and reproducibility calculations

The repeatability and reproducibility calculations were carried out in compliance with the standard NF X 06-041, September 1983, ISO 5725. Table 10 presents the standard deviation per cell (laboratory x sample).

Laboratory	C0	V0	V1	V2	V3	P0
1	0.0354	0.0252	0.0265	0.0173	0.0289	0.0000
2	0.0000	0.0058	0.3436	0.0100	0.0058	0.0000
3	0.0354	0.0058	0.0100	0.0115	0.0115	0.0071
4	0.0000	0.0115	0.0200	0.0231	0.0208	0.0919
5	0.0000	0.0462	0.0000	0.0000	0.0000	0.0000
6	0.0106	0.0046	0.0255	0.0052	0.0012	0.0523
7	0.0000	0.0569	0.0058	0.2050	0.0764	0.0636
8	0.0071	0.0231	0.0200	0.0321	0.0115	0.0212
9	0.0085	0.0176	0.0115	0.0040	0.0202	0.0035
10	0.0071	0.0058	0.0000	0.0000	0.0058	0.0212
11	0.0141	0.0100	0.0153	0.0115	0.0100	0.0283

Table 10: Dispersion table (standard deviation in % vol.)

Three cells presented strong dispersions (probability with Cochran test under 1%). These cells are represented in grey (Table 10). For laboratory 7 and the V3 product, the standard deviation of 0.0764 was maintained despite the Cochran test because it is on the same high level as that observed at the same laboratory for the V0 product.

COMPENDIUM OF INTERNATIONAL ANALYSIS OF METHODS-OIV
Alcoholic strength by volume – Type I and IV methods

An examination of the figures for each distillate (Table 9) led to the elimination of the following:

- laboratory 2, product V1, value 10.990,
- laboratory 7, product V2, value 11.440.

After eliminating these two values, the cell averages were calculated (laboratory x sample). The results are presented in Table 11.

Laboratory	C0	V0	V1	V2	V3	P0
1	5.9950	9.4733	10.3700	11.2700	12.1333	17.0800
2	6.0400	9.5033	10.3950	11.2800	12.2067	17.0500
3	5.9350	9.4567	10.3500	11.2733	12.1633	17.1950
4	6.0200	9.4567	10.3300	11.2367	12.1367	17.0050
5	5.9500	9.4033	10.2500	11.3000	12.0500	17.0000
6	6.0235	9.5103	10.3640	11.2720	12.2213	17.1570
7	5.7300	9.4133	10.2233	11.0850	12.0133	16.9650
8	5.9950	9.4267	10.3400	11.1733	12.0967	17.0950
9	6.0250	9.4983	10.4150	11.2930	12.2033	17.0865
10	6.0250	9.5067	10.3800	11.2500	12.1533	17.1150
11	6.0100	9.4800	10.3867	11.2533	12.1500	17.0200

Table 11: Table of averages (means in % vol.)

The figures given by laboratory 7 are generally low (Table 11). In the case of cider, the average for this laboratory is very far from the figures of the other laboratories (probability with the Dixon test under 1%). This laboratory's results for this product were eliminated.

Table 12 presents the calculated repeatability and reproducibility.

Sample	P	n	ABV	S ² r	S ² L	r	R
1 _{C0}	10	20	6.002	0.000298	0.001033	0.049	0.103
V0	11	33	9.466	0.000654	0.001255	0.072	0.124

COMPENDIUM OF INTERNATIONAL ANALYSIS OF METHODS-OIV
Alcoholic strength by volume – Type I and IV methods

V1	11	32	10.344	0.000255	0.003485	0.045	0.173
V2	11	32	11.249	0.000219	0.003113	0.042	0.163
V3	11	33	12.139	0.000722	0.003955	0.076	0.194
P0	11	22	17.070	0.001545	0.004154	0.111	0.214

Table 12: Repeatability and reproducibility calculations

Key:

p: number of laboratories retained

n: number of values retained

ABV: mean ABV (% vol.)

S²r: repeatability variance (% vol.)²

S²L: interlaboratory variance (% vol.)²

r: repeatability (% vol.)

R: reproducibility (% vol.)

Reproducibility increases with the sample's ABV (Figure 2). The increase in repeatability according to ABV is less noticeable and the overall repeatability was calculated according to the mean repeatability variance. As such, for the samples with an ABV of between 4 and 18% vol.,

Repeatability (r) = 0.067 (% vol.),

Reproducibility (R) = 0.0454 + 0.0105 x ABV.

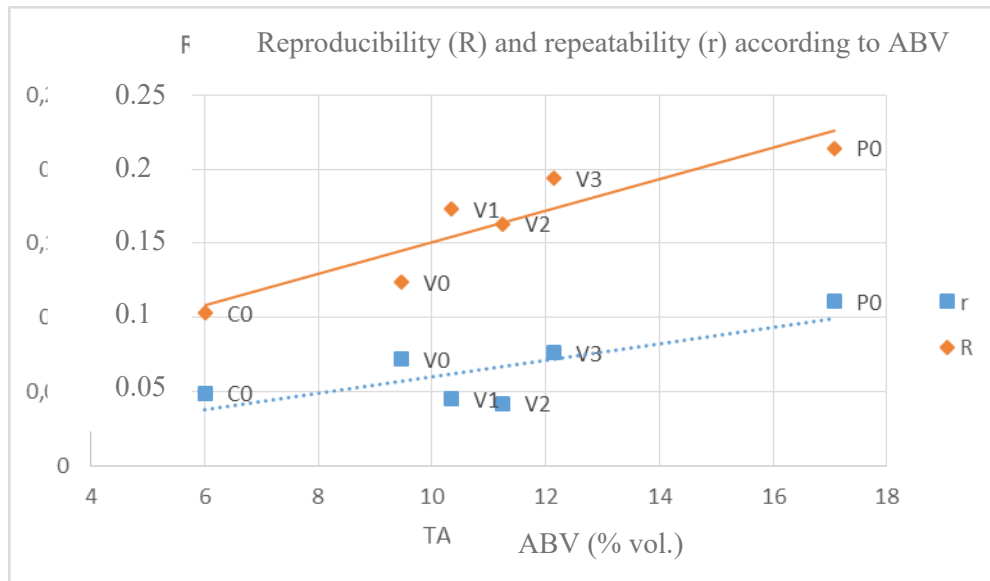

Figure 2: Repeatability and reproducibility according to ABV

1.2.4 Accuracy with regard to additions carried out on wine

The regression line of alcoholic strength after addition according to the volume of ethanol added provides, for a volume of 0 mL, an estimation of the initial alcoholic strength of the product (Figure 3). This regression is carried out with mean values for each laboratory (Table 11).

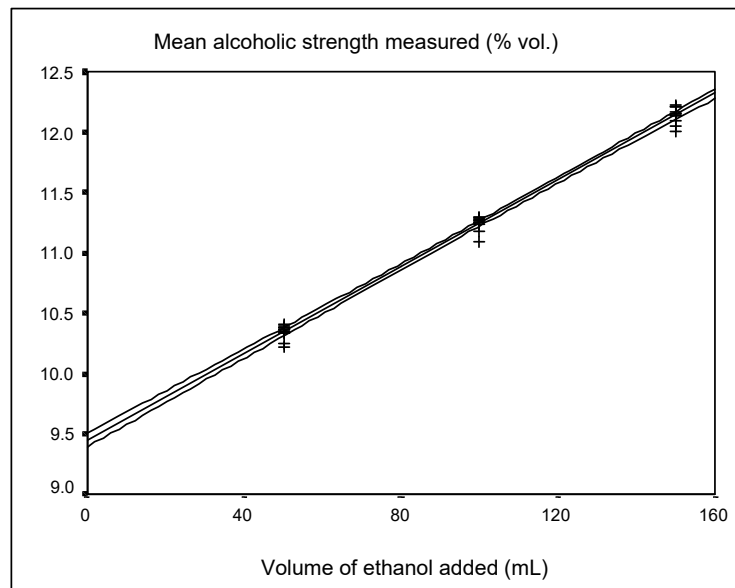

Figure 3: Regression of ABV measured by volume of ethanol added

Measurements carried out on initial products are not included in this estimation. This estimation was compared with the mean of the measurements taken on this product before additions; the intervals of relative confidence on these two estimations were calculated (Table 13).

LB	mean of measurements	UB	LB	estimation with measurements of products + additions	UB
9.440	9.466	9.492	9.392	9.450	9.508

Table 13: Additions to products

COMPENDIUM OF INTERNATIONAL ANALYSIS OF METHODS-OIV
Alcoholic strength by volume – Type I and IV methods

Key:

LB: lower bound of confidence interval at 95%

UB: upper bound of confidence level at 95%

The two confidence intervals cover a large overlapping centre. Thanks to the measurements on 'doped' samples, the alcoholic strength by volume of the initial product could be found.

1.2.5 Conclusion of inter-laboratory tests

The repeatability and reproducibility indications by inter-laboratory tests provide the following equations, for products with ABVs of between 4% and 18% vol.:

Repeatability (r) = 0.067 (% vol.),

Reproducibility (R) = 0.0454 + 0.0105 x ABV (% vol.).

The Horwitz indicators, Hor and HoR, are low (Table 14). This therefore indicates good precision of the method in relation to the analyte measured.

Sample	C0	V0	V1	V2	V3	P0
n	20	33	32	32	33	22
p	10	11	11	11	11	11
ABV	6.0019	9.4662	10.3443	11.2492	12.1389	17.0699
r	0.0489	0.0724	0.0452	0.0419	0.0760	0.1113
sr	0.0173	0.0256	0.0160	0.0148	0.0269	0.0393
RSDr	0.2878	0.2702	0.1543	0.1316	0.2214	0.2303
RSDrH	2.0159	1.8822	1.8573	1.8340	1.8131	1.7224
Hor	0.1428	0.1436	0.0831	0.0718	0.1221	0.1337
R	0.1033	0.1237	0.1731	0.1634	0.1935	0.2136
sR	0.0365	0.0437	0.0612	0.0577	0.0684	0.0755
RSDR	0.6080	0.4616	0.5912	0.5131	0.5634	0.4423
RSDRH	3.0543	2.8519	2.8141	2.7788	2.7471	2.6097
HoR	0.1991	0.1619	0.2101	0.1847	0.2051	0.1695

Table 14: Summary table of method precision

Key:

COMPENDIUM OF INTERNATIONAL ANALYSIS OF METHODS-OIV
Alcoholic strength by volume – Type I and IV methods

<i>n</i> :	<i>number of values retained</i>
<i>p</i> :	<i>number of laboratories retained</i>
<i>ABV</i> :	<i>mean ABV (% vol.)</i>
<i>r</i> :	<i>repeatability (% vol.)</i>
<i>sr</i> :	<i>repeatability standard deviation (% vol.)</i>
<i>RSDr</i> :	<i>repeatability coefficient of variation ($sr \times 100 / ABV$) (%)</i>
<i>RSDrH</i> :	<i>Horwitz repeatability coefficient of variation ($0.66 \times RSDrH$) (%)</i>
<i>Hor</i> :	<i>Horrat repeatability value ($RSDr/RSDrH$)</i>
<i>R</i> :	<i>reproducibility (% vol.)</i>
<i>sR</i> :	<i>reproducibility standard deviation (% vol.)</i>
<i>RSDR</i> :	<i>reproducibility coefficient of variation ($sR \times 100 / ABV$) (%)</i>
<i>RSDRH</i> :	<i>Horwitz reproducibility coefficient of variation ($2^{(1-0.5\log(ABV))}$) (%)</i>
<i>HoR</i> :	<i>Horrat reproducibility value ($RSDR/RSDRH$)</i>

The measurements carried out during inter-laboratory tests on wine with additions made it possible to find the value obtained before the addition. The values 9.45% and 9.47% vol. were found respectively.

Annex IV

Comparison of measurements carried out using a hydrostatic balance (Method C) with those obtained by electronic densimetry (Méthode B)

Using samples with alcoholic strengths between 4% vol. and 18% vol., the repeatability and reproducibility were measured using an inter-laboratory test. The alcoholic strength of the different samples as measured using a hydrostatic balance and using electronic densimetry were compared, including the repeatability and reproducibility values derived from the multi-year inter-comparison tests performed on a large scale.

1. *Samples:* Wines with different densities and alcoholic strengths prepared monthly on an industrial scale, taken from a stock of bottles stored under normal conditions, and supplied anonymously to the laboratories.
2. *Laboratories:* Laboratories participating in the monthly tests organised by *Unione Italiana Vini* (Verona, Italy) according to ISO 5725 (UNI 9225) regulations and the International Harmonized Protocol for the Proficiency Testing of Analytical Chemical Laboratories produced by the AOAC, ISO and IUPAC (J. AOAC Intern., 1993, 74/4), and ISO 43 and ILAC G13 guidelines. An annual report is provided by the above-mentioned organisation to all participants.
3. *Apparatus:*
 - An electronic hydrostatic balance (with precision to 5 decimal places), equipped if possible with a data-processing device.
 - An electronic densimeter, equipped if possible with an autosampler.
4. *Analyses*

The measurement of the distillate was repeated twice.
5. *Results*

Table 15 shows the results of the measurements obtained by the laboratories using a hydrostatic balance.

Table 16 shows the results obtained by the laboratories using an electronic densimeter.

6. *Evaluation of results*

Interlaboratory reproducibility

A Horrat value of 1 usually indicates satisfactory interlaboratory reproducibility, whereas a value of more than 2 normally indicates unsatisfactory reproducibility, i.e. one that is too variable for analytical purposes or where the variation obtained is greater than that expected for the type of method employed. Hor is also calculated and used to assess interlaboratory reproducibility, using the following approximation:

$$\text{RSDr (Horwitz)} = 0.66 \text{ RSDR (Horwitz)} \text{ (this assumes the approximation that } r = 0.66 R \text{).}$$

Table 17 shows the differences between the measurements obtained by laboratories using an electronic densimeter and those using a hydrostatic balance. Excluding the sample 2000/3, which has a very low alcohol strength and for which both techniques show poor reproducibility, good concordance is generally observed for the other samples.

7. *Precision parameters*

Table 18 shows the overall averages of the precision parameters calculated from all monthly tests carried out between January 1999 and May 2001.

In particular:

Repeatability (r) = 0.074 (% vol.) for the hydrostatic balance and
 0.061 (% vol.) for electronic densimetry,

Reproducibility (R) = 0.229 (% vol.) for the hydrostatic balance and
 0.174 (% vol.) for electronic densimetry.

COMPENDIUM OF INTERNATIONAL ANALYSIS OF METHODS-OIV
Alcoholic strength by volume – Type I and IV methods

Table 15: Hydrostatic balance (HB)

	mean	n	outliers	n1	r	sr	RSDr	Hor	R	sR	RSDR	HoR	no. of replicates	difference
1999/1	11.043	17	1	16	0.0571	0.0204	0.1846	0.1004	0.1579	0.0564	0.5107	0.18	2	0.108
1999/2	11.247	14	1	13	0.0584	0.0208	0.1854	0.1011	0.1803	0.0644	0.5727	0.21	2	0.1241
1999/3	11.946	16	0	16	0.0405	0.0145	0.1211	0.0666	0.1593	0.0569	0.4764	0.17	2	0.1108
1999/4	7.653	17	1	16	0.0502	0.0179	0.2344	0.1206	0.1537	0.0549	0.7172	0.24	2	0.1057
1999/5	11.188	17	0	17	0.0871	0.0311	0.278	0.1515	0.2701	0.0965	0.8622	0.31	2	0.186
1999/6	11.276	19	0	19	0.0846	0.0302	0.268	0.1462	0.2957	0.1056	0.9365	0.34	2	0.2047
1999/7	8.018	17	0	17	0.089	0.0318	0.3964	0.2054	0.2573	0.0919	1.1462	0.39	2	0.1764
1999/9	11.226	17	0	17	0.058	0.0207	0.1846	0.1423	0.2796	0.0999	0.8896	0.45	2	0.1956
1999/10	11.026	17	0	17	0.0606	0.0216	0.1961	0.1066	0.2651	0.0947	0.8588	0.31	2	0.185
1999/11	7.701	16	1	15	0.0643	0.0229	0.298	0.1535	0.233	0.0832	1.0805	0.37	2	0.1616
1999/12	10.987	17	2	15	0.0655	0.0234	0.2128	0.1156	0.1258	0.0449	0.4089	0.15	2	0.0827
2000/1	11.313	16	0	16	0.0986	0.0352	0.3113	0.1699	0.2577	0.092	0.8135	0.29	2	0.1754
2000/2	11.232	17	0	17	0.0859	0.0307	0.2731	0.1489	0.2535	0.0905	0.806	0.29	2	0.174
2000/3	0.679	10	0	10	0.068	0.0243	3.5773	1.2783	0.6529	0.2332	34.3395	8.1	2	0.4604
2000/4	11.223	18	0	18	0.0709	0.0253	0.2257	0.123	0.2184	0.078	0.6951	0.25	2	0.1503
2000/5	7.439	19	1	18	0.063	0.0225	0.3023	0.1549	0.1522	0.0544	0.7307	0.25	2	0.1029
2000/6	11.181	19	0	19	0.0536	0.0191	0.171	0.0932	0.2783	0.0994	0.889	0.32	2	0.195
2000/7	10.858	16	0	16	0.0526	0.0188	0.1731	0.0939	0.1827	0.0653	0.6011	0.22	2	0.1265
2000/9	12.031	17	1	16	0.0602	0.0215	0.1787	0.0985	0.2447	0.0874	0.7263	0.26	2	0.1704
2000/10	11.374	18	0	18	0.0814	0.0291	0.2555	0.1395	0.2701	0.0965	0.8482	0.31	2	0.1866
2000/11	7.644	18	0	18	0.0827	0.0295	0.3863	0.1988	0.2289	0.0817	1.0694	0.36	2	0.1565
2000/12	11.314	19	1	18	0.0775	0.0277	0.2447	0.1336	0.2421	0.0864	0.7641	0.28	2	0.1667
2001/1	11.415	19	0	19	0.095	0.0339	0.2971	0.1623	0.241	0.0861	0.7539	0.27	2	0.1636
2001/2	11.347	19	0	19	0.0792	0.0283	0.2493	0.1361	0.1944	0.0694	0.6119	0.22	2	0.1316
2001/3	11.818	16	0	16	0.0659	0.0235	0.199	0.1093	0.2636	0.0941	0.7965	0.29	2	0.1834
2001/4	11.331	17	0	17	0.1067	0.0381	0.3364	0.1836	0.1895	0.0677	0.5971	0.22	2	0.1229
2001/5	8.063	19	1	18	0.0782	0.0279	0.3465	0.1797	0.1906	0.0681	0.8442	0.29	2	0.129

COMPENDIUM OF INTERNATIONAL ANALYSIS OF METHODS-OIV
Alcoholic strength by volume – Type I and IV methods

Table 16: Electronic densimetry (ED)

	MEAN no.1	n	outliers	n1	r	Sr	RSDr	Hor	R	sR	RSDR	HoR	no of replicates	difference
D1999/1	11.019	18	1	17	0.0677	0.0242	0.2196	0.1193	0.1996	0.0713	0.6470	0.23	2	0.1370
D1999/2	11.245	19	2	17	0.0448	0.0160	0.1423	0.0776	0.1311	0.0468	0.4165	0.15	2	0.0900
D1999/3	11.967	21	0	21	0.0701	0.0250	0.2091	0.1151	0.1552	0.0554	0.4631	0.17	2	0.1040
D1999/4	7.643	19	1	18	0.0610	0.0218	0.2852	0.1467	0.1340	0.0479	0.6262	0.21	2	0.0897
D1999/5	11.188	21	3	18	0.0260	0.0093	0.0829	0.0452	0.2047	0.0731	0.6536	0.24	2	0.1442
D1999/6	11.303	21	0	21	0.0652	0.0233	0.2061	0.1125	0.1466	0.0523	0.4631	0.17	2	0.0984
D1999/7	8.026	21	0	21	0.0884	0.0316	0.3935	0.2039	0.1708	0.0610	0.7600	0.26	2	0.1124
D1999/9	11.225	17	0	17	0.0372	0.0133	0.1183	0.0645	0.1686	0.0602	0.5366	0.19	2	0.1178
D1999/10	11.011	19	0	19	0.0915	0.0327	0.2969	0.1613	0.1723	0.0615	0.5588	0.20	2	0.1129
D1999/11	7.648	21	1	20	0.0615	0.0220	0.2872	0.1478	0.1538	0.0549	0.7183	0.24	2	0.1043
D1999/12	10.999	16	1	15	0.0428	0.0153	0.1389	0.0755	0.2015	0.0720	0.6541	0.23	2	0.1408
D2000/1	11.248	22	1	21	0.0697	0.0249	0.2212	0.1206	0.1422	0.0508	0.4516	0.16	2	0.0944
D2000/2	11.240	19	3	16	0.0448	0.0160	0.1424	0.0776	0.1619	0.0578	0.5145	0.19	2	0.1123
D2000/3	0.526	12	1	11	0.0327	0.0117	2.2185	0.7630	0.9344	0.3337	63.4009	14.39	2	0.6605
D2000/4	11.225	19	1	18	0.0476	0.0170	0.1514	0.0825	0.1350	0.0482	0.4295	0.15	2	0.0924
D2000/5	7.423	21	0	21	0.0628	0.0224	0.3019	0.1547	0.2635	0.0941	1.2677	0.43	2	0.1836
D2000/6	11.175	23	2	21	0.0606	0.0217	0.1938	0.1056	0.1697	0.0606	0.5424	0.20	2	0.1161
D2000/7	10.845	21	5	16	0.0440	0.0157	0.1449	0.0786	0.1447	0.0517	0.4766	0.17	2	0.0999
D2000/9	11.983	22	1	21	0.0841	0.0300	0.2507	0.1380	0.2410	0.0861	0.7183	0.26	2	0.1651
D2000/10	11.356	22	1	21	0.0635	0.0227	0.1997	0.1090	0.1865	0.0666	0.5866	0.21	2	0.1280
D2000/11	7.601	27	0	27	0.0521	0.0186	0.2448	0.1258	0.1685	0.0602	0.7916	0.27	2	0.1162
D2000/12	11.322	25	1	24	0.0476	0.0170	0.1503	0.0820	0.1594	0.0569	0.5028	0.18	2	0.1102
D2001/1	11.427	29	0	29	0.0706	0.0252	0.2207	0.1206	0.1526	0.0545	0.4771	0.17	2	0.1020
D2001/2	11.320	29	1	28	0.0675	0.0241	0.2128	0.1161	0.1570	0.0561	0.4952	0.18	2	0.1057
D2001/3	11.826	34	1	33	0.0489	0.0175	0.1476	0.0811	0.1762	0.0629	0.5322	0.19	2	0.1222
D2001/4	11.339	31	2	29	0.0639	0.0228	0.2012	0.1099	0.1520	0.0543	0.4788	0.17	2	0.1026
D2001/5	8.058	28	0	28	0.0473	0.0169	0.2098	0.1088	0.2025	0.0723	0.8976	0.31	2	0.1412

COMPENDIUM OF INTERNATIONAL ANALYSIS OF METHODS-OIV
Alcoholic strength by volume – Type I and IV methods

Table 17: Comparison of results from a hydrostatic balance (HB) and from electronic densimetry (ED)

	Mean (HB)	n	Values	n1		Mean (ED)	n	Values	n1	%ABV (HB-ED)
1999/1	11.043	17	1	16	D1999/1	11.019	18	1	17	0.024
1999/2	11.247	14	1	13	D1999/2	11.245	19	2	17	0.002
1999/3	11.946	16	0	16	D1999/3	11.967	21	0	21	-0.021
1999/4	7.653	17	1	16	D1999/4	7.643	19	1	18	0.010
1999/5	11.188	17	0	17	D1999/5	11.188	21	3	18	0.000
1999/6	11.276	19	0	19	D1999/6	11.303	21	0	21	-0.028
1999/7	8.018	17	0	17	D1999/7	8.026	21	0	21	-0.008
1999/9	11.226	17	0	17	D1999/9	11.225	17	0	17	0.002
1999/10	11.026	17	0	17	D1999/10	11.011	19	0	19	0.015
1999/11	7.701	16	1	15	D1999/11	7.648	21	1	20	0.052
1999/12	10.987	17	2	15	D1999/12	10.999	16	1	15	-0.013
2000/1	11.313	16	0	16	D2000/1	11.248	22	1	21	0.065
2000/2	11.232	17	0	17	D2000/2	11.240	19	3	16	-0.008
2000/3	0.679	10	0	10	D2000/3	0.526	12	1	11	0.153
2000/4	11.223	18	0	18	D2000/4	11.225	19	1	18	-0.002
2000/5	7.439	19	1	18	D2000/5	7.423	21	0	21	0.016
2000/6	11.181	19	0	19	D2000/6	11.175	23	2	21	0.006
2000/7	10.858	16	0	16	D2000/7	10.845	21	5	16	0.013
2000/9	12.031	17	1	16	D2000/9	11.983	22	1	21	0.049
2000/10	11.374	18	0	18	D2000/10	11.356	22	1	21	0.018
2000/11	7.644	18	0	18	D2000/11	7.601	27	0	27	0.043
2000/12	11.314	19	1	18	D2000/12	11.322	25	1	24	-0.008
2001/1	11.415	19	0	19	D2001/1	11.427	29	0	29	-0.012
2001/2	11.347	19	0	19	D2001/2	11.320	29	1	28	0.027
2001/3	11.818	16	0	16	D2001/3	11.826	34	1	33	-0.008
2001/4	11.331	17	0	17	D2001/4	11.339	31	2	29	-0.008
2001/5	8.063	19	1	18	D2001/5	8.058	28	0	28	0.004
Overall difference / %ABV (HB-ED)										0.014
Standard deviation/difference										0.036
* Test 2000/3 was not taken into account										

COMPENDIUM OF INTERNATIONAL ANALYSIS OF METHODS-OIV
Alcoholic strength by volume – Type I and IV methods

Table 18: Precision parameters

MEAN	Hydrostatic balance	Electronic densimetry
n1	441	557
relative repeatability variance	0.309	0.267
r	0.074	0.061
sr	0.026	0.022
relative reproducibility variance	2.948	2.150
R	0.229	0.174
sR	0.082	0.062

8. Bibliography

- Distillation:
 - HANAK, A., *Chem. Zgt.*, **56**, 1932, p. 984.
 - COLOMBIER, L., CLAIR, E., *Ann. Fals. Fraudes*, **29**, 1936, p. 411.
 - POZZI-ESCOT, E., *Ind. Agr. Aliment.*, **66**, 1949, p. 119.
 - JAULMES, P., *Analyse des vins*, 1951, p. 49.
 - SCHNEYDER, J., *Mitt. Klosterneuburg. Rebe und Wein.*, **10**, 1960, p. 228.
 - SCHNEYDER, J., KASCHNITZ, L., *Mitt. Klosterneuburg. Rebe und Wein.*, **15**, 1965, p. 132.

 - Pycnometry:
 - JAULMES, P., *Analyse des vins*, 1951, p. 67.
 - JAULMES, P., *Trav. Soc. Pharm. Montpellier.*, **12**, 1952, p. 154.
 - JAULMES, P., *Ann. Fals. Fraudes*, **46**, 1953, p. 84; **47**, 1954, p. 191.
 - JAULMES, P., CORDIER, Mlle S., *Trav. Soc. Pharm. Montpellier*, **16**, 1956, p. 115; **20**, 1960, p. 137.
 - JAULMES, P., BRUN, S., *Ann. Fals. Exp. Chim.*, **56**, 1963, p. 129.
- Hydrostatic balance:
- Cabanis, M. T., Cassanas, G., Raffy, J. and Cabanis, J. C., 'Validation de la mesure du titre alcoométrique volumique', *F.V. 1096*, 1999.
 - Cabanis, M. T., Cassanas, G., Raffy, J. and Cabanis, J. C., 'Intérêt de la balance hydrostatique "nouvelle génération" pour la détermination du titre alcoométrique des vins et des boissons spiritueuses', *Rev. Franç. Œnol.*, **177**, July-August, 1999, pp. 28-31.
 - Versini, G. and Larcher, R., 'Comparison of wine density and alcoholic strength measurement by hydrostatic balance and electronic density-meter', Communication by the OIV "Methods of Analysis" Sub-Commission, Paris, 13-15 March 2002.
- OIV Compendium of International Methods of Analysis of Wines and Musts*
E.g. Tables ??
International Office of Vine and Wine, Paris.

'International Harmonized Protocol for the Proficiency Testing of Analytical Chemical Laboratories', J. AOAC Intern., 74/4, 1993.

ISO 5725 standards and ISO 43 guides.

OIV Resolution OENO 6/1999.

Horwitz, W., 'Protocol for the design, conduct and interpretation of method-performance studies', *Pure and Applied Chemistry*, 67/2, 1995, pp. 331-343.

- Refractometry:

NEWTON, W., MURNO, F.L., *Can. Chem. Met.*, **17**, 1933, p. 119.

SAMPIETRO, C., INVERNIZZI, I., *Ann. Chem. Appl.*, **30**, 1940, p. 381.

FISCHL, P. F., *Food Manufacture*, **17**, 1942, p. 198.

JAULMES, P., LAVAL, J. P., *Trav. Soc. Pharm. Montpellier.*, **21**, 1961, p. 21.

JAULMES, P., BRUN, S., LAVAL, J. P., *Ann. Fals. Exp. Chim.*, **58**, 1965, p. 304; *Bull. Union National. OEnologues*, **13**, 1964, p. 17.

- Alcoholic strength tables:

TABLES ALCOOMETRIQUES FRANCAISES, *J.O. Républ. Française*, 30 Dec 1884, P. 6895.

OIML, International Organisation of Legal Metrology, 'International alcoholometric tables', R22, 1973.

WINDISCH, K., based on LUNGE, G., BERL, E., *Chem. techn. Untersuchungs Methoden*, Berlin, 1924, 7th ed.; **4**, 1893. p. 274.

OSBORNE, N. S., MCKELVY, E. C., BEARCE H. W., *Bull. Bur. of Standards*, Washington, **9**, 1913, p. 328.

FROST, A. V., 'Recherches dans le domaine du poids spécifique des mélanges d'alcool éthylique et d'eau', *Institute of Pure Chemical Reagents*. U.S.S.R., No. 9, 1930, based on SPAEPEN, J.

HEIDE, C von der, MANDLEN, H., *Z. Untersuch. Lebensm.*, **66**, 1933, p. 338.

KOYALOVICS, B., 8th General Conference on Weights and Measures, Moscow, 1933.

FERTMANN, G. I., 'Tables de renseignements pour le contrôle de la fabrication de l'alcool',

Pischerpoomizdat, Moscow, 1940.

REICHARD, O., *Neue Alkohol u. Extract. Tafel 20°/20°*, Verlag Hans Carl, Nürnberg, 1951.

JAULMES, P., MARIGNAN, R., *Ann. Fals. Fraudes.*, **46**, 1953, pp. 208 and 336.

SPAEPEN, J., *Rev. de Métrologie*, 1955, p. 411; *Bull. belge de Métrologie*, April No., 1955.

JAULMES, P., BRUN, S., *Ann. Fals. Exp. Chim.*, **46**, 1963, p. 143; **48**, 1965, p. 58; **49**, 1966, p. 35; **50**, 1967, pp. 101-147; *Trav. Soc. Pharm. Montpellier*, **26**, 1966, pp. 37 and 111.

JAULMES, P., MARIGNAN, R., *Bull. O.I.V.*, **274**, 1953, 28, 32.

JAULMES, P., BRUN, S., TEP, Y., *Trav. Soc. Pharm.*, **28**, 1968, p. 111.

KAWASAKI, T., MINOVA, Z., INAMATSU, T., 'A new alcohometric specific gravity table', *National Research of Metrology*, Tokyo, 1967.

TEP, Y., 'Étude d'une table alcoométrique internationale', *Thèse Doc. Pharm.*, Montpellier, 1968.

TABLE I (continued) International alcoholic strength at 20°C

2 **Table of apparent densities of ethanol-water mixtures - Pyrex pycnometer** Densities at t°C. corrected for air buoyancy

t°	Alcohol % by volume																							
	0	1	2	3	4	5	6	7	8	9	10	11	12	13	14	15	16	17	18	19	20	21		
20°	998.20	1.50	996.70	1.46	995.24	1.43	993.81	1.39	992.42	1.36	991.06	1.33	989.73	1.29	988.44	1.27	987.17	1.24	985.93	1.22	984.71	1.19	983.52	1.16
21°	998.00	1.50	996.50	1.46	995.04	1.43	993.61	1.40	992.21	1.36	990.85	1.33	989.52	1.30	988.22	1.27	986.95	1.25	985.70	1.23	984.47	1.19	983.28	1.18
22°	997.79	1.50	996.29	1.46	994.83	1.43	993.40	1.40	992.00	1.37	990.63	1.33	989.30	1.31	987.99	1.28	986.71	1.25	985.46	1.23	984.23	1.21	983.02	1.18
23°	997.57	1.50	996.07	1.47	994.60	1.43	993.17	1.40	991.77	1.37	990.40	1.34	989.06	1.31	987.75	1.28	986.47	1.26	985.21	1.24	983.97	1.20	982.77	1.20
24°	997.33	1.49	995.94	1.47	994.37	1.43	992.94	1.41	991.53	1.37	990.16	1.34	988.82	1.32	987.50	1.29	986.21	1.26	984.95	1.25	983.70	1.22	982.48	1.20
25°	997.09	1.50	995.59	1.46	994.13	1.44	992.69	1.40	991.29	1.38	989.91	1.35	988.56	1.32	987.24	1.29	985.95	1.27	984.68	1.26	983.42	1.22	982.20	1.21
26°	996.84	1.50	995.34	1.47	993.87	1.43	992.44	1.41	991.03	1.38	989.65	1.35	988.30	1.32	986.98	1.31	985.67	1.27	984.40	1.26	983.14	1.24	981.90	1.22
27°	996.58	1.50	995.68	1.47	993.61	1.44	992.17	1.41	990.76	1.38	989.38	1.35	988.03	1.33	986.70	1.31	985.39	1.28	984.11	1.27	982.84	1.24	981.60	1.23
28°	996.31	1.50	994.81	1.47	993.34	1.44	991.90	1.42	990.48	1.38	989.10	1.36	987.74	1.33	986.41	1.31	985.10	1.29	983.81	1.28	982.53	1.25	981.28	1.23
29°	996.03	1.50	994.53	1.47	993.06	1.45	991.61	1.41	990.20	1.39	988.81	1.36	987.45	1.34	986.11	1.32	984.79	1.29	983.50	1.28	982.22	1.26	980.96	1.24
30°	995.75	1.51	994.24	1.47	992.77	1.45	991.32	1.42	989.90	1.39	988.51	1.37	987.14	1.34	985.80	1.32	984.48	1.30	983.18	1.28	981.90	1.27	980.63	1.25
31°	995.45	1.51	993.94	1.47	992.47	1.45	991.02	1.43	989.59	1.39	988.20	1.37	986.83	1.34	985.49	1.33	984.16	1.31	982.85	1.29	981.56	1.27	980.29	1.26
30°	995.14	1.51	993.63	1.47	992.16	1.46	990.70	1.42	989.28	1.40	987.88	1.37	986.51	1.35	985.16	1.33	983.83	1.32	982.51	1.30	981.21	1.28	979.93	1.26
33°	994.93	1.51	993.32	1.48	991.84	1.46	990.38	1.42	988.96	1.41	987.55	1.37	986.18	1.36	984.82	1.34	983.48	1.32	982.16	1.30	980.86	1.28	979.58	1.28
34°	994.51	1.52	992.99	1.48	991.51	1.46	990.05	1.44	988.61	1.40	987.21	1.38	985.83	1.36	984.47	1.33	983.14	1.33	981.81	1.31	980.50	1.29	979.21	1.28
35°	994.18	1.52	992.66	1.49	991.17	1.47	989.70	1.43	988.27	1.41	986.86	1.38	985.48	1.36	984.12	1.34	982.78	1.33	981.45	1.31	980.14	1.30	978.84	1.29
36°	993.84	1.53	992.31	1.49	990.82	1.47	989.35	1.43	987.92	1.41	986.51	1.38	985.13	1.37	983.76	1.34	982.42	1.34	981.08	1.31	979.77	1.31	978.46	1.29
37°	993.49	1.53	991.96	1.50	990.46	1.46	989.00	1.44	987.56	1.41	986.15	1.39	984.76	1.37	983.39	1.35	982.04	1.33	980.71	1.33	979.38	1.31	978.07	1.30
38°	993.13	1.53	991.60	1.50	990.10	1.47	988.63	1.44	987.19	1.41	985.78	1.39	984.39	1.37	983.02	1.36	981.66	1.34	980.32	1.32	979.00	1.32	977.68	1.31
39°	992.77	1.54	991.23	1.50	989.73	1.47	988.26	1.45	986.81	1.41	985.40	1.39	994.01	1.38	982.63	1.35	981.28	1.35	979.93	1.33	978.60	1.32	977.28	1.32

OIV-MA-AS312-02: R2009

40°	992.40	1.54	990.86	1.51	989.35	1.48	987.87	1.44	986.43	1.42	985.01	1.39	983.62	1.38	982.24	1.36	980.88	1.34	979.54	1.34	978.20	1.33	976.87	1.32
-----	--------	------	--------	------	--------	------	--------	------	--------	------	--------	------	--------	------	--------	------	--------	------	--------	------	--------	------	--------	------

TABLE I (continued) International alcoholic strength at 20°C

3 OIV-MA-AS312-02: R2009 Table of apparent densities of ethanol-water mixtures - Pyrex pycnometer Densities at t°C. corrected for air buoyancy

t°	Alcohol % by volume																							
	10	11	12	13	14	15	16	17	18	19	20	21	10	11	12	13	14	15	16	17	18	19	20	21
0	986.93	1.00	985.93	0.95	984.98	0.92	984.0	0.88	983.1	0.84	982.34	0.80	981.54	0.78	980.76	0.75	980.01	0.73	979.28	0.72	978.56	0.70	977.86	0.70
1	-0.02		-0.01		0.01		0.01		0.03		0.04		0.07		0.08		0.10		0.12		0.14		0.17	
2	986.95	1.01	995.94	0.97	984.97	0.92	984.0	0.90	983.1	0.85	982.30	0.83	981.47	0.79	980.68	0.77	979.91	0.75	979.16	0.74	978.42	0.73	977.69	0.72
3	-0.01		0.00		0.01		0.03		0.04		0.07		0.08		0.10		0.12		0.14		0.16		0.18	
4	986.96	1.02	985.94	0.98	984.96	0.94	984.0	0.91	983.1	0.98	982.23	0.84	981.39	0.81	980.58	0.79	979.79	0.77	979.02	0.76	978.26	0.75	977.51	0.74
5	0.01		0.02		0.04		0.05		0.06		0.07		0.09		0.11		0.13		0.15		0.17		0.19	
6	986.95	1.03	985.92	1.00	984.92	0.95	983.9	0.92	983.0	0.89	982.16	0.86	981.30	0.83	980.47	0.81	979.66	0.79	978.87	0.78	978.09	0.77	977.32	0.77
7	0.03		0.04		0.04		0.06		0.07		0.09		0.10		0.12		0.14		0.16		0.18		0.20	
8	986.92	1.04	985.88	1.00	984.88	0.97	983.9	0.93	982.9	0.91	982.07	0.87	981.20	0.85	980.35	0.83	979.52	0.81	978.71	0.80	977.91	0.79	977.12	0.79
9	0.04		0.05		0.06		0.07		0.09		0.10		0.12		0.14		0.15		0.17		0.19		0.22	
10	986.88	1.05	985.83	1.01	984.82	0.98	983.8	0.95	982.8	0.92	981.97	0.89	981.08	0.87	980.21	0.84	979.37	0.83	978.54	0.82	977.72	0.82	976.90	0.80
11	0.05		0.06		0.08		0.09		0.10		0.12		0.13		0.14		0.17		0.19		0.21		0.22	
12	986.93	1.06	985.77	1.03	984.74	0.99	983.7	0.96	982.7	0.94	981.85	0.90	980.95	0.88	980.07	0.87	979.20	0.85	978.35	0.84	977.51	0.83	976.68	0.83
13	0.08		0.09		0.09		0.10		0.12		0.13		0.15		0.16		0.18		0.19		0.21		0.23	
14	986.75	1.07	995.68	1.03	984.65	1.00	983.6	0.98	982.6	0.95	981.72	0.92	980.80	0.89	979.91	0.89	979.02	0.86	978.16	0.86	977.30	0.85	976.45	0.85
15	0.08		0.09		0.11		0.13		0.13		0.14		0.15		0.18		0.19		0.21		0.23		0.25	
16	986.67	1.08	985.59	1.05	984.54	1.02	983.5	0.98	982.5	0.96	981.58	0.93	980.65	0.92	979.73	0.90	978.83	0.88	977.95	0.88	977.07	0.87	976.20	0.87
17	0.10		0.11		0.12		0.12		0.14		0.16		0.18		0.19		0.21		0.22		0.24		0.26	
18	986.57	1.09	985.48	1.06	984.42	1.02	983.4	1.00	982.4	0.98	981.42	0.95	980.47	0.93	979.54	0.92	978.62	0.89	977.73	0.90	976.83	0.89	975.94	0.89
19	0.11		0.12		0.12		0.14		0.16		0.17		0.18		0.20		0.20		0.23		0.24		0.26	
20	986.46	1.10	985.36	1.06	984.30	1.04	983.2	1.02	982.2	0.99	981.25	0.96	980.29	0.95	979.34	0.92	978.42	0.92	977.50	0.91	976.59	0.91	975.68	0.91
21	0.12		0.13		0.14		0.16		0.16		0.17		0.19		0.20		0.23		0.25		0.27		0.29	
22	986.34	1.11	985.23	1.07	984.16	1.06	983.1	1.02	982.0	1.00	981.08	0.98	980.10	0.96	979.14	0.95	978.19	0.94	977.25	0.93	976.32	0.93	975.39	0.92
23	0.13		0.14		0.16		0.16		0.18		0.19		0.21		0.22		0.24		0.25		0.27		0.28	
24	986.21	1.12	985.09	1.09	984.00	1.06	982.9	1.04	981.9	1.01	980.89	1.00	979.89	0.97	978.92	0.97	977.95	0.95	977.00	0.95	976.05	0.94	975.11	0.95
25	0.15		0.16		0.16		0.18		0.19		0.20		0.21		0.23		0.24		0.26		0.28		0.30	
26	986.06	1.13	984.93	1.09	983.84	1.08	982.7	1.05	981.7	1.02	980.69	1.01	979.68	0.99	978.69	0.98	977.71	0.97	976.74	0.97	975.77	0.96	974.81	0.96
27	0.16		0.16		0.18		0.18		0.20		0.22		0.23		0.24		0.26		0.27		0.28		0.30	
28	985.90	1.13	994.77	1.11	983.66	1.08	982.5	1.07	981.5	1.04	980.47	1.02	979.45	1.00	978.45	1.00	977.45	0.98	976.47	0.98	975.49	0.98	974.51	0.98
29	0.17		0.18		0.19		0.20		0.21		0.22		0.24		0.25		0.26		0.28		0.30		0.32	
30	985.73	1.14	994.59	1.12	983.47	1.09	982.3	1.08	981.3	1.05	960.25	1.04	979.21	1.01	978.20	1.01	977.19	1.00	976.19	1.00	975.19	1.00	974.19	1.00
31	0.18		0.19		0.20		0.22		0.22		0.24		0.24		0.27		0.28		0.30		0.31		0.32	
32	985.55	1.15	984.40	1.13	983.27	1.11	982.1	1.08	981.0	1.07	980.01	1.04	978.97	1.04	977.93	1.02	976.91	1.02	975.89	1.01	974.88	1.01	973.87	1.02
33	0.19		0.20		0.21		0.22		0.23		0.24		0.26		0.27		0.29		0.30		0.32		0.33	
34	985.13	1.16	984.20	1.14	983.06	1.12	981.9	1.09	980.8	1.08	979.77	1.06	978.71	1.05	977.66	1.04	976.62	1.03	975.59	1.03	974.56	1.02	973.54	1.04
35	0.21		0.22		0.22		0.23		0.25		0.26		0.27		0.28		0.29		0.31		0.32		0.35	
36	985.15	1.17	983.76	1.14	982.84	1.13	981.7	1.11	980.6	1.09	979.51	1.07	978.44	1.06	977.38	1.05	976.33	1.05	975.28	1.04	974.24	1.05	973.19	1.05
37	0.21		0.22		0.24		0.24		0.25		0.26		0.28		0.29		0.31		0.32		0.34		0.35	

19	984.94 0.23	1.18	983.76 0.24	1.16	982.60 0.24	1.13	981.4 0.26	1.12	980.3 0.27	1.10	979.25 0.28	1.09	978.16 0.29	1.07	977.09 0.30	1.07	976.02 0.31	1.06	974.96 0.33	1.06	973.90 0.34	1.06	972.84 0.36	1.06
20	984.71	1.19	983.52	1.16	982.36	1.15	981.2	1.13	980.0	1.11	978.97	1.10	977.87	1.08	976.7	1.08	975.7	1.08	974.63	1.07	973.56	1.08	972.48	1.08

TABLE I (continued) International alcoholic strength at 20°C
Table of apparent densities of ethanol-water mixtures - Pyrex pycnometer Densities at t°C. corrected for air buoyancy

4
OIV-MA-AS312-02: R2009

t°	Alcohol % by volume																							
	10	11	12	13	14	15	16	17	18	19	20	21	10	11	12	13	14	15	16	17	18	19	20	21
20°	984.71	1.19	983.52	1.16	982.36	1.15	981.21	1.13	980.08	1.11	978.97	1.10	977.87	1.08	976.79	1.08	975.71	1.08	974.63	1.07	973.56	1.08	972.48	1.08
	0.24		0.24		0.26		0.26		0.27		0.28		0.29		0.31		0.33		0.34		0.36		0.37	
21°	994.47	1.19	983.28	1.18	982.10	1.15	980.95	1.14	978.81	1.12	978.69	1.11	977.58	1.10	976.48	1.10	975.38	1.09	974.29	1.09	973.20	1.09	972.11	1.09
	0.24		0.26		0.28		0.29		0.30		0.31		0.33		0.33		0.35		0.35		0.36		0.37	
22°	984.23	1.21	983.02	1.18	981.84	1.17	980.67	1.15	979.52	1.13	978.39	1.12	977.27	1.12	976.15	1.10	975.05	1.11	973.94	1.10	972.84	1.10	971.74	1.12
	0.26		0.26		0.27		0.28		0.29		0.31		0.32		0.33		0.35		0.35		0.37		0.39	
23°	983.97	1.20	982.77	1.20	981.57	1.18	980.39	1.16	979.23	1.15	978.08	1.13	976.95	1.13	975.82	1.12	974.70	1.11	973.59	1.12	972.47	1.12	971.47	1.12
	0.27		0.29		0.29		0.29		0.30		0.31		0.33		0.33		0.35		0.37		0.38		0.40	
24°	983.70	1.22	982.48	1.20	981.28	1.18	980.10	1.17	978.93	1.16	977.77	1.15	976.62	1.13	975.49	1.14	974.35	1.13	973.22	1.13	972.09	1.14	970.95	1.14
	0.28		0.28		0.29		0.31		0.32		0.33		0.33		0.35		0.36		0.37		0.39		0.40	
25°	983.42	1.22	982.20	1.21	980.99	1.20	979.79	1.18	978.61	1.17	977.44	1.15	976.29	1.15	975.14	1.15	973.99	1.14	972.85	1.15	971.70	1.15	970.55	1.16
	0.28		0.30		0.31		0.31		0.32		0.33		0.35		0.36		0.37		0.39		0.40		0.41	
26°	983.14	1.24	981.90	1.22	980.68	1.20	979.48	1.19	978.29	1.18	977.11	1.17	975.94	1.16	974.78	1.16	973.62	1.16	972.46	1.16	971.30	1.16	970.14	1.17
	0.30		0.30		0.31		0.32		0.33		0.34		0.35		0.36		0.38		0.39		0.40		0.42	
27°	982.84	1.24	981.60	1.23	980.37	1.21	979.16	1.20	977.96	1.19	976.77	1.18	975.59	1.17	974.42	1.18	973.24	1.17	972.07	1.17	970.90	1.18	969.72	1.18
	0.31		0.32		0.32		0.33		0.34		0.35		0.36		0.38		0.38		0.40		0.41		0.43	
28°	982.53	1.25	981.28	1.23	980.05	1.22	978.83	1.21	977.62	1.20	976.42	1.19	975.23	1.19	974.04	1.18	972.86	1.19	971.67	1.18	970.49	1.20	969.29	1.20
	0.31		0.32		0.33		0.34		0.35		0.36		0.37		0.38		0.40		0.40		0.42		0.43	
29°	982.22	1.26	980.96	1.24	979.72	1.23	978.49	1.22	977.27	1.21	976.06	1.20	974.86	1.20	973.66	1.20	972.46	1.19	971.27	1.20	970.07	1.21	968.86	1.22
	0.32		0.33		0.34		0.35		0.36		0.37		0.38		0.40		0.41		0.43		0.44		0.45	
30°	981.90	1.27	980.63	1.25	979.38	1.24	978.14	1.23	976.91	1.22	975.69	1.21	974.48	1.22	973.26	1.21	972.05	1.21	970.84	1.21	969.63	1.22	968.41	1.23
	0.34		0.34		0.35		0.36		0.37		0.38		0.40		0.40		0.41		0.42		0.44		0.45	
31°	981.56	1.27	980.29	1.26	979.03	1.25	977.78	1.24	976.54	1.23	975.31	1.23	974.08	1.22	972.86	1.22	971.64	1.22	970.42	1.23	969.19	1.23	967.96	1.24
	0.35		0.36		0.36		0.37		0.38		0.39		0.39		0.40		0.42		0.43		0.44		0.46	
32°	981.21	1.28	979.93	1.26	978.67	1.26	977.41	1.25	976.16	1.24	974.92	1.23	973.69	1.23	972.46	1.24	971.22	1.23	969.99	1.24	968.75	1.25	967.50	1.25
	0.35		0.35		0.37		0.37		0.38		0.39		0.40		0.42		0.42		0.44		0.45		0.46	
33°	980.86	1.28	979.58	1.28	978.30	1.26	977.04	1.26	975.78	1.25	974.53	1.24	973.29	1.25	972.04	1.24	970.80	1.25	969.55	1.25	968.30	1.26	967.04	1.27
	0.36		0.37		0.37		0.38		0.39		0.40		0.41		0.42		0.43		0.44		0.46		0.47	
34°	980.50	1.29	979.21	1.28	977.93	1.27	976.66	1.27	975.39	1.26	974.13	1.25	972.88	1.26	971.62	1.25	970.37	1.26	969.11	1.27	967.84	1.27	966.57	1.29
	0.36		0.37		0.38		0.39		0.39		0.40		0.42		0.42		0.44		0.46		0.46		0.48	
35°	980.14	1.30	978.94	1.29	977.55	1.28	976.27	1.27	975.00	1.27	973.73	1.27	972.46	1.26	971.20	1.27	969.93	1.28	968.65	1.27	967.38	1.29	966.09	1.30
	0.37		0.38		0.38		0.39		0.40		0.41		0.42		0.44		0.45		0.45		0.47		0.48	
36°	979.77	1.31	978.46	1.29	977.17	1.29	975.88	1.28	974.60	1.28	973.32	1.28	972.04	1.28	970.76	1.28	969.48	1.28	968.20	1.29	966.91	1.30	965.61	1.32
	0.39		0.39		0.40		0.40		0.41		0.42		0.43		0.44		0.45		0.47		0.48		0.49	
37°	978.38	1.31	978.07	1.30	976.77	1.29	975.48	1.29	974.19	1.29	972.90	1.29	971.61	1.29	970.32	1.29	969.03	1.30	967.73	1.30	966.43	1.31	965.12	1.33

COMPENDIUM OF INTERNATIONAL ANALYSIS OF METHODS-OIV
Alcoholic strength by volume

38°	0.38		0.39		0.40		0.41		0.42		0.43		0.44		0.45		0.46		0.47		0.49		0.50	
	979.00	1.32	977.68	1.31	976.37	1.30	975.07	1.30	973.77	1.30	972.47	1.30	971.17	1.30	969.87	1.30	968.57	1.31	967.26	1.32	965.94	1.32	964.62	1.34
39°	0.40		0.40		0.41		0.42		0.42		0.43		0.44		0.45		0.47		0.48		0.49		0.50	
	978.60	1.32	977.28	1.32	975.96	1.31	974.65	1.30	973.35	1.31	972.04	1.31	970.73	1.31	969.42	1.32	968.10	1.32	966.78	1.33	965.45	1.33	964.12	1.36
	0.40		0.41		0.41		0.42		0.43		0.44		0.45		0.46		0.47		0.48		0.49		0.51	
40°	978.20	1.33	976.87	1.32	975.55	1.32	974.23	1.31	972.92	1.32	971.60	1.52	970.28	1.32	968.96	1.33	967.63	1.33	966.30	1.34	964.96	1.35	963.61	1.37

TABLE I (continued) International alcoholic strength at 20°C

Table of apparent densities of ethanol-water mixtures - **Pyrex pycnometer** Densities at *t*°C. corrected for air buoyancy

<i>t</i> °	Alcohol % by volume																							
	20	21	22	23	24	25	26	27	28	29	30	31	20	21	22	23	24	25	26	27	28	29	30	31
20	0.36	0.37	0.38	0.40	0.42	0.44	0.45	0.46	0.49	0.50	0.51	0.52	0.52	0.52	0.52	0.52	0.52	0.52	0.52	0.52	0.52	0.52	0.52	0.52
21	0.36	0.37	0.40	0.41	0.42	0.44	0.45	0.48	0.49	0.51	0.52	0.52	0.52	0.52	0.52	0.52	0.52	0.52	0.52	0.52	0.52	0.52	0.52	0.52
22	0.37	0.39	0.40	0.42	0.43	0.45	0.47	0.48	0.49	0.51	0.52	0.52	0.52	0.52	0.52	0.52	0.52	0.52	0.52	0.52	0.52	0.52	0.52	0.52
23	0.38	0.40	0.41	0.42	0.44	0.45	0.47	0.49	0.51	0.52	0.52	0.52	0.52	0.52	0.52	0.52	0.52	0.52	0.52	0.52	0.52	0.52	0.52	0.52
24	0.39	0.40	0.42	0.43	0.45	0.47	0.48	0.49	0.51	0.52	0.52	0.52	0.52	0.52	0.52	0.52	0.52	0.52	0.52	0.52	0.52	0.52	0.52	0.52
25	0.40	0.41	0.42	0.44	0.46	0.47	0.49	0.50	0.51	0.52	0.52	0.52	0.52	0.52	0.52	0.52	0.52	0.52	0.52	0.52	0.52	0.52	0.52	0.52
26	0.40	0.42	0.43	0.45	0.46	0.48	0.49	0.51	0.52	0.52	0.52	0.52	0.52	0.52	0.52	0.52	0.52	0.52	0.52	0.52	0.52	0.52	0.52	0.52
27	0.41	0.43	0.45	0.46	0.47	0.48	0.50	0.51	0.52	0.52	0.52	0.52	0.52	0.52	0.52	0.52	0.52	0.52	0.52	0.52	0.52	0.52	0.52	0.52
28	0.42	0.43	0.45	0.47	0.49	0.50	0.52	0.53	0.53	0.53	0.53	0.53	0.53	0.53	0.53	0.53	0.53	0.53	0.53	0.53	0.53	0.53	0.53	0.53
29	0.44	0.45	0.46	0.47	0.49	0.50	0.51	0.52	0.53	0.53	0.53	0.53	0.53	0.53	0.53	0.53	0.53	0.53	0.53	0.53	0.53	0.53	0.53	0.53
30	0.44	0.45	0.46	0.48	0.49	0.51	0.52	0.53	0.55	0.55	0.55	0.55	0.55	0.55	0.55	0.55	0.55	0.55	0.55	0.55	0.55	0.55	0.55	0.55
31	0.44	0.46	0.47	0.48	0.50	0.51	0.53	0.54	0.55	0.56	0.56	0.56	0.56	0.56	0.56	0.56	0.56	0.56	0.56	0.56	0.56	0.56	0.56	0.56
32	0.45	0.46	0.48	0.49	0.50	0.52	0.53	0.54	0.55	0.56	0.57	0.57	0.57	0.57	0.57	0.57	0.57	0.57	0.57	0.57	0.57	0.57	0.57	0.57
33	0.46	0.47	0.49	0.50	0.51	0.53	0.54	0.55	0.56	0.57	0.58	0.58	0.58	0.58	0.58	0.58	0.58	0.58	0.58	0.58	0.58	0.58	0.58	0.58
34	0.46	0.48	0.49	0.51	0.52	0.53	0.55	0.56	0.57	0.58	0.59	0.59	0.59	0.59	0.59	0.59	0.59	0.59	0.59	0.59	0.59	0.59	0.59	0.59
35	0.47	0.48	0.50	0.51	0.53	0.54	0.55	0.57	0.58	0.59	0.60	0.60	0.60	0.60	0.60	0.60	0.60	0.60	0.60	0.60	0.60	0.60	0.60	0.60
36	0.48	0.49	0.50	0.52	0.53	0.55	0.56	0.57	0.58	0.59	0.60	0.60	0.60	0.60	0.60	0.60	0.60	0.60	0.60	0.60	0.60	0.60	0.60	0.60
37	0.49	0.50	0.51	0.52	0.54	0.55	0.57	0.58	0.59	0.60	0.61	0.61	0.61	0.61	0.61	0.61	0.61	0.61	0.61	0.61	0.61	0.61	0.61	0.61
38	0.49	0.50	0.52	0.53	0.54	0.56	0.57	0.58	0.59	0.60	0.61	0.61	0.61	0.61	0.61	0.61	0.61	0.61	0.61	0.61	0.61	0.61	0.61	0.61
39	0.49	0.51	0.52	0.54	0.55	0.56	0.58	0.59	0.60	0.61	0.62	0.62	0.62	0.62	0.62	0.62	0.62	0.62	0.62	0.62	0.62	0.62	0.62	0.62
40	0.49	0.51	0.52	0.54	0.55	0.56	0.58	0.59	0.60	0.61	0.62	0.62	0.62	0.62	0.62	0.62	0.62	0.62	0.62	0.62	0.62	0.62	0.62	0.62

OIV-MA-AS312-02: R2009
6

TABLE II International alcoholic strength at 20°C
 Table of Corrections to be applied to the apparent alcoholic strength to correct for the effect of temperature
 Add or subtract from the apparent alcoholic strength at $t^{\circ}\text{C}$ (ordinary glass alcohol meter) the correction indicated
 below

		Apparent alcoholic strength at $t^{\circ}\text{C}$																
		0	1	2	3	4	5	6	7	8	9	10	11	12	13	14	15	16
Temperatures	0	0.76	0.77	0.82	0.87	0.95	1.04	1.16	1.31	1.49	1.70	1.95	2.26	2.62	3.03	3.49	4.02	4.56
	1°	0.81	0.83	0.87	0.92	1.00	1.09	1.20	1.35	1.52	1.73	1.97	2.26	2.59	2.97	3.40	3.87	4.36
	2°	0.85	0.87	0.92	0.97	1.04	1.13	1.24	1.38	1.54	1.74	1.97	2.24	2.54	2.89	3.29	3.72	4.17
	3°	0.88	0.91	0.95	1.00	1.07	1.15	1.26	1.39	1.55	1.73	1.95	2.20	2.48	2.80	3.16	3.55	3.95
	4°	0.90	0.92	0.97	1.02	1.09	1.17	1.27	1.40	1.55	1.72	1.92	2.15	2.41	2.71	3.03	3.38	3.75
	5°	0.91	0.93	0.98	1.03	1.10	1.17	1.27	1.39	1.53	1.69	1.87	2.08	2.33	2.60	2.89	3.21	3.54
	6°	0.92	0.94	0.98	1.02	1.09	1.16	1.25	1.37	1.50	1.65	1.82	2.01	2.23	2.47	2.74	3.02	3.32
	7°	0.91	0.93	0.97	1.01	1.07	1.14	1.23	1.33	1.45	1.59	1.75	1.92	2.12	2.34	2.58	2.83	3.10
	8°	0.89	0.91	0.94	0.98	1.04	1.11	1.19	1.28	1.39	1.52	1.66	1.82	2.00	2.20	2.42	2.65	2.88
	9°	0.86	0.88	0.91	0.95	1.01	1.07	1.14	1.23	1.33	1.44	1.57	1.71	1.97	2.05	2.24	2.44	2.65
	10°	0.82	0.84	0.87	0.91	0.96	1.01	1.08	1.16	1.25	1.35	1.47	1.60	1.74	1.89	2.06	2.24	2.43
	11°	0.78	0.79	0.82	0.86	0.90	0.95	1.01	1.08	1.16	1.25	1.36	1.47	1.60	1.73	1.88	2.03	2.20
	12°	0.72	0.74	0.76	0.79	0.83	0.88	0.93	0.99	1.07	1.15	1.24	1.34	1.44	1.56	1.69	1.82	1.96
	13°	0.66	0.67	0.69	0.72	0.76	0.80	0.84	0.90	0.96	1.03	1.11	1.19	1.28	1.38	1.49	1.61	1.73
	14°	0.59	0.60	0.62	0.64	0.67	0.71	0.74	0.79	0.85	0.91	0.97	1.04	1.12	1.20	1.29	1.39	1.49
	15°	0.51	0.52	0.53	0.55	0.58	0.61	0.64	0.68	0.73	0.77	0.83	0.89	0.95	1.02	1.09	1.16	1.24
	16°	0.42	0.43	0.44	0.46	0.48	0.50	0.53	0.56	0.60	0.63	0.67	0.72	0.77	0.82	0.88	0.94	1.00
	17°	0.33	0.33	0.34	0.35	0.37	0.39	0.41	0.43	0.46	0.48	0.51	0.55	0.59	0.62	0.67	0.71	0.75
	18°	0.23	0.23	0.23	0.24	0.25	0.26	0.27	0.29	0.31	0.33	0.35	0.37	0.40	0.42	0.45	0.48	0.51

19°	0.12	0.12	0.12	0.12	0.13	0.13	0.14	0.15	0.16	0.17	0.18	0.19	0.20	0.21	0.23	0.24	0.25
-----	------	------	------	------	------	------	------	------	------	------	------	------	------	------	------	------	------

TABLE II (continued)
International alcoholic strength at 20°C
Table of Corrections to be applied to the apparent alcoholic strength to correct for the effect of temperature
Add or subtract from the apparent alcoholic strength at *t*°C (ordinary glass alcohol meter) the correction indicated
below

		Apparent alcoholic strength at <i>t</i> °C																		
		0	1	2	3	4	5	6	7	8	9	10	11	12	13	14	15	16		
Temperatures	To subtract	21°		0.13	0.13	0.13	0.14	0.14	0.15	0.16	0.17	0.18	0.19	0.19	0.20	0.22	0.23	0.25	0.26	
		22°		0.26	0.27	0.28	0.29	0.30	0.31	0.32	0.34	0.36	0.37	0.39	0.41	0.44	0.47	0.49	0.52	
		23°		0.40	0.41	0.42	0.44	0.45	0.47	0.49	0.51	0.54	0.57	0.60	0.63	0.66	0.70	0.74	0.78	
		24°		0.55	0.56	0.58	0.60	0.62	0.64	0.67	0.70	0.73	0.77	0.81	0.85	0.89	0.94	0.99	1.04	
		25°		0.69	0.71	0.73	0.76	0.79	0.82	0.85	0.89	0.93	0.97	1.02	1.07	1.13	1.19	1.25	1.31	
		26°		0.85	0.87	0.90	0.93	0.96	1.00	1.04	1.08	1.13	1.18	1.24	1.30	1.36	1.43	1.50	1.57	
		27°			1.03	1.07	1.11	1.15	1.19	1.23	1.28	1.34	1.40	1.46	1.53	1.60	1.68	1.76	1.84	
		28°			1.21	1.25	1.29	1.33	1.38	1.43	1.49	1.55	1.62	1.69	1.77	1.85	1.93	2.02	2.11	
		29°			1.39	1.43	1.47	1.52	1.58	1.63	1.70	1.76	1.84	1.92	2.01	2.10	2.19	2.29	2.39	
		30°				1.57	1.61	1.66	1.72	1.78	1.84	1.91	1.98	2.07	2.15	2.25	2.35	2.45	2.56	2.67
		31°				1.75	1.80	1.86	1.92	1.98	2.05	2.13	2.21	2.30	2.39	2.49	2.60	2.71	2.83	2.94
		32°				1.94	2.00	2.06	2.13	2.20	2.27	2.35	2.44	2.53	2.63	2.74	2.86	2.97	3.09	3.22
		33°					2.20	2.27	2.34	2.42	2.50	2.58	2.67	2.77	2.88	2.99	3.12	3.24	3.37	3.51
		34°					2.41	2.48	2.56	2.64	2.72	2.81	2.91	3.02	3.13	3.25	3.38	3.51	3.65	3.79
		35°					2.62	2.70	2.78	2.86	2.95	3.05	3.16	3.27	3.39	3.51	3.64	3.78	3.93	4.08

36°				2.83	2.91	3.00	3.09	3.19	3.29	3.41	3.53	3.65	3.78	3.91	4.05	4.21	4.37
37°					3.13	3.23	3.33	3.43	3.54	3.65	3.78	3.91	4.04	4.18	4.33	4.49	4.65
38°					3.36	3.47	3.57	3.68	3.79	3.91	4.03	4.17	4.31	4.46	4.61	4.77	4.94
39°					3.59	3.70	3.81	3.93	4.05	4.17	4.44	4.58	4.74	4.90	5.06	5.06	5.23
40°					3.82	3.94	4.06	4.18	4.31	4.44	4.57	4.71	4.86	5.02	5.19	5.36	5.53

TABLE II (continued)
International alcoholic strength at 20°C

Table of Corrections to be applied to the apparent alcoholic strength to correct for the effect of temperature
Add or subtract from the apparent alcoholic strength at t°C (ordinary glass alcohol meter) the correction indicated below

		Apparent alcoholic strength at t°C																	
		14	15	16	17	18	19	20	21	22	23	24	25	26	27	28	29	30	
Temperatures	To add	0°	3.49	4.02	4.56	5.11	5.65	6.16	6.63	7.05	7.39	7.67	7.91	8.07	8.20	8.30	8.36	8.39	8.40
	1°	3.40	3.87	4.36	4.86	5.35	5.82	6.26	6.64	6.96	7.23	7.45	7.62	7.75	7.85	7.91	7.95	7.96	
	2°	3.29	3.72	4.17	4.61	5.05	5.49	5.89	6.25	6.55	6.81	7.02	7.18	7.31	7.40	7.47	7.51	7.53	
	3°	3.16	3.55	3.95	4.36	4.77	5.17	5.53	5.85	6.14	6.39	6.59	6.74	6.86	6.97	7.03	7.07	7.09	
	4°	3.03	3.38	3.75	4.11	4.48	4.84	5.17	5.48	5.74	5.97	6.16	6.31	6.43	6.53	6.59	6.63	6.66	
	5°	2.89	3.21	3.54	3.86	4.20	4.52	4.83	5.11	5.35	5.56	5.74	5.89	6.00	6.10	6.16	6.20	6.23	
	6°	2.74	3.02	3.32	3.61	3.91	4.21	4.49	4.74	4.96	5.16	5.33	5.47	5.58	5.67	5.73	5.77	5.80	
	7°	2.58	2.83	3.10	3.36	3.63	3.90	4.15	4.38	4.58	4.77	4.92	5.05	5.15	5.24	5.30	5.34	5.37	
	8°	2.42	2.65	2.88	3.11	3.35	3.59	3.81	4.02	4.21	4.38	4.52	4.64	4.74	4.81	4.87	4.92	4.95	
	9°	2.24	2.44	2.65	2.86	3.07	3.28	3.48	3.67	3.84	3.99	4.12	4.23	4.32	4.39	4.45	4.50	4.53	
	10°	2.06	2.24	2.43	2.61	2.80	2.98	3.16	3.33	3.48	3.61	3.73	3.83	3.91	3.98	4.03	4.08	4.11	
	11°	1.88	2.03	2.20	2.36	2.52	2.68	2.83	2.98	3.12	3.24	3.34	3.43	3.50	3.57	3.62	3.66	3.69	
	12°	1.69	1.82	1.96	2.10	2.24	2.38	2.51	2.64	2.76	2.87	2.96	3.04	3.10	3.16	3.21	3.25	3.27	
	13°	1.49	1.61	1.73	1.84	1.96	2.08	2.20	2.31	2.41	2.50	2.58	2.65	2.71	2.76	2.80	2.83	2.85	
	14°	1.29	1.39	1.49	1.58	1.68	1.78	1.88	1.97	2.06	2.13	2.20	2.26	2.31	2.36	2.39	2.42	2.44	
15°	1.09	1.16	1.24	1.32	1.40	1.48	1.56	1.64	1.71	1.77	1.83	1.88	1.92	1.96	1.98	2.01	2.03		

OIV-MA-AS312-02: R2009
9

16°	0.88	0.94	1.00	1.06	1.12	1.19	1.25	1.31	1.36	1.41	1.46	1.50	1.53	1.56	1.58	1.60	1.62
17°	0.67	0.71	0.75	0.80	0.84	0.89	0.94	0.98	1.02	1.05	1.09	1.12	1.14	1.17	1.18	1.20	1.21
18°	0.45	0.48	0.51	0.53	0.56	0.59	0.62	0.65	0.68	0.70	0.72	0.74	0.76	0.78	0.79	0.80	0.81
19°	0.23	0.24	0.25	0.27	0.28	0.30	0.31	0.33	0.34	0.35	0.36	0.37	0.38	0.39	0.40	0.41	0.41

TABLE II (continued)
International alcoholic strength at 20°C

Table of Corrections to be applied to the apparent alcoholic strength to correct for the effect of temperature and or subtract from the apparent alcoholic strength at $t^{\circ}\text{C}$ (ordinary glass alcohol meter) the correction indicated below

		Apparent alcoholic strength at $t^{\circ}\text{C}$																	
		14	15	16	17	18	19	20	21	22	23	24	25	26	27	28	29	30	
Temperatures	To subtract	21°	0.23	0.25	0.26	0.28	0.29	0.30	0.31	0.33	0.34	0.35	0.35	0.37	0.38	0.38	0.39	0.39	0.40
		22°	0.47	0.49	0.52	0.55	0.57	0.60	0.62	0.65	0.67	0.70	0.72	0.74	0.75	0.76	0.78	0.79	0.80
		23°	0.70	0.74	0.78	0.82	0.86	0.90	0.93	0.97	1.01	1.04	1.07	1.10	1.12	1.15	1.17	1.18	1.19
		24°	0.94	0.99	1.04	1.10	1.15	1.20	1.25	1.29	1.34	1.39	1.43	1.46	1.50	1.53	1.55	1.57	1.59
		25°	1.19	1.25	1.31	1.37	1.43	1.49	1.56	1.62	1.68	1.73	1.78	1.83	1.87	1.90	1.94	1.97	1.99
		26°	1.43	1.50	1.57	1.65	1.73	1.80	1.87	1.94	2.01	2.07	2.13	2.19	2.24	2.28	2.32	2.35	2.38
		27°	1.68	1.76	1.84	1.93	2.01	2.10	2.18	2.26	2.34	2.41	2.48	2.55	2.61	2.66	2.70	2.74	2.77
		28°	1.93	2.02	2.11	2.21	2.31	2.40	2.49	2.58	2.67	2.76	2.83	2.90	2.98	3.03	3.08	3.13	3.17
		29°	2.19	2.29	2.39	2.50	2.60	2.70	2.81	2.91	3.00	3.09	3.18	3.26	3.34	3.40	3.46	3.51	3.55
		30°	2.45	2.56	2.67	2.78	2.90	3.01	3.12	3.23	3.34	3.44	3.53	3.62	3.70	3.77	3.84	3.90	3.95
		31°	2.71	2.83	2.94	3.07	3.19	3.31	3.43	3.55	3.67	3.78	3.88	3.98	4.07	4.15	4.22	4.28	4.33
		32°	2.97	3.09	3.22	3.36	3.49	3.62	3.74	3.87	4.00	4.11	4.22	4.33	4.43	4.51	4.59	4.66	4.72
		33°	3.24	3.37	3.51	3.65	3.79	3.92	4.06	4.20	4.33	4.45	4.57	4.68	4.79	4.88	4.97	5.04	5.10
		34°	3.51	3.65	3.79	3.94	4.09	4.23	4.37	4.52	4.66	4.79	4.91	5.03	5.15	5.25	5.34	5.42	5.49
		35°	3.78	3.93	4.08	4.23	4.38	4.53	4.69	4.84	4.98	5.12	5.26	5.38	5.50	5.61	5.71	5.80	5.87
		36°	4.05	4.21	4.37	4.52	4.68	4.84	5.00	5.16	5.31	5.46	5.60	5.73	5.86	5.97	6.08	6.17	6.25
		37°	4.33	4.49	4.65	4.82	4.98	5.15	5.31	5.48	5.64	5.80	5.95	6.09	6.22	6.33	6.44	6.54	6.63
	38°	4.61	4.77	4.94	5.12	5.29	5.46	5.63	5.80	5.97	6.13	6.29	6.43	6.57	6.69	6.81	6.92	7.01	
	39°	4.90	5.06	5.23	5.41	5.59	5.77	5.94	6.12	6.30	6.47	6.63	6.78	6.93	7.06	7.18	7.29	7.39	
	40°	5.19	5.36	5.53	5.71	5.90	6.08	6.26	6.44	6.62	6.80	6.97	7.13	7.28	7.41	7.54	7.66	7.76	

12
OIV-MA-AS312-02: R2009

TABLE III (continued) International alcoholic strength at 20°C

Table of apparent densities of ethanol-water mixtures - Ordinary glass apparatus Densities at t°C corrected for air buoyancy

COMPENDIUM OF INTERNATIONAL ANALYSIS OF METHODS-OIV
Alcoholic strength by volume

t°	Alcoholic strength in %																							
	0	1	2	3	4	5	6	7	8	9	10	11												
20	998.20	1.50	996.70	1.47	995.23	1.42	993.81	1.40	992.41	1.35	991.06	1.33	989.73	1.30	988.43	1.27	987.16	1.24	985.92	1.21	984.71	1.19	983.52	1.17
21	998.01	1.50	996.51	1.47	995.04	1.42	993.62	1.40	992.22	1.36	990.86	1.33	989.53	1.31	988.22	1.27	986.95	1.25	985.70	1.22	984.48	1.19	983.29	1.17
22	987.81	1.50	996.31	1.46	994.85	1.43	993.42	1.40	992.02	1.36	990.66	1.34	989.32	1.31	988.01	1.28	986.73	1.25	985.48	1.23	984.25	1.20	983.05	1.18
23	997.60	1.50	996.10	1.46	994.64	1.43	993.21	1.40	991.81	1.37	990.44	1.34	989.10	1.31	987.79	1.29	986.50	1.26	985.24	1.23	984.01	1.21	982.80	1.19
24	997.39	1.50	995.89	1.47	994.42	1.43	992.99	1.40	991.59	1.37	990.22	1.35	988.87	1.31	987.56	1.29	986.27	1.27	985.00	1.24	983.76	1.22	982.54	1.20
25	997.16	1.50	995.66	1.47	994.19	1.43	992.76	1.41	991.35	1.37	989.98	1.35	988.63	1.32	987.31	1.29	986.02	1.27	984.75	1.25	983.50	1.23	982.27	1.21
26	996.93	1.50	995.43	1.47	993.96	1.44	992.52	1.41	991.11	1.37	989.74	1.35	988.39	1.33	987.06	1.30	985.76	1.28	984.48	1.25	983.23	1.24	981.99	1.22
27	996.68	1.50	995.18	1.47	993.71	1.44	992.27	1.41	990.86	1.38	989.48	1.35	988.13	1.33	986.80	1.31	985.49	1.29	994.20	1.26	982.94	1.24	981.70	1.23
28	996.43	1.50	994.93	1.48	993.45	1.44	992.01	1.41	990.60	1.38	989.22	1.36	987.86	1.34	986.52	1.31	985.21	1.29	983.92	1.27	982.65	1.25	981.40	1.23
29	996.17	1.51	994.66	1.48	993.18	1.44	991.74	1.41	990.33	1.39	988.94	1.36	987.58	1.34	986.24	1.32	984.92	1.29	983.63	1.28	982.35	1.26	981.09	1.24
30	995.90	1.51	994.39	1.48	992.91	1.45	991.46	1.41	990.05	1.39	988.66	1.37	987.29	1.34	985.95	1.32	984.63	1.30	983.33	1.29	982.04	1.27	980.77	1.25
31	995.61	1.51	994.10	1.48	992.62	1.45	991.17	1.42	989.75	1.39	988.36	1.37	986.99	1.35	985.64	1.33	984.31	1.30	983.01	1.29	981.72	1.27	980.45	1.26
32	995.32	1.51	993.81	1.48	992.33	1.45	990.88	1.42	989.45	1.40	988.05	1.37	986.68	1.35	985.33	1.33	984.00	1.31	982.69	1.30	981.39	1.28	980.11	1.26
33	995.02	1.52	993.50	1.48	992.02	1.45	990.57	1.43	989.14	1.40	987.74	1.37	986.37	1.36	985.01	1.34	983.67	1.31	982.36	1.31	981.05	1.28	979.77	1.27
34	994.72	1.53	993.19	1.48	991.71	1.45	990.26	1.43	988.83	1.41	987.42	1.38	986.04	1.36	984.68	1.34	983.34	1.32	982.02	1.31	980.71	1.29	979.42	1.28
35	994.40	1.53	992.87	1.48	991.39	1.46	989.93	1.43	988.50	1.41	987.09	1.38	985.71	1.36	984.35	1.34	983.01	1.33	981.68	1.31	980.37	1.30	979.07	1.29
36	994.08	1.53	992.55	1.49	991.06	1.46	989.60	1.43	988.17	1.41	986.76	1.39	985.37	1.36	984.01	1.35	982.66	1.33	981.33	1.32	980.01	1.31	978.70	1.29
37	993.75	1.54	992.21	1.49	990.72	1.46	989.26	1.44	987.82	1.41	986.41	1.39	985.02	1.37	983.65	1.35	982.30	1.33	980.97	1.32	979.65	1.32	978.33	1.30
38	993.41	1.54	991.87	1.50	990.37	1.47	988.90	1.44	87.46	1.41	986.05	1.39	984.66	1.37	983.29	1.36	981.93	1.34	980.59	1.32	979.27	1.32	977.95	1.31
39	993.06	1.54	991.52	1.51	990.01	1.47	988.54	1.44	987.10	1.41	985.68	1.39	984.29	1.37	982.92	1.36	981.56	1.34	980.22	1.33	978.89	1.33	977.56	1.31
40	992.71	1.55	991.16	1.51	989.65	1.48	988.17	1.45	986.72	1.42	985.30	1.39	983.91	1.37	982.54	1.36	981.18	1.35	979.83	1.33	978.50	1.33	977.17	1.32

OIV-MA-AS312-02: R2009
 13

TABLE III (continued) International alcoholic strength in 20°C
 Table of apparent densities of ethanol-water mixtures - Ordinary glass apparatus Densities at t°C corrected for air buoyancy

t°	Alcoholic strength in %																							
	10	11	12	13	14	15	16	17	18	19	20	21	10	11	12	13	14	15	16	17	18	19	20	21
0	986.63	1.00	985.63	0.96	984.67	0.92	983.75	0.87	982.88	0.84	982.04	0.81	981.23	0.77	980.46	0.75	979.71	0.73	978.98	0.72	978.26	0.70	977.56	0.70
1	-0.03		-0.02		-0.01		0.00		0.02		0.04		0.05		0.07		0.09		0.11		0.13		0.15	
1	986.66	1.01	985.65	0.97	984.68	0.93	983.75	0.89	982.86	0.86	982.00	0.82	981.18	0.79	980.39	0.77	979.62	0.75	978.87	0.74	978.13	0.72	977.41	0.72
2	-0.02		-0.01		0.00		0.01		0.03		0.04		0.06		0.08		0.10		0.12		0.14		0.17	
2	986.68	1.02	985.66	0.98	984.68	0.94	983.74	0.91	982.83	0.87	981.96	0.84	981.12	0.81	980.31	0.79	979.52	0.77	978.75	0.76	977.99	0.75	977.24	0.74
3	0.00		0.01		0.02		0.04		0.05		0.06		0.08		0.10		0.12		0.14		0.16		0.18	
3	986.68	1.03	985.65	0.99	984.66	0.96	983.70	0.92	982.78	0.88	981.90	0.86	981.04	0.83	980.21	0.81	979.40	0.79	978.61	0.78	977.83	0.77	977.06	0.76
4	0.01		0.02		0.03		0.04		0.05		0.07		0.08		0.10		0.12		0.14		0.16		0.18	
4	986.67	1.04	985.63	1.00	984.63	0.97	983.66	0.93	982.73	0.90	981.83	0.87	980.96	0.85	980.11	0.83	979.28	0.81	978.47	0.80	977.67	0.79	976.88	0.79
5	0.02		0.03		0.05		0.06		0.08		0.09		0.11		0.13		0.14		0.16		0.18		0.20	
5	986.65	1.05	985.60	1.02	984.58	0.98	983.60	0.95	982.65	0.91	981.74	0.89	980.85	0.87	979.98	0.84	979.11	0.83	978.31	0.82	977.49	0.81	976.68	0.81
6	0.04		0.06		0.06		0.07		0.08		0.10		0.11		0.13		0.15		0.17		0.19		0.21	
6	986.61	1.07	985.54	1.02	984.52	0.99	983.53	0.96	982.57	0.93	981.64	0.90	980.74	0.89	979.85	0.86	978.99	0.85	978.14	0.84	977.30	0.83	976.47	0.83
7	0.05		0.06		0.08		0.09		0.10		0.12		0.14		0.15		0.17		0.19		0.20		0.22	
7	986.56	1.08	985.48	1.04	994.44	1.00	983.44	0.97	982.47	0.95	981.52	0.92	980.60	0.90	979.70	0.88	978.82	0.87	977.95	0.85	977.10	0.85	976.25	0.85
8	0.07		0.08		0.09		0.10		0.11		0.12		0.14		0.16		0.18		0.19		0.21		0.23	
8	986.49	1.09	985.40	1.05	984.35	1.01	983.34	0.98	982.36	0.96	981.40	0.94	980.46	0.92	979.54	0.90	978.64	0.88	977.76	0.87	976.89	0.87	976.02	0.97
9	0.08		0.08		0.09		0.11		0.13		0.14		0.15		0.16		0.18		0.20		0.22		0.24	
9	986.41	1.09	985.32	1.06	984.26	1.03	983.23	1.00	982.23	0.97	981.26	0.95	980.31	0.93	979.38	0.92	978.48	0.90	977.56	0.89	976.67	0.89	975.78	0.89
10	0.10		0.11		0.12		0.13		0.14		0.16		0.17		0.18		0.19		0.21		0.23		0.25	
10	986.31	1.10	985.21	1.07	984.14	1.04	983.10	1.01	982.09	0.99	981.10	0.96	980.14	0.94	979.20	0.93	918.27	0.92	977.35	0.91	976.44	0.91	975.53	0.91
11	0.10		0.11		0.12		0.13		0.15		0.16		0.17		0.19		0.21		0.23		0.25		0.27	
11	986.21	1.11	985.10	1.08	984.02	1.05	982.97	1.03	981.94	1.00	980.94	0.97	979.97	0.96	979.01	0.95	978.06	0.94	977.12	0.93	976.19	0.93	975.26	0.92
12	0.12		0.13		0.14		0.15		0.16		0.17		0.19		0.21		0.22		0.24		0.26		0.27	
12	986.09	1.12	984.97	1.09	983.88	1.06	982.82	1.04	981.78	1.01	980.77	0.99	979.78	0.98	978.80	0.96	977.84	0.96	976.88	0.95	975.93	0.94	974.99	0.94
13	0.13		0.14		0.15		0.16		0.17		0.19		0.20		0.21		0.23		0.24		0.26		0.28	
13	985.96	1.13	984.83	1.10	983.73	1.07	982.66	1.05	981.61	1.03	980.58	1.00	979.58	0.99	978.59	0.98	977.61	0.97	976.64	0.97	975.67	0.96	974.71	0.96
14	0.15		0.16		0.17		0.18		0.19		0.20		0.22		0.23		0.24		0.26		0.27		0.29	
14	985.81	1.14	984.67	1.11	983.56	1.08	982.48	1.06	981.42	1.04	980.38	1.02	979.36	1.00	978.36	0.99	977.37	0.99	976.38	0.98	975.40	0.98	974.42	0.98
15	0.15		0.16		0.17		0.18		0.19		0.20		0.22		0.24		0.26		0.27		0.28		0.30	
15	985.66	1.15	984.51	1.12	983.39	1.09	982.30	1.07	981.23	1.05	980.18	1.04	979.14	1.02	978.12	1.01	977.11	1.00	976.11	0.99	975.12	1.00	974.12	1.00
16	0.17		0.18		0.19		0.20		0.21		0.22		0.23		0.25		0.26		0.28		0.30		0.31	
16	985.49	1.16	984.33	1.13	983.20	1.10	982.10	1.08	981.02	1.06	979.96	1.05	978.91	1.04	977.87	1.02	976.85	1.02	975.83	1.01	974.82	1.01	973.81	1.02
17	0.17		0.18		0.19		0.20		0.21		0.23		0.24		0.25		0.27		0.29		0.30		0.31	
17	985.32	1.17	984.15	1.14	983.01	1.11	981.90	1.09	980.81	1.08	979.73	1.06	978.67	1.05	977.62	1.04	976.58	1.04	975.54	1.02	974.52	1.02	973.95	1.04
18	0.19		0.19		0.20		0.22		0.24		0.25		0.26		0.27		0.28		0.29		0.31		0.33	
18	985.13	1.17	983.96	1.15	982.81	1.13	981.68	1.11	980.57	1.09	979.48	1.07	978.41	1.06	977.35	1.05	976.30	1.05	975.25	1.04	974.21	1.04	973.17	1.05
19	0.20		0.21		0.22		0.23		0.24		0.25		0.26		0.27		0.29		0.30		0.32		0.34	
19	984.93	1.18	983.75	1.16	982.59	1.14	981.45	1.12	980.33	1.10	979.23	1.08	978.15	1.07	977.08	1.07	976.01	1.06	974.94	1.05	973.89	1.06	972.83	1.06
	0.22		0.23		0.24		0.24		0.25		0.26		0.28		0.29		0.30		0.31		0.33		0.35	

COMPENDIUM OF INTERNATIONAL ANALYSIS OF METHODS-OIV
 Alcoholic strength by volume

20	984.71	1.19	983.52	1.17	982.35	1.14	981.21	1.13	980.08	1.11	978.97	1.10	977.87	1.08	976.79	1.08	975.71	1.08	974.63	1.07	973.56	1.08	972.48	1.08
----	--------	------	--------	------	--------	------	--------	------	--------	------	--------	------	--------	------	--------	------	--------	------	--------	------	--------	------	--------	------

TABLE III (continued) International alcoholic strength in 20°C
 Table of apparent densities of ethanol-water mixtures - Ordinary glass apparatus Densities at t°C corrected for air buoyancy

OIV-MA-AS312-02: R2009
 15

COMPENDIUM OF INTERNATIONAL ANALYSIS OF METHODS-OIV
 Alcoholic strength by volume

t°	Alcoholic strength in %																							
	20	21	22	23	24	25	26	27	28	29	30	31	20	21	22	23	24	25	26	27	28	29	30	31
0	0.70	0.70	0.69	0.70	0.72	0.72	0.74	0.77	0.80	0.83	0.87	0.90	0.70	0.70	0.69	0.70	0.72	0.72	0.74	0.77	0.80	0.83	0.87	0.90
1	0.13	0.15	0.17	0.20	0.22	0.24	0.27	0.30	0.32	0.35	0.37	0.39	0.13	0.15	0.17	0.20	0.22	0.24	0.27	0.30	0.32	0.35	0.37	0.39
2	0.14	0.17	0.19	0.21	0.24	0.26	0.29	0.31	0.34	0.36	0.38	0.41	0.14	0.17	0.19	0.21	0.24	0.26	0.29	0.31	0.34	0.36	0.38	0.41
3	0.16	0.18	0.20	0.23	0.25	0.27	0.29	0.32	0.34	0.36	0.38	0.40	0.16	0.18	0.20	0.23	0.25	0.27	0.29	0.32	0.34	0.36	0.38	0.40
4	0.16	0.18	0.21	0.23	0.25	0.28	0.30	0.32	0.34	0.36	0.39	0.42	0.16	0.18	0.21	0.23	0.25	0.28	0.30	0.32	0.34	0.36	0.39	0.42
5	0.18	0.20	0.22	0.24	0.26	0.28	0.30	0.33	0.35	0.38	0.40	0.41	0.18	0.20	0.22	0.24	0.26	0.28	0.30	0.33	0.35	0.38	0.40	0.41
6	0.19	0.21	0.23	0.25	0.27	0.30	0.33	0.34	0.37	0.39	0.41	0.43	0.19	0.21	0.23	0.25	0.27	0.30	0.33	0.34	0.37	0.39	0.41	0.43
7	0.20	0.22	0.24	0.26	0.28	0.30	0.32	0.35	0.37	0.39	0.41	0.43	0.20	0.22	0.24	0.26	0.28	0.30	0.32	0.35	0.37	0.39	0.41	0.43
8	0.21	0.23	0.25	0.27	0.29	0.31	0.33	0.35	0.37	0.39	0.42	0.44	0.21	0.23	0.25	0.27	0.29	0.31	0.33	0.35	0.37	0.39	0.42	0.44
9	0.22	0.24	0.26	0.28	0.30	0.32	0.34	0.36	0.38	0.41	0.43	0.45	0.22	0.24	0.26	0.28	0.30	0.32	0.34	0.36	0.38	0.41	0.43	0.45
10	0.23	0.25	0.27	0.29	0.31	0.33	0.35	0.37	0.39	0.41	0.43	0.45	0.23	0.25	0.27	0.29	0.31	0.33	0.35	0.37	0.39	0.41	0.43	0.45
11	0.25	0.27	0.28	0.30	0.32	0.34	0.36	0.38	0.40	0.42	0.44	0.45	0.25	0.27	0.28	0.30	0.32	0.34	0.36	0.38	0.40	0.42	0.44	0.45
12	0.26	0.27	0.29	0.31	0.33	0.35	0.37	0.39	0.40	0.42	0.44	0.46	0.26	0.27	0.29	0.31	0.33	0.35	0.37	0.39	0.40	0.42	0.44	0.46
13	0.26	0.28	0.30	0.32	0.34	0.36	0.38	0.39	0.41	0.43	0.45	0.47	0.26	0.28	0.30	0.32	0.34	0.36	0.38	0.39	0.41	0.43	0.45	0.47
14	0.27	0.29	0.31	0.33	0.35	0.37	0.38	0.40	0.42	0.44	0.45	0.47	0.27	0.29	0.31	0.33	0.35	0.37	0.38	0.40	0.42	0.44	0.45	0.47
15	0.28	0.30	0.32	0.33	0.35	0.37	0.39	0.41	0.43	0.45	0.47	0.49	0.28	0.30	0.32	0.33	0.35	0.37	0.39	0.41	0.43	0.45	0.47	0.49
16	0.30	0.31	0.33	0.35	0.36	0.38	0.40	0.42	0.44	0.45	0.47	0.49	0.30	0.31	0.33	0.35	0.36	0.38	0.40	0.42	0.44	0.45	0.47	0.49
17	0.30	0.31	0.33	0.35	0.37	0.38	0.40	0.42	0.44	0.45	0.47	0.49	0.30	0.31	0.33	0.35	0.37	0.38	0.40	0.42	0.44	0.45	0.47	0.49
18	0.31	0.33	0.34	0.36	0.38	0.40	0.42	0.44	0.46	0.47	0.49	0.50	0.31	0.33	0.34	0.36	0.38	0.40	0.42	0.44	0.46	0.47	0.49	0.50
19	0.32	0.34	0.35	0.36	0.38	0.40	0.42	0.44	0.46	0.47	0.49	0.50	0.32	0.34	0.35	0.36	0.38	0.40	0.42	0.44	0.46	0.47	0.49	0.50
20	0.33	0.35	0.37	0.39	0.40	0.41	0.42	0.45	0.46	0.48	0.51	0.52	0.33	0.35	0.37	0.39	0.40	0.41	0.42	0.45	0.46	0.48	0.51	0.52
20	1.08	1.08	1.08	1.09	1.10	1.11	1.13	1.14	1.17	1.20	1.23	1.29	1.08	1.08	1.08	1.09	1.10	1.11	1.13	1.14	1.17	1.20	1.23	1.29

TABLE III (continued) International alcoholic strength in 20°C
Table of apparent densities of ethanol-water mixtures - Ordinary glass apparatus Densities at t°C corrected for air buoyancy

t°	Alcoholic strength at %																							
	20		21		22		23		24		25		26		27		28		29		30		31	
20	0.35	1.08	0.36	1.08	0.37	1.09	0.39	1.10	0.40	1.11	0.42	1.13	0.44	1.16	0.45	1.17	0.47	1.20	0.49	1.23	0.50	1.26	0.52	1.29
21	0.35	1.09	0.36	1.09	0.38	1.11	0.39	1.11	0.41	1.13	0.43	1.15	0.44	1.17	0.46	1.19	0.48	1.22	0.49	1.24	0.51	1.28	0.52	1.31
22	0.35	1.10	0.37	1.11	0.39	1.12	0.40	1.13	0.42	1.15	0.43	1.16	0.45	1.19	0.46	1.21	0.48	1.23	0.50	1.26	0.52	1.29	0.53	1.32
23	0.36	1.12	0.38	1.13	0.39	1.13	0.41	1.15	0.42	1.16	0.44	1.18	0.46	1.20	0.48	1.23	0.49	1.25	0.51	1.28	0.53	1.30	0.54	1.33
24	0.38	1.14	0.39	1.14	0.40	1.15	0.42	1.16	0.44	1.18	0.45	1.20	0.46	1.22	0.48	1.24	0.50	1.27	0.51	1.29	0.53	1.32	0.54	1.34
25	0.38	1.15	0.39	1.15	0.41	1.17	0.42	1.18	0.44	1.19	0.46	1.21	0.48	1.24	0.49	1.26	0.50	1.28	0.52	1.31	0.53	1.33	0.55	1.36
26	0.39	1.16	0.41	1.17	0.42	1.18	0.44	1.20	0.45	1.21	0.46	1.23	0.48	1.25	0.50	1.27	0.51	1.30	0.52	1.32	0.53	1.35	0.55	1.38
27	0.40	1.18	0.41	1.18	0.43	1.20	0.44	1.21	0.46	1.22	0.48	1.25	0.49	1.27	0.50	1.28	0.52	1.31	0.53	1.33	0.55	1.37	0.56	1.40
28	0.40	1.19	0.42	1.20	0.43	1.21	0.45	1.23	0.46	1.24	0.48	1.26	0.49	1.28	0.50	1.30	0.52	1.32	0.54	1.35	0.55	1.38	0.56	1.41
29	0.42	1.21	0.43	1.21	0.45	1.23	0.46	1.24	0.47	1.26	0.48	1.27	0.50	1.29	0.52	1.32	0.53	1.34	0.54	1.36	0.56	1.39	0.58	1.43
30	0.42	1.22	0.43	1.23	0.44	1.24	0.45	1.25	0.47	1.27	0.49	1.29	0.51	1.31	0.52	1.33	0.53	1.35	0.55	1.38	0.56	1.41	0.58	1.44
31	0.43	1.23	0.45	1.24	0.46	1.25	0.48	1.27	0.49	1.29	0.50	1.31	0.51	1.32	0.52	1.34	0.54	1.37	0.56	1.39	0.57	1.43	0.58	1.45
32	0.43	1.25	0.45	1.25	0.47	1.27	0.48	1.28	0.50	1.30	0.51	1.32	0.52	1.33	0.54	1.36	0.55	1.39	0.56	1.40	0.58	1.44	0.59	1.47
33	0.45	1.27	0.45	1.27	0.47	1.28	0.49	1.30	0.50	1.31	0.51	1.33	0.52	1.35	0.54	1.37	0.55	1.40	0.56	1.42	0.58	1.45	0.60	1.48
34	0.45	1.27	0.47	1.29	0.48	1.30	0.49	1.31	0.50	1.32	0.52	1.34	0.53	1.37	0.55	1.38	0.57	1.41	0.58	1.44	0.59	1.47	0.60	1.49
35	0.45	1.29	0.47	1.30	0.48	1.31	0.49	1.32	0.51	1.34	0.53	1.36	0.54	1.38	0.55	1.40	0.57	1.42	0.58	1.45	0.60	1.48	0.61	1.50
36	0.46	1.31	0.47	1.31	0.48	1.32	0.50	1.34	0.52	1.36	0.53	1.37	0.55	1.39	0.56	1.42	0.57	1.44	0.58	1.46	0.60	1.49	0.61	1.51
37	0.47	1.32	0.48	1.32	0.50	1.34	0.51	1.36	0.52	1.37	0.54	1.39	0.55	1.40	0.57	1.43	0.58	1.45	0.59	1.48	0.60	1.50	0.62	1.52
38	0.48	1.33	0.49	1.34	0.51	1.35	0.52	1.37	0.53	1.39	0.54	1.40	0.56	1.42	0.57	1.44	0.58	1.46	0.60	1.49	0.61	1.51	0.62	1.54
39	0.49	1.34	0.50	1.36	0.51	1.36	0.53	1.38	0.54	1.40	0.55	1.42	0.56	1.43	0.58	1.45	0.60	1.48	0.61	1.50	0.62	1.52	0.64	1.55

16 OIV-MA-AS312-02: R2009

COMPENDIUM OF INTERNATIONAL ANALYSIS OF METHODS-OIV
Alcoholic strength by volume

40	965.25	1.35	963.90	1.37	962.53	1.38	961.15	1.39	959.76	1.41	958.35	1.43	956.92	1.45	955.47	1.47	954.00	1.49	952.51	1.51	951.00	1.54	949.49	1.56
----	--------	------	--------	------	--------	------	--------	------	--------	------	--------	------	--------	------	--------	------	--------	------	--------	------	--------	------	--------	------

TABLE IV
Table giving the refractive indices of pure ethanol-water mixtures
and distillates at 20°C
and the corresponding alcoholic strengths at 20°C

Refractive index at 20°C	Alcoholic strength at 20°C				Refractive index at 20°C	Alcoholic strength at 20°C			
	Water-ethanol mixtures		Distillates			Water-ethanol mixtures		Distillates	
1.33628	6.54	0.25	6.48	0.26	1.34222	16.76	0.23	16.65	0.23
1.33642	6.79	0.26	6.74	0.26	1.34236	16.99	0.23	16.88	0.24
1.33656	7.05	0.25	7.00	0.27	1.34250	17.22	0.22	17.12	0.22
1.33670	7.30	0.28	7.27	0.27	1.34264	17.44	0.24	17.34	0.22
1.33685	7.58	0.25	7.54	0.25	1.34278	17.68	0.21	17.56	0.22
1.33699	7.83	0.26	7.79	0.26	1.34291	17.89	0.23	17.78	0.23
1.33713	8.09	0.25	8.05	0.25	1.34305	18.12	0.24	18.01	0.22
1.33727	8.34	0.28	8.30	0.26	1.34319	18.36	0.23	18.23	0.23
1.33742	8.62	0.25	8.56	0.25	1.34333	18.59	0.23	18.46	0.24
1.33756	8.87	0.25	8.81	0.25	1.34347	18.82	0.23	18.70	0.22
1.33770	9.12	0.24	9.06	0.24	1.34361	19.05	0.23	18.92	0.25
1.33784	9.36	0.27	9.30	0.25	1.34375	19.28	0.23	19.17	0.23
1.33799	9.63	0.24	9.55	0.26	1.34389	19.51	0.24	19.40	0.22
1.33813	9.87	0.25	9.81	0.24	1.34403	19.75	0.23	19.62	0.24
1.33827	10.12	0.23	10.05	0.24	1.34417	19.98	0.24	19.86	0.23
1.33841	10.35	0.26	10.29	0.25	1.34431	20.22	0.22	20.09	0.24
1.33856	10.61	0.25	10.54	0.24	1.34445	20.44	0.21	20.33	0.21
1.33870	10.86	0.24	10.78	0.24	1.34458	20.65	0.24	20.54	0.22
1.33884	11.10	0.23	11.02	0.24	1.34472	20.89	0.22	20.76	0.23
1.33898	11.33	0.24	11.26	0.24	1.34486	21.11	0.23	20.99	0.22
1.33912	11.47	0.24	11.50	0.24	1.34500	21.34	0.21	21.21	0.23
1.33926	11.81	0.24	11.74	0.24	1.34513	21.55	0.23	21.44	0.21
1.33940	12.05	0.25	11.98	0.24	1.34527	21.78	0.22	21.65	0.22
1.33955	12.30	0.23	12.22	0.24	1.34541	22.00	0.23	21.87	0.23
1.33969	12.53	0.23	12.46	0.23	1.34555	22.23	0.21	22.10	0.21
1.33983	12.76	0.24	12.69	0.23	1.34568	22.44	0.23	22.31	0.23
1.33997	13.00	0.23	12.92	0.23	1.34582	22.67	0.23	22.54	0.21
1.34011	13.23	0.24	13.15	0.25	1.34596	22.90	0.23	22.75	0.21
1.34025	13.47	0.23	13.40	0.22	1.34610	23.13	0.20	22.96	0.21
1.34039	13.70	0.23	13.62	0.24	1.34623	23.33	0.24	23.17	0.23
1.34053	13.93	0.23	13.86	0.23	1.34637	23.57	0.24	23.40	0.21
1.34067	14.16	0.25	14.09	0.23	1.34651	23.81	0.23	23.61	0.24
1.34081	14.41	0.25	14.32	0.25	1.34665	24.04	0.22	23.85	0.24
1.34096	14.66	0.23	14.57	0.24	1.34678	24.26	0.22	24.09	0.22
1.34110	14.89	0.24	14.81	0.25	1.34692	24.48	0.24	24.31	0.25
1.34124	15.13	0.23	15.06	0.22	1.34706	24.72	0.23	24.56	0.22
1.34138	15.36	0.23	15.28	0.22	1.34720	24.95	0.21	24.78	0.22
1.34152	15.59	0.24	15.50	0.24	1.34733	25.16	0.24	25.00	0.23
1.34166	15.83	0.23	15.74	0.22	1.34747	25.40	0.22	25.23	0.22
1.34180	16.06	0.23	15.96	0.23	1.34760	25.62	0.24	25.45	0.25
1.34194	16.29	0.23	16.19	0.22	1.34774	25.86	0.24	25.70	0.23
1.34208	16.52	0.24	16.41	0.24	1.34788	26.10	0.22	25.93	0.22

OIV-MA-AS312-02: R2009

Method OIV-MA-AS312-03A

Type II method

Methanol

A41 revised by OIV/OENO 377/2009
OIV-OENO 480-2014)

1. Scope of application

This method is applicable to the determination of methanol in wine for concentrations between 50 and 500 mg/L.

2. Principle

Methanol is determined in the distillate, to which an internal standard is added, using gas chromatography with a flame ionisation detector (FID).

3. Reagents and materials

3.1. Type II water, according to ISO standard 3696

3.2. Ethanol: purity ≥ 96 % (CAS no. 64-17-5)

3.3. Hydrogen: minimum specifications: 99.999% purity (CAS no. 1333-74-0)

3.4. Helium: minimum specifications: 99.999% purity (CAS no. 7440-59-7)

3.5. Methanol: purity ≥ 99 % (CAS no. 67-56-1)

3.6. 4-Methyl-2-pentanol (internal standard): purity ≥ 98 % (CAS no. 108-11-2).

Internal standard used in the validation.

Note 1: Other internal standards can be used, such as:

- 3-pentanol: purity ≥ 98 % (CAS no. 584-02-1)
- 4-methyl-1-pentanol: purity ≥ 98 % (CAS no. 626-89-1)
- Methyl nonanoate: purity ≥ 98 % (CAS no. 1731-84-6)

COMPENDIUM OF INTERNATIONAL METHODS OF ANALYSIS-OIV
Methanol

3.7. Reference materials: these may be, for example, wines from laboratory proficiency tests.

3.8. Preparation of working solutions (by way of example):

3.8.1. Approximately 10% v/v aqueous-alcoholic mixture

This mixture should be as close as possible to the alcohol content of the wine to be analysed. Pour 100 mL of ethanol (3.2) into a 1 L calibrated flask (4.2), make up to volume with demineralised water (3.1) and mix.

3.8.2. 10 g/L Internal standard solution

Using an analytical balance (4.1), weigh approximately 1 g of internal standard (3.6) into a 100 mL calibrated flask (4.3) that contains around 60 mL of 10% ethanol solution (3.8.1), so as to minimise evaporation of the internal standard. Make up to volume with the ethanol solution (3.8.1) and mix.

3.8.3. 1 g/L Internal standard solution

Add 10 mL of the 10 g/L internal standard solution (3.8.2) using a pipette (4.8) and make up to 100 mL (4.3) using the 10% v/v hydroalcoholic mixture (3.8.1).

3.8.4. 5 g/L Methanol stock solution

Using an analytical balance (4.1), weigh approximately 500 mg of methanol (3.5) into a 100 mL calibrated flask (4.3) that contains about 60 mL of 10% ethanol solution (3.8.1), so as to minimise evaporation of the methanol. Make up to volume with the ethanol solution (3.8.1) and mix.

3.8.5. Working calibration solutions

By way of example, a method for plotting a calibration curve is outlined below.

COMPENDIUM OF INTERNATIONAL METHODS OF ANALYSIS-OIV
Methanol

Each solution should be prepared with the 10% aqueous-alcoholic mixture (3.8.1).

3.8.5.1. 500 mg/L Methanol standard solution

Add 10 mL of the 5 g/L stock solution (3.8.4) to a 100 mL calibrated flask (4.3) using a pipette (4.8) and make up to volume with the 10% v/v ethanol solution (3.8.1).

3.8.5.1.1. 250 mg/L Methanol standard solution

Add 10 mL of the 500 mg/L methanol solution (3.8.5.1) to a 20 mL calibrated flask (4.5) using a pipette (4.8) and make up to volume with the 10% v/v ethanol solution (3.8.1).

3.8.5.1.2. 200 mg/L Methanol standard solution

Add 20 mL of the 500 mg/L methanol solution (3.8.5.1) to a 50 mL calibrated flask (4.4) using a pipette (4.7) and make up to volume with the 10% v/v ethanol solution (3.8.1).

3.8.5.1.3. 150 mg/L Methanol standard solution

Add 6 mL of the 500 mg/L methanol solution (3.8.5.1) to a 20 mL calibrated flask (4.5) using a pipette (4.9) and make up to volume with the 10% v/v ethanol solution (3.8.1).

3.8.5.1.4. 100 mg/L Methanol standard solution

Add 4 mL of the 500 mg/L methanol solution (3.8.5.1) to a 20 mL calibrated flask (4.5) using a pipette (4.10) and make up to volume with the 10% v/v ethanol solution (3.8.1).

3.8.5.1.5. 50 mg/L Methanol standard solution

Add 2 mL of the 500 mg/L methanol solution (3.8.5.1) to a 20 mL calibrated flask (4.5) using a pipette (4.11) and make up to volume with the 10% v/v ethanol solution (3.8.1).

4. Apparatus

- 4.1. Analytical balance (1 mg precision)
- 4.2. 1 L Class A calibrated flasks
- 4.3. 100 mL Class A calibrated flasks
- 4.4. 50 mL Class A calibrated flasks
- 4.5. 20 mL Class A calibrated flasks
- 4.6. 10 mL Class A calibrated flasks
- 4.7. 20 mL Class A pipettes with two marks
- 4.8. 10 mL Class A pipettes with two marks
- 4.9. 6 mL Class A pipettes with two marks
- 4.10. 4 mL Class A pipettes with two marks
- 4.11. 2 mL Class A pipettes with two marks
- 4.12. 1 mL Class A pipettes with two marks or 1 mL micropipettes
- 4.13. Temperature-programmable gas chromatograph with a flame ionisation detector and a data processing system capable of calculating areas or measuring peak heights
- 4.14. Fused silica capillary column coated with a Carbowax 20M-type polar stationary phase (for example):
 - Chrompack CP-wax 57 CB, 50 m x 0.32 mm x 0.45 μm
 - DB-WAX 52, 30 m x 25 μm x 0.2 μm

5. Sample preparation

Sparkling and/or young wines must be pre-degassed, for example, by mixing 200 mL of wine in a 1 L flask. Subsequently, the samples are distilled according to the method for determining alcoholic strength by volume (OIV-MA-AS312-01). The distillation can be carried out without adding calcium hydroxide in this case.

COMPENDIUM OF INTERNATIONAL METHODS OF ANALYSIS-OIV Methanol

5.1. Addition of internal standard (by way of example)

Pour 10 mL of distillate into a 10 mL calibrated flask (4.6), add 1 mL (4.12) of internal standard solution (3.8.3) and mix.

6. Procedure

The calibration curve standards are treated in the same way as the samples (point 5.1).

It is recommended that the aqueous-alcoholic mixture (3.8.1) is injected at the start of the sequence in order to verify that it does not contain methanol.

6.1. Operating conditions (as a guide):

Carrier gas: helium or hydrogen

Carrier gas flow: 7 mL/min

Injection: split (ratio: 7:50)

Injection volume: 1 or 2 µL

Injector temperature: 200-260 °C

Detector temperature: 220-300 °C

Temperature programme: from 35 °C (for 2 minutes) to 170 °C, at 7.5 °C/min

7. Calculations

Calculate the concentration of methanol (C_i), using the following equation:

$$C_i = \frac{C_p}{m} \left(\frac{A_i}{A_p} - b \right)$$

A_i – Peak area of methanol

A_p – Peak area of internal standard

C_p – Concentration of internal standard

m - Slope of the calibration curve

b - Y-intercept of the calibration curve

8. Expression of the results

The concentration of methanol may be expressed in mg/L or in mg/100 mL absolute alcohol; in the latter case, the alcohol content by volume of the wine should be determined.

Note 2: mg/100 mL absolute alcohol = mg/L x 10/alcohol content by volume

9. Precision

The data from the international interlaboratory test is outlined in Annex A.

10. Quality control

Internal quality control may be carried out using certified reference materials or wines whose characteristics have been determined from a consensus (3.7). These should be prepared as for the samples (point 5). Participation in proficiency tests is recommended.

11. Report of the results

The results are expressed to the nearest whole number (in accordance with the uncertainty).

12. Bibliography

Compendium of international methods of wine and must analysis. Method OIV-MA-AS312-01 (Alcoholic strength).

COMPENDIUM OF INTERNATIONAL METHODS OF ANALYSIS-OIV
Methanol

Annex A

Statistical results of the interlaboratory test

Design of validation study

The validation study was conducted with 10 samples: 2 white wines, one dry and one sweet, 2 red wines, one of which was oaked, and 1 fortified wine (Port), including blind duplicates, according to OIV recommendations. The approximate concentration of methanol is shown in the following table.

Sample	White wine Dry	White wine Sweet	Red wine	Red wine oaked	Fortified wine port
Methanol (mg/L)	50	150*	270	400*	120

(*) In this particular indicated case, methanol was added to the wine to cover a greater range of concentrations. The wine was then mixed, stabilised and bottled.

Participating laboratories:

Samples were sent to 17 laboratories in 9 different countries.

Laboratorios Agroalimentarios, Madrid (Spain)

Estación de Viticultura y Enología de Galicia, EVEGA (Spain)

Estació de Viticultura i Enologia de Vilafranca del Penedès, (Spain)

Estación Enológica de Haro, La Rioja (Spain)

Estación de Viticultura y Enología de Galicia (Spain)

Lab. Bordeaux, Service Commun des Lab., Pessac (France)

Laboratoire d'Ile-de-France, Paris (France)

Laboratoires Inter Rhône (France)

Comité Interprof. du Vin de Champagne (CIVC) (France)

Bfr-Bundesinst. f. Risikobewertung (Germany)

Landesuntersuchungsamt Mainz (Germany)

OIV-MA-AS312-03A : R2014

COMPENDIUM OF INTERNATIONAL METHODS OF ANALYSIS-OIV
Methanol

Instituto Nacional de Vitivinicultura, Mendoza (Argentina)

ALKO Inc., Alcohol Control Lab. (ACL) (Finland)

Instituto dos Vinhos do Douro e do Porto (Portugal)

Czech Agriculture and Food Inspection Authority (CAFIA), Brno (Czech Republic) CZ

National Food Safety Office, Directorate of Oenology and Alcoholic Beverages (NÉBIH BAI),
Budapest (Hungary)

Lehr- und Forschungszentrum, Klosterneuburg (Austria)

	Dry white		Sweet white		Red		Oaked red		Port	
Laboratory code	A	G	B	H	C	I	D	J	E	K
A	39.99	38.13	127.42	136.25	144.80	145.71	496.53	513.00	192.13	219.39
B	41.20	40.90	157.60	160.50	150.40	146.90	484.90	477.80	222.40	219.60
C	36.80	35.60	133.50	129.20	119.10	134.10	454.10	478.40	197.00	174.80
D	36.00	39.60	177.40	145.50	160.80	138.00	302.00	494.50	216.10	248.50
E	68.00	70.00	163.00	169.00	178.00	177.00	503.00	495.50	225.00	227.00
F	37.00	37.10	148.30	148.20	143.40	142.40	484.10	474.00	206.30	206.90
G	41.40	42.30	152.60	152.40	149.70	150.50	489.60	491.10	216.60	217.20
H	36.80	32.40	140.80	129.10	128.00	137.70	440.60	429.30	187.50	192.80
I	42.90	43.30	153.50	155.50	139.70	147.40	468.30	456.10	225.30	225.60
J	40.90	40.60	155.50	154.60	148.50	149.10	496.40	499.80	217.10	217.00
K	39.30	36.20	103.10	143.10	131.90	115.90	437.90	334.00	156.10	172.60
L	35.0	39.00	164.00	167.00	157.00	160.00	492.00	508.00	249.00	220.00

M	43.60	43.40	157.30	154.90	155.50	158.90	506.80	496.10	217.70	219.50
N	34.20	33.60	126.50	125.70	125.90	133.60	429.10	429.00	192.10	188.90
O	34.00	35.70	149.00	154.80	144.20	141.80	482.80	473.60	210.40	218.10
P	44.70	43.70	151.60	146.00	140.70	147.60	451.20	472.80	205.40	205.80
Q	40.70	38.80	Collaborative	study	on		498.20	497.50	225.50	217.20

OIV-MA-AS312-03A :
R2015

Note: The values in bold correspond to values rejected according to the Cochran (variance outliers) and Grubbs (mean outliers) test **S**.

Indicators	Dry white	Sweet white	Red	Oaked red	Port
Number of accepted laboratories	16	15	17	15	17
Number of repetitions	2	2	2	2	2
Minimum	32.40	125.70	115.90	429.00	156.10
Maximum	44.70	169.00	178.00	513.00	249.00
Repeatability variance s_r^2	2.2466	12.1330	39.0164	76.3567	105.3390
Intergroup variance s_r^2	9.61893	146.39249	151.90249	535.61827	292.14282
Reproducibility variance s_r^2	11.8655	158.5254	190.9189	611.9750	397.4819
Overall mean	38.90	148.92	145.76	478.97	210.37
Repeatability standard deviation	1.50	3.48	6.25	8.74	10.26
r Limit	4.242	9.858	17.677	24.729	29.046
Repeatability CV	3.9	2.3	4.3	1.8	4.9
Reproducibility standard deviation	3.44	12.59	13.82	24.74	19.94
R Limit	9.748	35.632	39.103	70.009	56.422
Reproducibility CV	8.9	8.5	9.5	5.2	9.5
Horwitz RSD	6.09	4.97	4.99	4.17	4.72
Horrat r	0.6	0.5	0.9	0.4	1.0
Horwitz RSD	9.22	7.53	7.56	6.32	7.15
Horrat R	1.0	1.1	1.3	0.8	1.3

According to the Horrat values, the repeatability and reproducibility of the method are acceptable

Z-scores obtained by the participants: of the 85 Z-scores, 3 are unsatisfactory and 4 are questionable

	Z-score	Z-score	Z-score	Z-score	Z-score
Laboratory code	Dry white wine	Sweet white wine	Red wine	Oaked red wine	Port
A	0.05	-1.36	-0.04	1.04	-0.23
B	0.62	0.80	0.21	0.10	0.53
C	-0.78	-1.40	-1.39	-0.51	-1.23
D	-0.32	1.00	0.26	-3.26	1.10
E	8.74	1.36	2.30	0.81	0.78
F	-0.54	-0.05	-0.21	0.00	-0.19
G	0.66	0.28	0.31	0.46	0.33
H	0.55	-1.11	-0.93	-1.78	-1.01
I	1.22	0.44	-0.16	-0.68	0.76
J	0.54	0.49	0.22	0.77	0.34
K	-0.33	-2.05	-1.58	-3.76	-2.31
L	-0.55	1.32	0.92	0.85	1.21
M	1.34	0.57	0.83	0.91	0.41
N	-1.45	-1.81	-1.16	-2.02	-1.00
O	-1.18	0.24	-0.20	-0.03	0.19
P	1.54	0.03	-0.12	-0.69	-0.24
Q	0.25	0.20	0.73	0.76	0.55

03A :
 R2015
 QIV-MA
 AS312-

Methanol

(A41 revised by OIV/OENO 377/2009)

1. Principle

The wine distillate is diluted to an ethanol content of 5% (v/v). Methanol is oxidized to formaldehyde (methanol) by potassium permanganate (acidified by phosphoric acid). The amount of formaldehyde is determined by the violet color formed by the reaction of chromotropic acid in a sulfuric medium. The intensity of the color is determined by spectrophotometry at 575 nm.

2.. Method

2.1 Reagents

2.1.1 Chromotropic Acid

4,5-Dihydroxy-2,7-naphthalenedisulfonic acid,
($C_{10}H_8O_8S_2 \cdot 2H_2O$), (MW 356.34 g)

White or light brown powder, soluble in water. The *di*-sodium salt of this acid that forms a yellow or light brown substance, and is very soluble in water can also be used.

Purification - The chromotropic acid must be pure and give a negligible color in the blank tests of reagents prepared with it. If this is not the case, proceed with purification using the following procedure:

Dissolve 10 g of chromotropic acid or its salt in 25 mL of distilled water. If the salt has been used, add 2 mL of concentrated sulfuric acid ($\rho_{20} = 1.84$ g/mL) to release the acid. Add 50 mL of methanol, heat to boiling and filter. Add 100 mL of *iso*-propanol to precipitate the pure crystals of chromotropic acid, allow the crystals formed to drain and cold dry.

Reaction - The addition of ferric chloride (1 drop) to 10 mL of a 0.1 g/L solution should give a green color.

COMPENDIUM OF INTERNATIONAL METHODS OF ANALYSIS-OIV
Methanol

Sensitivity test - Dilute 0.5 mL of analytical grade formaldehyde to 1 L with water. To 5 mL of 0.05%chromotropic acid solution in sulfuric acid, 75% (v/v), add 0.1 mL of formaldehyde solution and heat to 70°C for 20 min. A violet color should be produced.

2.1.2 Chromotropic acid solution, 0.05%, in sulfuric acid solution, 75% (v/v).

Dissolve 50 mg chromotropic acid (2.1.1) or its sodium salt in 35 mL of distilled water. Cool this solution with iced water and add carefully 75 mL of concentrated sulfuric acid ($\rho_{20}=1.84$ g/mL) in small portions, while mixing.

This solution must be prepared just before use.

2.1.3 Methanol, 5 g/L, standard solution in alcohol 5%, (v/v)

Pure methanol ($E_{760} = 64.7 \pm 0.2$)	0.5 g
Absolute alcohol (without methanol)	50 mL
Distilled water to	1 liter

2.1.4 Dilution solution

Absolute alcohol (without methanol)	50 mL
Distilled water to	1 liter

2.1.5 Phosphoric acid solution, 50% (m/v)

2.1.6 Potassium permanganate solution, 5% (m/v)

2.1.7 Neutral sodium sulfite solution, 2% (m/v)

Solution rapidly oxidizes in air. Determine the exact strength by iodometric titration.

2.2 Procedure

Dilute the wine distillate (see chapter *Alcoholic strength*) to reduce the alcoholic strength to 5% vol.

Into a ground-glass stopper test tube place 0.5 mL of the diluted distillate, add 1 drop of phosphoric acid, 50%, 2 drops

COMPENDIUM OF INTERNATIONAL METHODS OF ANALYSIS-OIV
Methanol

of potassium permanganate solution, 5%, shake and allow to stand for 10 minutes.

Decolorize the permanganate by adding a few drops, usually 4, of neutralized 2% sodium sulfite solution, (avoid any excess). Add 5 mL 0.05% chromotropic acid. Place in a water bath at 70°C for 20 min. Allow to cool.

Determine the absorbance A_s , at 570 nm, the zero of the absorbance being adjusted on the control sample prepared with 0.5 mL of the dilution solution.

Calibration curve

In a series of 50 mL volumetric spherical flasks, place 2.5, 5, 10, 15, 20, 25 mL respectively of the methanol, 0.5 g/L, solution in ethanol 5%. Make up to volume with a 5% ethanol solution. These solutions contain 25, 50, 100, 150, 200 and 250 mg of methanol per liter.

Treat simultaneously 0.5 mL of the dilution solution and 0.5 mL of each of the standard solutions, with the same technique as used to bring the wine distillate to an ethanol concentration of 5%.

Determine the absorbance of these solutions at 570 nm, in the conditions described above.

The graph of absorbance of the standard solutions as a function of concentration should be a straight line.

2.3 Calculations

Determine the methanol concentration, expressed in mg/L of the wine distillate brought to an alcoholic strength of 5% vol., and plotted as A_s on the calibration line.

Express the concentration in wine in mg/L taking into account the dilution performed to bring the strength to 5% vol.

Glycerol and 2,3-Butanediol

(Resolution OIV/OENO 377/2009)

1. Principle

Glycerol and 2,3-butanediol are oxidized by periodic acid after treatment through an anion exchange resin column to fix the sugars and a large proportion of mannitol and sorbitol. The product obtained by the action of phloroglucinol on formaldehyde (by glycerol oxidation) is determined colorimetrically at 480 nm. The product formed by the action of piperidine solution and sodium nitroferricyanide solution with the ethanol (by oxidation of 2,3-butanediol) is determined colorimetrically at 570 nm.

2. Apparatus

- 2.1 Glass column 300 mm long and approximately 10-11 mm internal diameter fitted with a stopcock.
- 2.2 Spectrophotometer allowing measurement to be made between 300 and 700 nm and glass cells with optical path length of 1 cm.

3. Reagents

- 3.1 Glycerol, $C_3H_8O_3$
- 3.2 2,3-Butanediol, $C_4H_{10}O_2$
- 3.3 A strongly basic anion exchange resin e.g. anion exchange resin of Merck strength III or Amberlite IRA 400.
- 3.4 Polyvinylpolypyrrolidone (PVPP) (see *International Oenological Codex*).
- 3.5 Periodic acid, 0.1 M, in sulfuric acid, 0.05 M.
Weigh 10.696 g of sodium periodate, $NaIO_4$, place into a 500 mL volumetric flask, dissolve with 50 mL of sulfuric acid, 0.5 M, and make up to 500 mL with distilled water.
- 3.6 Periodic acid, 0.05 M, in sulfuric acid, 0.025 M.
The above solution (3.5) is diluted 1 : 1 with distilled water.
- 3.7 Sulfuric acid, 0.5 M.
- 3.8 Sodium hydroxide solution, 1 M.
- 3.9 Sodium hydroxide solution, 5% (m/v).

**COMPENDIUM OF INTERNATIONAL METHODS OF ANALYSIS -
OIV**

Glycerol and 2,3-Butanediol

- 3.10 Ethanol, 96% (v/v).
- 3.11 Phloroglucinol solution, 2% (m/v), to be prepared fresh daily.
- 3.12 Sodium acetate solution, 27% (m/v), prepared from anhydrous sodium acetate, CH₃COONa.
- 3.13 Sodium nitroferricyanide solution, Na₂Fe(CN)₅NO.2H₂O, 2% (m/v), to be prepared fresh daily
- 3.14 Piperidine solution, C₅H₁₁N 25% (v/v), to be prepared fresh daily.
- 3.15 Standard glycerol solution
Prepare a solution containing 250 g glycerol in 100 mL and determine the glycerol content by the enzymatic or periodimetric method (see section 6).
Prepare the standard glycerol solution as follows: weigh in a 100 mL volumetric flask a mass "m" corresponding to 250 mg of pure glycerol, make up to 100 mL with water.
- 3.16 Standard 2,3-butanediol solution
Prepare a solution containing 250 mg of 2,3-butanediol sample in 100 mL and determine the 2,3-butanediol content by the periodimetric method (see section 6).
Prepare the standard solution of 2,3-butanediol by weighing in a 100 mL volumetric flask a mass "m" corresponding to 250 mg of pure 2,3-butanediol; make up to 100 mL with water.
- 3.17 Alkaline copper solution:
Copper Solution A
Copper sulfate, CuSO₄.5H₂O 40 g
Sulfuric acid (r=1.84 g/mL) 2 mL
Make up to 1000 mL with water
Alkaline tartaric solution B
Potassium sodium tartrate tetrahydrate
KNaC₄H₄O₆.4H₂O 200 g
Sodium hydroxide 150 g
Make up to 1000 mL with water
The copper alkaline solution is obtained by mixing solution A and B in equal quantities at the time of use.

4. Procedure

- 4.1 *Preparation of an anion exchange column*

**COMPENDIUM OF INTERNATIONAL METHODS OF ANALYSIS -
OIV
Glycerol and 2,3-Butanediol**

The anion exchange resin (Cl⁻) must be kept in a flask filled with decarbonated distilled water.

Put 30 mL of anion exchange resin (3.3) in the column (2.1), place a wool plug on the top of the column to stop air contact with the resin. Pass 150 mL of 5% sodium hydroxide (3.9) through the column at a flow rate of 3.5 to 5 mL per minute followed by a similar quantity of decarbonated distilled water at the same flow rate until the eluent is neutral or slightly alkaline to phenolphthalein. The resin is then ready for use.

The anion exchange resin can only be used once. It can be regenerated by treating with 5% hydrochloric acid for a few hours and then rinsed with water until free of chloride. (Check for absence of chloride).

4.2 *Preparation of sample*

The wine sample is diluted 10/50.

In case of strongly colored wines, first decolorize with PVPP (3.4): place 10 mL wine in a 50 mL volumetric flask, dilute with water (20 mL) and add 300 mg of PVPP (3.4). Leave for 20 min. stirring occasionally, make to the mark and filter through fluted filter paper. Take 10 mL of diluted wine (treated or untreated with PVPP) and place on the anion exchange column. Allow to drain, drop by drop, at flow rate not exceeding 2 mL per minute. When the level of diluted wine reaches 5-10 mm above the glass wool plug, add decarbonated distilled water to bring the volume of the eluent to 100 mL at a flow rate 2-3 mL per minute. The eluate must be free of sugars. To ensure this, boil rapidly 5 mL of eluate with 5 mL of alkaline copper solution (3.17). There should not be any discoloration or precipitation.

4.3 *Determination of glycerol*

4.3.1 Photometric determination

Place into a 100 mL conical ground necked vessel:

10 mL eluate and add successively

10 mL distilled water and

10 mL periodic acid solution, 0.05 M (3.6).

Stir carefully; leave exactly 5 min. for the oxidation to take place. Add 10 mL sodium hydroxide solution, (3.8), and 5 mL 96% ethanol (v/v) (3.10).

**COMPENDIUM OF INTERNATIONAL METHODS OF ANALYSIS -
OIV
Glycerol and 2,3-Butanediol**

Stir after each addition, then add 10 mL phloroglucinol solution (3.11)

Mix rapidly and transfer the solution into a 1 cm cell. The purple coloration is obtained very quickly. Its intensity reaches a maximum after 50 to 60 seconds, then decreases. Note the maximal absorbance. The measurement is carried out at 480 nm using air as a reference.

4.3.2 Preparation of the calibration curve

Pipette into 100 mL volumetric flasks:

3.0, 4.0, 5.0, 6.0, 7.0 and 8.0 mL glycerol standard solution (3.15) and make up to volume with distilled water.

These solutions correspond, according to the conditions in 4.2, to the following concentrations:

3.75, 5.00, 6.25, 7.50, 8.75 and 10.00 g/L of glycerol.

Proceed with the determination as described in 4.3.1, replacing the eluate by the same volume of each of the standard solutions.

4.4 *Determination of 2,3-butanediol*

4.4.1 Photometric determination

Place into a conical 100 mL ground stoppered vessel:

20 mL eluate and add successively

5 mL sodium acetate solution (3.12) and

5 mL 0.1 M periodic acid solution (3.5).

Stir to mix, leave for 2 min exactly for oxidation to take place

Add:

5 mL sodium nitroferricyanide solution (3.13) and

5 mL piperidine solution (3.14).

Transfer the solution into a 1 cm cell. The purple color is obtained very rapidly; its intensity reaches a maximum after 30-40 sec then diminishes. Note the maximal absorbance. The measurement is carried out at 570 nm using air as a reference.

4.4.2 Preparation of the calibration curve

Put 10.0 mL of 2,3-butanediol standard solution (3.16) in a 100 mL volumetric flask and make up with distilled water. From this solution prepare standard solutions by pipetting respectively into 100 mL volumetric flasks:

2.0, 4.0, 6.0, 8.0 and 10.0 mL, make up with distilled water

**COMPENDIUM OF INTERNATIONAL METHODS OF ANALYSIS -
OIV
Glycerol and 2,3-Butanediol**

These solutions correspond, according to the conditions described in 4.2 to the following concentrations: 0.25, 0.50, 0.74, 1.00 and 1.25 g/L of 2,3-butanediol.

Proceed with the determination as described in 4.4.1, replacing the eluate by the same volume of each of the standard solutions. The straight line of the calibration graph should pass through the origin.

5. Calculation and expression of results

5.1 *Glycerol*

5.1.1 Method of calculation

Read the glycerol content from the calibration curve. The result is expressed in g/L to one decimal place.

5.1.2 Repeatability

5.1.3 Reproducibility

5.2 *2,3-Butanediol*

5.2.1 Method of calculation

Read the 2,3-butanediol content on the calibration. The result is expressed in g/L to two decimal places.

5.2.2 Repeatability

5.2.3 Reproducibility

6. Glycerol and 2,3-butanediol by periodimetric titration

6.1 *Reagents*

6.1.1 Sodium hydroxide solution, 1 M.

6.1.2 Sulfuric acid solution, 0.5 M.

6.1.3 Periodic acid solution, 0.025 M.

6.1.4 Sodium bicarbonate solution, NaHCO₃, 8% (*m/v*).

6.1.5 Sodium arsenate solution, 0.025 M.

In a 1000 mL volumetric flask, dissolve 2.473 g of arsenic III oxide, As₂O₃, with 30 mL 1 M sodium hydroxide, (6.1.1) add 35 mL 0.5 M sulfuric acid (6.1.2), and make up to the mark with distilled water.

6.1.6 Iodine solution, 0.025 M.

**COMPENDIUM OF INTERNATIONAL METHODS OF ANALYSIS -
OIV**

Glycerol and 2,3-Butanediol

6.1.7 Potassium iodide, 10% (m/v).

6.1.8 Starch paste, 2% (m/v).

6.2 Procedure

In a 300 mL conical flask add:

5 mL glycerol sample solution (3.15)

45 mL distilled water

or

25 mL 2,3-butanediol sample solution (3.16)

25 mL distilled water

Add:

20 mL periodic acid, 0.025 M (6.1.3), leave for 15 min,
shaking from time to time

10-20 mL sodium bicarbonate solution (6.1.4)

20 mL sodium arsenate solution (6.1.5)

Leave for 15 min shaking from time to time and add:

5 mL potassium iodide solution (6.1.7)

2 mL starch paste (6.1.8)

Titrate the excess sodium arsenate with 0.025 M iodine
solution (6.1.6).

Prepare at the same time a blank test using 50 mL distilled
water and the same quantity of reagents.

6.3 Method of calculation

6.3.1 Glycerol

1 mL periodic acid, 0.025 M, oxidizes 1.151 mg glycerol.

The glycerol content in g/L of the glycerol standard solution
(3.15) is:

$$G = \frac{(X-B) \times 1,151}{\alpha}$$

The percentage of glycerol used in the standard
glycerol solution (3.15) is:

$$\frac{G}{2,5} \times 100$$

X = mL of the iodine solution, 0.025 M,
used up by the standard solution (3.15)

B = mL of the iodine solution, 0.025 M, in the blank test

a = mL of the solution test (3.15) (equal to 5 mL)

6.3.2 2,3-Butanediol

**COMPENDIUM OF INTERNATIONAL METHODS OF ANALYSIS -
OIV**

Glycerol and 2,3-Butanediol

1 mL periodic acid, 0.025 M, oxidizes 2.253 mg of 2,3-butanediol.

The 2,3-butanediol content in g/L of the 2,3-butanediol standard solution (3.16) is:

$$BD = \frac{(X' - B') \times 2,253}{b}$$

The percentage of 2,3-butanediol used in the 2,3-butanediol standard solution (3.2) is:

$$\frac{BD}{2,5} \times 100$$

X' = mL of iodine solution, 0.025 M, used up by the standard solution (3.16)

B' = mL of iodine solution, 0.025 M, used in blank test

b = mL of the solution test (3.16) (equal to 25 mL)

BIBLIOGRAPHY

REBELEIN H., *Z. Lebensm. Unters. u. Forsch.*, 1957, **4**, 296, *F.V.*, *O.I.V.*, n° 63.

TERCERO C., SANCHEZ O., *F.V.*, *O.I.V.*, 1977, n° 651 et 1981, n° 731.

Glycerol

(Recueil OIV ed. 1990 revised by OIV/OENO 377/2009)

1 Principle

The glycerokinase (GK) catalyses the phosphorylation of glycerol to glycerol-3-phosphate by adenosine-5'-triphosphate (ATP) (1):



The adenosine-5'-diphosphate (ADP) is then converted into ATP by phosphoenol-pyruvate (PEP) in presence of pyruvate-kinase (PK) with pyruvate (2) formation:



Pyruvate is converted into lactate by reduced nicotinamide-adenine dinucleotide (NADH) in presence of lactate-dehydrogenase (LDH) (3):

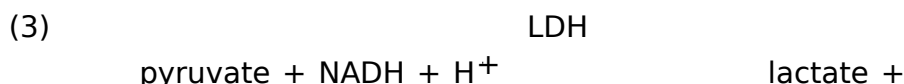

The quantity of NAD^+ formed during the reaction is proportional to the quantity of glycerol. The NADH oxidization is measured by the decrease of its extinction at wavelengths of 334 nm, 340 nm or 365 nm.

2. Apparatus

2.1 Spectrophotometer enabling measurements to be made at 340 nm, at which absorption by NADH is at a maximum.

If not available, a photometer using a source with a discontinuous spectrum enabling measurements to be made at 334 nm or at 365 nm, may be used.

2.2 Glass cells of 1 cm optical path length or single-use cells.

2.3 Micropipettes enabling the selection of volumes from 0.02 to 2 mL.

**COMPENDIUM OF INTERNATIONAL METHODS OF ANALYSIS -
OIV
Glycerol**

3. Reagents

3.1 Buffer solution (0.75 M glycylglycine, $Mg^{2+} 10^{-3} M$, pH = 7.4)
Dissolve 10.0 g of glycylglycine and 0.25 g of magnesium sulfate ($MgSO_4 \cdot 7 H_2O$) in about 80 mL of double distilled water, add about 2.4 mL of 5 M sodium hydroxide solution to obtain a pH of 7.4 and make up to 100 mL. This buffer solution may be kept for 3 months at + 4°C.

3.2 (NADH $8.2 \cdot 10^{-3} M$, ATP $33 \cdot 10^{-3} M$, PEP $46 \cdot 10^{-3} M$)

Dissolve:

42 mg of nicotinamide-adenine-dinucleotide reduced - Na_2
120 mg of adenosine-5'-triphosphate, Na_2H_2
60 mg of phosphoenol pyruvate, Na and
300 mg of sodium bicarbonate ($NaHCO_3$)
in 6 mL of double distilled water.

This may be kept for 2-3 days at + 4°C.

3.3 Pyruvate-kinase/lactate-dehydrogenase (PK/LDH)

(PK 3 mg /mL, LDH 1 mg /mL)

Use the suspension without diluting it.

This may be kept for a year at about + 4°C.

3.4 Glycerokinase (GK 1 mg/mL)

The suspension may be kept for a year at about + 4°C.

Note: All reagents needed for the above are available commercially.

4. Preparation of sample

The determination of glycerol is generally made directly on the wine, which is diluted with double distilled water so that the resulting glycerol concentration is between 30 and 500 mg/L. Wine diluted 2 /100 is usually sufficient.

5. Procedure

With spectrophotometer adjusted to 340 nm wavelength the absorbance measurements are made in the glass cells with optical path length of 1 cm, with air as a reference.

Into cells with 1 cm optical paths place the following:

cell	Reference cell	Sample
Solution 3.1	1.00 MI	1.00 mL

**COMPENDIUM OF INTERNATIONAL METHODS OF ANALYSIS -
OIV
Glycerol**

Solution 3.2	0.10 mL	0.10 mL
Sample to be measured	-	0.10 mL
Water	2.00 mL	1.90 mL
Suspension 3.3	0.01 mL	0.01 mL

Mix, and after about 5 min, read the absorbances (A_1). Start the reaction by adding:

Suspension 3.4	0.01 mL	0.01 mL
----------------------	---------	---------

Mix, wait until the end of the reaction (5 to 10 min), read the absorbance of the solutions (A_2). Read the absorbance after 10 min and check every 2 min until the absorbance is constant for 2 min.

Calculate the differences in the absorbance:

$$A_2 - A_1$$

for the reference and sample cells.

Calculate the differences in absorbance between the reference cell (ΔA_T) and the sample cell (ΔA_D) using the equation:

$$\Delta A = \Delta A_D - \Delta A_T$$

6. Expression of results

6.1 Calculation

The general formula for calculating the concentration is:

$$C = \frac{V \times PM}{\varepsilon \times d \times v \times 1000} \times \Delta A$$

V = volume of the test in mL (3.12 mL)

v = volume of the sample mL (0.1 mL)

PM = molecular weight of the substance to be determined (glycerol = 92.1)

d = optical path length of the cell (1 cm)

ε = absorption coefficient of NADH at 340 nm

$$\varepsilon = 6.3 \text{ (mmol}^{-1} \times l \times \text{cm}^{-1}\text{)}$$

When using the amounts given in brackets this reduces to:

$$C = 0.456 \times \Delta A \times F$$

F = dilution factor

Note:

— Measurement at 334 nm, $\varepsilon = 6.2 \text{ (mmol}^{-1} \times l \times \text{cm}^{-1}\text{)}$

$$C = 0.463 \times \Delta A \times F$$

— Measurement at 365 nm, $\varepsilon = 3.4 \text{ (mmol}^{-1} \times l \times \text{cm}^{-1}\text{)}$

**COMPENDIUM OF INTERNATIONAL METHODS OF ANALYSIS -
OIV
Glycerol**

$$C = 0.845 \times \Delta A \times F$$

BIBLIOGRAPHY

BOERHINGER, Mannheim, *Methods of Enzymatic and chemical analysis*, documentation technique.

Method OIV-MA-AS312-06

Type II method

**Determination by isotope ratio mass spectrometry $^{13}\text{C}/^{12}\text{C}$ of
wine ethanol or that obtained through the fermentation of
musts, concentrated musts or grape sugar.**

(Resolution OENO 17/2001)

1. FIELD OF APPLICATION

The method enables the measuring of isotope ratio $^{13}\text{C}/^{12}\text{C}$ of ethanol in wine and ethanol obtained after fermentation of products derived from the vine (musts, concentrated musts, grape sugar).

2. REFERENCE STANDARDS

ISO 5725 :1994 «Accuracy (trueness and precision) of measurement methods and results: Basic method for the determination of repeatability and reproducibility of a standard measurement method»

V-PDB : Vienna-Pee-Dee Belemnite ($R_{\text{PDB}} = 0.0112372$).

Method OIV «Detection of enriching musts, concentrated musts, grape sugar and wine by application of nuclear magnetic deuterium resonance (RMN-FINS): »

3. TERMS AND DEFINITIONS

$^{13}\text{C}/^{12}\text{C}$: Carbon 13 and carbon 12 isotope ratio for a given sample

$\delta^{13}\text{C}$: Carbon 13 contents (^{13}C) expressed in parts per 1000 (‰)

RMN-FINS : Fractioning the specific natural isotope studied by nuclear magnetic resonance

V-PDB : Vienna-Pee-Dee Belemnite. or PDB, is the main reference for measuring natural variations of carbon 13 isotopic contents. Calcium carbonate comes from a Cretaceous belemnite from the Pee Dee formation in South Carolina (USA). Its isotopic ratio $^{13}\text{C}/^{12}\text{C}$ or R_{PDB}

is $R_{\text{PDB}} = 0.0112372$. PDB reserves have been exhausted for a long time, but it has natural variations of Carbon 13 isotopic contents. Reference material is calibrated based on this content and is available at the International Agency of Atomic Energy (IAEA) in Vienna (Austria). The isotopic indications of naturally occurring carbon 13 are expressed by V-PDB, as is the custom.

m/z: Mass to charge ratio

4. PRINCIPLE

During photosynthesis, the assimilation of carbonic gas by plants occurs according to 2 principle types of metabolism that are: metabolism C₃ (Calvin cycle) and C₄ (Hatch and Slack). These two means of photosynthesis present a different type of isotope fractionation. Products, such as sugars and alcohol, derived from C₄ plants and fermentation, have higher levels of Carbon 13 than from C₃ plants. Most plants, such as vines and sugar beets belong to the C₃ group. Sugar cane and corn belong to the group C₄. Measuring the carbon 13 content enables the detection and the quantification of C₄ (sugar cane or corn isoglucose) origin sugars which are added to products derived from grapes (grape musts, wines). The combined information on carbon 13 content and information obtained from RMN-FINS enable the quantification of mixed sugars added or alcohol of plant origin C₃ and C₄.

The carbon 13 content is determined by carbonic gas resulting from the complete combustion of the sample. The abundance of main mass isotopomers 44 (¹²C¹⁶O₂), 45 (¹³C¹⁶O₂ et ¹²C¹⁷O¹⁶O) and 46 (¹²C¹⁶O¹⁸O), resulting from different possible combinations of isotopes ¹⁸O, ¹⁷O, ¹⁶O, ¹³C et ¹²C, are determined from ionic currents measured by three different collectors of mass isotopic spectrometers. The contributions of isotopomers ¹³C¹⁷O¹⁶O et ¹²C¹⁷O₂ are sometimes neglected because of their small presence. The ionic current for m/z = 45 is corrected for the contribution of ¹²C¹⁷O¹⁶O which is calculated according to the current intensity measured for m/z = 46 while considering the relative abundance of ¹⁸O et ¹⁷O (Craig adjustment). The comparison with the calibrated reference and the international reference V-PDB enable the calculation of carbon 13 content on a relative scale of δ¹³C.

5. REAGENTS

The material and the consumables depend on the apparatus (6) used by the laboratory. The systems generally used are based on elementary analysers. These systems can be equipped to introduce the samples placed in sealed metal capsules or for the injection of liquid samples through a septum using a syringe.

Depending on the type of instrument used, the reference material, reagents, and consumables can be used:

COMPENDIUM OF INTERNATIONAL METHODS OF ANALYSIS - OIV
Ethanol

- Reference material

available from the IAEA:

Name	Material	$\delta^{13}\text{C}$ versus V-PDB (9)
- IAEA-CH-6	saccharose	-10.4 ‰
-IAEA-CH-7	polyethylene	-31.8 ‰
- NBS22	oil	-29.7 ‰
- USGS24	graphite	-16.1 ‰

available from the IRMM de Geel (B) (Institut des Matériaux et Mesures de Référence) :

Name	Material	$\delta^{13}\text{C}$ versus V-PDB (9)
- CRM 656	Wine alcohol	-26.93 ‰
- CRM 657	glucose	-10.75 ‰
- CRM 660	hydroalcoholic solution (TAV 12%)	-26.72 ‰

Standard work sample with a known calibrated $^{13}\text{C}/^{12}\text{C}$ ratio with international reference materials.

A standard list of consumables established for continuous flow systems follows here under :

- Helium for analysis (CAS 07440-59-7)
 - Oxygen for analysis (CAS 07782-44-7)
 - Carbon dioxide for analysis, used as a secondary reference gas for the content of carbon
13 (CAS 00124-38-9)
 - Oxidation reagent for the oven and the combustion system as follows:
copper oxide (II) for elementary analyzed (CAS 1317-38-0)
 - Drying agent to eliminate water produced by combustion. For example:
anhydron for elementary analysis (magnesium perchlorate) (CAS 10034-81-8).
- This is not necessary for apparatuses equipped with a water elimination system by cryo-trapping or through selective permeable capillaries.*

6. APPARATUS AND MATERIAL

6.1. Isotope ratio mass spectrometry (IRMS)

Isotope ratio mass spectrometry (IRMS) enables the determination the relative contents of ^{13}C of CO_2 gas naturally occurring with an internal accuracy of 0.05‰ or expressed in relative value (9). Internal accuracy here is defined as the difference between 2 measurements of the same sample of CO_2 . The mass spectrometer used to measure isotope ratios is generally equipped with a triple collector to simultaneously measure $m/z = 44, 45$ and 46 intensities. The isotope ratio mass spectrometry must either be equipped with a double introduction system to alternately measure the unknown sample and a reference sample, or use an integrated system that carries out quantitative combustion on samples and separates the carbon dioxide from the other combustion products before measuring the mass spectrum.

6.2. Combustion apparatus

Combustion apparatus able to quantitatively convert ethanol in carbon dioxide and able of eliminating all other combustion products including water, without any isotopic fractioning. The apparatus can be either an integrated continual flow system integrated with mass spectrometry (6.2.1), of an autonomous combustion system (6.2.2). The apparatus must be as precise as indicated in (11).

6.2.1. Continual flow system

These are made up by an elementary analyser, either by chromatography in gaseous state equipped with an online combustion system.

The following laboratory material is used for systems equipped for the introduction of samples contained in metallic capsules :

- volumetric micropipette with appropriate cones
- scale with μg accuracy or better
- pliers for encapsulation
- tin capsules for liquid samples
- tin capsules for solid samples

The following laboratory material is needed when using an elementary analyser equipped with a liquid injector or in the case of a preparation system for combustion chromatography:

- syringe for liquids
- flasks equipped with sealed closing system and inert septa

The laboratory material indicated in the lists are examples that are susceptible of being replaced by other equivalent performance material depending on the type of combustion apparatus and of mass spectrometry used by the laboratory.

6.2.2 Autonomous preparation system

The samples of carbon dioxide resulting from the combustion of samples to be analyzed and the reference sample are collected in bulbs which are then put in a double entry spectrometry system to carry out isotopic analyses. Several combustion apparatuses described in writings can be used:

- Closed combustion system filled with oxygen gas circulating
- Elementary analyser with helium and oxygen flow
- Bulb sealed in glass filled with copper oxide (II) used as an oxidation agent

7. PREPARATION OF SAMPLES FOR TRIALS

Ethanol must be extracted from wine before isotopic testing. This is carried out by distilling wine as described in §3.1 using the RMN-FINS method.

Sugars must be fermented in ethanol first as described in the RMN-FINS method in the case of grape musts, concentrated rectified grape musts (grape sugar).

8. PROCEDURE

All preparation steps must be carried out without any significant ethanol loss through evaporation, which would change the isotopic composition of the sample.

The description that follows makes reference to the procedure generally used for ethanol sample combustion using commercial automatic combustion systems. All other methods, ensuring that ethanol samples are converted by quantity in carbon dioxide without the evaporation of ethanol, can use the preparation of carbon dioxide for isotopic analyses. An experimental procedure based on the usage of an elementary analyser:

a) Placing the samples in capsules

- use capsules, a tweezers and a clean preparation tray
- take an appropriate sized capsule using a tweezers
- introduce an appropriate amount of liquid into the capsule using a micropipette

Note: 3.84 mg of absolute ethanol or 4.17 mg of distillate with an alcohol content of 92% m/m are necessary to obtain 2 mg of carbon. The appropriate quantity of distillate must be calculated in the same way according to the quantity of carbon necessary based on the mass spectrometry instruments' sensitivity.

- close the capsule with the tweezers.
- each capsule must be completely sealed. If not, it must be discarded and the capsule must be repaired.
- two capsules must be prepared for every sample
- place the capsules in an appropriate place on the tray elementary analyser sample. Every capsule must be carefully identified in order by number .
- systematically place capsules containing work references at the beginning and the end of the sample series
- regularly insert a check sample in the sample series.

b) check and adjust the elementary analysis and mass spectrometry instruments

- adjust the temperature of the elementary analyzer ovens and the helium and oxygen gas flow for an optimal combustion of the sample;
- check the elementary analysis system and the mass spectrometry system for leaks (for example by checking the ionic current where $m/z = 28$ corresponding to N_2);
- adjust the mass spectrometer to measure the intensities of ionic current where $m/z = 44, 45$ and 46 ;
- check the system using known reference samples before starting to measure the samples.

c) To carry out a series of measurements

The samples that are placed under the elementary or chromatography are introduced successively. The carbon dioxide for each sample combustion is eluted towards the mass spectrometer which measures the ionic current. The interface computer records the ionic current intensities and calculates the values δ for each sample (9).

9. CALCULATION

The objective of the method is to measure the isotopic ratio $^{13}C/^{12}C$ ethanol extract from wine or from products derived from grapes following fermentation. The isotopic ratio $^{13}C/^{12}C$ can be expressed by its deviation compared to the reference work. Carbon 13 ($\delta^{13}C$)'s isotopic ratio is calculated on a delta scale per thousand

by comparing the results obtained for the sample to be measured to the reference work calibrated before based on the primary international reference (V-PDB). The values $\delta^{13}\text{C}$ are expressed compared to reference work:

$$\delta^{13}\text{C}_{\text{ech/ref}}\text{‰} = 1000 \times (\text{R}_{\text{ech}} - \text{R}_{\text{ref}}) / \text{R}_{\text{ref}}$$

where R_{ech} and R_{ref} are respectively the isotopic ratio $^{13}\text{C}/^{12}\text{C}$ of the sample and the work reference.

The values $\delta^{13}\text{C}$ are thus expressed using V-PDB:

$$\delta^{13}\text{C}_{\text{ech/V-PDB}}\text{‰} = \delta^{13}\text{C}_{\text{ech/ref}} + \delta^{13}\text{C}_{\text{ref/V-PDB}} + (\delta^{13}\text{C}_{\text{ech/ref}} \times \delta^{13}\text{C}_{\text{ref/V-PDB}}) / 1000$$

where $\delta^{13}\text{C}_{\text{ref/V-PDB}}$ is the isotopic deviation determined beforehand for the work reference to V-PDB.

Small variations may occur while measuring on line due to changes in the instrumental conditions. In this case the $\delta^{13}\text{C}$ samples must be corrected according to the difference in the value $\delta^{13}\text{C}$ from the work reference and the real value, which was calibrated beforehand against V-PDB by comparison with one of the international reference materials. Between two measurements of the reference work, the variation is the correction applied to the sample results that may be assumed to be linear. The reference work must be measured at the beginning and at the end of all sample series. A correction can be calculated for each sample using linear interpolation between two values (the difference between the assigned value of the reference work and the measurements of obtained values).

10. QUALITY INSURANCE AND CONTROL

Check that the value ^{13}C for the reference work does not differ by more than 0.5‰ of the admitted value. If not, the spectrometer instrument adjustments must be checked and possibly readjusted.

For each sample, verify that the difference in result between the 2 capsules measured successively is under 0.3‰. The final result for a given sample is the average value between the 2 capsules. If the deviation is higher than 0.3‰ the measurement should be repeated.

Measurement condition monitoring can be based on the ionic current intensity where $m/z = 44$ and is proportional to the quantity of carbon injected in the

elementary analyzer. Under standard conditions, the ionic current intensity should be almost constant for the samples analysed. A significant deviation could be indicative of ethanol evaporation (an imperfect seal on a capsule), an instability of the elementary analyser or the mass spectrometer.

11. METHOD PERFORMANCE TRAITS (Accuracy)

One joint analysis (11.1) was carried out on distillates containing alcohol of vinous origin and cane and beet alcohol, in addition to different mixtures of these three origins. This study did not take into account the distillation step, further information from other joint laboratory studies on wine (11.2) and namely circuits of aptitude tests (11.3) for isotopic measurements were also considered. The results show that different distillation systems under satisfactory conditions, and in particular those used to measure RMN-FINS, do not have significant varieties for determining $\delta^{13}\text{C}$ of ethanol in wine. The precision parameters observed for wine are almost identical to those obtained in the joint study on distillates (11.1) sur les distillats.

**COMPENDIUM OF INTERNATIONAL METHODS OF ANALYSIS - OIV
Ethanol**

11.1. Joint study on distillates

Year of joint laboratory study: 1996
 Number of laboratories: 20
 Number of samples: 6 samples in double-blind comparison
 Analysis: $\delta^{13}\text{C}$ ethanol

Sample code	Vinous origin alcohol	Beet alcohol	Sugar cane alcohol
A & G	80%	10%	10%
B & C	90%	10%	0%
D & F	0%	100%	0%
E & I	90%	0%	10%
H & K	100%	0%	0%
J & L	0%	0%	100%

Samples	A / G	B / C	D / F	E / I	H / K	J / L
Number of laboratories retained after eliminating aberrant results	19	18	17	19	19	19
Number of results accepted	38	36	34	38	38	38
Average value ($\delta^{13}\text{C}$) ‰	-25.32	-26.75	-27.79	-25.26	-26.63	-12.54
S_r^2	0.0064	0.0077	0.0031	0.0127	0.0069	0.0041
Repeatability standard deviation (S_r) ‰	0.08	0.09	0.06	0.11	0.08	0.06
Repeatability limit r ($2,8 \times S_r$) ‰	0.22	0.25	0.16	0.32	0.23	0.18
S_R^2	0.0389	0.0309	0.0382	0.0459	0.0316	0.0584
Reproductability standard deviation (S_R) ‰	0.20	0.18	0.20	0.21	0.18	0.24
Reproductability limit R ($2,8 \times S_R$) ‰	0.55	0.9	0.55	0.60	0.50	0.68

11.2. Joint laboratory study on two wines and one alcohol

Year of joint laboratory trial: 1996
 Number of laboratories: 14 for distillation of wine and 7 for also measuring $\delta^{13}\text{C}$ of ethanol in wine
 8 for measuring $\delta^{13}\text{C}$ in alcohol sample
 Number of samples: 3 (White wine TAV 9.3% vol., White wine TAV 9.6% Alcohol strength 93% m/m)
 Analysis: $\delta^{13}\text{C}$ of ethanol

Samples	Red wine	White wine	Alcohol
Number of laboratories	7	7	8
Number of accepted results	7	7	8
Average value ($\delta^{13}\text{C}$) ‰	-26.20	-26.20	-25.08
Reproductability variance S_R^2	0.0525	0.0740	0.0962
Reproductability standard deviation (S_R) ‰	0.23	0.27	0.31
Reproductability limit R ($2,8 \times S_R$) ‰	0.64	0.76	0.87

Different distillation systems were used by the participating laboratories. The isotopic indications $\delta^{13}\text{C}$ carried out in one laboratory on the whole number of distillates returned by the participants, does not reveal any absurd values or significant distinct average values. The variation in results ($S^2 = 0.0059$) is comparable to repeatability variances S_r^2 from the joint study on distillates (11.1).

11.3. Results from the exercises of aptitude circuits to isotopic trials

Since December 1994 international aptitude exercises to determine the isotopic measurements for wine and alcohol (TAV distillates 96% vol.) have been regularly organized. The results enable participating laboratories to check the quality of their analyses. Statistical results enable the appreciation of the variety of derterminants

**COMPENDIUM OF INTERNATIONAL METHODS OF ANALYSIS - OIV
Ethanol**

under the reproductability conditions. This enables the estimating the variance parametres and the reproductability limit. The results obtained for the wine and distillate ethanol $\delta^{13}\text{C}$ determents are summarized in the table below:

Date	Wine				Distillates			
	N	S _R	S ² _R	R	N	S _R	S ² _R	R
Dec. 1994	6	0.210	0.044	0.59	6	0.151	0.023	0.42
June 1995	8	0.133	0.018	0.37	8	0.147	0.021	0.41
Dec. 1995	7	0.075	0.006	0.21	8	0.115	0.013	0.32
March 1996	9	0.249	0.062	0.70	11	0.278	0.077	0.78
June 1996	8	0.127	0.016	0.36	8	0.189	0.036	0.53
Sept. 1996	10	0.147	0.022	0.41	11	0.224	0.050	0.63
Dec. 1996	10	0.330	0.109	0.92	9	0.057	0.003	0.16
March 1997	10	0.069	0.005	0.19	8	0.059	0.003	0.16
June 1997	11	0.280	0.079	0.78	11	0.175	0.031	0.49
Sept 1997	12	0.237	0.056	0.66	11	0.203	0.041	0.57
Dec. 1997	11	0.127	0.016	0.36	12	0.156	0.024	0.44
March 1998	12	0.285	0.081	0.80	13	0.245	0.060	0.69
June 1998	12	0.182	0.033	0.51	12	0.263	0.069	0.74
Sept 1998	11	0.264	0.070	0.74	12	0.327	0.107	0.91
Weighted average		0.215	0.046	0.60		0.209	0.044	0.59

N : number of participating laboratories

12. BIBLIOGRAPHY

Detecting enrichment of musts, concentrated musts, grape and wine sugars by application of nuclear magnetic resonance of deuterium (RMN-FINS/SNIF-NMR)
OIV Recueil des méthodes internationales d'analyse des vins et des moûts.

E.C. Regulation. Community analytical methods which can be applied in the wine sector, N°.2676/90. Detecting enrichment of grape musts, concentrated grape musts, rectified concentrated grape musts and wines by application of nuclear magnetic resonance of deuterium (SNIF-NMR)

Official Journal of the European Communities, N°L 272, Vol 33, 64-73, 3 October 1990.

Inter-laboratory study about the determination of $\delta^{13}\text{C}$ in wine ethanol

OIV FV N° 1051

Fidélité de la détermination du rapport isotopique $^{13}\text{C}/^{12}\text{C}$ de l'éthanol du vin

OIV FV N° 1116.

Stable carbon isotope content in ethanol of EC data bank wines from Italy, France and Germany. A. Rossmann ; H-L. Schmidt ; F. Reniero ; G. Versini ; I. Moussa ; M.-H. Merle. Z. Lebensm. Unters. Forsch., 1996, 203, PP. 293-301.

**COMPENDIUM OF INTERNATIONAL ANALYSIS OF METHODS -
OIV
Glycerol**

Method OIV-AS312-07

Type of the method **IV**

**Method for the determination of the $^{13}\text{C}/^{12}\text{C}$ isotope ratio of
glycerol in wines by Gas Chromatography Combustion or
High performance Liquid Chromatography coupled to
Isotopic Ratio Mass Spectrometry (GC-C-IRMS or HPLC-
IRMS)**

(OIV/OENO 343/2010)

1. SCOPE

The present methods, based on gas chromatography [1] or liquid chromatography [2] coupled to an isotope ratio mass spectrometer (GC-C-IRMS or HPLC-IRMS), permit measurements of the $^{13}\text{C}/^{12}\text{C}$ ratio of glycerol. If its quantification is required simultaneously with the $^{13}\text{C}/^{12}\text{C}$ isotope ratio, GC-IRMS may be used. The use of 1,5-pentanediol, as internal standard, also allows the determination of the glycerol concentration during the same analysis of the $^{13}\text{C}/^{12}\text{C}$ ratio.

2. DEFINITIONS

- $^{13}\text{C}/^{12}\text{C}$: ratio of carbon-13 (^{13}C) to carbon-12 (^{12}C) isotopes for a given sample.
- $\delta^{13}\text{C}$: carbon-13 content (^{13}C) expressed in parts per 1000 (‰, per mil).
- GC-C-IRMS: hyphenated technique of gas chromatography coupled to a combustion interface and isotope ratio mass spectrometry.
- V-PDB: Vienna-Pee-Dee-Belemnite. PDB is the primary reference material for measuring natural variations of carbon-13 isotope content, consisting of calcium carbonate from a Cretaceous belemnite rostrum from the Pee Dee Formation in South Carolina (USA). Its $^{13}\text{C}/^{12}\text{C}$ isotope ratio or R_{PDB} is 0.0112372. PDB reserves have been exhausted for a long time, but it has remained the primary reference for expressing natural variations of carbon-13 isotope content and against which the reference material available at the IAEA (*International Atomic Energy Agency*) in Vienna (Austria) is calibrated. Isotopic indications of naturally occurring carbon-13 are conventionally expressed in relation to V-PDB.

3. PRINCIPLE

A significant difference exists between the carbon-13 content of sugars from plants following the different photosynthetic C₃ (Calvin cycle) and C₄ (Hatch-Slack) cycles. Most plants, such as the vine and beet, belong to the C₃ group, whilst maize and cane belong to the C₄ group. The carbon-13 contents of the sugar and of the corresponding metabolites obtained by fermentation (ethanol, glycerol) are correlated.

The measurement of the carbon-13 content of glycerol may enable possible detection of addition of glycerol from maize (C₄ plant) or from synthesis (fossil sources) to wines or to spirit drinks.

The separation of glycerol from the wine matrix is achieved using gas or liquid chromatography.

In GC-C-IRMS, after the chromatographic separation the effluent undergoes a combustion and a reduction step, passing through the oxidation and the reduction ovens of a combustion interface. Components other than the glycerol, namely the solvent, are vented with a back-flush valve during the run, to avoid oven soiling and interferences in chromatograms. The carbon-13 content is determined on the carbon dioxide gas resulting from the oxidation of the glycerol contained in the sample. Once the glycerol is oxidized, CO₂ and H₂O are produced. Water produced during the combustion is eliminated by a water-removing trap, consisting of a Nafion[®] membrane. The carbon dioxide is eluted by a helium stream to the IRMS source for ¹³C/¹²C analysis.

In HPLC-IRMS, after the chromatographic separation the sample is oxidized while still in the mobile phase at the interface. The CO₂ formed is removed on-line from the solvent stream through a gas-exchange membrane into a stream of He. This He stream passes through a water trap consisting of a Nafion[®] membrane, and is then admitted to the ion source of the IRMS via an open split.

The various possible combinations of the ¹⁸O, ¹⁷O, ¹⁶O and ¹³C, ¹²C, isotopes lead to the mass 44 corresponding to the ¹²C¹⁶O₂ isotopomer, the mass 45 corresponding to ¹³C¹⁶O₂ and ¹²C¹⁷O¹⁶O species and the mass 46 to the ¹²C¹⁶O¹⁸O isotopomer (¹³C¹⁷O¹⁶O and ¹²C¹⁷O₂ can be neglected due to their very low abundance). The corresponding ion currents are determined on three different collectors. The ion current m/z 45 is corrected for the contribution of ¹²C¹⁷O¹⁶O which is computed from the current intensity measured for m/z 46 by considering the relative abundance of ¹⁸O and ¹⁷O (Craig correction). The comparison with a reference calibrated against the international standard V-PDB permits the calculation of the carbon-13 content on the δ¹³C ‰ relative scale.

4. REAGENTS

The following reagents and working standards should be used:

- 4.1 Anhydrous ethanol (CAS number 64-17-5).
- 4.2 Pure glycerol $\geq 99\%$ (CAS 56-81-5).
- 4.3 1,5-pentanediol (CAS 111-29-5).
- 4.4 Bulk solution of 1,5-pentanediol (4.3) in ethanol (4.1). This solution prepared at a precisely known concentration, in the range of 0.5 to 1.0 g L⁻¹ is used to dilute wine samples.
- 4.5 Orthophosphoric acid
- 4.6 Sodium peroxodisulfate, used as oxidation reagent
- 4.7 Helium for analysis, used as carrier gas (CAS 07440-59)
- 4.8 Oxygen for analysis, used as regenerating gas for the combustion reactor (CAS 07782-44-7).
- 4.9 Cylinder of carbon dioxide for analysis, used as a secondary reference gas for the carbon-13 content (CAS 00124-38-9).
- 4.10 Working standard samples of glycerol with a known ¹³C/¹²C ratio calibrated against international reference materials.
- 4.11 Working standard samples of 1,5-pentanediol with a known ¹³C/¹²C ratio calibrated against international reference materials.

5. APPARATUS AND EQUIPMENT

5.1. Isotope ratio mass spectrometer

Isotope ratio mass spectrometer (IRMS) capable of determining the relative ¹³C content of naturally-occurring CO₂ gas with an internal accuracy of 0.05 ‰ or better expressed as a relative value (point 8. Calculation). Internal accuracy here is defined as the difference between two measurements of the same sample of CO₂. The mass spectrometer used to measure isotope ratios is equipped with a triple collector to simultaneously measure intensities for m/z = 44, 45 and 46. The IRMS is equipped with software for running the analysis, acquisition of data and processing of analytical results for computation of isotope ratios.

5.2. Gas chromatograph

**COMPENDIUM OF INTERNATIONAL ANALYSIS OF METHODS -
OIV
Glycerol**

Gas chromatograph (GC) coupled through a combustion interface to an isotope ratio mass spectrometer (5.1).

The gas chromatograph must be equipped with a polar capillary column enabling the chromatographic separation of glycerol from the other wine components (e.g. Chrompack WCOT fused silica capillary column filled with bonded polyethylene glycol CP-Wax-57 CB, 25 m, 0.25 mm id, 0.20 µm film thickness).

Combustion interface generally made up of an oxidation reactor (a ceramic tube containing nickel, platinum and copper wires) and of a reduction reactor (ceramic tube containing copper wires).

5.3. Liquid chromatograph

Liquid chromatograph (LC) coupled through a LC Isolink interface to an isotope ratio mass spectrometer (5.1).

The liquid chromatograph must be equipped with a column enabling the chromatographic separation of glycerol from the other wine components without using organic solvents or additives (e.g. HyperREZ Carbohydrate H⁺, 30 cm, 8 mm).

Isolink interface made up of a capillary oxidation reactor and a membrane exchanger (three membranes).

5.4. Equipment

Usual laboratory equipment and in particular the following:

- Sample injection syringes or autosampler
- Volumetric flasks, 0.2 µm filters, chromatographic vials and 10 µL syringe for liquids.

The laboratory equipment indicated in the above list is an example and may be replaced by other equipment of equivalent performance.

6. PREPARATION OF TEST SAMPLES

6.1. $^{13}\text{C}/^{12}\text{C}$ determination of glycerol by GC-C-IRMS

Each wine sample is filtered on a 0.2 μm filter and then an aliquot is diluted (in the ratio 1:4) with ethanol. Each sample is then transferred to an appropriate chromatographic vial which is then tightly closed and stored at $T \leq 4\text{ }^{\circ}\text{C}$ until analysis.

6.2. $^{13}\text{C}/^{12}\text{C}$ ratio of glycerol and its quantification by GC-C-IRMS

Each wine sample is filtered on a 0.2 μm filter and then an aliquot is diluted (in the ratio 1:4) with the bulk solution of 1,5-pentanediol (4.4). Each sample is then transferred to an appropriate chromatographic vial which is then tightly closed and stored at $T \leq 4\text{ }^{\circ}\text{C}$ until analysis.

6.3. $^{13}\text{C}/^{12}\text{C}$ determination of glycerol by HPLC-IRMS

Each wine sample is filtered on a 0.2 μm filter and then an aliquot is diluted with water. Each sample is then transferred to an appropriate chromatographic vial which is then tightly closed and stored at $T \leq 4\text{ }^{\circ}\text{C}$ until analysis.

7. PROCEDURE

7.1. GC-C-IRMS

The following description refers to the procedures generally used for glycerol $^{13}\text{C}/^{12}\text{C}$ isotope-ratio determination using commercial automated GC-C-IRMS systems.

Procedures may be adapted according to changes introduced by the manufacturers. Note: volumes, temperature, flows and times are indicative. The correct values should be optimized according to the manufacturer's instructions.

7.1.1 Working conditions

Using the column and combustion interface described as an example in 5.2 the following parameters can be applied:

A. The injector temperature is set to 270 °C.

B. The temperature program is set as follows: initial column temperature of 120 °C; a holding time of 2 min; then a temperature increase at a rate of 10 °C min⁻¹, up to the final value of 220 °C, with a final holding time of 2 min.

Each run takes 14 min, not taking into account the time needed for cooling.

C. He is used as the carrier gas.

D. The temperatures of the combustion and reduction reactors of the GC combustion interface are set to 960 and 640°C respectively.

E. In each injection 0.3 µL of sample solution is introduced into the column using a high-split mode (split flow 120 mL min⁻¹).

At regular intervals (e.g. once a week) re-oxidation of the oxidation reactor with O₂ is required (the intervals depend on the total amount of substances that has passed through the reactor).

7.1.2. ¹³C/¹²C ratio of glycerol

During each ¹³C/¹²C analysis, at least two pulses of reference CO₂ gas (4.9) from the cylinder are introduced. This CO₂ is previously calibrated against other V-PDB-calibrated international standards, themselves calibrated against international IAEA standards. The reference CO₂ gas may also be calibrated against in-house standards.

Each wine sample (6.1) is injected 3 times. Suitable control references must be included in each batch.

A typical batch is as follows:

- Control Sample
- Control Sample
- Sample 1
- Sample 1
- Sample 1
- Sample 2

Each sample is measured 3 times

-

- Sample 6
- Sample 6
- Sample 6
- Control sample
- Control sample

The control sample is an ethanol solution of glycerol with a known accurately-measured $\delta^{13}\text{C}$ value (by an elemental analyser-IRMS for instance) and enables possible drift during the sequence of measurements to be checked and the correction of results.

7.1.3 $^{13}\text{C}/^{12}\text{C}$ ratio of glycerol and its quantification

If quantification of glycerol is required at the same time as $^{13}\text{C}/^{12}\text{C}$ isotope ratio measurement, the previous procedure (7.1.2) is applied to the samples prepared as described in 6.2.

The 1,5-pentanediol (4.3) permits the determination of the concentration of glycerol. Furthermore, $\delta^{13}\text{C}$ values for the internal reference can be used to assess the correctness of the injections and the quality control of the isotopic determinations and of the combustion reaction step.

The concentration of glycerol in wine samples is determined using the internal-standard method. To do this, a calibration curve must be produced, using a constant known concentration for the internal standard, 1,5-pentanediol, and five glycerol solutions at different known concentrations, from 0.50 to 10 g L⁻¹. These solutions are prepared by weighing and dissolving glycerol (4.2) and 1,5-pentanediol in ethanol (4.1), using volumetric flasks. Ensure that the response is linear by successively analysing in triplicate each of the linearity standard solutions containing the internal standard.

7.2. HPLC-IRMS

The following description refers to the procedures generally used for glycerol $^{13}\text{C}/^{12}\text{C}$ isotope ratio determination using commercial automated HPLC-IRMS systems.

Procedures may be adapted according to changes introduced by the manufacturers. Note: volumes, temperature, flows and times are indicative. The correct values should be optimized according to the manufacturer's instructions.

7.2.1 Working conditions

Using the column and interface described as an example in 5.3 the following parameters can be applied:

- A. Flow rate of the eluent is set at 400 $\mu\text{L min}^{-1}$
- B. Flow rate of the acid and oxidant reagents in the LC interface is set at 40 and 30 $\mu\text{L min}^{-1}$, respectively
- C. The temperatures of the interface reactor and the column are set at 99.9 and 65 $^{\circ}\text{C}$, respectively
- D. Helium flow rate of the separation unit is set at 1 $\mu\text{L min}^{-1}$

The reagent bottles are degassed with helium during the complete chromatographic run.

7.2.2. $^{13}\text{C}/^{12}\text{C}$ ratio of glycerol

During each $^{13}\text{C}/^{12}\text{C}$ analysis, at least two pulses of reference CO_2 gas (4.9) from the cylinder are introduced (see example of chromatogram in 11.2). This CO_2 is previously calibrated against other V-PDB-calibrated international standards, themselves calibrated against international IAEA standards. The reference CO_2 gas may also be calibrated against in-house standards.

Each wine sample (6.3) is injected 3 times. Suitable control references must be included in each batch.

A typical batch is as follows:

- Control sample
- Control sample
- Sample 1
- Sample 1
- Sample 1
- Sample 2

Each sample is measured 3 times

-
- Sample 6
- Sample 6
- Sample 6

- Control sample
- Control sample

The control sample is a solution of glycerol with a known accurately measured $\delta^{13}\text{C}$ value (by an elemental analyser-IRMS for instance) and enables possible drift during the sequence of measurements to be checked and the correction of results.

8. CALCULATION

8.1. $^{13}\text{C}/^{12}\text{C}$ ratio

The $^{13}\text{C}/^{12}\text{C}$ isotope ratio can be expressed by its deviation from a working reference.

The isotopic deviation of carbon-13 ($\delta^{13}\text{C}$) is then calculated on a delta scale per thousand ($\delta/1000$ or δ ‰) by comparing the results obtained for the sample to be measured with those for a working reference, previously calibrated on the basis of the primary international reference (V-PDB). During $^{13}\text{C}/^{12}\text{C}$ analyses, a reference CO_2 gas is introduced, which is calibrated against other PDB-calibrated international standards.

The $\delta^{13}\text{C}$ values are expressed in relation to the working reference as follows:

$$\delta^{13}\text{C}_{\text{sample/ref}} \text{‰} = (\text{R}_{\text{sample}}/\text{R}_{\text{ref}} - 1) \times 1000$$

where R_{sample} and R_{ref} are respectively the $^{13}\text{C}/^{12}\text{C}$ isotope ratios of the sample and of the carbon dioxide used as the reference gas (4.9).

The $\delta^{13}\text{C}$ values are expressed in relation to V-PDB as follows:

$$\delta^{13}\text{C}_{\text{sample/V-PDB}} \text{‰} = \delta^{13}\text{C}_{\text{sample/ref}} + \delta^{13}\text{C}_{\text{ref/V-PDB}} + (\delta^{13}\text{C}_{\text{sample/ref}} \times \delta^{13}\text{C}_{\text{ref/V-PDB}})/1000$$

where $\delta^{13}\text{C}_{\text{ref/V-PDB}}$ is the previously determined isotopic deviation of the working reference from V-PDB

Small variations may occur while measuring on-line due to changes in the instrumental conditions. In this case the $\delta^{13}\text{C}$ values of the samples must be corrected according to the difference between the measured $\delta^{13}\text{C}$ value of the standard working sample and its true value, previously calibrated against V-PDB by comparison with one of the international reference materials. Between two measurements of the standard working sample, the variation, and therefore the correction to be applied to the results obtained from the samples, may be assumed to be linear. The standard working sample must be measured at the beginning and at the end of all sample series. A correction can then be calculated for each sample using linear interpolation.

8.2. Glycerol concentration by GC-IRMS

When producing the calibration curve, for each injection, the measured parameter which is taken into account is the area S (in $V*s$) given by the spectrometer. Calculate the ratio R as expressed in equation 1 below, and plot a graph of R versus the concentration ratio of glycerol to the internal standard (IS), C .

A linear plot should be obtained, with a correlation coefficient of at least 0.99.

$$\text{Equation 1} \quad R = \frac{\text{Peak area glycerol}}{\text{Peak area of IS}}$$

Using the analytical conditions described (7.1.1), 1,5-pentanediol being less polar than glycerol shows a retention time of around 310 sec, while that of glycerol is 460 sec ((see example of a chromatogram in 11.1).

The concentration of glycerol in each injection is calculated using the following equation:

$$\text{Equation 2} \quad C_{\text{glyc Sample}} = K \cdot C_{1,5PD \text{ Sample}} \cdot \frac{S_{\text{glyc Sample}}}{S_{1,5PD \text{ Sample}}} \times \text{dilution factor}$$

Where:

$C_{X \text{ Sample}}$ is the concentration in $g L^{-1}$ of the species in the sample;

$S_{X \text{ sample}}$ is the area of the peaks produced;

K (the response factor) is calculated as follows:

$$K = \frac{C_{\text{glyc St}}}{C_{1,5PD \text{ St}}} \cdot \frac{S_{1,5PD \text{ St}}}{S_{\text{glyc St}}} \quad \text{Equation 3 (see 8.2)}$$

The St suffix indicates the concentrations and the areas of 1,5-pentandiol and glycerol in the five standard solutions prepared for the calibration (7.1.3);

Dilution factor: considering the sampling conditions described above (7), the dilution factor is 4.

The concentration value in g L⁻¹ of each sample is the mean of the three injections

9. QUALITY ASSURANCE AND CONTROL

9.1. GC-C-IRMS

For each sample, check that the standard deviation (SD) in three vials measured successively is less than 0.6 ‰. The final result for a given sample is the average value for the three measurements. If the deviation is greater than 06 ‰, the measurement must be repeated.

Checks on correct measurement can be based on the ion current of $m/z = 44$, which is proportional to the quantity of carbon injected into the system. Under standard conditions, the ion current should be almost constant for the samples analysed. A significant deviation could be indicative of imperfect separation and oxidation of glycerol or instability of the mass spectrometer.

9.2. HPLC-IRMS

Check that the ¹³C value for the working reference does not differ by more than 0.5 ‰ from the admissible value. If not, the spectrometer settings should be checked and, if necessary, adjusted.

For each sample, check that the standard deviation (SD) in three vials measured successively is less than 0.6 ‰. The final result for a given sample is the average value for the three measurements. If the deviation is greater than 0.6 ‰, the measurement must be repeated.

**COMPENDIUM OF INTERNATIONAL ANALYSIS OF METHODS -
OIV
Glycerol**

Checks on correct measurement can be based on the ion current of $m/z = 44$, which is proportional to the quantity of carbon injected into the system. Under standard conditions, the ion current should be almost constant for the samples analysed. A significant deviation could be indicative of imperfect separation and oxidation of glycerol or instability of the mass spectrometer.

10. PERFORMANCE CHARACTERISTICS OF THE METHOD

10.1. GC-C-IRMS

10.1.1 Precision

Preliminary studies have been performed on 4 synthetic wine solutions (water-ethanol-glycerol), prepared using glycerol samples of different origins and with a $\delta^{13}\text{C}$ value already determined by EA-IRMS. For the 3 repetitions, $n=3$, using the GC-C-IRMS technique a standard deviation $\text{SD} \leq 0.6 \%$ was considered acceptable.

Precision can be affected by overlapping between 1,5-PD and other wine components or by-products when measuring sweet wines.

10.1.2. Determination of the concentration of glycerol

For the validation of this method, 2 glycerol solutions were used. Assuming that the typical concentration of glycerol is 4 to 10 g L^{-1} in dry wine, the 2 solutions represent this range. The first solution was 4.0 g L^{-1} and gave an experimental concentration of 3.6 g L^{-1} ($\text{SD}=0.2$, $n=8$). The second solution, 8.0 g L^{-1} , gave a value of 7.9 g L^{-1} ($\text{SD}=0.3$, $n=8$).

Furthermore, 5 wine samples (A-E) already analysed for their glycerol concentration using other methods* through the BIPEA proficiency-testing scheme were injected to test the method.

Table 1: Comparison with the concentration of 5 dosed wines.

Sample	A	B	C	D	E
Type	White	Rosé	White	Red	White
Given range	6.2 - 8.4	4.8 - 6.6	5.7 - 7.7	6.3 - 8.5	4.6 - 6.2
Mean value	7.3	5.4	6.7	7.4	5.4
by GC-C-IRMS	6.4	5.4	6.7	7.8	5.4

* BIPEA determinations were performed by HPLC and/or enzymatic analysis. Concentrations are given in g L^{-1} . $n>3$ and $\text{SD} < 0.6$.

The concentrations of glycerol found by GC-C-IRMS are consistent with the values obtained using other analytical techniques such as enzymatic determination or HPLC.

10.2. HPLC-IRMS

Internal validation of HPLC-IRMS method

For the validation of the HPLC-IRMS method, the following samples have been used: a glycerol standard, three synthetic wines (glycerol concentrations ranged within typical concentration found in wines) and a wine.

The precision of the measurement for glycerol was determined by repeating the analysis ten times on each sample, under repeatable conditions, and by performing ten independent analyses on the same sample on three different days, under reproducible conditions (Table 2).

**COMPENDIUM OF INTERNATIONAL ANALYSIS OF METHODS -
OIV
Glycerol**

Table 2. Accuracy and precision of $\delta^{13}\text{C}$ values of glycerol obtained by HPLC-IRMSa

Sample	Repetitions per sample	HPLC-IRMS							
		Day 1		Day 2		Day 3		Precision	
		Mean $\delta^{13}\text{C}$ (‰)	SD (‰)	Mean $\delta^{13}\text{C}$ (‰)	SD (‰)	Mean $\delta^{13}\text{C}$ (‰)	SD (‰)	r (‰)	R (‰)
Glycerol (standard) ^b	10	-27.99	0.05	-27.94	0.04	-27.95	0.08	0.17	0.18
Synthetic wine (6 g/l)	10	-28.06	0.13	-28.14	0.12	-28.14	0.11	0.34	0.35
Synthetic wine (8 g/l)	10	-28.11	0.12	-28.18	0.07	-28.21	0.07	0.25	0.28
Synthetic wine (10 g/l)	10	-28.06	0.06	-28.06	0.09	-28.05	0.09	0.23	0.24
Wine	10	-28.88	0.10	-28.85	0.27	-28.72	0.23	0.60	0.62

^aValues of $\delta^{13}\text{C}$ are expressed in ‰ vs V-PDB

^bEA-IRMS glycerol (standard) result: -28.02 ± 0.09 ‰

The following performance parameters for determining the $\delta^{13}\text{C}$ of glycerol were obtained from a wine sample:

- Repeatability **r: 0,60 ‰**
- Reproducibility **R: 0,62 ‰**

COMPENDIUM OF INTERNATIONAL ANALYSIS OF METHODS - OIV
Glycerol

11. ANNEX

11.1 Typical chromatogram of a GC-C-IRMS analysis of glycerol in wine

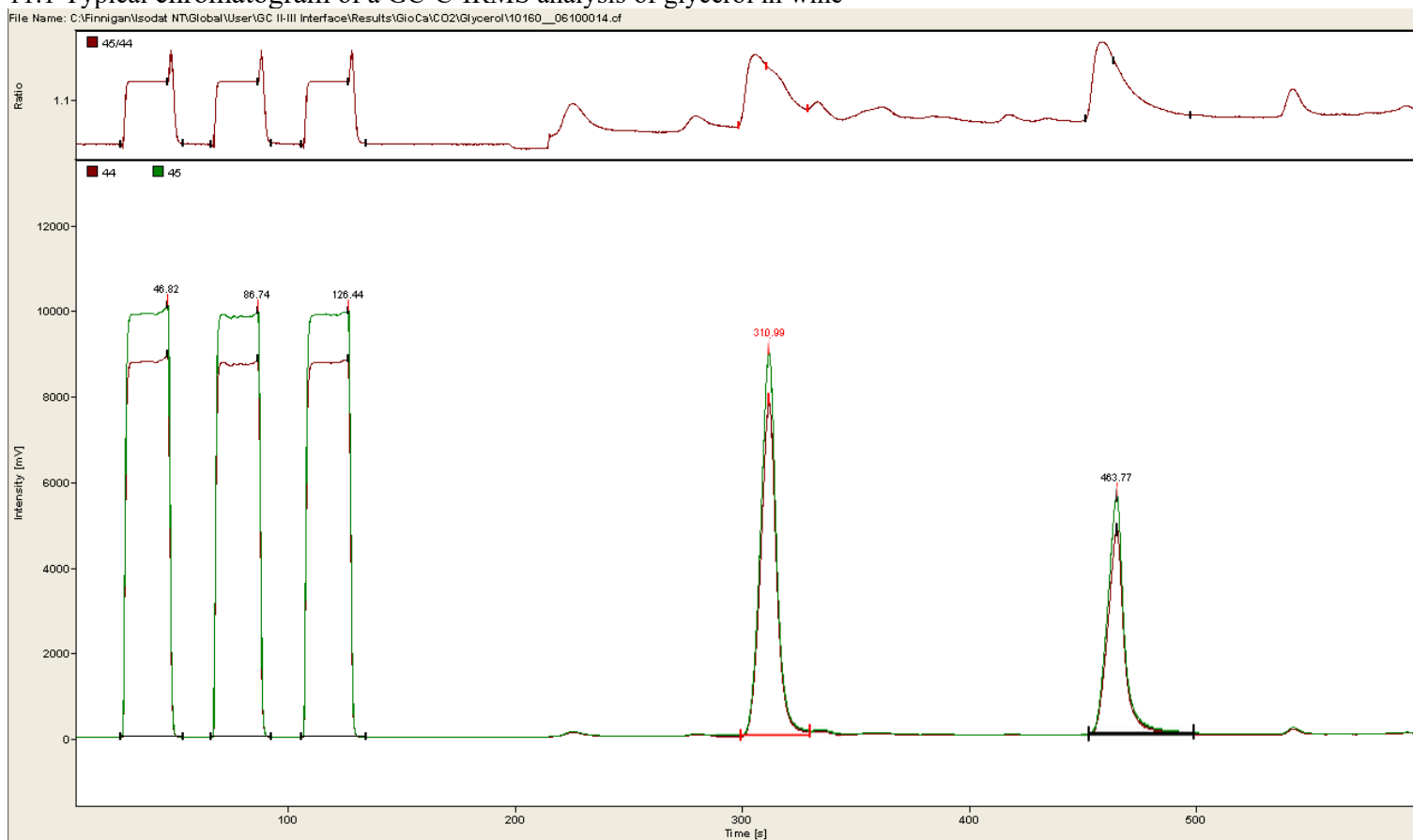

COMPENDIUM OF INTERNATIONAL ANALYSIS OF METHODS - OIV
Glycerol

11.2 Typical chromatogram of a HPLC-IRMS analysis of glycerol

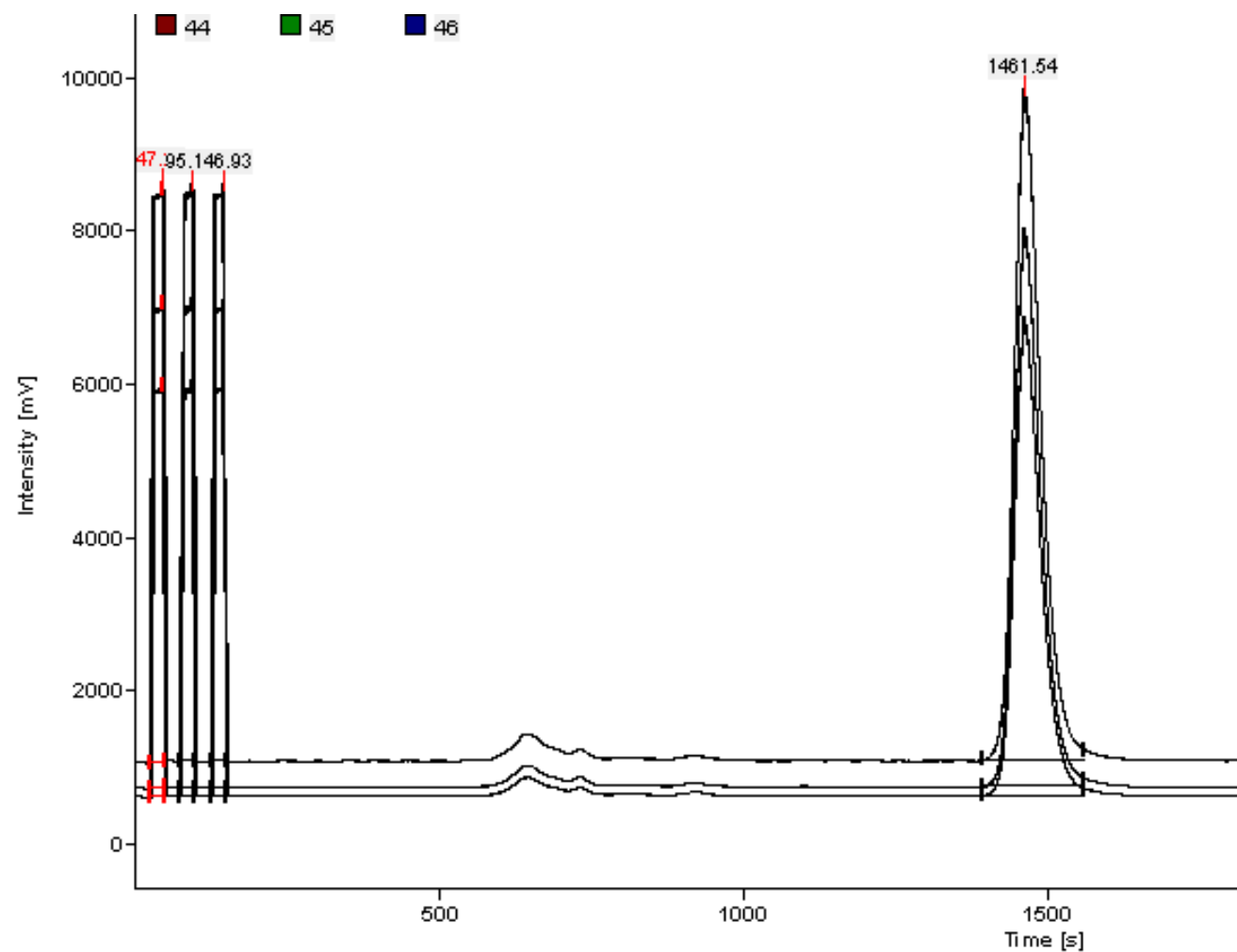

12. BIBLIOGRAPHY

1. Calderone G., Naulet N., Guillou C., Reniero F., “Characterization of European wine glycerol: stable carbon isotope approach”. *Journal of Agricultural and Food Chemistry*, 2004, 52, 5902-5906
2. Cabanero AI, Recio JL, Ruperez M. Simultaneous stable carbon isotopic analysis of wine glycerol and ethanol by liquid chromatography coupled to isotope ratio mass spectrometry

Total acidity
(OIV-OENO 551-2015)

1. Definition

The total acidity of the wine is the sum of its titratable acidities when it is titrated to pH 7 against a standard alkaline solution. Carbon dioxide is not included in the total acidity.

2. Principle

Potentiometric titration or titration with bromothymol blue as indicator and comparison with an end-point color standard.

3. Apparatus

3.1 *Water vacuum pump.*

3.2 *Vacuum flask, 500 mL.*

3.3 *Potentiometer* with scale graduated in pH values, and electrodes. The glass electrode must be kept in distilled water. The calomel/saturated potassium chloride electrode must be kept in a saturated potassium chloride solution.

3.4 *Beakers of 12 cm diameter.*

4. Reagents

4.1 *Buffer solution pH 7.0:*

potassium *di*-hydrogen phosphate, KH_2PO_4

107.3 g

sodium hydroxide solution, NaOH, 1 mol/L

500 mL

water to 1000 mL

Alternatively, ready-made buffer solutions are available commercially.

4.2 Sodium hydroxide solution, NaOH, 0.1 mol/L.

4.3 Bromothymol blue indicator solution, 4 g/L.

bromothymol blue 4
g

**COMPENDIUM OF INTERNATIONAL METHODS OF ANALYSIS -
OIV
Total acidity**

neutral ethanol, 96% (v/v)	200 mL
Dissolve and add:	
water free of CO ₂	200 mL
sodium hydroxide solution, 1 mol/L, sufficient to produce blue green color (pH 7)	7.5 mL
water to	1000 mL

5. Procedure

5.1 Preparation of sample: elimination of carbon dioxide.

Place approximately 50 mL of wine in a vacuum flask; apply vacuum to the flask using a water pump for one to two min, while shaking continuously.

5.2 Potentiometric titration

5.2.1 Calibration of pH meter

The pH meter is calibrated for use at 20°C, according to the manufacturer's instructions, with the pH 7 buffer solution at 20°C.

5.2.2 Method of measurement

Into a beaker, introduce a volume of the sample, prepared as described in 5.1, equal to 10 mL in the case of wine and 50 mL in the case of rectified concentrated must. Add about 10 mL of distilled water and then add sodium hydroxide solution, 0.1 mol/L, from a burette until the pH is equal to 7 at 20°C. The sodium hydroxide must be added slowly and the solution stirred continuously. Let *n* mL be the volume of sodium hydroxide, 0.1 mol/L, added.

5.3 Titration with indicator (bromothymol blue)

5.3.1 Preliminary test: end-point color determination.

Into a beaker (3.4) place 25 mL of boiled distilled water, 1 mL of bromothymol blue solution and a volume prepared as in 5.1 equal to 10 mL in the case of wine and 50 mL in the case of rectified concentrated must. Add sodium hydroxide solution,

**COMPENDIUM OF INTERNATIONAL METHODS OF ANALYSIS -
OIV
Total acidity**

0.1 mol/L, until the color changes to blue-green. Then add 5 mL of the pH 7 buffer solution.

5.3.2 Measurement

Into a beaker (3.4) place 30 mL of boiled distilled water, 1 mL of bromothymol blue solution and a volume of the sample, prepared as described in 5.1, equal to 10 mL in the case of wine and 50 mL in the case of rectified concentrated must. Add sodium hydroxide solution, 0.1 mol/L, until the same color is obtained as in the preliminary test above (5.3.1). Let n mL be the volume of sodium hydroxide solution, 0.1 mol/L, added.

6. Expression of results

6.1 Method of calculation

- The total acidity expressed in milliequivalents per liter is given by:

$$A = 10 n.$$

It is recorded to one decimal place.

- The total acidity expressed in grams of tartaric acid per liter is given by:

$$A' = 0.075 \times A$$

The result is quoted to two decimal places.

- The total acidity expressed in grams of sulfuric acid per liter is given by:

$$A' = 0.049 \times A$$

The result is quoted to two decimal places.

6.2 Repeatability (r) for titration with the indicator:(5.3):

$$r = 0.9 \text{ meq/L}$$

$$r = 0.04 \text{ g sulfuric acid/L}$$

$$r = 0.07 \text{ g tartaric acid/L}$$

6.3 Reproducibility (R) for titration with the indicator (5.3):

For white and rosé wines:

$$R = 3.6 \text{ meq/L}$$

$$R = 0.2 \text{ g sulfuric acid/L}$$

$$R = 0.3 \text{ g tartaric acid/L}$$

For red wines:

$$R = 5.1 \text{ meq/L}$$

**COMPENDIUM OF INTERNATIONAL METHODS OF ANALYSIS -
OIV**

Total acidity

R = 0.3 g sulfuric acid/L

R = 0.4 g tartaric acid/L

BIBLIOGRAPHY

SEMICHON L., FLANZY M., *Ann. Fals. Fraudes*, 1930, **23**,5.

FÉRE L., *Ibid.*, 1931, **24**, 75.

JAULMES P., *Bull. O.I.V.*, 1953, 26, n^o 274, 42; *Ann. Fals. Fraudes*, 1955, **48**, 157.

Volatile Acidity
(OIV-OENO 549-2015)

1. Definition

The volatile acidity is derived from the acids of the acetic series present in wine in the free state and combined as salts.

2. Principle

Carbon dioxide is first removed from the wine. Volatile acids are separated from the wine by steam distillation and titrated using standard sodium hydroxide.

The acidity of free and combined sulfur dioxide distilled under these conditions should be subtracted from the acidity of the distillate.

The acidity of any sorbic acid, which may have been added to the wine, must also be subtracted.

Note: Part of the salicylic acid used in some countries to stabilize the wines before analysis is present in the distillate. This must be determined and subtracted from the acidity. The method of determination is given in the Annex of this Chapter.

3 . Apparatus

3.1 Steam distillation apparatus consisting of:

- a steam generator; the steam must be free of carbon dioxide;
- a flask with steam pipe;
- a distillation column;
- a condenser.

This equipment must pass the following three tests:

- (a) Place 20 mL of boiled water in the flask. Collect 250 mL of the distillate and add to it 0.1 mL sodium hydroxide solution, 0.1 M, and two drops of phenolphthalein solution. The pink coloration must be stable for at least 10 sec (i.e. steam to be free of carbon dioxide).
- (b) Place 20 mL acetic acid solution, 0.1 M, in the flask. Collect 250 mL of the distillate. Titrate with the sodium hydroxide

**COMPENDIUM OF INTERNATIONAL METHODS OF ANALYSIS -
OIV
Volatile acidity**

solution, 0.1 M: the volume of the titer must be at least 19.9 mL (i.e. at least 99.5% of the acetic acid entrained with the steam).

- (c) Place 20 mL lactic acid solution, 1 M, in the flask. Collect 250 mL of the distillate and titrate the acid with the sodium hydroxide solution, 0.1 M.

The volume of sodium hydroxide solution added must be less than or equal to 1.0 mL (i.e. not more than 0.5% of lactic acid is distilled).

Any apparatus or procedure which passes these tests satisfactorily fulfils the requirements of official international apparatus or procedures.

3.2 Water aspirator vacuum pump.

3.3 Vacuum flask.

4. Reagents

4.1 Tartaric acid, crystalline.

4.2 Sodium hydroxide solution, 0.1 M.

4.3 Phenolphthalein solution, 1%, in neutral alcohol, 96% (*m/v*).

4.4 Hydrochloric acid ($\rho_{20} = 1.18$ to 1.19 g/mL) diluted 1/4 with distilled water.

4.5 Iodine solution, 0.005 M.

4.6 Potassium iodide, crystalline.

4.7 Starch solution, 5 g/L.

Mix 5 g of starch with about 500 mL of water. Bring to the boil, stirring continuously and boil for 10 min. Add 200 g sodium chloride. When cool, make up to one liter.

4.8 Saturated solution of sodium tetraborate, $\text{Na}_2\text{B}_4\text{O}_7 \cdot 10\text{H}_2\text{O}$, about 55 g/L at 20°C.

4.9 Acetic acid, 0.1 M.

4.10 Lactic acid solution, 0.1 M

100 mL of lactic acid is diluted in 400 mL of water. This solution is heated in an evaporating dish over a boiling water bath for four hours, topping up the volume occasionally with distilled water. After cooling, make up to a liter. Titrate the lactic acid in 10 mL of this solution with 1 M sodium hydroxide solution. Adjust the solution to 1 M lactic acid (90 g/L).

**COMPENDIUM OF INTERNATIONAL METHODS OF ANALYSIS -
OIV
Volatile acidity**

5. Procedure

5.1 *Preparation of sample*: elimination of carbon dioxide. Place about 50 mL of wine in a vacuum flask; apply vacuum to the flask with the water pump for one to two min while shaking continuously. Other CO₂ elimination systems may be used if the CO₂ elimination is guaranteed.

5.2 *Steam distillation*

Place 20 mL of wine, freed from carbon dioxide as in 5.1, into the flask. Add about 0.5 g of tartaric acid. Collect at least 250 mL of the distillate.

5.3 *Titration*

Titrate with the sodium hydroxide solution, (4.2), using two drops of phenolphthalein (4.3) as indicator. Let n mL be the volume of sodium hydroxide used.

Add four drops of the dilute hydrochloric acid (4.4), 2 mL starch solution (4.7) and a few crystals of potassium iodide (4.6). Titrate the free sulfur dioxide with the iodine solution, 0.005 M (4.5). Let n' mL be the volume used.

Add the saturated sodium tetraborate solution (4.8) until the pink coloration reappears. Titrate the combined sulfur dioxide with the iodine solution, 0.005 M (4.5). Let n'' mL be the volume used.

6. Expression of results

6.1 *Method of calculation*

The volatile acidity, expressed in milliequivalents per liter to one decimal place, is given by:

$$5 (n - 0.1 n' - 0.05 n'')$$

The volatile acidity, expressed in grams of sulfuric acid per liter to two decimal places, is given by:

$$0.245 (n - 0.1 n' - 0.05 n'')$$

The volatile acidity, expressed in grams of acetic acid per liter to two decimal places, is given by:

$$0.300 (n - 0.1 n' - 0.05 n'')$$

6.2 *Repeatability (r)* $r = 0.7$ meq/L

$$r = 0.03 \text{ g sulfuric acid/L}$$

$$r = 0.04 \text{ g acetic acid/L}$$

6.3 *Reproducibility (R)* $R = 1.3$ meq/L

$$R = 0.06 \text{ g sulfuric acid/L}$$

$$R = 0.08 \text{ g acetic acid/L}$$

**COMPENDIUM OF INTERNATIONAL METHODS OF ANALYSIS -
OIV
Volatile acidity**

6.4 *Wine with sorbic acid present*

Since 96% of sorbic acid is steam distilled with a distillate volume of 250 mL, its acidity must be subtracted from the volatile acidity, knowing that 100 mg of sorbic acid corresponds to an acidity of 0.89 milliequivalents or 0.053 g of acetic acid and knowing the concentration of sorbic acid in mg/L as determined by other methods.

ANNEX

**Determination of Salicylic Acid entrained in the distillate
from the volatile acidity**

1. Principle

After the determination of the volatile acidity and the correction for sulfur dioxide, the presence of salicylic acid is indicated, after acidification, by the violet coloration that appears when an iron (III) salt is added.

The determination of the salicylic acid entrained in the distillate with the volatile acidity is carried out on a second distillate having the same volume as that on which the determination of volatile acidity was carried out. In this distillate, the salicylic acid is determined by a comparative colorimetric method. It is subtracted from the acidity of the volatile acidity distillate.

2 Reagents

- Hydrochloric acid, HCl, (ρ_{20} = 1.18 to 1.19 g/L).
- Sodium thiosulfate solution, $\text{Na}_2\text{S}_2\text{O}_3 \cdot 5\text{H}_2\text{O}$, 0.1 M.
- Iron (III) ammonium sulfate solution, $\text{Fe}_2(\text{SO}_4)_3(\text{NH}_4)_2\text{SO}_4 \cdot 24\text{H}_2\text{O}$, 10% (m/v)
- Sodium salicylate solution, 0.01 M: containing 1.60 g/L sodium salicylate, $\text{NaC}_7\text{H}_5\text{O}_3$.

3. Procedure

3.1 Identification of salicylic acid in the volatile acidity distillate

Immediately after the determination of the volatile acidity and the correction for free and combined sulfur dioxide, introduce into a conical flask 0.5 mL hydrochloric acid, 3 mL of the sodium thiosulfate solution, 0.1 M, and 1 mL of the iron (III) ammonium sulfate solution. If salicylic acid is present, a violet coloration appears.

3.2 Determination of salicylic acid

On the above conical flask, indicate the volume of the distillate by a reference mark. Empty and rinse the flask.

Subject a new test sample of 20 mL wine to steam distillation and collect the distillate in the conical flask up to the reference mark. Add 0.3 mL concentrated hydrochloric acid, and 1 mL of the iron (III) ammonium sulfate solution. The contents of the conical flask turn violet.

Into a conical flask identical to that carrying the reference mark, introduce distilled water up to the same level as that of

**COMPENDIUM OF INTERNATIONAL METHODS OF ANALYSIS -
OIV
Volatile acidity**

the distillate. Add 0.3 mL concentrated hydrochloric acid and 1 mL of the iron (III) ammonium sulfate solution. From the burette run in the sodium salicylate solution, 0.01 M, until the violet coloration obtained has the same intensity as that of the conical flask containing the wine distillate.

Let n''' mL be the volume of solution added from the burette.

4. *Correction to the volatile acidity*

Subtract the volume $0.1 \times n''''$ mL from the volume n mL of sodium hydroxide solution, 0.1 M, used to titrate the acidity of the distillate during the determination of volatile acidity.

BIBLIOGRAPHY

Single method: JAULMES P., *Recherches sur l'acidité volatile des vins*, Thèse Diplom. Pharm. 1991, Montpellier, Nîmes.

JAULMES P., *Ann. Fals. Frauds*, 1950, **43**, 110.

JAULMES P., *Analyse des vins*, 1951, 396, Montpellier.

JAULMES P., *Bull. O.I.V.*, 1953., **26**, n^o 274, 48.

JAULMES P., MESTRES R., MANDROU Mlle B., *Ann. Fals. Exp. Chim.*, 1964, **57**, 119.

Fixed acidity
(A11, revised by OIV/OENO 377/2009)

1. Principle

The fixed acidity is calculated from the difference between total acidity and volatile acidity.

2. Expression of results

The fixed acidity is expressed in:

- milliequivalents per liter.
- grams of sulfuric acid per liter.
- grams of tartaric acid per liter.

Method OIV-MA-AS313-04

Type IV method

Organic acids

(Recueil OIV ed. 1990, revised by OIV/OENO 377/2009)

Wine organic acids may be separated and simultaneously determined by *high performance liquid chromatography* (HPLC).

1. Principle of method

Wine organic acids may be separated using two stationary phases: octyl-bonded silica and ion exchange resin columns. The acids are detected by spectrophotometric absorbance in ultraviolet.

For the determination of malic and tartaric acids, it is advisable to use an octyl-bonded silica column and for citric and lactic acids, an ion exchange resin column. The determination of these acids is performed with reference to an external standard analyzed under similar conditions.

This method is also able to give an evaluation of contents of shikimic, acetic, succinic and fumaric acids.

Note: other types of columns may also give a good separation. The columns and operating conditions given below are given as examples.

2. Apparatus

2.1. *Cellulose membrane filtration apparatus (diameter of pores: 0.45 μm)*

2.2. *Octadecyl-bonded silica fitted cartridges (e.g. Sep Pak - Waters Assoc.)*

2.3. *High Performance Liquid Chromatograph equipped with:*

- a 10 μL loop injector,
- a temperature control apparatus,
- spectrophotometer detector capable of making absorbance measurements at
210 nm,
- a chart recorder, or integrator.

Operating conditions

2.3.1 In the case of citric, lactic and acetic acid separation:

- a column containing a strong cation (H^+) exchange resin (300 mm length, 7.8 mm internal diameter, 9 μm particle size) (e.g. HPX-87 H BIO-RAD),
- mobile phase: sulfuric acid solution, 0.0125 mol/L,
- flow rate: 0.6 mL/min,
- temperature: 60 - 65°C. (Depending on the type of resin).

2.3.2 In the case of fumaric, succinic, shikimic, lactic, malic and tartaric acid separation.

- two columns (250 mm length, 4 mm internal diameter) placed in series, fitted with octyl-bonded silica, spherical particles of 5 μm diameter,
- mobile phase: potassium *di*-hydrogen phosphate solution, 70 g/L, ammonium sulfate, 14 g/L, and adjusted to pH 2.1 by adding phosphoric acid,
- flow rate: 0.8 mL/min,
- temperature: 20°C.

3. Reagents

- 3.1. Distilled water of HPLC quality
- 3.2. Distilled methanol
- 3.3. Tartaric acid
- 3.4. Malic acid
- 3.5. Sodium lactate
- 3.6. Shikimic acid
- 3.7. Sodium acetate
- 3.8. Succinic acid
- 3.9. Citric acid
- 3.10. Fumaric acid
- 3.11. Sulfuric acid ($\rho_{20} = 1.84$ g/mL)
- 3.12. Sulfuric acid solution, 0.0125 mol/L
- 3.13. Potassium *di*-hydrogen *ortho*-phosphate, KH_2PO_4
- 3.14. Ammonium sulfate, $(NH_4)_2SO_4$
- 3.15. *Ortho*-phosphoric acid, 85% ($\rho_{20} = 1.71$ g/mL)

- 3.16. Reference solution made of: tartaric acid, 5 g/L, malic acid, 5 g/L, sodium lactate, 6.22 g/L, shikimic acid, 0.05 g/L, sodium acetate, 6.83 g/L, succinic acid, 5 g/L, fumaric acid, 0.01 g/L and citric acid, 5 g/L.

4. Procedure

4.1. Preparation of sample

First wash cartridge (2.2) with 10 mL methanol (3.2) then with 10 mL water (3.1).

Remove gas from wine or must sample. Filter through membrane (0.45 µm) (2.1). Put 8 mL of filtered sample into a syringe already rinsed with the sample; pass through the cartridge. Disregard the first 3 mL and collect the following 5 mL (prevent the cartridge from becoming dry).

4.2. Chromatography

Inject successively into the chromatograph 10 µL reference solution and 10 µL sample solution prepared according to 4.1. Repeat these injections three times in the same order.

5. Calculation

5.1. Qualitative analysis

Determine the respective times of retention for each of the eluates.

The organic acids of the reference solution are divided in order of elution as follows:

- citric, tartaric, malic, succinic + shikimic, lactic, fumaric and acetic acids in the technique 2.3.1.
- tartaric, malic, shikimic, lactic, acetic, citric, succinic and fumaric acids in the technique 2.3.2.

5.2. Quantitative analysis

Measure the area of each of the peaks and determine the average of the three answers for the reference and sample solutions to be analyzed. Deduct the sample concentration from the organic acids.

6. Expression of results

The concentrations are expressed as follows:

- grams per liter to one decimal place for the tartaric, malic, lactic and succinic acids
- milligrams per liter for the citric, acetic and fumaric acids.

BIBLIOGRAPHY

TUSSEAU D. et BENOIT C., *F.V., O.I.V.*, 1986, n^{os} 800 et 813; *J. Chromatogr.*, 1987, **395**, 323-333.

Tartaric acid
(A12 revised by OIV/OENO 377/2009)

1. Principle

Tartaric acid is precipitated in the form of calcium (\pm)tartrate and determined gravimetrically. This determination may be completed using a volumetric procedure for comparison. The conditions for precipitation (pH, total volume used, concentrations of precipitating ions) are such that precipitation of the calcium (\pm)tartrate is complete whereas the calcium D(-) tartrate remains in solution.

When *meta*-tartaric acid has been added to the wine, which causes the precipitation of the calcium (\pm)tartrate to be incomplete, it must first be hydrolyzed.

2. Method

2.1. *Gravimetric method*

2.1.1. Reagents

- Calcium acetate solution containing 10 g of calcium per liter:

Calcium carbonate, CaCO ₃	25 g
Acetic acid, glacial, CH ₃ COOH (ρ_{20} = 1.05 g/mL)	40 mL
Water to	1000 mL

- Calcium (\pm)tartrate, crystallized: CaC₄O₆H₄·4H₂O.

Place 20 mL of L(+) tartaric acid solution, 5 g/L, into a 400 mL beaker.

Add 20 mL of ammonium D(-) tartrate solution, 6.126 g/L, and 6 mL of calcium acetate solution containing 10 g of calcium per liter.

Allow to stand for two hours to precipitate. Collect the precipitate in a sintered glass crucible of porosity No 4, and wash it three times with about 30 mL of distilled water. Dry to constant weight in the oven at 70°C. Using the quantities of reagent indicated above, about 340 mg of crystallized calcium (\pm) tartrate is obtained. Store in a stoppered bottle.

- Precipitation solution (pH 4.75):

D(-) ammonium tartrate	150 mg
------------------------------	--------

COMPENDIUM OF INTERNATIONAL METHODS OF ANALYSIS – OIV
Tartaric acid

Calcium acetate solution, 10 g calcium/L
8.8 mL
Water to 1000 mL

Dissolve the D(-) ammonium tartrate in 900 mL water; add 8.8 mL calcium acetate solution and make up to 1000 mL. Since calcium (\pm)tartrate is slightly soluble in this solution, add 5 mg of calcium (\pm)tartrate per liter, stir for 12 hours and filter.

Note: The precipitation solution may also be prepared from D(-) tartaric acid.

D(-) tartaric acid 122 mg
Ammonium hydroxide solution (ρ_{20} = 0.97 g/mL), 25 % (v/v)
0.3 mL

Dissolve the D(-) tartaric acid, add the ammonium hydroxide solution and make up to about 900 mL; add 8.8 mL of calcium acetate solution, make up to a liter and adjust the pH to 4.75 with acetic acid. Since calcium (\pm)tartrate is slightly soluble in this solution, add 5 mg of calcium (\pm)tartrate per liter, stir for 12 hours and filter.

2.1.2. Procedure

— Wines with no added *meta*-tartaric acid

Place 500 mL of precipitation solution and 10 mL of wine into a 600 mL beaker. Mix and initiate precipitation by rubbing the sides of the vessel with the tip of a glass rod. Leave to precipitate for 12 hours (overnight).

Filter the liquid and precipitate through a weighed sintered glass crucible of porosity No. 4 fitted on a clean vacuum flask. Rinse the vessel in which precipitation took place with the filtrate to ensure that all precipitate is transferred.

Dry to constant weight in an oven at 70°C. Weigh. Let p be the weight of crystallized calcium (\pm)tartrate, $\text{CaC}_4\text{O}_6\text{H}_4 \cdot 4\text{H}_2\text{O}$, obtained.

— Wines to which *meta*-tartaric acid has been added.

When analyzing wines to which *meta*-tartaric acid has been or is suspected of having been added, proceed by first hydrolyzing this acid as follows:

COMPENDIUM OF INTERNATIONAL METHODS OF ANALYSIS – OIV
Tartaric acid

Place 10 mL of wine and 0.4 mL of glacial acetic acid, CH₃COOH, (ρ_{20} = 1.05 g/mL) into a 50 mL conical flask. Place a reflux condenser on top of the flask and boil for 30 min. Allow to cool and then transfer the solution in the conical flask to a 600 mL beaker. Rinse the flask twice using 5 mL of water each time and then continue as described above.

Meta-Tartaric acid is calculated and included as tartaric acid in the final result.

2.1.3. Expression of results

One molecule of calcium (\pm)tartrate corresponds to half a molecule of L(+) tartaric acid in the wine.

- The quantity of tartaric acid per liter of wine, expressed in milliequivalents, is equal to:

384.5 p.

It is quoted to one decimal place.

- The quantity of tartaric acid per liter of wine, expressed in grams of tartaric acid, is equal to:

28.84 p.

It is quoted to one decimal place.

- The quantity of tartaric acid per liter of wine, expressed in grams of potassium tartrate, is equal to:

36.15 p.

It is quoted to one decimal place.

2.2. Comparative volumetric analysis

2.2.1. Reagents

- Hydrochloric acid (ρ_{20} = 1.18 to 1.19 g/mL) diluted 1:5 with distilled water

- EDTA solution, 0.05 M:

EDTA (ethylenediaminetetraacetic acid disodium salt).....	18.61 g
Water to	1000 mL

- Sodium hydroxide solution, 40% (m/v):

Sodium hydroxide, NaOH	40 g
Water to	100 mL

- Complexometric indicator: 1% (m/m)

2-hydroxy-1-(2-hydroxy-4-sulpho-1-naphthylazo)

-3-naphthoic acid	1 g
-------------------------	-----

COMPENDIUM OF INTERNATIONAL METHODS OF ANALYSIS – OIV
Tartaric acid

Sodium sulfate, Na₂SO₄ (anhydrous) 100 g

2.2.2. Procedure

After weighing, replace the sintered glass crucible containing the precipitate of calcium (±)tartrate on the vacuum flask and dissolve the precipitate with 10 mL of dilute hydrochloric acid. Wash the sintered glass crucible with 50 mL of distilled water. Add 5 mL 40% sodium hydroxide solution and about 30 mg of indicator. Titrate with EDTA solution, 0.05 M. Let the number of mL used be n .

2.2.3. Expression of results

- The quantity of tartaric acid per liter of wine, expressed in milliequivalents, is equal to:

$5 n$.

It is quoted to one decimal place.

- The quantity of tartaric acid per liter of wine, expressed in grams of tartaric acid, is equal to:

$0.375 n$.

It is quoted to one decimal place.

- The quantity of tartaric acid per liter of wine, expressed in grams of potassium acid tartrate, is equal to:

$0.470 n$.

It is quoted to one decimal place.

BIBLIOGRAPHY

- KLING A., *Bull. Soc. Chim.*, 1910, **7**, 567.
KLING A., FLORENTIN D., *Ibid*, 1912, **11**, 886.
SEMICHON L., FLANZY M., *Ann. Fals. Fraudes*, 1933, **26**, 404.
PEYNAUD E., *Ibid*, 1936, **29**, 260.
PATO M., *Bull. O.I.V.*, 1944, **17**, n^o, 161, 59, n^o, 162, 64.
POUX C., *Ann. Fals. Fraudes*, 1949, **42**, 439.
PEYNAUD E., *Bull. Soc. Chim. Biol.*, 1951, **18**, 911; *Ref. Z. Lebensmit. Forsch.*, 1953, **97**, 142.
JAULMES P., BRUN Mme S., VASSAL Mlle M., *Trav. Soc. Pharm.*, Montpellier, 1961, **21**, 46-51.

COMPENDIUM OF INTERNATIONAL METHODS OF ANALYSIS – OIV
Tartaric acid

JAULMES P., BRUN Mme S., CABANIS J.C., *Bull. O.I.V.*, 1969, n^{OS}
462-463, 932.

Method OIV-MA-AS313-05B

Tartaric acid

1. Principle

The tartaric acid, separated using an ion exchange column, is determined colorimetrically in the eluate by measurement of the red color produced on reaction with vanadic acid. The eluate also contains lactic and malic acids that do not interfere.

WITHDRAWN
(resolution OIV/OENO 377/2009)

Method OIV-MA-AS313-06

Lactic acid

1. Principle

The lactic acid, separated by passage through an ion exchange resin column, is oxidized to acetaldehyde (ethanol) and determined by colorimetry after reacting with sodium nitroprusside and piperidine.

WITHDRAWN
(Resolution OIV/OENO 377/2009)

**COMPENDIUM OF INTERNATIONAL METHODS OF ANALYSIS -
OIV
Lactic acid**

Method OIV-MA-AS313-07

Type II method

Lactic acid

Enzymatic method

(Recueil OIV ed. 1990; revised by OIV/OENO 377/2009)

1. Principle

Total lactic acid (L-lactate and D-lactate) is oxidized by nicotinamide adenine dinucleotide (NAD) to pyruvate in a reaction catalyzed by L-lactate dehydrogenase (L-LDH) and D-lactate dehydrogenase (D-LDH).

The equilibrium of the reaction normally lies more strongly in favor of the lactate. Removal of the pyruvate from the reaction mixture displaces the equilibrium towards the formation of pyruvate.

In the presence of L-glutamate, the pyruvate is transformed into L-alanine in a reaction catalyzed by glutamate pyruvate transaminase (GPT):

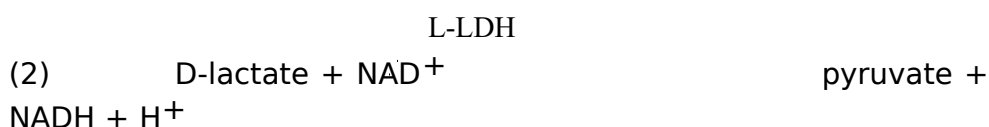
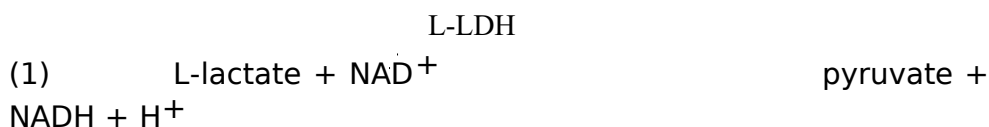

The amount of NADH formed, measured by the increase in absorbance at the wavelength of 340 nm, is proportional to the quantity of lactate originally present.

Note: L-lactic acid may be determined independently by using reactions (1) and (3), while D-lactic acid may be similarly determined by using reactions (2) and (3).

2. Apparatus

2.1. A spectrophotometer permitting measurements to be made at 340 nm, the wavelength at which the absorbance of NADH is a maximum.

**COMPENDIUM OF INTERNATIONAL METHODS OF ANALYSIS -
OIV
Lactic acid**

Failing that, a spectrophotometer with a discontinuous spectrum source permitting measurements to be made at 334 or 365 nm may be used.

2.2. Glass cells with optical path lengths of 1 cm or single-use-cells.

2.3. Micropipettes for pipetting sample volumes in the range 0.02 to 2 mL.

3. Reagents

Double-distilled water

3.1. Buffer solution, pH 10 (glycylglycine, 0.6 M; L-glutamate, 0.1 M):

Dissolve 4.75 g of glycylglycine and 0.88 g of L-glutamic acid in approximately 50 mL of double distilled water; adjust the pH to 10 with a few milliliters sodium hydroxide, 10 M, and make up to 60 mL with double distilled water.

This solution will remain stable for at least 12 weeks at 4°C.

3.2. Nicotinamide adenine dinucleotide (NAD) solution, approximately 40×10^{-3} M: dissolve 900 mg of NAD in 30 mL of double distilled water. This solution will remain stable for at least four weeks at 4°C.

3.3. Glutamate pyruvate transaminase (GPT) suspension, 20 mg/mL.

The suspension remains stable for at least a year at 4°C.

3.4. L-lactate dehydrogenase (L-LDH) suspension, 5 mg/mL.

This suspension remains stable for at least a year at 4°C.

3.5. D-lactate dehydrogenase (D-LDH) suspension, 5 mg/mL.

This suspension remains stable for at least a year at 4°C.

It is recommended that, prior to the determination, the enzyme activity should be checked.

Note: All the reagents are available commercially.

4. Preparation of the sample

Lactate determination is normally carried out directly on the wine, without prior removal of pigmentation (coloration) and without dilution provided that the lactic acid concentration is less than 100 mg/L. However, if the lactic acid concentration lies between: 100 mg/L and 1 g/L, dilute 1/10 with double distilled water, 1 g/L and 2.5 g/L, dilute 1/25 with double distilled water, 2.5 g/L and 5 g/L, dilute 1/50 with double distilled water.

5. Procedure

Preliminary note:

**COMPENDIUM OF INTERNATIONAL METHODS OF ANALYSIS -
OIV
Lactic acid**

No part of the glassware that comes into contact with the reaction mixture should be touched with the fingers, since this could introduce L-lactic acid and thus give erroneous results.

The buffer solution must be at a temperature between 20 and 25°C before proceeding to the measurement.

5.1. Determination of total lactic acid

With the spectrophotometer adjusted to a wavelength of 340 nm, determine the absorbance using 1 cm cells, with air as the zero absorbance (reference) standard; (no cell in the optical path) or with water as the standard.

Place the following in the 1 cm cells:

cell	Reference cell		Sample
	(mL)	(mL)	
Solution 3.1.	1.00	1.00	
Solution 3.2.	0.20	0.20	
Double distilled water		1.00	
	0.80		
Suspension 3.3.		0.02	
	0.02		
Sample to be measured		—	
	0.20		

Mix using a glass stirrer or a rod of synthetic material with a flattened end; after about five min, measure the absorbencies of the solutions in the reference and sample cells (A_1).

Add 0.02 mL of solution 3.4 and 0.05 mL of solution 3.5, homogenize, wait for the reaction to be completed (about 30 min) and measure the absorbencies of the solutions in the reference and sample cells (A_2).

Calculate the differences ($A_2 - A_1$) in the absorbencies of the solutions in the reference and sample cells, ΔA_S and ΔA_R .

Finally, calculate the difference between those differences:

$$\Delta A = \Delta A_S - \Delta A_R$$

5.2. Determination of L-lactic acid and D-lactic acid

Determination of the L-lactic acid or D-lactic acid can be carried out independently by applying the procedure for total lactic acid up to the determination of A_1 and then continuing as follows:

Add 0.02 mL of solution 3.4, homogenize, wait until the reaction is complete (about 20 min) and measure the

**COMPENDIUM OF INTERNATIONAL METHODS OF ANALYSIS -
OIV
Lactic acid**

absorbencies of the solutions in the reference and sample cells (A_2).

Add 0.05 mL of solution 3.5, homogenize, wait until the reaction is complete (about 30 min) and measure the absorbencies of the solutions in the reference and sample cells (A_3).

Calculate the differences ($A_2 - A_1$) for L-lactic acid and ($A_3 - A_2$) for D-lactic acid between the absorbencies of the solutions in the reference and sample cells, ΔA_S and ΔA_R .

Finally, calculate the difference between those differences:

$$\Delta A = A_S - \Delta A_R.$$

Note: The time needed for the completion of enzyme activity can vary from one batch to another. The above value is given only for guidance and it is recommended that it be determined for each batch. When determining the L-lactic acid alone, the incubation time may be reduced to 10 min.

6. Expression of results

Lactic acid concentration is given in grams per liter (g/L) to one decimal place.

6.1. Method of calculation

The general formula for calculating the concentration in g/L is:

$$C = \frac{V \times M}{\varepsilon \times \delta \times v \times 1000} \times \Delta A$$

where

V = volume of test solution in mL ($V = 2.24$ mL for L-lactic acid, $V = 2.29$ mL for D-lactic acid and total lactic acid)

v = volume of the sample in mL (0.2 mL)

M = molecular mass of the substance to be determined (for DL-lactic acid, $M = 90.08$)

δ = optical path in the cell in cm (1 cm)

ε = absorption coefficient of NADH, at 340 nm

$$(\varepsilon = 6.3 \text{ mmol}^{-1} \times 1 \text{ cm}^{-1}).$$

6.1.1 Total lactic acid and D-lactic acid

$$C = 0.164 \times \Delta A$$

If the sample was diluted during its preparation, multiply the result by the dilution factor.

Note:

- Measurement at 334 nm: $C = 0.167 \times \Delta A$, ($\varepsilon = 6.2 \text{ mmol}^{-1} \times 1 \text{ cm}^{-1}$).

**COMPENDIUM OF INTERNATIONAL METHODS OF ANALYSIS -
OIV
Lactic acid**

- Measurement at 365 nm: $C = 0.303 \times \Delta A$, ($\varepsilon = 3.4 \text{ mmol}^{-1} \times 1 \text{ x cm}^{-1}$).

6.1.2 L-lactic acid

$$C = 0.160 \times \Delta A$$

If the sample was diluted during its preparation, multiply the result by the dilution factor.

Note:

- Measurement at 334 nm: $C = 0.163 \times \Delta A$, ($\varepsilon = 6.2 \text{ mmol}^{-1} \times 1 \text{ x cm}^{-1}$).
- Measurement at 365 nm: $C = 0.297 \times \Delta A$, ($\varepsilon = 3.4 \text{ mmol}^{-1} \times 1 \text{ x cm}^{-1}$).

6.2 Repeatability (*r*)

$$r = 0.02 + 0.07 x_i$$

x_i is the lactic acid concentration in the sample in g/L.

6.3. Reproducibility (*R*)

$$R = 0.05 + 0.125 x_i$$

x_i is the lactic acid concentration in the sample in g/L.

BIBLIOGRAPHY

HOHORST H.J., in *Méthodes d'analyse enzymatique*, par BERGMEYER H.U., 2^e éd., p. 1425, Verlag-Chemie Weinheim/Bergstraße, 1970.

GAWEHN K. et BERGMEYER H.U., *ibid.*, p. 1450.

BOEHRINGER, Mannheim, *Méthodes d'analyse enzymatique en chimie alimentaire*, documentation technique.

JUNGE Ch., *F.V., O.I.V.*, 1974, n^o 479.

VAN DEN DRIESSCHE S. et THYS L., *F.V., O.I.V.*, 1982, n^o 755.

Citric acid

Chemical method

1. Principle

Citric acid is fixed with other wine acids onto an anion exchange column. The citramalic acid is obtained by fractionating the elute. The citric acid is oxidized to acetone, which is separated by distillation. The acetaldehyde (ethanol) is oxidized to acetic acid and acetone is determined by iodometry.

2. Apparatus

2.1. Anion exchange column

In a 25 mL burette with tap, place a glass wool plug and pour 20 mL of Dowex resin 1 x 2.

Initially the resin goes through two complete regeneration cycles with alternate passages of hydrochloric acid solution, 1 M, and sodium hydroxide solution, 1 M. Rinse with 50 mL distilled water ⁽¹⁾. Saturate the resin with acetate ions by adding 250 mL acetic acid solution, 4 M. Wash with 100 mL distilled water.

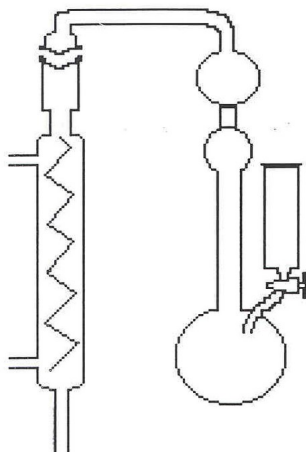

The sample is passed through a column conforming to the description below. After the elution of the acids, rinse with 50 mL of distilled water and proceed once more to saturate the resin with acetic acid solution, 4 M. Rinse with 100 mL water. The resin is then ready for re-use.

2.2. Oxidation apparatus

The use of a distillation apparatus with oxidation round bottom flask, see

⁽¹⁾ The passage of the sodium hydroxide causes a contraction that, followed by a swelling during washings, stops the flow. It is recommended to stir the resin as soon as the first few mL of water pass through the column to stop the resin from sticking to the bottom of the burette.

**COMPENDIUM OF INTERNATIONAL METHODS OF ANALYSIS -
OIV
Citric acid**

drawing Fig. 1 facilitates the introduction of potassium permanganate, with a very regular flow.

If unavailable, use a 500 mL round bottom flask and a funnel fitted with a tap and a tapered end, to ensure that there is as regular flow of potassium permanganate as possible.

Fig: 1 The oxidation and distillation apparatus for the determination of citric acid

3. Reagents

- Dowex resin 1 x 2 (50 - 100 mesh)
- Acetic acid solution, 4 M
- Acetic acid solution, 2.5 M
- Sodium hydroxide solution, 2 M
- Sulfuric acid ($r_{20} = 1.84$ g/mL) diluted $\frac{1}{5}$ (v/v)
- Buffer solution of pH 3.2 - 3.4

Potassium *di*-hydrogen phosphate KH_2PO_4 150

g

Concentrated phosphoric acid ($p_{20} = 1.70$ g/mL) 5

mL

Water to: 1000 mL

- Manganese sulfate solution, $\text{MnSO}_4 \cdot \text{H}_2\text{O}$, 50 g/L
- Pumice stone
- Potassium permanganate solution, 0.01 M
- Sulfuric acid ($r_{20} = 1.84$ g/mL) diluted $\frac{1}{3}$ (v/v)
- Potassium permanganate solution, 0.4 M
- Iron (II) sulfate, $\text{FeSO}_4 \cdot 7\text{H}_2\text{O}$, 40% (m/v)
- Sodium hydroxide solution, 5 M
- Iodine solution, 0.01 M
- Sodium thiosulfate solution, 0.02 M
- Thiodene or starch

4. Method

4.1 Separation of citramalic and citric acids

Pass 25 mL wine through the ion exchange Dowex 1 x 2 resin column (in an acetate form) at a flow rate of 3 mL every 2 minutes. Rinse the column three times with 20 mL distilled water. Elute the acids with 200 mL acetic acid solution, 2.5 M, at the same flow rate. This eluate fraction contains succinic, lactic, galacturonic, citramalic acids and nearly all of the malic acid.

Proceed with the elution of citric and tartaric acids by passing 100 mL sodium hydroxide solution, 2 M, through the column. Collect the eluate in the oxidation flask.

**COMPENDIUM OF INTERNATIONAL METHODS OF ANALYSIS -
OIV
Citric acid**

4.2. Oxidation

In the flask containing this second eluate, add sulfuric acid diluted 1/5 (about 20 mL) to bring the pH to between 3.2 and 3.8. Add 25 mL of pH 3.2-3.4 buffer solution, 1 mL of manganese sulfate solution and few grains of pumice stone.

Bring to the boil and distil over 50 mL, which is discarded.

Put the potassium permanganate solution, 0.01 M, in the funnel and introduce at 1 drop per second into the boiling eluate. The distillate is collected in a 500 mL ground glass stoppered flask containing few millimeters of water. The oxidation is carried on until a brown coloration of the liquid appears indicating an excess of permanganate.

4.3. Separation of the acetone

If the volume of the distillate is less than 90 mL, make up with distilled water, add 4.5 mL of sulfuric acid diluted $\frac{1}{3}$, and 5 mL potassium permanganate solution, 4.4 M. If the collected distillate largely exceeds this volume, complete to 180 mL and double the amounts of the reagents.

Under those conditions (i.e. sulfuric acid, 0.25 M, and potassium permanganate, 0.02 M), acetaldehyde (ethanol) is oxidized into acetic acid while acetone remains intact.

The stoppered flask is left to rest for 45 minutes at room temperature. After which the excess of permanganate is destroyed by addition of iron (II) sulfate solution.

Distillate and collect about 50 mL of distillate in a ground glass stoppered flask containing 5 mL sodium hydroxide solution, 5 M.

4.4. Determination of acetone

Add 25 mL iodine solution, 0.01 M, to the flask *. Leave for 20 minutes. Add 8 mL of sulfuric acid diluted 1/5. Titrate the excess of iodine by sodium thiosulfate, 0.02 M, in the presence of thiodene or starch, n mL.

Under the same conditions make a blank determination replacing 50 mL of distillate by 50 mL of distilled water.

n' mL of thiosulfate used.

* This amount is suitable for citric acid contents not exceeding 0.5 to 0.6 g/L. For higher contents the volume of the iodine solution prescribed is not sufficient and the solution does not take a yellow color which is typical of an iodine excess. In this case double or triple the quantity of iodine until the solution becomes really yellow. However, in exceptional cases where the amount of citric acid in wine exceeds 1.5 g/L, it is recommended to restart the analysis on 10 mL of wine.

**COMPENDIUM OF INTERNATIONAL METHODS OF ANALYSIS -
OIV
Citric acid**

5. Calculations

1 mL iodine, 0.01 M, corresponds to 0.64 mg of citric acid.

Under the same given conditions, the quantity of citric acid in milligrams per liter corresponds to:

$$(n' - n) \times 25.6$$

6. Expression of results

The concentration of citric acid is expressed in milligrams per liter.

BIBLIOGRAPHY

- KOGEN A., *Z. Anal. chem.*, 1930, **80**, 112.
BARTELS W., *Z. Unters. Lebensm.* 1933, **65**, 1.
PEYNAUD E., *Bull. O.I.V.*, 1938, **11**, n^o 118, 33.
GODET C., CHARRIERE R., *Trav. Chim. Alim. Hyg.*, 1948, **37**, 317.
KOURAKOU Mme S., *Ann. Fals. Exp. Chim.*, 1962, **55**, 149.

Citric acid

Enzymatic method

(Recueil OIV ed. 1990, revised by OIV/OENO 377/2009)

1. Principle

Citric acid is converted into oxaloacetate and acetate in a reaction catalyzed by citratelase (CL):

CL

Citrate → oxaloacetate + acetate

In the presence of malate dehydrogenase (MDH) and lactate dehydrogenase (LDH), the oxaloacetate and its decarboxylation derivative, pyruvate, are reduced to L-malate and L-lactate by reduced nicotinamide adenine dinucleotide (NADH):

MDH

oxaloacetate + NADH + H⁺ → L-malate + NAD⁺

LDH

pyruvate + NADH + H⁺ → L-lactate + NAD⁺

The amount of NADH oxidized to NAD⁺ in these reactions is proportional to the amount of citrate present. The oxidation of NADH is measured by the resultant decrease in absorbance at a wavelength of 340 nm.

2. Apparatus

2.1 A spectrophotometer permitting measurement to be made at 340 nm, the wavelength at which absorbance of NADH is a maximum.

Alternatively, a spectrophotometer, with a discontinuous spectrum source permitting measurements to be made at 334 nm or 365 nm, may be used.

Since absolute absorbance measurements are involved (i.e. calibration curves are not used but standardization is made by consideration of the extinction coefficient of NADH), the

**COMPENDIUM OF INTERNATIONAL METHODS OF ANALYSIS -
OIV
Citric acid**

wavelength scales and spectral absorbance of the apparatus must be checked.

2.2 Glass cells with optical path lengths of 1 cm or single-use cells.

2.3 Micropipettes for pipetting volumes in the range 0.02 to 2 mL.

3. Reagents

3.1 Buffer solution pH 7.8 (glycylglycine, 0.51 M; pH 7.8; Zn⁺(0.6 x 10⁻³ M):

dissolve 7.13 g of glycylglycine in approximately 70 mL of double distilled water. Adjust the pH to 7.8 with approximately 13 mL sodium hydroxide solution, 5 M, add 10 mL of zinc chloride, ZnCl₂, (80 mg in 100 mL double distilled water) solution and make up to 100 mL with double distilled water.

3.2 Reduced nicotinamide adenine dinucleotide, NADH, solution (approximately 6 x 10⁻³M): dissolve 30 mg NADH and 60 mg NaHCO₃ in 6 mL of double distilled water.

3.3 Malate dehydrogenase/lactate dehydrogenase solution (MDH/LDH) (0.5 mg MDH/mL; 2.5 mg LDH/mL): mix together 0.1 mL MDH (5 mg MDH/mL), 0.4 mL ammonium sulfate solution, 3.2 M, and 0.5 mL LDH (5 mg/mL).

This suspension remains stable for at least a year at 4°C.

3.4 Citrate-lyase (CL, 5 mg protein/mL): dissolve 168 mg lyophilisate in 1 mL ice-cold water. This solution remains stable for at least a week at 4°C and for at least four weeks if frozen.

It is recommended that, prior to the determination, the enzyme activity should be checked.

3.5 Polyvinylpolypyrrolidone (PVPP).

Note: All the reagents above are available commercially.

4. Preparation of the sample

Citrate determination is normally carried out directly on wine, without preliminary removal of pigmentation (coloration) and without dilution, provided that the citric acid content is less than 400 mg/L. If not, dilute the wine until the citrate concentration lies between 20 and 400 mg/L (i.e. between 5 and 80 µg of citrate in the test sample).

**COMPENDIUM OF INTERNATIONAL METHODS OF ANALYSIS -
OIV
Citric acid**

With red wines that are rich in phenolic compounds, preliminary treatment with PVPP is recommended:

Form a suspension of about 0.2 g of PVPP in water and allow to stand for 15 min. Filter using a fluted filter.

Place 10 mL of wine in a 50 mL conical flask, add the moist PVPP removed from the filter with a spatula. Shake for two to three minutes. Filter.

5. Procedure

With the spectrophotometer adjusted to a wavelength of 340 nm, determine the absorbance using the 1 cm cells, with air as the zero absorbance (reference) standard (no cell in the optical path). Place the following in the 1 cm cells:

Sample cell	Reference	cell
(mL)	(mL)	
Solution 3.1	1.00	1.00
Solution 3.2	0.10	0.10
Sample to be measured	-	
	0.20	
Double distilled water	2.00	1.80
Solution 3.3	0.02	0.02

Mix, and after about five min read the absorbance of the solutions in the reference and sample cells (A_1).

**COMPENDIUM OF INTERNATIONAL METHODS OF ANALYSIS -
OIV
Citric acid**

Add:

Solution 3.4 0.02 mL 0.02 mL

Mix; wait until the reaction is completed (about five min) and read the absorbance of the solutions in the reference and sample cells (A_2).

Calculate the absorbance difference ($A_1 - A_2$) for the reference and sample cells, ΔA_S and ΔA_R .

Finally, calculate the difference between those differences:

$$\Delta A = \Delta A_S - \Delta A_R.$$

Note: The time needed for the completion of enzyme activity can vary from one batch to another. The above value is given only for guidance and it is recommended that it be determined for each batch.

6. Expression of results

Citric acid concentration is given in milligrams per liter to the nearest whole number.

6.1 Method of calculation

The general formula for calculating the concentration in mg/L is:

$$C = \frac{V \times M}{\epsilon \times d \times v} \times \Delta A$$

where:

V = volume of test solution in mL (3.14 mL)

v = volume of the sample in mL (0.2 mL)

M = molecular mass of the substance to be determined
(for anhydrous citric acid, M = 192.1)

d = optical path in the cell in cm (1 cm)

ϵ = absorption coefficient of NADH, (at 340 nm, $\epsilon = 6.3 \text{ mmol}^{-1} \times \text{l} \times \text{cm}^{-1}$).

so that:

$$C = 479 \times \Delta A$$

If the sample was diluted during its preparation, multiply the result by the dilution factor.

Note:

- At 334 nm: $C = 488 \times \Delta A$ ($\epsilon = 6.3 \text{ mmol}^{-1} \times \text{l} \times \text{cm}^{-1}$).
- At 365 nm: $C = 887 \times \Delta A$ ($\epsilon = 3.4 \text{ mmol}^{-1} \times \text{l} \times \text{cm}^{-1}$).

6.2 Repeatability (r)

Citric acid concentration less than 400 mg/L: $r = 14 \text{ mg/L}$.

**COMPENDIUM OF INTERNATIONAL METHODS OF ANALYSIS -
OIV
Citric acid**

Citric acid concentration greater than 400 mg/L: $r = 28$ mg/L.

6.3 Reproducibility (R)

Citric acid concentration less than 400 mg/L: $R = 39$ mg/L.

Citric acid concentration greater than 400 mg/L: $R = 65$ mg/L.

BIBLIOGRAPHY

- MAYER K. et PAUSE G., *Lebensm. Wiss. u. Technol.*, 1969. **2**, 143
JUNGE Ch., *F.V., O.I.V.*, 1970, n^o 364
BOEHRINGER, Mannheim, *Méthodes d'analyse enzymatique en chimie alimentaire*, documentation technique.
VAN DEN DREISCHE S. et THYS L., *F.V., O.I.V.*, 1982, n^o 755.

Total Malic Acid
(A33 revised by OIV/OENO 377/2009)

1. Principle

Malic acid, separated by means of an anion exchange column, is determined colorimetrically in the eluent by measuring the yellow coloration it forms with chromotropic acid in the presence of concentrated sulfuric acid. A correction for interfering substances is made by subtracting the absorbance, obtained using 86% sulfuric and chromotropic acid respectively (malic acid does not react at these acid concentrations), from the absorbance obtained from using 96% strength acids.

2. Apparatus

- 2.1 Glass column 250 mm approximately in length and 35 mm internal diameter, fitted with drain tap.
- 2.2 Glass column approximately 300 mm in length and 10 to 11 mm internal diameter, fitted with drain tap.
- 2.3 Thermostatically controlled water bath at 100°C.
- 2.4 Spectrophotometer set to measure absorbance at 420 nm using cells of 1 cm optical path.

3. Reagents

- 3.1 A strongly basic anion exchanger (e.g. Merck III)
- 3.2 Sodium hydroxide, 5% (*m/v*).
- 3.3 Acetic acid, 30% (*m/v*).
- 3.4 Acetic acid, 0.5% (*m/v*).
- 3.5 Sodium sulfate solution, 10% (*m/v*).
- 3.6 Concentrated sulfuric acid, 95-97% (*m/m*).
- 3.7 Sulfuric acid, 86% (*m/m*).
- 3.8 Chromotropic acid, 5% (*m/v*).

Prepare fresh solution before each determination by dissolving 500 mg sodium chromotropate, $C_{10}H_6Na_2O_8S_2 \cdot 2H_2O$, in 10 mL distilled water

**COMPENDIUM OF INTERNATIONAL METHODS OF ANALYSIS -
OIV**

Total malic acid

3.9 0.5 g DL-malic acid per liter solution

Dissolve 250 g malic acid (C₄H₆O₅) in sodium sulfate solution, 10%, to obtain 500 mL.

4. Procedure

4.1 *Preparation of ion exchanger*

Place a plug of cotton impregnated with distilled water in a 35 x 250 mm glass column. Pour a suspension of the anion exchange resin into the glass column. The level of the liquid should be 50 mm above the top of the resin. Rinse with 1000 mL of distilled water. Wash the column with sodium hydroxide solution, 5%, allow to drain to approximately 2 to 3 mm of the top of the resin and repeat with two further washings of sodium hydroxide, 5%, and leave for one hour. Wash the column with 1000 mL of distilled water. Refill the column with acetic acid, 30%, allow to drain to approximately 2 to 3 mm above the top of the resin and repeat with two further washings of acetic acid, 30%. Leave for at least 24 hours before use. Keep the ion exchange resin in acetic acid, 30%, for the subsequent analysis.

4.2 *Preparation of ion exchange column.*

Place a plug of cotton wool at the bottom of the column measuring 11 x 300 mm above the tap. Pour in the ion exchanger prepared as described above in 4.1 to a height of 10 cm. Open the tap and allow the acetic acid solution, 30%, to drain to approximately 2 to 3 mm above the surface of the exchanger. Wash the exchanger with a 50 mL acetic acid solution, 0.5%.

4.3 *Separation of DL-Malic acid*

Pour onto the column (4.2) 10 mL of wine or must. Allow to drain drop by drop (average rate of one drop per second) and stop the flow 2 to 3 mm from the top of the resin. Wash the column with 50 mL acetic acid, 0.5% (m/v), then with 50 mL of distilled water and allow to drain at the same rate as previously, stopping the flow 2 to 3 mm from the top of the resin.

Elute the acids absorbed on the exchange resin with sodium sulfate solution, 10%, at the same rate as in the previous steps (1 drop/sec). Collect the eluate in a 100 mL volumetric flask. The ion exchange column can be regenerated using the procedure described in 4.1

4.4 *Determination of malic acid*

**COMPENDIUM OF INTERNATIONAL METHODS OF ANALYSIS -
OIV**

Total malic acid

Take two wide necked 30 mL tubes fitted with ground glass stoppers, A and B. In each tube add 1.0 mL of the eluate and 1.0 mL chromotropic acid solution, 5%. Add to tube A 10.0 mL sulfuric acid, 86% (*m/m*), (reference) and to the tube B 10.0 mL sulfuric acid, 96% (*m/m*), (sample). Stopper and shake to homogenize carefully, without wetting the glass stopper. Immerse the tubes in a boiling water bath for exactly 10 min. Cool the tubes in darkness at 20 C for exactly 90 min. Immediately measure the absorbance of tube B relative to the sample tube A at 420 nm in 1 cm cells.

4.5 Plotting the calibration curve

Pipette 5, 10, 15 and 20 mL of the DL-malic acid solution (0.5g/L) into separate 50 mL volumetric flasks. Make up to the mark with sodium sulfate solution, 10%.

These solutions correspond to eluates obtained from wines containing 0.5, 1.0, 1.5 and 2.0 g DL-malic acid per liter.

Continue as indicated in 4.4. The graph of the absorbencies of these solutions verses their malic acid concentration should appear as a straight line passing through the origin.

The intensity of the coloration depends to a large extent on the strength of the sulfuric acid used. It is necessary to check the calibration curve to see if the concentration of the sulfuric acid has changed.

5. Expression of results

Plot the absorbance on calibration graph to obtain the content of DL-malic acid in grams per liter. This content is expressed with 1 decimal.

BIBLIOGRAPHY

**COMPENDIUM OF INTERNATIONAL METHODS OF ANALYSIS -
OIV**

Total malic acid

REINHARD C., KOEDING, G., *Zur Bestimmung der Apfelsäure in Fruchtsäften, Flüssiges Obst.*, 1989, **45**, S, 373 ff.

Method OIV-MA-AS313-11

Type II method

L-Malic acid

(Recueil OIV ed. 1990 REVISED BY OIV/OENO 377/2009)

1. Principle of the method

L-malic acid (L-malate) is oxidized by nicotinamide adenine dinucleotide (NAD) to oxaloacetate in a reaction catalysed by L-malate dehydrogenase (L-MDH).

The equilibrium of the reaction normally lies more strongly in favour of the malate. Removal of the oxaloacetate from the reaction mixture displaces the equilibrium towards the formation of oxaloacetate. In the presence of L-glutamate, the oxaloacetate is transformed into L-aspartate in a reaction catalysed by glutamate oxaloacetate transaminase (GOT):

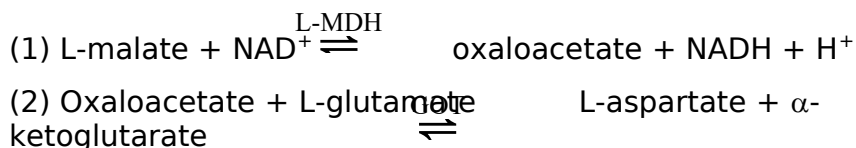

The amount of NADH formed, measured by the increase in absorbance at the wavelength of 340 nm, is proportional to the quantity of L-malate originally present.

2. Apparatus

2.1. A spectrophotometer permitting measurement to be made at 340 nm, the wavelength at which absorption by NADH is at a maximum. Failing that, a spectrophotometer, with a discontinuous spectrum source permitting measurements to be made at 334 or 365 nm, may be used.

Since absolute measurements of absorbance are involved (i.e. calibration curves are not used, but standardization is made by consideration of the extinction coefficient of NADH), the wavelength scales and spectral absorbance of the apparatus must be checked.

2.2. Glass cells with optical path lengths of 1 cm or single-use cells.

2.3. Micropipettes for pipetting sample volumes in the range 0,01 to 2 ml.

3. Reagents

Doubly distilled water

3.1. Buffer solution, pH 10

(glycylglycine 0,6 M; L-glutamate 0,1 M):
dissolve 4,75 g of glycylglycine and 0,88 g of L-glutamic acid in approximately 50 ml of doubly distilled water; adjust the pH to 10 with about 4,6 ml of 10 M sodium hydroxide and make up to 60 ml with doubly distilled water. This solution will remain stable for at least 12 weeks at 4 °C.

3.2. Nicotinamide adenine dinucleotide (NAD) solution, approximately 47×10^{-3} M: dissolve 420 mg of NAD in 12 ml of doubly distilled water. This solution will remain stable for at least four weeks at 4 °C.

3.3. Glutamate oxaloacetate transaminase (GOT) suspension, 2 mg/ml. The suspension remains stable for at least a year at 4 °C.

3.4. L-malate dehydrogenase (L-MDH) solution, 5 mg/ml. This solution remains stable for at least a year at 4 °C.

Note: All the reagents above are available commercially.

4. Preparation of the sample

L-malate determination is normally carried out directly on the wine, without prior removal of pigmentation (colouration) and without dilution provided that the L-malic acid concentration is less than 350 mg/l (measured at 365 mg/l). If this is not so, dilute the wine with doubly distilled water until the L-malate concentration lies between 30 and 350 mg/l (i.e. amount of L-malate in the test sample lies between 3 and 35 µg).

If the malate concentration in the wine is less than 30 mg/l, the volume of the test sample may be increased up to 1 ml. In this case, the volume of water to be added is reduced in such a way that the total volumes in the two cells are equal.

5. Procedure

With the spectrophotometer adjusted to a wavelength of 340 nm, determine the absorbance using the cells having optical paths of 1 cm, with air as the zero absorbance (reference) standard (no cell in the optical path) or with water as the standard. Place the following in the cells having 1 cm optical paths:

**COMPENDIUM OF INTERNATIONAL METHODS OF ANALYSIS - OIV
L-Malic acid**

cell	Reference cell (ml)	Sample (ml)
Solution 3.1	1,00	1,00
Solution 3.2	0,20	0,20
Doubly distilled water	0,90	1,00
Suspension 3.3	0,01	0,01
Sample to be measured	0,10	-

Mix; after about three minutes, measure the absorbances of the solutions in the reference and sample cells (A_1).

Add:

Solution 3.4	0,01 ml
0,01 ml	

Mix; wait for the reaction to be completed (about 5 to 10 minutes) and measure the absorbances of the solutions in the reference and sample cells (A_2).

Calculate the differences ($A_2 - A_1$) in the absorbances of the solutions in the reference and sample cells, ΔA_R and ΔA_S .

Finally, calculate the difference between those differences: $\Delta A = \Delta A_S - \Delta A_R$

Note: The time needed for the completion of enzyme activity can vary from one batch to another. The above value is given only for guidance and it is recommended that it be determined for each batch.

6. Expression of results

L-malic acid concentration is given in grams per litre to one decimal place.

6.1. Method of calculation

The general formula for calculating the concentration in g/l is:

$$C = \frac{V \times PM}{\varepsilon \times \delta \times 1000} \times \Delta A$$

where:

V = volume of test solution in ml (here 2,22 ml)

v = volume of the sample in ml (here 0,1 ml)

M = molecular mass of the substance to be determined (here, for L-malic acid, M=134,09)

δ = optical path in the cell in cm (here, 1 cm)

ε = absorption coefficient of NADH, (at 340 nm

$\varepsilon = 6,3 \text{ m mol}^{-1} \times \text{l} \times \text{cm}^{-1}$),

so that for L-malate:

$$C = 0,473 \times \Delta A \text{ g/l}$$

If the sample was diluted during its preparation, multiply the result by the dilution factor.

Note:

- Measurement at 334 nm, $\varepsilon = 6,2 \text{ (mmole}^{-1} \times \text{l} \times \text{cm}^2)$
 $C = 0,482 \times \Delta A$
- Measurement at 365 nm, $\varepsilon = 6,2 \text{ (mmole}^{-1} \times \text{l} \times \text{cm}^2)$
 $C = 0,876 \times \Delta A$

6.2. Repeatability (r)

$$r = 0,03 + 0,034 x_i$$

x_i is the malic acid concentration in the sample in g/l.

6.3. Reproducibility (R)

$$R = 0,05 + 0,071 x_i$$

x_i is the malic acid concentration in the sample in g/l.

BIBLIOGRAPHY

- BERGMEYER H.U., *Méthodes d'analyse enzymatique*, 2^e éd., Verlag-Chemie Weinheim/Bergstrasse, 1970
- BOERHINGER, Mannheim, *Méthodes d'analyse enzymatique en chimie alimentaire*, documentation technique.
- VAN DEN DRIESSE S. et THYS L., F.C. O.I.V., 1982, n° 755

**COMPENDIUM OF INTERNATIONAL METHODS OF ANALYSIS -
OIV
D-Malic acid**

Method OIV-MA-AS313-12A

Type II method

D-Malic acid

Enzymatic method

(OENO 6/98, revised by OIV/OENO 377/2009)

1. Principle

In the presence of D-malate-dehydrogenase (D-MDH), D-malic acid (D-malate) is oxidized to oxalo-acetate by nicotinamide-adenine-dinucleotide (NAD). The formed oxalo-acetate is transformed into pyruvate and carbon dioxide.

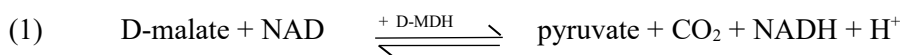

The formation of NADH, measured by the increase of absorbance for 334, 340 or 365 nm wave lengths, is proportional to the quantity of D-malate present.

2. Reagents

Reagents that allow 30 determinations to be made are marketed in a set which includes:

- 1/ Flask 1 containing about 30 ml of solution of Hepes buffer acid [N-(2-hydroxyethyl)piperazine-N'-2-ethane sulfonic] pH = 9.0 and stabilizers;
- 2/ Flask 2 containing about 210 mg of NAD lyophilizate;
- 3/ Flask 3 (three flasks), containing D-MDH lyophilizate, with a titer of about 8 units.

Preparation of the solutions

- 1/ Use the content of flask 1 without dilution. Bring the solution to a temperature of 20-25°C before using it.
- 2/ Dissolve the content of flask 2 in 4 ml of double-distilled water.
- 3/ Dissolve the content of one the flasks 3 in 0,6 ml of double-distilled water.
Bring the solution to a temperature of 20-25 °C before using it.

Stability of the solutions

The contents of flask 1 can be kept for at least one year at + 4°C; solution 2 can be kept about 3 weeks at + 4 °C and 2 months at - 20 °C; solution 3 can be kept 5 days at + 4 °C.

3. Apparatus

- 3.1. Spectrophotometer which is able to measure at the NADH absorption maximum of 340 nm. If this is not available, a spectrophotometer with a discontinuous spectrum source permitting measurements to be made at 334 or 365 nm may be used. Since absolute

**COMPENDIUM OF INTERNATIONAL METHODS OF ANALYSIS -
OIV
D-Malic acid**

absorbance measurements are involved (i.e. calibration curves are not used, but standardization is made by consideration of the extinction coefficient of NADH), the wavelength scales and spectral absorbance of the apparatus must be checked.

3.2. Cells with a 1 cm path of glass or single-use cells.

3.3. Micropipettes capable of pipetting volumes between 0.01 and 2 ml.

4. Preparation of the sample

The analysis of D-malate is generally carried out directly on the wine without preliminary decoloration.

The quantity of D-malate in the cell must be between 2 µg and 50 µg; wine should be diluted so the malate concentration will be between 0.02 and 0.5 g/L or 0.02 and 0.3 g/L depending on the apparatus used.

Dilution table:

Estimated quantity of D-malate/liter	Dilution with water	Dilution factor F
Measured at: 340 or 334 nm 365 nm		
< 0.3 g < 0.5 g	-	1
0.3-3.0 g 0.5-5.0 g	1 + 9	10

5. Procedure

With the spectrophotometer adjusted to a wavelength of 340 nm, determine the absorbance using 1 cm cells, with air as the zero absorbance (reference) standard (no cell in the optical path) or with water as the standard.

Place the following in the 1 cm cells:

	Reference cell (mL)	Sample cell (mL)
Solution 1	1.00 mL	1.00 mL
Solution 2	0.10 mL	0.10 mL
Double-distilled Water	1.80 mL	1.70 mL
Sample	-	0.10 mL

Mix: after approximately 6 minutes, measure the absorbance of the reference and sample solutions (A_1).

Add

	Reference	Sample
Solution 3	0.05 mL	0.05 mL

**COMPENDIUM OF INTERNATIONAL METHODS OF ANALYSIS -
OIV
D-Malic acid**

Mix: wait for the end of the reaction (about 20 min.) and measure the absorbance of the reference and sample solutions (A_2).

Determine the absorbance differences ($A_2 - A_1$) of the control (ΔA_T) and trial (ΔA_D).

Deduct the control absorbance difference from the trial absorbance difference:

$$\Delta A = \Delta A_D - \Delta A_T$$

Comment: the time required for the enzymes' action can vary from one batch to the other. It is given here only as an indication. It is recommended it be determined for each batch.

D-malic acid reacts rapidly. An additional activity of the enzyme also transforms L-tartaric acid even though it is not as rapid. This is the reason why there is a small side reaction which may be corrected by means of extrapolation (see annex 1).

6. Expression of the results

The concentration in milligrams per liter is calculated with the general formula:

$$C = \frac{V \times PM}{\varepsilon \times d \times v} \times \Delta A$$

V = volume of the test in ml (here 2.95 mL)

v = volume of the sample in ml (here 0.1 mL)

PM = molecular mass of the substance to be measured (here, D-malic acid = 134.09)

d = cell path length in cm (here 1 cm)

ε = absorption coefficient of NADH:

at 340 nm = 6.3 (l mmol⁻¹ cm⁻¹)

at 365 nm = 3.4 (l mmol⁻¹ cm⁻¹)

at 334 nm = 6.18 (l mmol⁻¹ cm⁻¹).

If a dilution was made during the preparation of the sample, multiply the result by the dilution factor. The concentration in D-malic acid is given in milligrams per liter (mg/L) without decimal.

7. Accuracy

The details of the interlaboratory trial on the accuracy of the method are summarized in annex 2. The derived values of the interlaboratory study may not be applicable to ranges of

**COMPENDIUM OF INTERNATIONAL METHODS OF ANALYSIS -
OIV
D-Malic acid**

concentration of the analyte and to other matrices other than those given in annex 2.

7.1. Repeatability

The absolute difference between individual results obtained on an identical matter submitted to a trial by an operator using the same apparatus, within the shortest time interval, will not exceed the value of repeatability r in more than 5% of the cases. The value is: $r = 11$ mg/L.

**COMPENDIUM OF INTERNATIONAL METHODS OF ANALYSIS -
OIV
D-Malic acid**

7.2. Reproducibility

The absolute difference between individual results obtained on an identical material submitted to a test in two laboratories will not exceed the value of reproducibility R in more than 5% of the cases. The value is: $R = 20 \text{ mg/L}$.

8. Comments

Taking into account the method's accuracy, the values of D-malic acid less than 50 mg/L must be confirmed by another analytical method using another measuring principle such as that of PRZYBORSKI et al, (1993). Values of D-malic acid less than 100 mg/L must not be interpreted as an addition of D, L-malic acid to wine.

The wine content in the cuvette must not exceed 0.1mL to avoid a possible inhibition of enzymatic activity by polyphenols.

BIBLIOGRAPHY

PRZYBORSKI et al. Mitteilungen Klosterneuburg 43, 1993; 215-218.

ANNEX 1

How to treat side reactions

Side reactions are generally due to secondary reactions of the enzyme, in the presence of other enzymes in the sample's matrix, or the interaction of one or several elements of the matrix with a co-factor of the enzymatic reaction.

With a normal reaction, absorbance reaches a constant value after a certain time, generally between 10 min and 20 min, according to the speed of the specific enzymatic reaction. However, when secondary reactions occur, the absorbance does not reach a constant value, but increases regularly with time; this type of process is commonly called a « side reaction ».

When this problem arises, one should measure the solution's absorbance at regular intervals (2 min to 5 min), after the required time for the standard solution to reach its final absorbance. When the absorbance increases regularly, carry out 5 or 6 measurements, then establish a graphic or calculated extrapolation, in order to obtain what the solution's absorbance would have been when the final enzyme was added (T_0). The difference in extrapolated absorbance at this time ($A_f - A_i$) is used for the calculation of the substrate concentration.

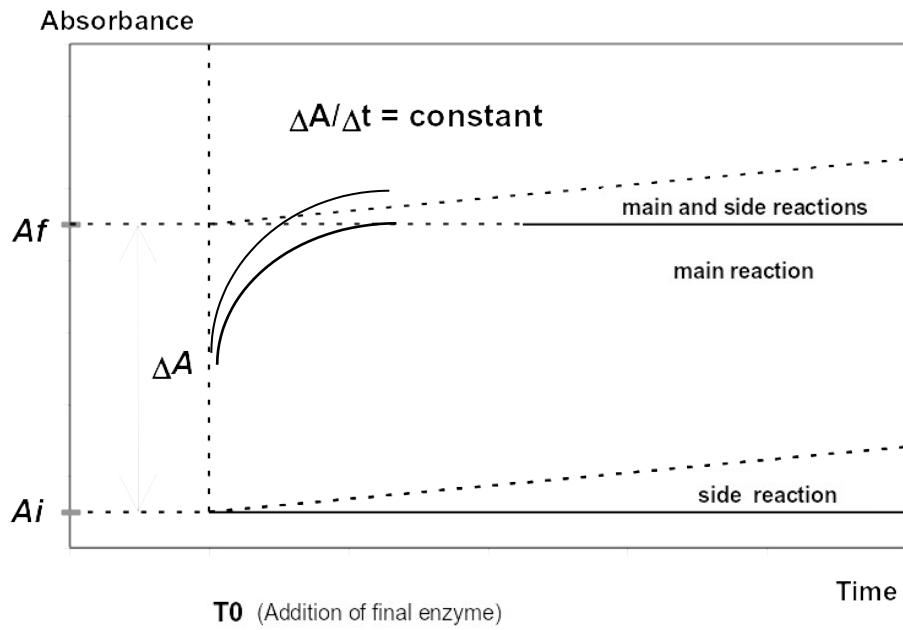

Figure 1: Side reaction

**COMPENDIUM OF INTERNATIONAL METHODS OF ANALYSIS -
OIV
D-Malic acid**

ANNEX 2

Interlaboratory trials statistical results

Year of the interlaboratory trial 1995
 Number of laboratories 8
 Number of samples 5 with addition of D-malic acid

Sample	A	B	C	D	E
Number of laboratories retained after elimination of laboratories presenting aberrant results	7	8	7	8	7
Number of laboratories presenting aberrant results	1	-	1	-	1
Number of accepted results	35	41	35	41	36
Average value(x) (mg/L)	161. 7	65.9	33.1	106. 9	111. 0
Standard deviation of repeatability (s_r) (mg/L)	4.5 3	4.2 4	1.9 3	4.3 6	4.4 7
Relative standard deviation of repeatability (RSD_r) (%)	2.8	6.4	5.8	4.1	4.0 0
Limit of repeatability (r) (mg/L)	12. 7	11. 9	5.4	12. 2	12. 5
Standard deviation of reproducibility (s_R) (mg/L)	9.2 6	7.2 4	5.8 9	6.3 6	6.0 8
Relative standard deviation of reproducibility (RSD_R) (%)	5.7	11	17. 8	5.9	5.5
Limit of reproducibility (R) (mg/L)	25. 9	20. 3	16. 5	17. 8	17. 0

Types of samples:
 A red wine C white wine

**COMPENDIUM OF INTERNATIONAL METHODS OF ANALYSIS -
OIV
D-Malic acid**

B	red wine	D	white wine
		E	white wine

**Determination of d-malic acid in wines at low concentrations
using the enzymatic method**

(Resolution OENO 16/2002, revised by OIV/OENO 377/2009)

1. FIELD OF APPLICATION

The method described is applied to dosage, by the enzymatic means, of malic acid D of wines with contents under 50 mg/l.

2. PRINCIPLE

The principle of the method is based on malic acid D(+) oxidation (D-malate) by nicotinamide-adenine-dinucleotide (NAD) in oxaloacetate that is transformed into pyruvate and carbon dioxide; the formation of NADH, measured by the increase of absorbance in wave length at 340 nm, is proportional to the quantity of D-malate present (principle of the method described for malic acid D determination for concentrations above 50 mg/l), after introducing a quantity of malic acid D of 50 mg/l in a cuvette.

3. REAGENTS

Malic acid D solution of 0.199 g/l, above reagents indicated in the methods described for contents above 50 mg/l.

4. APPARATUS

Apparatus indicated in the method described for concentration above 50 mg/l.

5. SAMPLE PREPARATION

Sample preparation is indicated in the method described for concentrations above 50 mg/l.

6. PROCEDURE

The procedure is indicated in the method described for concentrations above 50 mg/l. (Resolution Oeno 6/98), but with the introduction in the tank of a quantity of malic acid D equivalent to 50 mg/l. (Introduction of 0.025 mL of malic acid D at 0.199 g/l, substituting the equivalent volume of water); the values obtained are decreased by 50 mg/l.

**COMPENDIUM OF INTERNATIONAL METHODS OF ANALYSIS -
OIV**

D-Malic acid - Low concentrations

7. INTERNAL VALIDATION

Summary of the internal validation file on the dosage of malic acid D(+)-
after the addition of 50 mg/l of this isomer

Work level	0 mg of 70 mg of malic acid D(+)-per liter. Within these limits, the method is linear with a correlation coefficiency between 0.990 and 0.994
Setting limit	24.4 mg/l
Detection limit	8.3 mg/l
Sensitivity	0.0015 abs / mg/l
Recovery percent range	87.5 to 115.0% for white wines and 75 to 105% for red wines
Repeatability	=12.4 mg/l for white wines (according to the OIV method =12,5 mg/l) =12.6 mg/l for red wines (according to OIV method=12,7 mg/l)
Percentage standard deviation	4.2% to 7.6% (white wines and red wines)
Intralaboratory variability	CV=7.4% (s=4.4mg/l; X average=59.3 mg/l)

8. BIBLIOGRAPHY

Chretien D., Sudraud P., 1993. Présence naturelle d'acide D(+)-malique dans les
moûts et les vins, *Journal International des Sciences de la Vigne et du Vin*, **27**:
147-149.

Chretien D., Sudraud P., 1994. Présence naturelle d'acide D(+)-malique dans les
moûts et les vins, *Feuille Vert de l'OIV*, 966.

Delfini C., Gaetano G., Gaia P., Piangerelli M.G., Cocito C., 1995. Production of
D(+)-malic acid by wine yeasts, *Rivista de Viticoltura e di Enologia*, **48**: 75-76.

OIV, 1998. *Recueil des méthodes internationales d'analyse des vins et des
moûts. Mise à jour Septembre 1998*. OIV, Paris.

Przyborski H., Wacha C., Bandion F., 1993. Zur bestimmung von D(+)Apfelsäure
in wein, *Mitteilung Klosterneuburg*, **43**: 215-218.

Machado M. and Curvelo-Garcia A.S., 1999; FV.O.I.V. N° 1082, Ref.
2616/220199.

**COMPENDIUM OF INTERNATIONAL METHODS OF ANALYSIS -
OIV
L-ascorbic acid**

Method OIV-MA-AS313-13A

Type IV method

L-Ascorbic acid
(A28, revised by OIV/OENO 377/2009)

1. Principle

The following methods enable the presence of L-ascorbic acid and dehydroascorbic acid in wines or musts to be determined.

Ascorbic acid is converted on activated carbon to dehydroascorbic acid. The latter forms a fluorescent compound on reaction with orthophenylenediamine (OPDA). A control prepared in the presence of boric acid enables spurious fluorescence to be determined (by the formation of a boric acid/dehydroascorbic acid complex). The sample and the control are analyzed fluorometrically and the concentration of dehydroascorbic acid calculated.

2. Method (fluorimetric method)

2.1 Apparatus

2.1.1 Fluorometer.

A spectrofluorometer equipped with a lamp giving a continuous spectrum and using it at minimum power.

The optimum excitation and emission wavelengths for the test are to be determined beforehand and depend on the equipment used. As a guide, the excitation wavelength will be approximately 350 nm and the emission wavelength approximately 430 nm. Cells of 1 cm path length.

2.1.2 Sintered glass filter of porosity 3.

2.1.3 Test tubes (diameter approximately 10 mm).

2.1.4 Stirring rods for test tubes.

2.2 Reagents

2.2.1 Orthophenylenediamine dihydrochloride solution ($C_6H_{10}Cl_2N_2$), 0.02 % (m/v), prepared just before use.

2.2.2 Sodium acetate trihydrate solution ($CH_3COONa \cdot 3H_2O$), 500 g/L.

**COMPENDIUM OF INTERNATIONAL METHODS OF ANALYSIS -
OIV**

L-ascorbic acid

2.2.3 Mixed solution of boric acid and sodium acetate:

Dissolve 3 g of boric acid, (H_3BO_3) in 100 mL of a 500 g/L sodium acetate solution. This solution must be prepared just before use.

2.2.4 Acetic acid solution (CH_3COOH) 56%: glacial acetic acid ($r_{20} = 1.05$ g/mL), diluted to 56% (v/v), pH approximately 1.2.

2.2.5 L-Ascorbic acid standard solution, 1 g/L.

Just before use, dissolve 50 mg of L-ascorbic acid previously dehydrated in a desiccator and protected against light, in 50 mL of acetic acid solution (2.2.4).

2.2.6 Very pure analytical grade activated carbon.

Place 100 g of activated carbon into a 2-liter conical flask and add 500 mL aqueous hydrochloric acid solution, 10% (v/v), ($r_{20} = 1.19$ g/mL). Bring to a boil, and filter through a sintered glass filter of porosity 3. Collect the carbon treated in this way in a 2-liter conical flask. Add 1 liter of water, shake and filter using a sintered glass filter of porosity 3. Repeat this operation two more times. Place the residue in an oven controlled to $115^\circ\text{C} \pm 5^\circ\text{C}$ for 12 hours (or overnight).

2.3 Procedure

2.3.1 Preparation of the sample of wine or must

Take a volume of the wine or must and dilute to 100 mL in a graduated flask with the acetic acid solution, 56% (2.2.4), in order to obtain a solution with an ascorbic acid concentration between 0 and 60 mg/L. Thoroughly mix the contents of the flask by shaking. Add 2 g of activated carbon and allow to stand for 15 minutes, shaking occasionally. Filter using ordinary filter paper, discarding the first few milliliters of filtrate.

Pipette 5 mL of the filtrate into two 100 mL graduated flasks. Add to the first 5 mL of the mixed solution of boric acid and sodium acetate solution (2.2.3) (sample blank) and to the second 5 mL of the sodium acetate solution (2.2.2) (sample). Allow to stand for 15 minutes, stirring occasionally. Make to 100 mL with distilled water. Pipette 2 mL from the contents of each flask into a test tube and add 5 mL of orthophenylenediamine solution. Stir with the stirring rod and

**COMPENDIUM OF INTERNATIONAL METHODS OF ANALYSIS -
OIV
L-ascorbic acid**

allow the reaction proceed for 30 minutes in the dark and then make the spectrofluorometric measurements.

2.3.2. Preparation of the calibration curve.

Into three 100 mL graduated flasks pipette 2, 4, and 6 mL respectively of the standard ascorbic acid solution (2.2.5), make to 100 mL with acetic acid solution and thoroughly mix by stirring. The standard solutions prepared in this way contain 2, 4 and 6 mg per 100 mL of L-ascorbic acid respectively.

Add 2 g of activated carbon to each of the flasks and allow to stand for 15 minutes, stirring occasionally. Filter through ordinary filter paper, discarding the first few milliliters. Pipette 5 mL of each filtrate into three 100 mL graduated flasks (first series). Repeat the operation and obtain a second series of three graduated flasks. To each of the flasks in the first series (corresponding to the blank test) add 5 mL of the mixed solution of boric acid and sodium acetate (2.2.3), and to each of the flasks in the second series add 5 mL of the sodium acetate solution (2.2.2). Let stand for 15 minutes, stirring occasionally. Make up to 100 mL with distilled water. Take 2 mL of the contents of each flask; add 5 mL of orthophenylenediamine solution. Stir and allow the reaction to proceed for 30 minutes in the dark and then make the spectrofluorometric measurements.

2.3.3 Fluorometric determination

Set the zero on the scale of measurement using the corresponding control test sample for each solution. Measure the intensity of the fluorescence for each solution over the calibration range and for the solution to be determined. Plot the calibration curve, which should be a straight line passing through the origin. From the graph determine the concentration C of ascorbic acid and dehydroascorbic acid in the solution analyzed.

2.4 *Expression of results*

The concentration of L-ascorbic acid and the dehydroascorbic acid in the wine in milligrams per liter is given by:

$$C \times F$$

where F is the dilution factor.

BIBLIOGRAPHY

AFNOR standard, 76-107, ARNOR, Tour Europe, Paris.
PROM T., *F.V., O.I.V.*, 1984, n° 788.

**COMPENDIUM OF INTERNATIONAL METHODS OF ANALYSIS -
OIV
L-ascorbic acid**

Method OIV-AS313-13B

Type IV method

L-Ascorbic acid
(Resolution OIV/OENO 377/2009)

WITHDRAWN

OIV-MA-AS313-13B : R2009

Method OIV-MA-AS313-14A
method

Type IV

Sorbic acid
(A30, revised by OIV/OENO 377/2009)

1. Principle of Method

Determination using ultraviolet absorption spectrophotometry

Sorbic acid (*trans, trans*, 2,4-hexadienoic acid) extracted by steam distillation is determined in wine distillate by ultraviolet absorption spectrophotometry. Substances that interfere with the measure of absorption in ultraviolet are removed by evaporation to dryness using a slightly alkaline calcium hydroxide solution. Samples with less than 20 mg/L are confirmed using thin layer chromatography (sensitivity: 1 mg/L).

2. Determination by ultraviolet absorption spectrophotometry

2.1 *Apparatus*

2.1.1 Steam distillation apparatus (see chapter "Volatile Acidity")

2.1.2 Water bath 100 °C

2.1.3 Spectrophotometer allowing absorbance measurements to be made at a wavelength of 256 nm and having a quartz cell with a 1 cm optical path

2.2 *Reagents*

2.2.1 Crystalline tartaric acid

2.2.2 Calcium hydroxide solution, approx. 0.02 M

2.2.3 Sorbic acid standard solution, 20 mg/L:

Dissolve 20 mg sorbic acid in approximately 2 mL 0.1 M sodium hydroxide solution. Pour into a 1 L volumetric flask, and make up to volume with water. Alternatively dissolve 26.8 mg of potassium sorbate, C₆H₇KO₂, in water and make up to 1 L with water.

2.3 *Procedure*

**COMPENDIUM OF INTERNATIONAL METHODS OF ANALYSIS -
OIV
Sorbic acid**

2.3.1 Distillation

Place 10 mL of wine in the bubbler of the steam distillation apparatus and add about 1 g tartaric acid. Collect 250 mL of distillate.

2.3.2 Preparation of the calibration curve

Prepare, by dilution of the standard solution (2.2.3) with water, four dilute standard solutions containing 0.5, 1.0, 2.5 and 5 mg of sorbic acid per liter. Measure their absorbance with the spectrophotometer at 256 nm using distilled water as a blank. Plot a curve showing the variation of absorbance as a function of concentration. The relationship is linear.

2.3.3 Determination

Place 5 mL of the distillate in an evaporating dish of 55 mm diameter, add 1 mL of calcium hydroxide solution (2.2.2). Evaporate to dryness on a boiling water bath. Dissolve the residue in several mL of distilled water, transfer completely to a 20 mL volumetric flask and bring to volume with the rinsing water. Measure the absorbance at 256 nm using a solution obtained by diluting 1 mL of calcium hydroxide solution to 20 mL with water as the blank. Plot the value of the absorbance on the calibration curve and from this interpolate the concentration *C* of sorbic acid in the solution.

Note: In this method the loss due to evaporation is negligible and the absorbance is measured on the treated distillate diluted 1/4 with distilled water.

2.4 *Expression of results*

2.4.1 Calculation

The sorbic acid concentration in the wine expressed in mg/L is given by:

$$100 \times C$$

C = concentration of sorbic acid in the solution obtained in 2.3.3 expressed in mg/L.

**COMPENDIUM OF INTERNATIONAL METHODS OF ANALYSIS -
OIV
Sorbic acid**

BIBLIOGRAPHY

- JAULMES P., MESTRES R. & MANDROU B., *Ann. Fals. Exp. Chim.*,
n° spécial, réunion de Marseille, 1961, 111-116.
MANDROU, B., BRUN, S. & ROUX E., *Ann. Fals. Exp. Chim.*, 1975,
725, 29-48.
CHRETIEN D., PEREZ L. & SUDRAUD P., *F.V., O.I.V.*, 1980, n° 720

Method OIV-MA-AS313-14B
method

Sorbic acid
(A30, revised by OIV/OENO 377/2009)

1. Principle of Methods

Determination by gas chromatography

Sorbic acid extracted in diethyl ether is determined by gas chromatography using an internal standard.

2. Determination by gas chromatography

2.1 Apparatus

2.1.1. Gas chromatograph fitted with a flame ionization detector and a stainless steel column (4 m x 1/8 inch) previously treated with dimethyldichlorosilane and packed with a stationary phase consisting of a mixture of diethyleneglycol succinate, 5%, and phosphoric acid, 1%, (DEGS - H₃PO₄), or of a mixture of diethyleneglycol adipate, 7%, and phosphoric acid, 1%, (DEGA - H₃PO₄) bonded on Gaschrom Q 80 - 100 mesh.

Treatment of column with dimethyldichlorosilane (DMDCS): pass a solution containing 2 to 3 g of (DMDCS) in toluene through the column.

Immediately wash with methanol, followed by nitrogen and then wash with hexane followed by more nitrogen. The column is now ready to be packed.

Operating conditions:

- Oven temperature: 175 °C
- Temperature of the injector and detector: 230 °C.
- Carrier gas: nitrogen (flow rate = 200 mL/min)

Note: Other types of columns can also give a good separation, particularly capillary columns (e.g. FFAP). The working method described below is given as an example.

**COMPENDIUM OF INTERNATIONAL METHODS OF ANALYSIS -
OIV
Sorbic acid**

2.1.2 Microsyringe, 10 μL capacity graduated in 0.1 μL .

2.2 Reagents

2.2.1 Diethyl ether distilled just before use

2.2.2 Internal standard: solution of undecanoic acid, $\text{C}_{11}\text{H}_{22}\text{O}_2$, 1 g/L in ethanol, 95% (v/v)

2.2.3. Aqueous solution of sulfuric acid, H_2SO_4 , ($\rho_{20} = 1.84$ g/mL) diluted 1/3 (v/v)

2.3 Procedure

2.3.1 Preparation of sample to be analyzed

Into a glass test tube of approximately 40 mL capacity and fitted with a ground glass stopper, place 20 mL of wine, 2 mL of the internal standard (2.2.2) and 1 mL of dilute sulfuric acid. After mixing the solution by repeatedly turning the tube over, add 10 mL of diethyl ether (2.2.1). Extract the sorbic acid into the organic phase by shaking the tube for five minutes. Allow to settle.

2.3.2 Preparation of the spiked sample

Select a wine for which the chromatogram of the ether extract shows no peak corresponding to the elution of sorbic acid. Fortify this wine with sorbic acid at a concentration of 100 mg/L. Treat 20 mL of the sample prepared in this way according to the procedure described in 2.3.1.

2.3.3. Chromatography

Inject 2 μL of the ether-extract phase obtained in 2.3.2, into the chromatograph using a microsyringe, followed by 2 μL of the ether-extracted phase obtained in 2.3.1.

Record the respective chromatograms: check the identity of the respective retention times of the sorbic acid and the internal standard. Measure the height (or area) of each of the recorded peaks.

2.4 Expression of results

2.4.1 Calculation

**COMPENDIUM OF INTERNATIONAL METHODS OF ANALYSIS -
OIV
Sorbic acid**

The concentration of sorbic acid in the analyzed wine, expressed in mg/L, is given by:

$$100 \times \frac{h}{H} \times \frac{I}{i}$$

where

H = height of the sorbic acid peak in the spiked solution

h = height of the sorbic acid peak in the sample for analysis

I = height of the internal standard peak in the spiked solution

i = height of the internal standard peak in the sample for analysis

Note: The sorbic acid concentration may be determined in the same way from measurements of the respective peak areas.

BIBLIOGRAPHY

JAULMES P., MESTRES R. & MANDROU B., *Ann. Fals. Exp. Chim.*, n° spécial, réunion de Marseille, 1961, 111-116.

MANDROU, B., BRUN, S. & ROUX E., *Ann. Fals. Exp. Chim.*, 1975, 725, 29-48.

CHRETIEN D., PEREZ L. & SUDRAUD P., *F.V., O.I.V.*, 1980, n° 720

Method OIV-MA-AS313-14C
method

Sorbic acid
(A30, revised by OIV/OENO 377/2009)

1. Principle of Methods

Identification of traces by thin-layer chromatography

Sorbic acid extracted in ethyl ether is separated by thin layer chromatography and its concentration is evaluated semi-quantitatively.

2. Identification of traces of sorbic acid by thin layer chromatography

2.1 Apparatus

2.1.1 Precoated 20 x 20 cm plates for thin layer chromatography coated with polyamide gel (0.15 mm thick) with the addition of a fluorescence indicator

2.1.2 Chamber for thin layer chromatography

2.1.3 Micropipette or microsyringe for delivering volumes of 5 μL to within $\pm 0.1 \mu\text{L}$

2.1.4 Ultraviolet lamp (254 nm)

2.2. Reagents

2.2.1 Diethyl ether, $(\text{C}_2\text{H}_5)_2\text{O}$

2.2.2 Aqueous sulfuric acid solution: sulfuric acid ($\rho_{20} = 1.84 \text{ g/mL}$), diluted 1/3 (v/v)

2.2.3 Standard solution of sorbic acid, approximately 20 mg/L, in a 10% (v/v) ethanol/water mixture.

4.2.4 Mobile phase: hexane + pentane + acetic acid (20:20:3).

4.2.5

2.3 Procedure

2.3.1 Preparation of sample to be analyzed

**COMPENDIUM OF INTERNATIONAL METHODS OF ANALYSIS -
OIV
Sorbic acid**

Into a glass test tube of approximately 25 mL capacity and fitted with a ground glass stopper, place 10 mL of wine; add 1 mL of dilute sulfuric acid (2.2.2) and 5 mL of diethyl ether (2.2.1). Mix by repeatedly inverting the tube. Allow to settle.

2.3.2 Preparation of dilute standard solutions

Prepare five dilute standard solutions from the solution in 2.2.3. containing 2, 4, 6, 8 and 10 mg sorbic acid per liter.

2.3.3 Chromatography

Using a microsyringe or micropipette, deposit 5 μL of the ether-extracted phase obtained in 2.3.1 and 5 μL each of the dilute standard solutions (2.3.2) at points 2 cm from the lower edge of the plate and 2 cm apart from each other.

Place the mobile phase in the chromatograph tank to a height of about 0.5 cm and allow the atmosphere in the tank to become saturated with solvent vapor. Place the plate in the tank. Allow the chromatogram to develop over 12 to 15 cm (development time approximately 30 minutes). Dry the plate in a current of cool air. Examine the chromatogram under a 254 nm ultraviolet lamp.

The spots indicating the presence of sorbic acid will appear dark violet against the yellow fluorescent background of the plate.

2.4 *Expression of the results*

A comparison of the intensities of the spots produced by the test sample and by the standard solutions will enable a semi-quantitative assessment of a sorbic acid concentration between 2 and 10 mg/L. A concentration equal to 1 mg/L may be determined by using a 10 μL sample size.

Concentrations above 10 mg/L may be determined using a sample volume of less than 5 μL (measured out using a microsyringe).

BIBLIOGRAPHY

**COMPENDIUM OF INTERNATIONAL METHODS OF ANALYSIS -
OIV
Sorbic acid**

JALMES P., MESTRES R. & MANDROU B., *Ann. Fals. Exp. Chim.*,
n° spécial, réunion de Marseille, 1961, 111-116.
MANDROU, B., BRUN, S. & ROUX E., *Ann. Fals. Exp. Chim.*, 1975,
725, 29-48.
CHRETIEN D., PEREZ L. & SUDRAUD P., *F.V., O.I.V.*, 1980, n° 720

pH
(A31, OIV-OENO 438-2011)

1. Principle

The difference in potential between two electrodes immersed in the liquid under test is measured. One of these two electrodes has a potential that is a function of the pH of the liquid, while the other has a fixed and known potential and constitutes the reference electrode.

2. Apparatus

2.1 pH meter with a scale calibrated in pH units and enabling measurements to be made to at least ± 0.01 pH units.

2.2 Electrodes:

- glass electrode, kept in distilled water;
- calomel-saturated potassium chloride reference electrode, kept in a saturated solution of potassium chloride; or,
- a combined electrode, kept in distilled water.

3. Reagents

- Buffer solutions:

- Saturated potassium hydrogen tartrate solution, containing 5.7 g/L potassium hydrogen tartrate ($\text{CO}_2\text{HC}_2\text{H}_4\text{O}_2\text{CO}_2\text{K}$) at 20°C. (This solution may be kept for up to two months by adding 0.1 g of thymol per 200 mL.)

} pH 3.57 at 20 °C
 3.56 at 25 °C
 3.55 at 30 °C

- Potassium hydrogen phthalate solution, 0.05 M, containing 10.211 g/L potassium hydrogen phthalate, $\text{CO}_2\text{HC}_6\text{H}_4\text{CO}_2\text{K}$, at 20°C. (This solution may be kept for up to two months.)

} 3.999 at 15 °C
 4.003 at 20 °C
 4.008 at 25 °C

4.015 at 30 °C

COMPENDIUM OF INTERNATIONAL METHODS OF ANALYSIS-OIV
pH

Solution containing:

potassium *di*-hydrogen phosphate, KH_2PO_4
3.402 g

di-potassium hydrogen phosphate, K_2HPO_4
4.354 g

water to/..... 1 litre

(This solution may be kept for up to two months)

} 6.90 at 15 °C
6.88 at 20 °C
6.86 at 25 °C
6.85 at 30 °C

Note: commercial reference buffer solutions traceable to the SI may be used.

For example: pH 1.679 ± 0.01 at 25°C

pH 4.005 ± 0.01 at 25°C

pH 7.000 ± 0.01 at 25°C

4. Procedure

4.1 Zeroing of the apparatus

Zeroing is carried out before any measurement is made, according to the instructions provided with the apparatus used.

4.2 Calibration of the pH meter

The pH meter must be calibrated at 20°C using standard buffer solutions connected to the SI. The pH values selected must encompass the range of values that may be encountered in musts and wines. If the pH meter used is not compatible with calibration at sufficiently low values, a verification using a standard buffer solution linked to the SI and which has a pH value close to the values encountered in the musts and wines may be used.

4.3 Determination

Dip the electrode into the sample to be analyzed, the temperature of which should be between 20 and 25°C and as

close as possible to 20°C. Read the pH value directly off the scale.

Carry out at least two determinations on the same sample.

The final result is taken to be the arithmetic mean of two determinations.

5. Expression of results

The pH of the must or the wine is reported to two decimal places.

Method OIV-MA-AS313-16

Type IV method

**Determination of organic acids and mineral anions in wines
by ionic chromatography**
(OENO 23/2004; OIV/OENO 377/2009)

Preamble

The development of high performance ionic chromatography in laboratories has enabled the study the determination of organic acids and mineral anions in alcoholic and non alcoholic beverages by this technique.

Particularly concerning the analysis of wines, the results of intercomparison test trials and the measurements of recovery rates have enabled us to validate an analytical methodology.

The major interest of this method is that the ion exchange columns allow the separation of most organic acids and anions, and the detection by conductivity frees the analysis from interferences due to the presence of phenolic compounds. This type of interference is very notable in chromatographic methods that include detection in ultra-violet radiation at 210 nm.

1 - OBJECT AND FIELD OF APPLICATION

This method for mineral anions and organic acids by ionic chromatography is applicable to alcoholic beverages (wines, wine spirits and liqueurs). It enables the determination of organic acids in the ranges of concentration listed in table 1; these concentrations are obtained by diluting samples.

Table 1: range of concentration of anions for their analysis by ionic chromatography

Sulfate	0.1 to 10	mg/l
Ortho-phosphate	0.2 to 10	mg/l
Malic acid	1 to 20	mg/l
Tartaric acid	1 to 20	mg/l
Citric acid	1 to 20	mg/l
Isocitric acid	0.5 to 5	mg/l

The ranges of the above-mentioned work are given as an example. They include the methods of calibration commonly practiced and are therefore adaptable

**COMPENDIUM OF INTERNATIONAL ANALYSIS OF METHODS -
OIV
Organic acids**

according to the type of apparatus used (nature of column, sensitivity of the detector, etc.) and procedure (volume of sample injected, dilution, etc.).

2- PRINCIPLE

Separation of mineral and organic anions on an ion exchanger resin.

Detection by conductimetry.

Identification after the retention time and quantification using the calibration curve.

3 - REAGENTS

All the reagents used during the analysis must be of analytical quality. The water used for the preparation of solutions must be distilled or deionised water of a conductivity lower than 0.06 μS , free from anions determined at thresholds compatible with the detection limits of the apparatus used.

3.1 Eluant

The composition of the eluant depends on the nature of the separation column and the nature of the sample to be analysed. Nevertheless it is always prepared using aqueous solutions of sodium hydroxide.

The performances of the chromatographic analysis are alternated by carbonation of the sodium hydroxide solution; consequently, the mobile phase flasks are swept with helium before adding sodium hydroxide and all precautions should be taken in order to avoid contaminating them with room air.

Lastly, commercial concentrated sodium hydroxide solutions will be used.

Remark

The table in chapter 9 mentions the main interferences susceptible of being present in the samples.

It is therefore necessary to know beforehand if they coelute with the ions to be determined and if they are present at such a concentration that the analysis is disrupted.

Fermented drinks contain succinic acid which can interfere with the malic acid determination. To this effect, it is necessary to add methanol to the eluant in order to improve the resolution of the column for these two substances (20% of methanol).

**COMPENDIUM OF INTERNATIONAL ANALYSIS OF METHODS -
OIV
Organic acids**

3.2 Calibration reference solutions

Prepare calibration reference solutions of precise concentrations close to those indicated in the following table. Dissolve in water, quantities of salts or corresponding acids in 1000 ml volumetric flasks. (Table 2)

Table 2: Concentration of anions determined in calibration reference solutions

Anions and acids	Compounds weighed	Concentration final (mg/l)	Quantity weighed (mg)
Sulphate	Na ₂ SO ₄	500	739.5
Orthophosphate	KH ₂ PO ₄	700	1003.1
Malic acid	Malic acid	1000	1000.0
Tartaric acid	Tartaric acid	1000	1000.0
Citric acid	Citric acid, H ₂ O	1000	1093.8
Isocitric acid	Isocitrate 3Na, 2H ₂ O	400	612.4

Remark

The laboratory must take the necessary precautions regarding the hygroscopic character of certain salts.

3.3 Calibration solutions

The calibration solutions are obtained by diluting the reference solutions of each ion or acid in water.

These solutions should contain all the ions or acids determined in a range of concentrations covering those corresponding to the samples to be analysed. They must be prepared the day of their use.

At least two calibration solutions and a blank must be analysed so as to establish, for each substance, the calibration curves using three points (0, maximum semi-concentration, maximum concentration).

Remark

Table 1 gives indications on the maximum concentrations of anions and acids in calibration solutions but the performances of the chromatographic columns are better with very diluted solutions.

So the best adequation possible between the performances of the column and the level of dilution of the samples should be looked for.

**COMPENDIUM OF INTERNATIONAL ANALYSIS OF METHODS -
OIV
Organic acids**

In general, the sample is diluted between 50 and 200 times maximum except for particular cases.

For prolonging the life span of the dilution solutions, it is preferable to prepare them in a water/methanol solution (80/20).

4 - APPARATUS

4.1 Instrument system for ionic chromatography including:

4.1.1 Eluant reservoir(s)

4.1.2 Constant-stroke pump, without pulsing action

4.1.3 Injector, either manual or automatic with a loop sampling valve (for example 25 or 50 μ l).

4.1.4 Separation columns

System made up of an anion exchanger column of controlled performance, possibly a precolumn of the same type as the main column. For example, it is possible to use the AS11 columns and DIONEX® AG11 precolumn.

4.1.5 Detection system

Circulation conductivity cell of very low volume connected to a conductivity meter with several ranges of sensitivity.

In order to lower the conductivity of the eluant, a chemical suppression mechanism, a cation exchanger is installed in front of the conductivity cell.

4.1.6 Recorder, integrator or other device for the treatment of signals.

4.2 Precise balance to 1 mg

4.3 Volumetric flasks from 10 to 1000 ml

4.4 Calibrated pipettes from 1 to 50 ml

4.5 Filtrating membranes with an average pore diameter of 0.45 μ m.

5 - SAMPLING

The samples are diluted while taking into account the mineral anions and organic acids that are to be determined.

If their concentration is very variable in the sample, two levels of dilution will be necessary in order to respect the ranges of concentration covered by the calibration solutions.

6 - PROCEDURE

Turn on the apparatus by following the manufacturer's instructions.

Adjust the pumping (eluant flux) and detection conditions so as to obtain good separations of the peaks in the range of concentrations of ions to be analysed.

Allow the system to balance until a stable base line is obtained.

**COMPENDIUM OF INTERNATIONAL ANALYSIS OF METHODS -
OIV
Organic acids**

6.1 Calibration

Prepare the calibration solutions as indicated in 3.3.

Inject the calibration solutions so that the volume injected is at least 5 times that of the sampling loop to allow the rinsing of the system.

Trace the calibration curves for each ion. These must normally be straight.

6.2 Blank trial

Inject the water used for the preparation of the calibration solutions and samples.

Control the absence of parasite peaks and quantify the mineral anions present (chloride, sulphate, etc.).

6.3 Analysis

Dilute the sample possibly at two different levels as indicated in 5, so that the anions and acids to be determined are present in the range of concentrations of the calibration solutions.

Filter the diluted sample on a filtrating membrane (4.5) before injection.

Then proceed as for the calibration (6.1).

7 - REPEATABILITY, REPRODUCIBILITY

An interlaboratory circuit tested this method, but this does not constitute a formal validation according to The OIV protocol (Oeno 6/99).

A repeatability limit and a reproducibility limit for the determination of each ion in wine were calculated according to the ISO 5725 standard.

Each analysis was repeated 3 times.

Number of participating laboratories: 11; the results were as follows:

White wine

	No labs	Average (mg/l)	Repeatability (mg/l)	Reproducibility (mg/l)
Malic acid	11/11	2745	110	559
Citric acid	9/11	124	13	37
Tartaric acid	10/11	2001	96	527
Sulphate	10/11	253	15	43
O.phosphate	9/11	57	5	18

**COMPENDIUM OF INTERNATIONAL ANALYSIS OF METHODS -
OIV
Organic acids**

Red wine

	No labs	Average (mg/l)	Repeatability (mg/l)	Reproducibility (mg/l)
Malic acid	8/11	128	16	99
Citric acid	8/10	117	8	44
Tartaric acid	9/11	2154	48	393
Sulphate	10/11	324	17	85
O.phosphate	10/11	269	38	46

8 – CALCULATION OF RECOVERY RATE

The supplemented sample is a white wine.

Determination	No labs	Concentration initial (mg/l)	Real addition (mg/l)	Measured addition (mg/l)	Recovery rate (%)
Citric acid	11/11	122	25.8	24.2	93.8
Malic acid	11/11	2746	600	577	96.2
Tartaric acid	11/11	2018	401	366	91.3

9 - RISKS OF INTERFERENCES

Any substance whose retention time coincides with that of one of the ions analysed can constitute an interference.

The most common interference include the following:

Anions or	Interferents acids
Nitrate	bromide
Sulphate	oxalate, maleate
Orthophosphate	phtalate
Malic acid	Succinic acid, Citramalic acid
Tartric acid	Malonic acid
Citric acid	-
Isocitric acid	-

Remark: The addition of methanol in the mobile phase can resolve certain analytical problems.

**Determination of shikimic acid in wine
by HPLC and UV-detection
(OENO 33/2004; OIV/OENO 377/2009)**

1. INTRODUCTION

Shikimic acid (3,4,5-Trihydroxy-1-cyclohexene-1-carboxylic acid) is biosynthetically synthesized from chnic acid by dehydration and plays a major role as a precursor of phenylalanine, tyrosine, tryptophan and plant alkaloids [1]. As a minor carboxylic acid shikimic acid is naturally found in a wide range of fruits [2].

Member states are encouraged to continue research in this area to avoid any non scientific evaluation of the results.

This method has been validated in an international collaborative study via the analyses of wine samples with naturally occurring amounts of shikimic acid ranging from about 10 to 150 mg/l. The trueness has been proved by an interlaboratory comparison using HPLC and GC/FID and GC/MS respectively [3].

2. SCOPE

This paper specifies an isocratic routine method for the quantitative determination of shikimic acid in red, rosé and white wine (included sparkling and special wines) at concentration levels ranging from 1 mg/l up to 300 mg/l by high performance liquid chromatography. When the method is applied to sparkling wine the samples must be previously degassed (for instance by sonication).

3. PRINCIPLE

Shikimic acid is determined directly without previous sample preparation by high performance liquid chromatography using a coupled column system. In a first step the organic acids in wine are pre-separated with a C₁₈ reversed phase column followed by a cation exchange column at 65 °C performing the final separation. By using slightly acidified water as elution solvent a baseline resolution of shikimic acid is achieved without any interferences from the wine matrix . Due to the double bond within the cyclohexene ring

**COMPENDIUM OF INTERNATIONAL ANALYSIS OF METHODS -
OIV
Shikimic acid**

system shikimic acid has a strong absorption and can therefore be detected easily with an UV-detector at its absorption maximum at 210 nm.

4. REAGENTS AND MATERIALS

- 4.1 Shikimic acid (CAS 138-59-0) , at least 98 % pure
- 4.2 Sulfuric acid 0,5 M
- 4.3 Bidestilled water
- 4.4 Preparation of the elution solvent (0,01 M H₂SO₄)
Pipette 20 ml of the 1 N sulfuric acid (4.2) to a 1000 ml volumetric flask, fill up with bidestilled water (4.3) to about 900 ml, shake and adjust to 1000 ml. Filter the elution solvent with a filter of a pore size less than or equal to 0,45 µm and degas.
- 4.5 Preparation of stock standard solution (500 mg/l shikimic acid)
Weigh exactly 50 mg shikimic acid (4.1), transfer them without loss to a 100 ml volumetric flask, fill up with bidestilled water (4.3) to about 90 ml, shake and adjust to 100 ml. At -18 °C the stock standard solution can be stored for months.
- 4.6 Preparation of working standard solutions (5 , 25 , 50 , 100, 150 mg/l shikimic acid) Dilute stock solution 500 mg/l (4.5) appropriately with bidestilled water (4.3) to give five working standards of 5 , 25 , 50 , 100, 150 mg/l shikimic acid. Prepare working standard solutions daily.

5. APPARATUS

Usual laboratory equipment, in particular, the following:

- 5.1 HPLC system capable of achieving baseline resolution of shikimic acid
 - 5.1.1 High-performance liquid chromatograph with a six-way injection valve fitted with a 5 µl loop or any other device, either automatic or manual, for a reliable injection of microvolumes
 - 5.1.2 Isocratic pumping system enabling one to achieve and maintain a constant or programmed rate of flow with great precision.
 - 5.1.3 Column heater enabling one to heat a 300 mm column to 65 °C
 - 5.1.4 UV-VIS detector with a flow cell and wavelength set of 210 nm
 - 5.1.5 Computational integrator or other data collection system
- 5.2 HPLC column system of stainless steel
 - 5.2.1 Guard column

It is recommended that a suitable pre-column is attached in front of the analytical column system.

5.2.2 Analytical column system

1. Reversed Phase Column (ambient)

Material: stainless steel

Internal diameter: 4 - 4,6 mm

Length : 200 - 250 mm

Stationary phase: spherical C₁₈ reversed phase material, particles 5µ in diameter^{*)}

coupled with

2. Cation exchange column (heated up to 65 ° C)

Material: stainless steel

Internal diameter: 4 - 7,8 mm

Length : 300 mm

Stationary phase: Sulfonated styrene-divinylbenzene gel type resin (S-DVB), containing a hydrogen packing, cross linked 8 %^{**)}

6. SAMPLING

Clear samples are filled directly into sample vials and supplied to chromatography without any sample preparation. Cloudy wine samples are filtered through a 0,45 µm membrane filter before injection, while the first fractions of filtrates are rejected.

7. PROCEDURE

7.1 Operating conditions of HPLC analysis

Inject 5 µL of wine into the chromatographic apparatus by full loop injection system.

Flow rate: 0,4 ml/min (if internal diameter of the cation exchange column is 4 mm)

0,6 ml/min (if internal diameter of the cation exchange column is 7,8 mm)

Mobile Phase: 0,01 M H₂SO₄

Column heater for cation exchange column: 65 °

Run time: 40 min

*) Lichrospher™ 100 RP-18 , Hypersil™-ODS or Omnicrom™ YMC-ODS-A are examples of suitable columns available commercially

* *) Aminex™ HPX 87-H or Rezex™ ROA-Organic Acid are examples of suitable columns available commercially

**COMPENDIUM OF INTERNATIONAL ANALYSIS OF METHODS -
OIV
Shikimic acid**

Equilibration time: 20 min (to ensure that all substances from the wine matrix are completely eluted)

Detection wavelength: 210 nm

Injection volume: 5 μ L

***Note:** Due to the different separation properties of various columns and different dead volumes of various HPLC-equipments the absolute retention time (min) for the shikimic acid peak may vary more or less significantly. Even though shikimic acid can be identified easily by calculating the a relative retention (r) related to a reference peak, here tartaric acid, a major organic acid naturally occurring in wine and the first and dominant peak in the chromatogram . By trying different C₁₈ reversed phase columns and various cation exchange columns a relative retention (r) of 1.33 (\pm 0.2) has been calculated.*

7.2. Detection limit

The detection limit of this method calculated according to the OIV protocol was estimated to 1 mg/l.

8. CALCULATION

Prepare a 5-point calibration curve from the working standard solutions (4.6).

Following the method of external standard the quantification of shikimic acid is performed by measuring the peak areas at shikimic acid retention time and comparing them with the relevant calibration curve. The results are expressed in mg/l shikimic acid at 1 decimal place.

9. PRECISION

The method was tested in a collaborative study with 19 international laboratories participating. Design and assessment followed O.I.V. Resolution Oeno 8/2000 "Validation Protocol of Analytical Methods". The study included 5 different samples of red and white wines. The samples covered concentration levels from 10 to 120 mg/l (see Annex 3).

The Standard Deviations of Repeatability and Reproducibility correlated with the shikimic acid concentration (see Annex 2). The actual performance parameters can be calculated by

**COMPENDIUM OF INTERNATIONAL ANALYSIS OF METHODS -
OIV
Shikimic acid**

$$s_r = 0,0146 \cdot x + 0,2716$$
$$s_R = 0,0286 \cdot x + 1,4883$$

x: shikimic acid
concentration (mg/l)

Example:

shikimic acid: 50 mg/l

$$s_r = \pm 1,0 \text{ mg/l}$$
$$s_R = \pm 2,92 \text{ mg/l}$$

10. ANNEX

A typical separation of shikimic acid from other organic acids in wine is given in the Annex 1.

The relationship of shikimic acid concentration and the standard deviation of repeatability and reproducibility is given in Annex 2.

The statistical data derived from the results of the interlaboratory study is given in Annex 3.

11. BIBLIOGRAPHY

- [1] Römpf Lexikon Chemie-Version 2.0, Stuttgart/New York, Georg Thieme Verlag 1999
- [2] Wallrauch S., Flüssiges Obst 3, 107 – 113 (1999)
- [3] 44th Session SCMA, 23-26 march 2004, Comparison of HPLC-, GC- and GC-MS-Determination of Shikimic Acid in Wine, FV 1193

**COMPENDIUM OF INTERNATIONAL ANALYSIS OF METHODS -
OIV
Shikimic acid**

Annex 1: Chromatogram of organic acids in wine

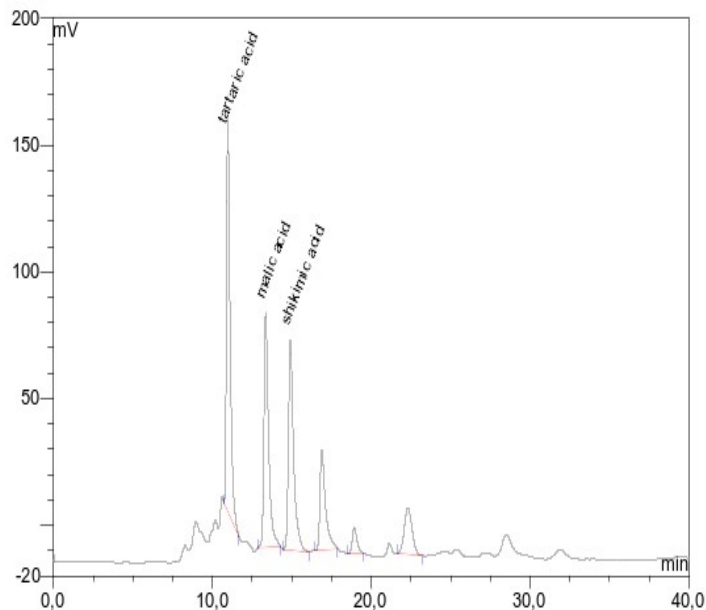

Annex 2: Correlation of shikimic acid concentration and standard deviation of repeatability and reproducibility respectively

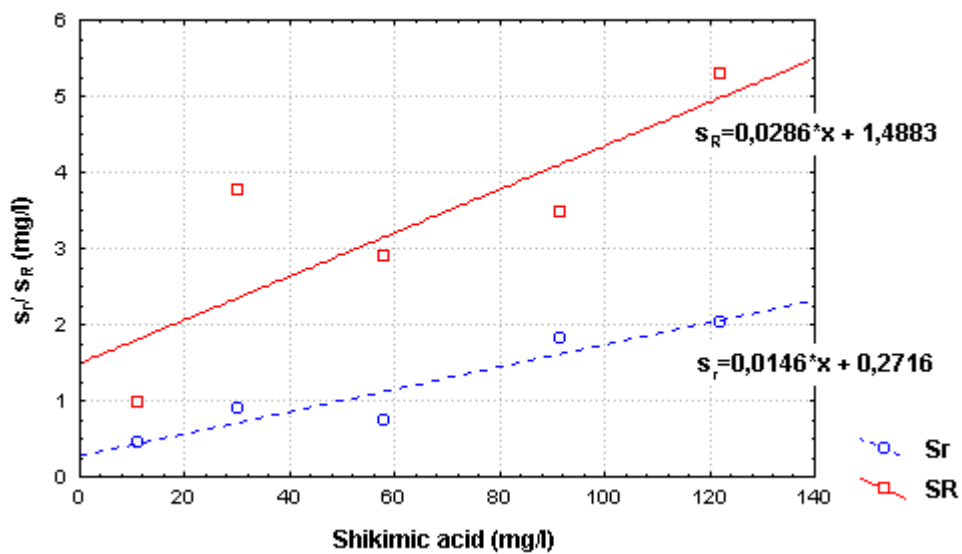

**COMPENDIUM OF INTERNATIONAL ANALYSIS OF METHODS -
OIV
Shikimic acid**

Annex 3: Table of method performance parameters

sample identification	A	B	C	D	E
Number of participating laboratories	19	19	19	19	19
Number of accepted laboratories	17	18	17	18	18
mean	58.15	30.05	11.17	122.17	91.20
s_r^2	0.54588	0.84694	0.19353	4.32417	2.67306
s_r	0.73884	0.92030	0.43992	2.07946	1.63495
RSD _r (%)	1.27	3.06	3.93	1.70	1.79
r	2.07	2.58	1.23	5.82	4.58
s_L^2	8.45221	13.27078	0.73013	24.62737	8.55508
s_R^2	8.99809	14.11773	0.92366	28.95154	11.22814
s_R	2.99968	3.75736	0.96107	5.38066	3.35084
RSD _R (%)	5.16	12.50	8.60	4.40	3.67
R	8.40	10.52	2.69	15.07	9.38

s_r^2 variance of repeatability
 s_r standard deviation of repeatability
RSD_r (%) relative standard deviation of repeatability
r repeatability
 s_L^2 variance between laboratory
 s_R^2 variance of reproducibility
 s_R variance of reproducibility
RSD_R (%) relative standard deviation of reproducibility
R reproducibility

**Determination of sorbic acid in wines
by capillary electrophoresis**

OENO 4/2006; OIV/OENO 377/2009

1 Scope

The present method is used to determine the sorbic acid in wines in a range from 0 to 300 mg/l.

2 Principle

The negatively charged sorbate ion naturally enables easy separation by capillary electrophoresis. At the capillary outlet, detection is carried out in the ultraviolet spectrum at 254 Nm.

3 Reagents and products

3.1 Reagents

- 3.1.1 Sodium dihydrogenophosphate [10049-21-5] purity > 96%
- 3.1.2 Sodium hydrogenophosphate [10028-24-7] purity > 99%
- 3.1.3 Sodium hydroxide [1310-73-2] purity > 97%
- 3.1.4 Hippuric sodium [532-94-5] purity > 99%
- 3.1.5 Demineralised water (< 15 MOHMS) or double-distilled

3.2 Migration buffer solution

The migration buffer is made up in the following way:

Sodium dihydrogenophosphate (3.1.1): 5 mM
Sodium hydrogenophosphate(3.1.2) 5 mM

3.3 Internal standard

Hippuric sodium (3.1.4) in an aqueous solution 0.5 g.L-1

3.4 Rinse solutions

- 3.4.1 Sodium hydroxide (3.1.3) N/10
- 3.4.2 Sodium hydroxide (3.1.3) N

4 Sample preparation

The wine samples are prepared as follows, which involves a 1/20 dilution:

Wine to be analyzed: 0.5 ml
Sodium hydroxide (3.1.3): 0.5 ml
Internal standard (3.1.4) with 0.5 g L⁻¹: 0.5 ml
Qsp 10 ml with demineralized water (3.1.5)

5 Operating conditions

5.1 Conditioning the capillary

Before its first use, and as soon as the migration times increase, the capillary must be conditioned according to the following process:

5.1.1 Rinse with sodium hydroxide solution 1N (3.4.2) at 20 psi (140 kPA) for 8 min.

5.1.2 Rinse with sodium hydroxide solution (3.4.1) 0.1 N at 20 psi (140 kPA) for 12 min.

5.1.3 Rinse with water (3.1.5) at 20 psi (140 kPA) for 10 min.

5.1.4 Rinse with the migration buffer (3.2) at 20 psi (140 kPA) for 30 min.

5.2 Migration conditions

These conditions may be slightly changed depending on the equipment used.

5.2.1 The molten silica capillary is 31 cm long, with a diameter of 50 microns.

5.2.2 Migration temperature: 25°C

5.2.3 Reading wavelength: 254 nm.

5.2.4 Reading of the signal in direct mode (sorbic acid absorbs in the UV spectrum).

5.2.5 First Pre-rinse under pressure 30 psi (210 kPA) with sodium hydroxide solution 0.1 N (3.4.1) for 30 seconds

5.2.6 Second Pre-rinse under pressure 30 psi (210 kPA) with the migration buffer (3.2) for 30 seconds.

5.2.7 The injection is done under a pressure of 0.3 psi (2.1 kPA) for 10 seconds.

5.2.8 The migration lasts approximately 1.5 to 2 minutes under a potential difference of + 25 kV, in normal polarity (cathod at the exit).

5.2.9 Certain capillary electrophoresis apparatus propose large-capacity vials for migration buffer solutions. This is preferable when several analyses are carried out in series, because the electrolytic properties are maintained longer.

5.3 Reading the results

The absorption peaks for the internal standard and the sorbic acid are obtained on average 1 to 1.5 minutes after the start of the migration phase live. Migration time is fairly constant, but can slightly vary according to the state of the capillary. If the migration time degrades, reconditioning of the capillary is necessary, and if the nominal conditions are not restored, the capillary must be replaced.

6 Characteristics of the method

The different validation steps described were carried out according to the OIV resolution OENO 10/2005.

6.1 Intralaboratory repeatability

Standard repeatability deviation S_r	1.6 mg/ L ⁻¹
Repeatability r	4.6 mg/ L ⁻¹

6.2 Linearity

Regression line	$Y = 0,99491 X + 2,52727$
Correlation coefficient r	0,9997
Residual standard deviation S_{xy}	1,6 mg.L ⁻¹
Standard deviation slope S_b	0,008 mg.L ⁻¹

6.3 Intralaboratory reproducibility

Standard reproductibility deviation S_r	2.1 mg/ L ⁻¹
Reproductibility R	5.8 mg/ L ⁻¹

6.4 Detection and quantification limits

Detection limit L_d	1.8 mg/ L ⁻¹
Quantification limit L_q	4.8 mg/ L ⁻¹

6.5 Robustness

6.5.1 Determination

Since the method is relative, any slight variations in the analysis conditions will have no effect on the final result, but will primarily influence the migration time.

6.6 Method specificity

Possible influence of principle oenological additives were tested. None of them modify the results obtained.

6.7 Correlating the method with the OIV reference method

The OIV reference method is determination by ultraviolet absorption spectrometry. The sorbic acid, extracted by steam distillation, is determined in the wine distillate by ultraviolet absorption spectrometry at 256 Nm.

6.7.1 Comparison of repeatabilities

	Capillary electrophoresis	OIV reference method
Standard deviation of repeatability S_r	1.6 mg/l	2.5 mg/ L⁻¹
Repeatability r	4.6 mg/l	7.0 mg/ L⁻¹

6.7.2 Accuracy of the usual method in relation to the reference method

Coefficient of correlation r	0.999
Average bias M_d	0.03 mg L⁻¹
Average bias standard deviation S_d	3.1 mg L⁻¹
Z-score (M_d/S_d)	0.01

Method OIV-MA-AS313-19

Method Type: II for organic acids
III for sulphate

**Determination of the principal organic acids of wines and
sulphates by capillary electrophoresis**

OENO 5/2006
OIV-OENO 407-2011

1. Introduction

Tartaric, malic and lactic acids and sulphates are separated and assayed by capillary electrophoresis after simple dilution and addition of an internal standard.

2. Title

**Determination of the principal organic acids of wines and sulphates by
capillary electrophoresis**

3. Scope

Capillary electrophoresis can be used to assay the tartaric and malic acid in musts, as well as the tartaric, malic and lactic acids and sulphates in wines that have been diluted, degassed and filtered beforehand if need be.

4. Définitions

4.1 Capillary electrophoresis

Capillary electrophoresis: all the techniques that use a capillary tube of very small diameter with an appropriate buffer solution to effectively separate small and large electrically charged molecules in the presence a high-voltage electric current.

4.2 Buffer for electrophoresis

Solution containing one or more solvents and aqueous solutions with suitable electrophoretic mobilities to buffer the pH of the solution.

4.3 Electrophoretic mobility

Aptitude of an ion to move quickly under the effect of an electric field.

4.4 Electroosmotic flow

Flow of solvent in the buffer solution along the internal wall of the capillary tube due to displacement of the solvated ions under the effects of the field and the electric charges of the silica.

5. Principle

Separations of the aqueous solutions of a mixture by capillary electrophoresis are obtained by differential migrations in a buffered electrolyte referred to as a buffer. The electrophoresis takes place in a silica tube with an inside diameter ranging between 25 and 75 μm . The aqueous solutions to be separated are simultaneously driven by 2 forces that can act in the same direction or in the opposite direction. These two forces are caused by the **electric field** and the **electroosmotic flow**.

The electric field is represented by the voltage in volts applied between the electrodes brought to within one centimetre of the capillary tube, and is expressed in $\text{V}\cdot\text{cm}^{-1}$. Mobility is a characteristic of ions. The smaller the molecules, the greater their electrophoretic mobility.

If the internal wall of the capillary tube is not coated, the negative electric charges of the silica fix part of the cations of the buffer. The solvation and displacement towards the cathode of part of the cations of the buffer create the electroosmotic flow. The pH of the buffer and additives can be chosen in order to control the direction and the intensity of the electroosmotic flow.

The addition of a chromophoric ion in the buffer can be used to obtain negative peaks that quantitatively represent the solutions to be separated which do not absorb at the used wavelength.

6. Reagents and products

6.1 Chemically pure grade products for analysis at least at 99%

6.1.1 Sodium sulphate or Potassium sulphate

6.1.2 L-tartaric acid

6.1.3 D,L- malic acid

6.1.4 Monohydrated citric acid

6.1.5 Succinic acid

6.1.6 D,L Lactic acid

6.1.7 Sodium dihydrogenophosphate

6.1.8 Sodium gluconate

6.1.9 Sodium chlorate

6.1.10 Dipicolinic acid

6.1.11 Cethyltrimethyl ammonium bromure

6.1.12 Acetonitrile for HPLC

6.1.13 Deionized ultra filtered pure water

6.1.14 Sodium hydroxide

6.2 Solutions

6.2.1 Calibration stock solution

- Solution in pure water (6.1.13) of different acids and sulphates to be measured (6.1.1 to 6.1.6) at exact known concentrations ranging between 800 and 1200 mg l⁻¹
- Solution to be kept at +5° C for a maximum of 1 month

6.2.2 Internal standard solution

- Solution of sodium chlorate (6.1.9) at approximately 2 g l⁻¹ in pure water (6.1.13)
- Solution to be kept at +5° C for a maximum of 1 month

6.2.3 Calibration solution to be injected

In a graduated 50-ml class "A" flask using class "A" pipettes, deposit:

- 2 ml of calibration solution (6.2.1)
- 1 ml of internal standard solution (6.2.2)
- Adjust solution to 50 ml with pure water (6.1.13)

Homogenize by agitation

Solution to be prepared each day

6.2.4 Sodium hydroxide solutions

6.2.4.1 Sodium hydroxide solution M

In a 100-ml flask place 4g of sodium hydroxide (6.1.14)

Adjust with pure water (6.1.13)

Shake until completely dissolved.

6.2.4.2 sodium hydroxide solution 0.1M

In a 100 ml flask place 10 ml of sodium hydroxide M (6.2.4.1)

Adjust with pure water (6.1.13)

Homogenise.

6.2.5 Electrophoretic buffer solution

In a graduated 200-ml class "A" flask, place:

- 0.668 g of dipicolinic acid (6.1.10)
- 0.364 g of cethyltrimethyl-ammonium bromide. (6.1.11)
- 20 ml of acetonitrile (6.1.12)
- Approximately 160 ml of pure water (6.1.13)
- Shake until complete dissolution (if need be, place in ultrasound bath to eliminate any aggregated material)

- Bring M sodium hydroxide solution M (6.2.4.1) to pH 5.64 and then 0.1M sodium hydroxide (6.2.4.2)
- Make up to 200 ml with pure water (6.1.13)
- Homogenize by agitation
- Solution to be prepared each month.
- Store at laboratory temperature.

This buffer can be replaced by equivalent commercial product.

7. Apparatus

The capillary electrophoresis apparatus required for these determinations basically comprises:

- A sample changer
- Two bottles (phials) containing the buffer
- A non-coated silica capillary tube, internal diameter 50 μm , length 60 cm, between the inlet of the capillary tube and the detection cell. Depending on the apparatus, an additional 7 to 15 cm are required so that the outlet of the capillary tube is immersed in the centre of another bottle
- A high voltage DC power supply capable of outputting voltages of -30 to + 30 kV. The electrodes immersed in the two bottles where the outlets of the capillary tube emerge are connected to the terminals of the generator
- A pressurization system capable of circulating the buffer in the capillary tube and enabling the injection of the test specimen
- A UV detector
- A data acquisition system

8. Preparation of samples for tests

8.1 Degassing and filtration

The samples rich in carbon dioxide are degassed for 2 min with ultra-sound. Turbid samples are filtered on a membrane with an average pore diameter of 0.45 μm .

8.2 Dilution and addition of internal standard

Place 2 ml of sample in a graduated flask of 50 ml. Add 1 ml of internal standard solution (6.2.2). Adjust to 50 ml with pure water (6.1.13)

Homogenize.

9. Procedure

9.1 Conditioning of a new capillary tube (for example)

- Circulate pure water (6.1.13) in the opposite direction (from the outlet of the capillary tube towards the inlet flask) for 5 min at a pressure of approximately 40 psi (2.76 bar or 276 kPa)
- Circulate 0.1M sodium hydroxide (6.2.4.2) in the opposite direction for 5 min at the same pressure
- Circulate pure water (6.1.13) in the opposite direction (from the outlet of the capillary tube towards the inlet flask) for 5 min at the same pressure
- Repeat the cycle of circulating pure water, 0.1M sodium hydroxide, pure water
- Circulate electrophoretic buffer (6.2.5) in the opposite direction for 10 min

9.2. Reconditioning a capillary tube in the course of use (optional)

When the quality of the separations becomes insufficient, new conditioning of the capillary tube is essential. If the results obtained are still not satisfactory, change capillary tube and condition it.

9.3. Checking the quality of the capillary tube (optional)

Analyse 5 times the calibration solution under the recommended analysis conditions.

9.4. Separation and detection conditions (for example)

- Light the detector lamp 1 hour before the start of the analyses
- Rinse the capillary tube by circulating the buffer for 3 min in the opposite direction at a pressure of 40 psi
- Pressure inject the samples (prepared at 8.1) at 0.5 psi for 6 to 15 seconds
- The polarity is regulated such that the anode is on the detector side

- Apply a voltage from 0 to 16 kV in 1 min then 16 kV for approximately 18 min (the duration of separation can slightly vary depending on the quality of the capillary tube)
- Maintain the temperature at + 25 C°
- Detection in the ultraviolet is at 254 Nm
- Rinse the capillary tube by circulating the electrophoretic buffer (6.2.5) for 2 min in the opposite direction at a pressure of 40 psi
- Change the electrophoretic buffer (6.2.5) contained in the inlet and outlet flasks at least every 6 injections

9.5 Order that the analyses are to be carried out (for example)

Change the electrophoretic buffer (6.2.5) for every new series of analyses

- The sequence of analysis in order contains: Analysis of reference material (external concentration sample known for different acids to be measured)
- Analysis of samples prepared in 8.2, chromatograms should look like those presented in appendix A
- At the end of analysis, rinse with pure water (6.1.13) 10 mm in opposite direction (outlet of capillary tube toward the inlet)
- Switch off detector lamp

10. Calculation of results

The calculations are based on the surface areas of the peaks obtained after integration.

The surface areas of the peaks of the aqueous solutions of the calibration solution (6.2.3) are corrected by taking into account the variations in the surface areas of the peaks of the internal standard. The response factor for each acid is calculated.

The surface areas of the peaks of the internal standard and the peaks of the aqueous solutions are read off for each sample. The surface areas of the aqueous solutions to be assayed are recalculated by taking into account variations in the surface areas of the peaks of the internal standard a second time in order to obtain "corrected" surface areas.

The corrected surface areas are then multiplied by the value of the corresponding response factor.

COMPENDIUM OF INTERNATIONAL ANALYSIS OF METHODS - OIV ORGANIC ACIDS AND SULPHATES BY CAPILLARY ELECTROPHORESIS

It is possible to use an automatic data management system, so that they can be controlled in accordance with the principles described above as well as with the best practices (calculation of response factor and / or establishment of a calibration curve).

CALCULATION FORMULA

The abbreviations used to calculate the concentration in an acid are given in the following table:

Surfaces are expressed by the whole numbers of integration units.

The concentrations are given in g/L (only indicate to two decimal places).

ABBREVIATIONS		
	REFERENCE SOLUTION	SAMPLE
SURFACE AREAS OF TITRATED PEAKS	S_{AR}	S_{AE}
INTERNAL STANDARD PEAKS	S_{EIR}	S_{EIE}
CONCENTRATION	C_{AR}	C_E

The calculation formula is:

$$C_E = \frac{C_{AR} \times S_{AE} \times S_{EIR}}{S_{AR} \times S_{EIE}}$$

Whenever possible, a duplicate analysis is used to highlight a possible error in the recognition of the peaks or inaccuracy of integration. The sample changer makes it possible to carry out the analyses in automatic mode day and night.

11. Precision

11.1 Organization of the tests

Interlaboratory trials and correspondent results are described in appendix B1 and B2

**COMPENDIUM OF INTERNATIONAL ANALYSIS OF METHODS - OIV
ORGANIC ACIDS AND SULPHATES BY CAPILLARY ELECTROPHORESIS**

11.2 Measurement of precision

ASSESSMENT OF PRECISION BY INTERLABORATORY TRIALS

Number of laboratories involved: 5

Results expressed in mg / L			
	TARTRIC ACID	MALIC ACID	LACTIC ACID
Average values of concentrations	1395	1884	1013
Average values of standard deviations in repeatability	38	54	42
Average values of standard deviations in reproducibility	87	113	42

12. APPENDICES

**APPENDIX A
ELECTROPHOREGRAM OF A STANDARD SOLUTION OF ACI**

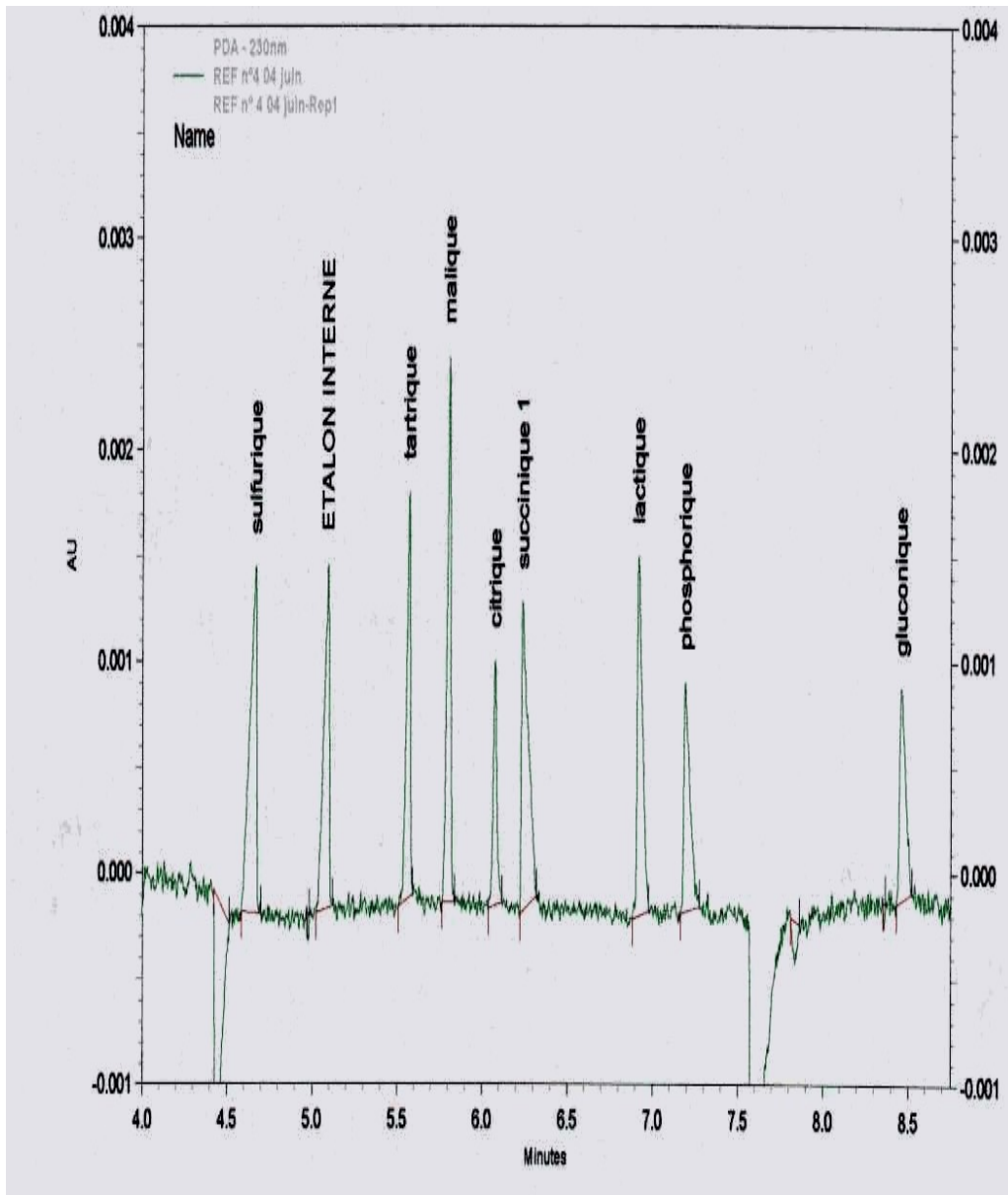

ELECTROPHEROGRAM OF A WINE

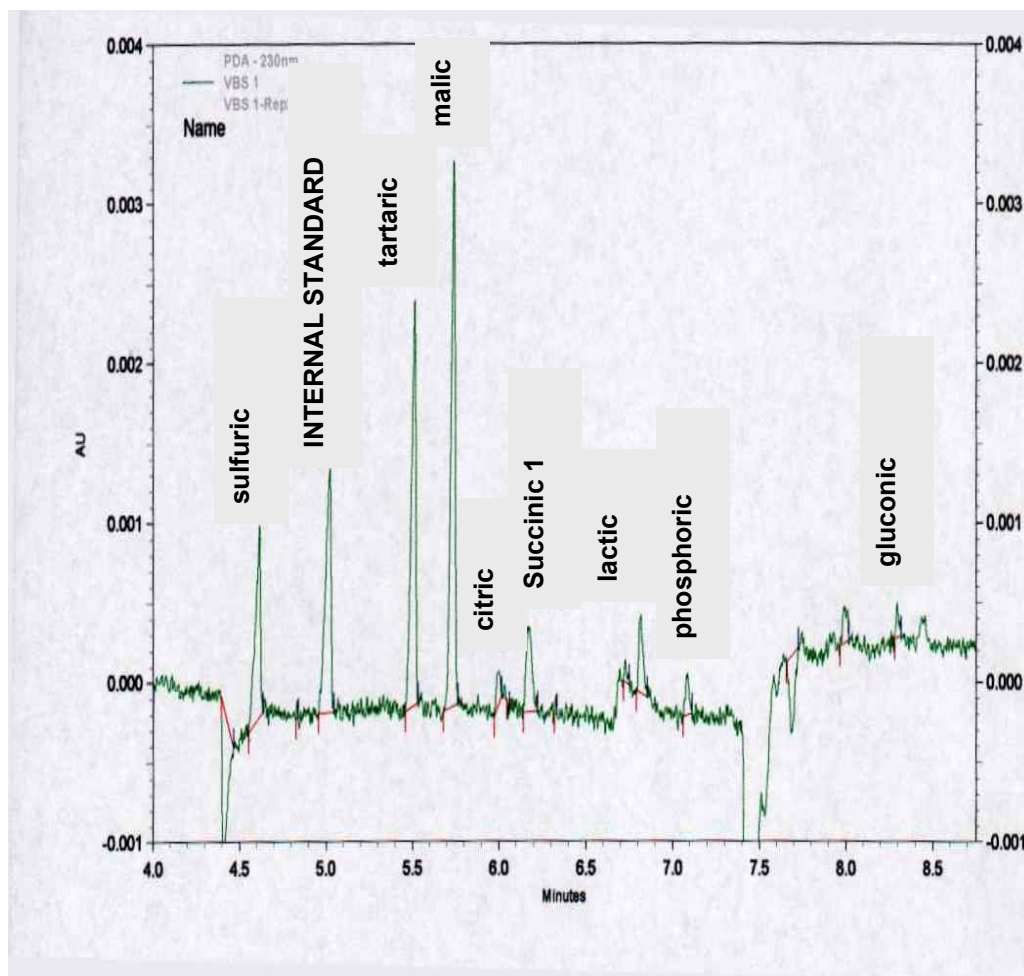

APPENDIX B1

Statistic data obtained from the results of the interlaboratory trials
(2006)

**COMPENDIUM OF INTERNATIONAL ANALYSIS OF METHODS - OIV
ORGANIC ACIDS AND SULPHATES BY CAPILLARY ELECTROPHORESIS**

According to ISO 5725-2:1994, the following parameters have been defined during an interlaboratory trial. This trial has been conducted by the laboratory « Direction Générale de la Consommation et de la Répression des Fraudes de Bordeaux (France). »

Year of interlaboratory trial: 2006

Number of laboratories: 5

Number of samples: 8 double-blind (2 dry white wines, 2 sweet white wines, 2 rosé wines and 2 red wines)

INTERLABORATORY TESTS

Determination of TARTRIC ACID by capillary electrophoresis

Identification of the sample	dry white wines		liquorous white wines		rosé wines		red wines	
	A + D	B + C	E + F	G + H	I + J	K + L	M + N	O + P
Number of laboratories taking part	5	5	5	5	5	5	5	5
Number of results accepted	5	5	4	5	5	5	4	5
Average value in mg/l	1943	2563	1440	255	553	1885	1373	1148
Accepted value in mg/l	1943	2563	1387	2217	1877	1593	1370	1830
Standard deviation of repeatability (Sr)	27	25	106	23	40	31	25	24
Repeatability coefficient of variation	1.4	1.0	7.7	1.0	2.2	1.9	1.8	1.3
Limit of repeatability (r)	77	70	298	65	113	86	70	66

INTERLABORATORY TESTS								
Identification of the sample	dry white wines		liquorous white wines		rosé wines		red wines	
	A + D	B + C	E + F	G + H	I + J	K + L	M + N	O + P
Standard deviation of reproducibility (SR)	96	128	174	80	57	55	52	53
Reproducibility coefficient of variation in %	4.9	5	12.6	3.6	3	3.5	3.8	2.9
Reproducibility limit (R)	268	359	488	223	160	154	145	148
Number of laboratories taking part	5	5	5	5	5	5	5	5
Number of results accepted	5	5	5	5	5	5	4	5
Average value in mg/l	2571	1602	1680	2539	3524	2109	173	869
Accepted value in mg/l	2571	1602	1680	2539	3524	2109	177	869
Standard deviation of repeatability (Sr)	54	19	113	35	61	109	7	32
Repeatability coefficient of variation	2.1	1.2	6.7	1.4	1.7	5.2	4.1	3.7
Repeatability limit (r)	151	54	315	99	170	305	20	89
Standard deviation of reproducibility (SR)	90	51	171	97	279	142	21	53
Reproducibility coefficient of variation in %	13.6	9.8	41	39.6	14.7	9	14.1	7.6
Limit of reproducibility (R)	252	142	479	273	782	397	59	148

up

**COMPENDIUM OF INTERNATIONAL ANALYSIS OF METHODS - OIV
ORGANIC ACIDS AND SULPHATES BY CAPILLARY ELECTROPHORESIS**

INTERLABORATORY TESTS								
Determination of LACTIC ACID by capillary electrophoresis results in mg/l								
Sample identification	dry white wines		liquorous white wines		rosé wines		red wines	
	A + D	B + C	E + F	G + H	I + J	K + L	M + N	O + P
Number of laboratories taking part	5	5	5	5	5	5	5	5
Number of results accepted	4	5	5	5	5	5	4	5 ⁴
Average value in mg/l	659	1324	258	255	553	1885	2066	1148
Accepted value in mg/l	650	1324	258	255	553	1885	2036	1148
Standard deviation of repeatability (Sr)	20	42	20	39	27	99	75	16
Repeatability coefficient of variation	3,1	3,2	7,8	15,1	4,8	5,3	3,7	16,0
Repeatability limit (r)	57	117	56	108	75	278	211	46
Standard deviation of reproducibility (SR)	20	42	20	39	27	99	75	16
Reproducibility coefficient of variation in %	13,6	9,8	41	39,6	14,7	9	14,1	7,6
Reproducibility limit (R)	247	363	296	283	227	475	802	243

APPENDIX B2

**Statistic data obtained from the results of the interlaboratory trials
(sulphates 2010)**

According to ISO 5725-2:1994, the following parameters have been defined during an interlaboratory trial. This trial has been conducted by the laboratory “Instituto dos Vinhos do Douro e do Porto (Portugal)”

Year of interlaboratory trial: 2010-2011

Number of laboratories: 7 (one laboratory sent two sets of results obtained by means of two different instruments)

Number of samples: 6 double-blind

**COMPENDIUM OF INTERNATIONAL ANALYSIS OF METHODS - OIV
ORGANIC ACIDS AND SULPHATES BY CAPILLARY ELECTROPHORESIS**

Indicators	White wine (A/G)	Rosé (B/F)	Rosé (C/O)	Red wine (D/M)	Liquor wine (E/N)	Liquor wine (I/K)	White wine (H/Q)	Red wine (J/P)	Liquor wine (L)
Number of groups	7	7	6	7	8	7	7	7	8
Number of repetitions	2	2	2	2	2	2	2	2	2
Minimum (g/L K ₂ SO ₄)	0,71	0,34	0,40	0,62	1,79	1,06	1,38	1,96	2,17
Maximum (g/L K ₂ SO ₄)	0,88	0,54	0,52	0,75	2,40	1,35	1,70	2,30	2,85
Repeatability variation s_r^2	0,0012	0,0011	0,0001	0,0016	0,0063	0,0013	0,0036	0,0015	0,0053
Intergroup variation s_L^2	0,00148	0,00230	0,00163	0,00055	0,01952	0,01082	0,00668	0,01744	0,03552
Reproducibility variation s_R^2	0,0027	0,0034	0,0018	0,0022	0,0258	0,0122	0,0103	0,0189	0,0408
Mean (g/L K ₂ SO ₄)	0,78	0,43	0,44	0,69	2,01	1,19	1,49	2,15	2,41
Standard deviation of Repeatability (g/LK ₂ SO ₄)	0,04	0,03	0,01	0,04	0,08	0,04	0,06	0,04	0,07
Limit r (g/L K ₂ SO ₄)	0,100	0,093	0,031	0,115	0,224	0,103	0,170	0,109	0,206
Repeatability CV	5%	8%	3%	6%	4%	3%	4%	2%	3%
Standard deviation of Reproducibility (g/L K ₂ SO ₄)	0,05	0,06	0,04	0,05	0,16	0,11	0,10	0,14	0,20
Limit R (g/L K ₂ SO ₄)	0,148	0,165	0,118	0,132	0,454	0,312	0,287	0,389	0,572
Reproducibility CV	7%	14%	10%	7%	8%	9%	7%	6%	8%
HORRAT	1,1	2,1	1,5	1,1	1,6	1,7	1,3	1,3	1,7

13. Bibliography

- ARELLANO M., COUDERC F. and PUIG .L (1997): Simultaneous separation of organic and inorganic acids by capillary zone electrophoresis. Application to wines and fruit juices. *Am. J. Enol. Vitic.*, 48, 408-412.
- KANDL T. and KUPINA S. (1999): An improved capillary electrophoresis procedure for the determination of organics acids in grape juices and wine. *Am. J. Enol. Vitic.*, 50, 155-161.
- KLAMPF C.F. (1999): Analysis of organic acids and inorganic anions in different types of beer using capillary zone electrophoresis. *J. Agric. Food Chem.*, 47, 987-990.

Method OIV-MA-AS313-20

Type IV method

Determination of sorbic, benzoic and salicylic acid content in wine by the use of high-performance liquid chromatography
(Resolution OENO 6/2006; OIV/OENO 377/2009; OIV-OENO 687-2023)

1. Introduction

Sorbic acid and its potassium salt constitute an antiseptic that can be used in wine-making, although some countries will not tolerate even traces of it, the main reason being the smell of geraniums that develops when sorbic acid is broken down by lactic acid bacteria. Benzoic acid and salicylic acid are still prohibited in wine, but are used in other beverages.

2. Scope

All wines and grape musts, especially those likely to contain only traces of sorbic, benzoic or salicylic acid.

3. Principle

The antiseptics are determined using HPLC by direct injection of the sample into a column functioning by isocratic reversed-phase partition chromatography with ultraviolet detection.

4. Products

- 4.1 Micro-filtered fresh water (e.g. resistivity greater than 18.2 MΩ)
 - 4.2 Pure tetrahydrofuran
 - 4.3 Pure methanol
 - 4.4 0.1 M hydrochloric acid (prepared by means of dilution funnels)
 - 4.5 Water with a pH of 2: adjust the pH of 650 ml of water (4.1) to pH2 using a pH meter (5.5) and by adding 0.1 M hydrochloric acid drop by drop without stirring (4.4)
 - 4.6 Elution solution: mix 650 ml of water at pH2 (4.5) with 280 ml of methanol (4.3) and 7 ml of tetrahydrofuran (4.2)
- Note: it is likewise possible to use other elution solvents, for example: 80% ammonium acetate 0.005M (0.38 g/l) adjusted to pH 4 with pure acetic acid + 20% acetonitrile.

- 4.7 Pure sorbic acid
 - 4.8 Pure benzoic acid
 - 4.9 Pure salicylic acid
 - 4.10 Absolute alcohol
 - 4.11 50% vol. hydro-alcohol solution or other suitable concentration: put 500 ml of absolute alcohol (4.10) into a 1-litre flask and dilute to volume with distilled water (4.1)
 - 4.12 Stock solution of sorbic acids at 500 mg/l: dissolve 50 mg of sorbic acids (4.7), benzoic (4.8) and salicylic (4.9) acids in 100 ml of the 50% vol. hydro-alcohol solution (4.11)
 - 4.13 Sorbic, benzoic and salicylic acid surrogate solutions: dilute the stock solution (4.12) in the hydro-alcohol solution (4.11) in such a way as to obtain the final concentrations required. For example, for a solution of
 - 200 mg/l: put 20 ml of stock solution (4.12) into a 50-ml flask and top up to the filling mark with 4.11.
 - 1 mg/l: put 2 ml of stock solution (4.12) into a 50-ml flask and top up to the filling mark with 4.11.
- Intermediate solutions may be produced in the same way to satisfy calibration requirements.

5. Apparatus

- 5.1 Laboratory glassware, especially pipette and volumetric flasks
- 5.2 Ultrasonic bath
- 5.3 Vacuum filtration device for large volumes (1 litre) using membrane filters with a pore diameter of under 1 μm (generally 0.45 μm)
- 5.4 Mini-filter for samples (1 to 2 ml) using membrane filters with a pore diameter of under 1 μm (generally 0.45 μm)
- 5.5 pH meter
- 5.6 Isocratic-mode liquid phase chromatograph equipped with an injection system for small volumes (for example), 10 or 20- μl loop valve.
- 5.7 Detector capable of functioning at an ultraviolet rating of 235 nm (1) and fitted with a circulating tank for HPLC (for example, 8 μl for 1 cm of optical thickness)

- 5.8 A 5- μm stationary phase HPLC column of the silica-type with immobilisation by octadecyl groups (C18), length 20 cm, inside diameter 4 mm (1)
- 5.9 Data acquisition system

6. Preparation of samples and the elution solvent

- 6.1 Filter the samples to be analysed using the mini-filter (5.4)

COMPENDIUM OF INTERNATIONAL ANALYSIS OF METHODS - OIV Sorbic, Benzoic and Salicylic acids - HPLC

6.2 Degas the elution solvent (4.6) for 5 minutes using the ultrasonic bath (5.2) or any other suitable way

6.3 Filter the solvent using the device in (5.43)

7. Procedure

7.1 Column conditioning. Prior to injection, start the pump and rinse the column with the solvent for at least 30 minutes.

7.2 Inject one of the surrogate solutions (4.13) to check system sensitivity and ensure the resolution of the peaks of the substances to be analysed is satisfactory.

7.3 Inject the sample to be analysed. It is possible to analyse an identical sample, to which the acids sought have been added (adapt the amount added to the quantity observed during the previous analysis - for 1 mg present, add 1 mg, and so on).

Check the resolution of the peaks of the acids sought with the peaks of the wines (normally, there are none in this zone)

8. Calculation

Having located the peaks of the acids to be determined in the sample, compare the peak area with those of the acids of a surrogate solution (4.13) with a known concentration C.

For example, let s be the peak area of the acid to be determined, and S is the peak area of the solution (4.13) with concentration C

$$X_{\text{in the sample}} = C \times \frac{s}{S} \quad \text{in mg/l}$$

It is also possible to use a calibration curve and determine the concentration by interpolation.

9. Characteristics of the method

9.1. For Sorbic acid

Interlaboratory trial and correspondent results are described in Annex A

- $r=0.0148 x + 0.5498$
- $R=0.0936 x + 1.5542$
- x : sorbic acid and concentration (mg/l)

9.2. For Benzoic and Salicylic acids

	Benzoic acid	Salicylic acid
Linearity range	0 to 200 mg/l	0 to 200 mg/l
Accuracy (rate of recuperation)	> 90 %	> 90 %
Répétabilité : r*	3%	8%
Reproducibility: R*	9%	12%
Detection limit	3 mg/l	3 mg/l
Quantification limit	6 mg/l	7 mg/l
Uncertainty	12%	13%

Annex A – Statistic data obtained from the results of the interlaboratory trials

The following parameters have been defined during an interlaboratory trial. This trial has been conducted by the laboratory “Instituto dos Vinhos do Douro e do Porto (Portugal”.

Year of interlaboratory trial: 2020

1. Laboratories: 23 laboratories from 14 different countries

HBLA und Bundesamt für Wein- und Obstbau Klosterneuburg	Austria
Department of Agriculture	Cyprus
Czech Agriculture and Food Inspection Authority	Czech Republic
Comité Interprofessionnel du Vin de Champagne	France

COMPENDIUM OF INTERNATIONAL ANALYSIS OF METHODS - OIV
Sorbic, Benzoic and Salicylic acids - HPLC

Laboratoires Dubernet	France
Service Commun des Laboratoires- Laboratoire de Montpellier	France
Service Commun des Laboratoires- Laboratoire de Bordeaux	France
Landesuntersuchungsamt, Institut für Lebensmittelchemie	Germany
Lebensmittel- u. Veterinärinstitut Braunschweig/Hannover	Germany
National Food Chain Safety Office	Hungary
Unione Italiana Vini Servizi	Italy
Vassanelli Lab s.r.l.	Italy
AsureQuality Ltd Laboratory Services	New Zealand
Arcus Norway AS	Norway
ASAE-Autoridade de Segurança Alimentar e Económica	Portugal
Instituto dos Vinhos do Douro e do Porto	Portugal
RUDN University	Russian Federation
National Laboratory of Health, Environment and Food (Novo Gorica)	Slovenia
National Institute of Chemistry	Slovenia
National Laboratory of Health, Environment and Food (Novo Mesto)	Slovenia
Laboratorio Arbitral Agroalimentario.	Spain
Estación Enológica de Haro- La Rioja	Spain
Cukurova University Food Engineering Dept.	Turkey

2. Number of samples: 6 samples in duplicate

- 2 white wines: A/G, C/K
- 1 white wine – late harvest: I/O
- 1 red wine: D/M
- 1 rosé wine: B/F
- 1 red fortified wine (alcoholic strength – 19% vol.) : E/N

3. Analytical conditions

The analytical conditions are summarized in Table 1.

4. Individual results

The individual results for Sorbic Acid (mg/L) are summarized in Table 2.

5. Data analysis

- Statistical analysis was performed according to the recommendations of the OIV obtain precision data.
- The values below the quantification limit were treated as normal values.
- Determination of outliers was assessed by Cochran and Grubbs test.
- The results are summarized in tables 3 and 4.
- Repetibility and reproducibility limit according to sorbic acid concentration are represented in figure 1.
- The Z-score for each laboratory was evaluated against the global values for the different samples. The results are in figure 2.

TABLE 1 – ANALYTICAL CONDITIONS

Lab. Code	Calibration Curve	Column	Detection	Mobile phase	Flow rate (mL/min)	Column temperature (°C)	Injection volume (µL)
1	yes	Altima C18LL 5 µm 250 x 4.6 mm	$\lambda = 235$ nm	Water pH=2.0 / MeOH/ THF (650/280/70)	1	ambient	20
2	yes	C18 250 x 4.6 Luna Phenomene x	$\lambda = 235$ nm	0.389 Ammonium acetate in 1L water + 250 mL ACN (pH=4 adjusted w/ CH ₃ COOH)	1.25	35	20

**COMPENDIUM OF INTERNATIONAL ANALYSIS OF METHODS - OIV
Sorbic, Benzoic and Salicylic acids - HPLC**

3	yes	Poreshell 120 EC-C18 .150 x 4.4 mm; 2.7 µm	λ = 235 nm	A: H2O 0.7 % THF (pH=2) /B: MeOH (80 % A e 20 % B)	1.5	40	5
4	yes	RP-18 (250-4)	λ = 254 nm	Ammonium acetate buffer (pH 4.4): MeOH = 70:30	1	40	20
6	yes	PerfectSil Target ODS-3 HD. 5 µm. 250 x 4.6 mm	λ = 235 nm	ACN:Buffer solution (35 :65); Buffer solution = Ammonium acetate (1.8 g/l) + Acetic acid.	1	40	2
7	yes	PoroShell C18 4.6 x 75 mm; 2.7 µm	λ = 235 nm	Isocratic: 80 % H2O acid. with sulfuric	1.5	25	20
8	yes	Rezex-ROA-Organic acid H+ (8 %) -300 x	λ = 254 nm	Elution solvent Sulfuric acid = 0.025M	1	90	50
9	yes	HICROM Ultrasphere 5 µm ODS column. 250 x 4.6 mm	λ = 235 nm	650 mL H2O pH 2 with 280 mL MeOH + 7 mL THF	0.6	25	20
10	yes	Teknokroma Trace Excel 120 ODSB 5 µm. 20 x 0.4 cm	λ = 235 nm	650 mL H2O pH 2 (HCl 0.1M) + 280 mL MeOH + 7 mL THF	1	24	20

**COMPENDIUM OF INTERNATIONAL ANALYSIS OF METHODS - OIV
Sorbic, Benzoic and Salicylic acids - HPLC**

11	yes	C18 5 µm. 200x4 mm	λ = 235 nm				
12	yes	RP18 Chromolith 100 x 4.6 mm; 5 µm	λ = 235 nm	770 Water pH=2.3 (0.8 mL H ₃ PO ₄): isopropanol 200 mL. ACN 30 mL	1	25	10
13	yes	Phenomene x Gemini 5 µm. C18; 150 x 2 mm	λ = 240 nm	0.925 g ammonium acetate + 1.2 L H ₂ O +	0.4	40	10
15	yes	C18 5 µm. 200 x4 mm	λ = 235 nm	90 % v/v Water 15mL Acetic acid+ 15 g ammonium acetate 10 % v/v	1	40	10
16	yes	Prodigy 5 µm ODS-3 100. 150 x 4.6 mm w/ C18 guard	λ = 261 nm	80 % v/v H ₂ O pH=4 (pure acetic acid) + 0.005M	1.2	40	50
17		Kinetex; RP-C18 150x4.6 mm; 5 µm	λ = 230 nm	11/89. MeOH: Buffer (Buffer = 3.0 g KH ₂ PO ₄ +3.0 g K ₂ HPO ₄ + 100 mL	0.6	40	6
18	yes	C18 Luna. Phenomene x	λ = 224 nm	95 % phosphate buffer: 5 % ACN	1.2	ambient	20

**COMPENDIUM OF INTERNATIONAL ANALYSIS OF METHODS - OIV
Sorbic, Benzoic and Salicylic acids - HPLC**

19	yes	Phenomene x Aqua C18 125A 250 x 4.6 mm; 5 µm	λ = 235 nm	0.005M ammonium acetate (pH 4): ACN = 8:2	1	25	2
20	yes	Zorbax Eclipse XDB-C18 4.6 x 150 mm. 5 µm	λ = 235 nm	650 mL H ₂ O pH 2 (HCl 0.1M) + 280 mL MeOH + 7 mL THF	1	ambient	5
21	yes	RP-18 Nuclodur 100-C18. 3 µm. 50 mm	λ = 262 nm	A:B = 80:20; A: ammonium acetate. 0.002 mol/l. pH= 4.1 (adjusted by conc. Acetic acid); B: MeOH/AC N 2:1	1	60	6
22	yes	HYPERSIL ODS 250X4.6 mm. 5 µm	λ = 235 nm		1.8	40	20
23	yes	RP-C18 . 150 x 4.6 mm; 5 µm	λ = 235 nm		1	25	20
24	yes	RP-C18 Purospher .125 x 4 mm; 5 µm	λ = 235 nm	MeOH / 0.02M sodium acetate buffer pH 4.4 = (30/70 v/v)	0.8	40	5

COMPENDIUM OF INTERNATIONAL ANALYSIS OF METHODS - OIV
Sorbic, Benzoic and Salicylic acids - HPLC

26	yes	Kinetex XB-C18 100 x 4.6 mm; 2.6 μ m	$\lambda = 254$ nm	Water 0.1 % TFA. ACN 0.1 % TFA	1.5	30	10
----	-----	---	-----------------------	---	-----	----	----

**COMPENDIUM OF INTERNATIONAL ANALYSIS OF METHODS - OIV
Sorbic, Benzoic and Salicylic acids - HPLC**

TABLE 2 - INDIVIDUAL RESULTS FOR SORBIC ACID (mg/L)

Lab oratory code	White wine (A)		Rosé (B)		White Wine (C)		Red wine (D)		Fortified wine (E)		Rosé (F)		White wine (G)		White wine (I)		White wine (K)		Red wine (M)		Fortified wine (N)		White wine(O)	
	1	2	1	2	1	2	1	2	1	2	1	2	1	2	1	2	1	2	1	2	1	2	1	2
1	36.3	35.5	226.0	221.0	86.0	81.0	5.2	5.3	1.7	1.8	226.0	224.0	35.9	35.0	125.0	124.0	87.0	87.0	4.7	4.6	1.8	2.0	126.0	126.0
2	33.1	33.2	210.7	208.3	80.9	84.4	4.4	4.4	1.7	1.7	210.4	209.5	33.0	33.0	116.0	114.9	80.6	80.6	4.3	5.7	2.0	2.4	116.3	116.1
3	34.1	34.5	216.8	215.5	84.7	88.5	5.2	5.2	2.5	2.5	216.3	217.2	34.5	34.8	119.8	120.1	84.3	84.3	5.7	5.7	2.4	2.4	120.5	120.2
4	34.7	35.0	223.1	224.7	88.3	84.6	5.1	5.1	2.1	2.1	220.0	221.6	34.5	34.8	123.1	123.2	86.4	86.4	5.2	5.2	2.1	2.1	123.1	123.5
6	34.3	34.6	214.2	215.2	83.9	85.0	5.6	5.6	1.9	1.9	215.0	215.6	34.6	34.7	120.6	120.7	83.9	83.9	6.2	6.5	2.0	2.1	120.1	120.1
7	34.0	35.0	217.0	218.0	84.0	85.0	6.0	6.0	3.0	3.0	218.0	218.0	35.0	35.0	122.0	123.0	84.0	84.0	5.0	5.0	2.0	2.0	122.0	122.0
8	33.9	33.4	216.0	218.0	86.2	83.0	4.5	4.5	2.0	2.0	218.0	215.0	35.2	33.0	122.0	118.0	84.2	84.0	4.3	4.1	2.0	2.0	124.0	124.0

OIV-MA-AS313-20 : R2023

COMPENDIUM OF INTERNATIONAL ANALYSIS OF METHODS - OIV
Sorbic, Benzoic and Salicylic acids - HPLC

			8	.5		8	5		0	8	5		9	.0	.9		3				5	3.3
9	32.5	32.5	197.	198	80.	3.			1.	197.	195.		32.	112	112		79.				113.	11
			4	.2	81.0	7	4	3.4	1.4	4	0	8	32.1	2	.5	.2	79.3	4	3.3	3.3	1.3	1.2
			216.	217	83.	5.			2.	216.	216.		34.	118	119		83.				120.	11
10	34.1	34.1	0	.0	83.7	6	7	5.6	2.2	1	0	0	34.2	0	.0	.0	83.4	4	5.6	5.8	2.1	2.1
			227.	229	90.	4.			1.	224.	225.		36.	127	127		89.				128.	12
11	36.8	37.0	2	.9	90.2	4	6	4.8	2.1	9	2	6	37.1	8	.4	.0	88.4	0	4.0	4.3	2.1	1.9
			207.	202	78.	4.			2.	209.	209.		32.	111	111		78.				109.	10
12	31.0	31.0	0	.0	78.0	0	0	3.0	2.0	0	0	0	32.0	0	.0	.0	79.0	0	4.0	5.0	2.0	2.0
			219.	220	87.	6.			3.	220.	220.		36.	124	124		87.				123.	12
13	35.0	35.0	0	.0	86.0	0	0	6.0	3.0	0	0	0	35.0	0	.0	.0	85.0	0	7.0	7.0	3.0	3.0
			200.	199	78.	4.			1.	200.	199.		32.	111	111		78.				111.	11
15	32.0	32.0	0	.0	79.0	0	0	4.0	1.7	6	0	0	32.0	0	.0	.0	79.0	0	4.0	4.0	1.7	1.6
			213.	214	84.	4.			1.	217.	216.		31.	120	119		84.				119.	12
16	31.3	29.1	1	.2	84.7	2	3	4.3	1.9	9	3	0	30.3	0	.1	.6	83.5	2	4.2	4.6	2.0	2.0
			217.	221	86.	5.			2.	215.	219.		35.	122	123		86.				122.	12
17	35.6	35.4	8	.4	87.0	0	2	5.4	2.3	4	5	5	35.6	3	.2	.4	85.9	5	5.4	5.5	2.7	2.5
			235.	246	85.	6.			7.	220.	209.		37.	124	125		88.				127.	12
18	35.0	37.0	0	.0	88.0	0	1	5.2	7.5	7	0	0	36.0	0	.0	.0	94.0	0	6.5	6.6	7.8	7.4
			183.	187	72.	8.			-	0.	177.	179.		27.	105	106		71.			116.	11
19	31.0	30.0	0	.0	71.0	0	0	8.0	2.0	0	0	0	30.0	0	.0	.0	67.0	0	4.0	5.0	-1.0	-1.0
			217.	217	84.	7.			2.	219.	217.		34.	121	119		84.				121.	11
20	36.2	34.8	4	.0	84.9	4	1	8.9	1.9	7	0	1	35.1	4	.2	.0	85.8	3	5.6	5.9	2.4	2.3
			204.	204	79.3	79.	4.	4.4	1.9	2.	204.	204.	32.6	32.	111	112	78.6	78.	4.3	4.4	1.9	2.0
21	32.2	32.2	204.	204	79.3	79.	4.	4.4	1.9	2.	204.	204.	32.6	32.	111	112	78.6	78.	4.3	4.4	1.9	2.0

OIV-MA-AS313-20 : R2023

**COMPENDIUM OF INTERNATIONAL ANALYSIS OF METHODS - OIV
Sorbic, Benzoic and Salicylic acids - HPLC**

			1	.2		1	3		0	9	4		3	.9	.4		7				0	4.2			
22	34.0	34.0	216.	216		83.	6.		3.	216.	217.		34.	121	121		83.			6.0	6.0	3.0	3.0	121.	12
			0	.0	83.0	0	6.0	3.0	0	0	0	34.0	0	.0	.0	83.0	0						0	1.0	
23	35.3	35.0	219.	217		86.	4.		1.	219.	217.		35.	124	123		86.			3.9	4.1	1.6	1.8	124.	12
			3	.6	87.3	1	1	4.5	1.6	7	3	9	35.4	9	.3	.0	87.0	0					6	3.5	
24	34.2	34.0	214.	216		82.	4.		2.	215.	215.		33.	117	118		83.			4.1	4.1	2.8	2.7	119.	11
			0	.0	81.8	1	1	4.1	2.7	8	0	0	33.7	8	.0	.0	83.7	4					0	9.0	
26	35.1	35.2	214.	214		86.	5.		2.	214.	214.		35.	122	122		86.			5.1	5.1	2.2	2.2	122.	12
			4	.5	86.2	2	0	5.1	2.2	2	9	2	35.0	1	.3	.5	86.0	3					2	2.5	

TABLE 3- RESULTS FOR SORBIC ACID (mg/L)

Laboratory code	White wine		Rosé		White wine		Red wine		Fortified wine		White wine	
	A	G	B	F	C	K	D	M	E	N	I	O
1	35.90	36.00	223.50	225.00	87.00	88.50	5.25	4.65	1.75	1.90	124.50	126.00
2	33.15	32.25	209.50	209.95	81.15	80.80	4.45	5.00	2.05	2.20	115.45	116.20
3	34.30	34.40	216.15	216.75	84.60	84.40	5.25	5.70	2.40 ^(c)	2.40 ^(c)	119.95	120.35
4	34.85	34.65	223.90	221.00	88.95	86.55	5.10	5.20	2.15	2.10	123.15	123.30
6	34.45	34.65	214.70	215.30	83.95	83.75	5.58 ^(c)	6.34	1.95 ^(c)	2.08 ^(c)	120.65	120.60
7	34.50	35.00	217.50	218.00	84.50	85.00	5.50	5.00	3.00 ^(b)	2.00 ^(b)	122.50	122.00

COMPENDIUM OF INTERNATIONAL ANALYSIS OF METHODS - OIV
Sorbic, Benzoic and Salicylic acids - HPLC

8	33.65	34.55	217.65	217.15	85.00	84.25	4.50	4.20	2.00	2.00	120.45	123.90
9	32.49	32.16	197.83	196.38	80.81	79.40	3.42	3.32	1.41	1.25	112.38	113.56
10*	34.10	34.10	216.50	216.00	83.65	83.40	5.66	5.68	2.15 ^{c)}	2.13 ^{c)}	118.50	119.50
11*	36.90	36.95	228.55	224.90	90.30	88.70	4.70	4.15	2.00 ^{c)}	2.00 ^{c)}	127.20	128.25
12	31.00	32.00	204.50	209.00	78.00	78.50	3.50	4.50	2.00	2.00	111.00	109.00
13	35.00	35.50	219.50	220.00	86.50	86.00	6.00	7.00	3.00	3.00	124.00	123.00
15*	32.00	32.00	199.50	199.50	78.50	78.50	4.00	4.00	1.65	1.65	111.00	111.00
16	30.20	30.65	213.65	216.65	84.45	83.85	4.28	4.38	1.94	1.96	119.85	119.70
17	35.53	35.44	219.61	217.53	86.51	86.19	5.30	5.47	2.38	2.61	122.82	123.12
18	36.00	36.50	240.50 ^{b)}	214.50 ^{b)}	86.50 ^{b)}	91.00 ^{b)}	5.65	6.55	7.60 ^{a)}	7.60 ^{a)}	124.50	127.50
19	30.50 ^{b)}	28.50 ^{b)}	185.00 ^{a)}	98.00 ^{a)}	71.50 ^{a)}	69.00 ^{a)}	8.00 ^{b)}	4.50 ^{c)b)}	-	-1.00 ^{c)a)}	105.50 ^{b)}	115.50 ^{b)}
									1.00 ^{c)a)}			
20	35.50	34.75	217.20	218.05	84.65	85.05	8.00 ^{b)}	5.75 ^{b)}	2.30 ^{c)}	2.35 ^{c)}	120.10	120.55
21	32.20	32.45	204.15	204.65	79.20	78.65	4.36	4.36	1.94	1.94	112.15	114.60
22	34.00	34.00	216.00	216.50	83.00	83.00	6.00	6.00	3.00	3.00	121.00	121.00
23	35.15	35.65	218.45	218.60	86.70	86.50	4.30	4.00	1.65 ^{c)}	1.70 ^{c)}	123.65	124.05
24	34.10	33.75	215.00	215.00	81.95	83.55	4.10 ^{c)}	4.10 ^{c)}	2.75 ^{c)}	2.75 ^{c)}	117.50	119.00
26	35.13	35.06	214.45	214.58	86.21	86.15	5.07	5.07	2.17	2.17	122.37	122.35

a) Values rejected by Grubbs test on mean outliers

b) Values rejected by Cochran test variance outliers

**COMPENDIUM OF INTERNATIONAL ANALYSIS OF METHODS - OIV
Sorbic, Benzoic and Salicylic acids - HPLC**

c) Value identified by the laboratory below Quantification Limit

TABLE 4 - PRECISION DATA

Indicators	White wine (A/G)	Rosé (B/F)	White wine (C/K)	Red wine (D/M)	Fortified wine (E/N)	White wine (I/O)
Number of laboratories	22	21	21	21	20	22
Number of repetitions	2	2	2	2	2	2
Minimum (mg/L)	30.20	196.38	78.00	3.32	1.25	109.00
Maximum (mg/L)	36.95	228.55	90.30	7.00	3.00	128.25
Repeatability variance s_r^2	0.0942	1.5249	0.4191	0.1201	0.0037	0.9397
Intergroup variance s_L^2	2.6370	55.1140	9.7049	0.6418	0.1793	22.4914
Reproducibility variance s_R^2	2.7312	56.6389	10.1240	0.7619	0.1830	23.4311

COMPENDIUM OF INTERNATIONAL ANALYSIS OF METHODS - OIV
Sorbic, Benzoic and Salicylic acids - HPLC

Average (mg/L)	34.16	214.72	83.96	4.92	2.15	120.07
Repeatability standard deviation (mg/L)	0.31	1.23	0.65	0.35	0.06	0.97
Repeatability limit (mg/L)	0.869	3.495	1.832	0.981	0.172	2.743
Repeatability RSD %	0.9	0.6	0.8	7.0	2.8	0.8
Reproducibility standard deviation (mg/L)	1.65	7.53	3.18	0.87	0.43	4.84
Reproducibility limit (mg/L)	4.677	21.298	9.005	2.470	1.211	13.699
Reproducibility RSD %	4.8	3.5	3.8	17.7	19.9	4.0
HORRAT	0.5	0.5	0.5	1.4	1.4	0.5

FIGURE 1 – CORRELATION BETWEEN SORBIC ACID CONCENTRATION AND PRECISION

COMPENDIUM OF INTERNATIONAL ANALYSIS OF METHODS - OIV
Sorbic, Benzoic and Salicylic acids - HPLC

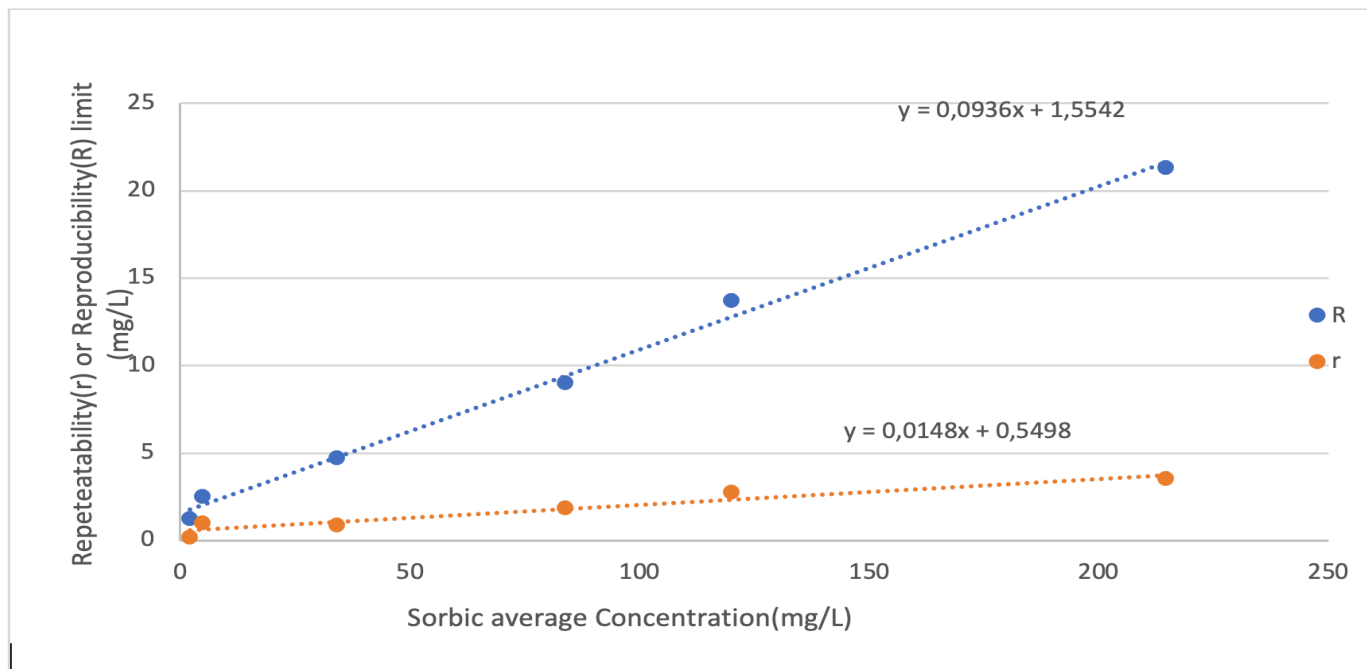

COMPENDIUM OF INTERNATIONAL ANALYSIS OF METHODS - OIV
Sorbic, Benzoic and Salicylic acids - HPLC

FIGURE 2 - Z-SCORES REPRESENTATION WITHOUT OUTLIERS

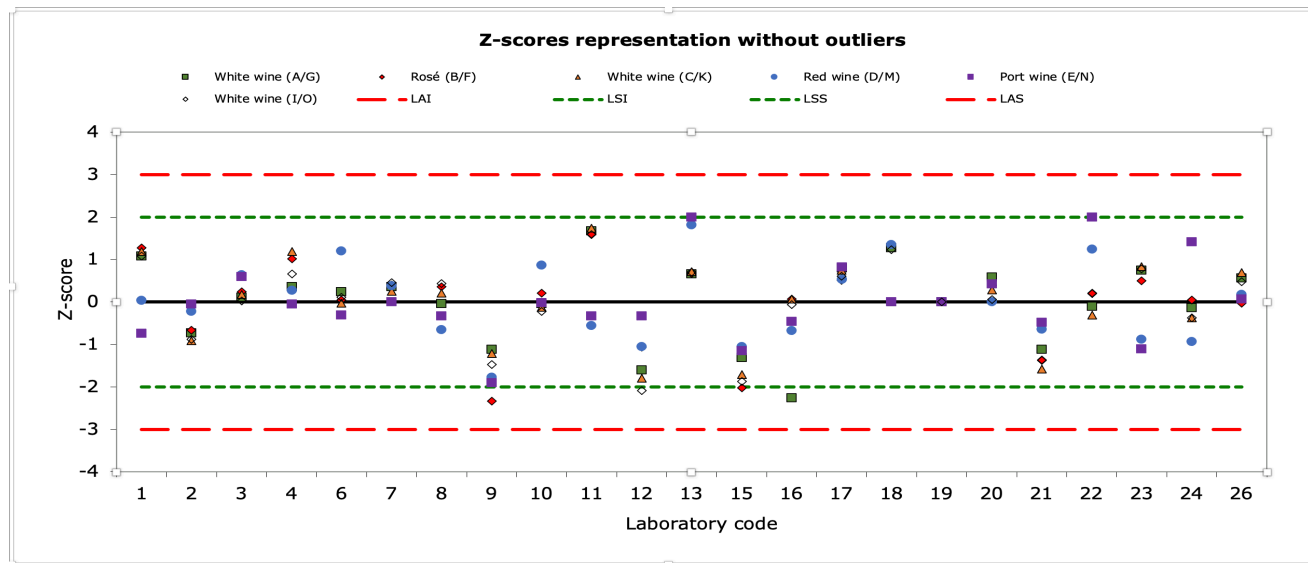

*LAI -lower action limit; LAS - upper action limit; LSI - lower warning limit; LSS - upper warning

Bibliography

- - Dosage de l'acide sorbic dans les vins par chromatographie en phase gazeuse. 1978. BERTRAND A. et SARRE Ch., *Feuillets Verts O.I.V.*, 654-681.
 - - Dosage de l'acide salicylic dans les vins par chromatographie en phase gazeuse. 1978. BERTRAND A. et SARRE Ch., *Feuillets Verts O.I.V.*, 655-682.
- Dosage de l'acide benzoic, dans les sodas et autres produits alimentaires liquides, par chromatographie en phase gazeuse. 1978. BERTRAND A. et SARRE Ch. *Ann. Fals. Exp. Chim.* 71, 761, 35-39.

Method OIV-MA-AS313-21

Type IV method

Determination of the presence of metatartaric acid

(Resolution OENO 10/2007; OIV/OENO 377/2009)

1. Introduction

Metatartaric acid added to the wine to avoid tartaric precipitation is traditionally proportioned by the difference between the total tartaric acid following hot hydrolysis of metatartaric acid and natural tartaric acid preceding hydrolysis. However, taking into account the precision of the determination of tartaric acid, traces of metatartaric acid are not detectable by this method, and the additive, which is not accepted in certain countries, must therefore be characterised using a more specific method.

2. Scope

Wines likely to contain traces of metatartaric acid.

3. Principle

In relatively acid mediums, metatartaric acid forms an insoluble precipitate with cadmium acetate; it is the only one of all the elements present in must and wine to give such a precipitate .

Note: Tartaric acid is also precipitated with cadmium acetate, but only in the presence of an alcohol content greater than 25% vol. The precipitate redissolves in water, unlike the precipitate obtained with metatartaric acid.

The cadmium precipitate of metatartaric acid breaks down by heating with sodium hydroxide and releases tartaric acid. The latter produces a specific orange colour with ammonium metavanadate.

4. Reagents

- 4.1 Cadmium acetate solution at 5 p.100
 - 4.1.1 Dihydrated cadmium acetate at 98%
 - 4.1.2 Pure acetic acid
 - 4.1.3 Distilled or demineralized water

**COMPENDIUM OF INTERNATIONAL ANALYSIS OF METHODS -
OIV
Metatartaric acid**

- 4.1.4 Cadmium acetate solution: dissolve 5 g of cadmium acetate (4.1.1) in 99 mL of water (4.1.3) add 1 mL of pure acetic acid (4.1.2)
- 4.2 Sodium hydroxide 1M
- 4.3 Sulfuric acid 1M
- 4.4 Solution of ammonium metavanadate 2% w/v
 - 4.4.1 Ammonium metavanadate
 - 4.4.2 Trihydrated sodium acetate at 99%
 - 4.4.3 Sodium acetate solution at 27 p. 100: dissolve 478 g of sodium acetate (4.4.2) in 1 liter of water (4.1.3)
 - 4.4.4 Solution of ammonium metavanadate: dissolve 10 g of ammonium metavanadate (4.4.1) in 150 mL of sodium hydroxide 1 M (4.2) add 200 of the sodium acetate solution at 27 p. 100 (4.4.3) and fill to 500 mL with water (4.1.3)
- 4.5 Ethanol at 96% vol.

5. Apparatus

- 5.1 Centrifuge with a rotor capable of housing 50-mL bottles
- 5.2 Spectrometer capable of operating in the visible spectrum and of housing cuvetts with an optical thickness of 1 cm.

6. Operating method

- 6.1 Centrifuge 50 mL of wine for 10 minutes at 11000 rpm
- 6.2 Take 40 mL of limpid wine using a test-tube and place the sample in a centrifuge flask
- 6.3 Add 5 mL of ethanol at 96% vol (4.5)
- 6.4 Add 5 mL of the cadmium acetate solution (4.1.4)
- 6.5 Mix and leave to rest for 10 minutes
- 6.6 Centrifuge for 10 minutes at 11000 rpm
- 6.7 Decant by completely reversing the flask (once) and throw away the supernatant.

In the presence of metatartaric acid, a lamellate precipitate is formed at the bottom of the tube.

In the absence of any precipitate, the sample will be regarded as free from metatartaric acid. In the contrary case, or if the presence of a light precipitate is to be established with certainty, proceed as follows:

**COMPENDIUM OF INTERNATIONAL ANALYSIS OF METHODS -
OIV
Metatartaric acid**

- 6.8 Wash the precipitate once with 10 mL of water (4.1.3) in the form of an energetic jet towards the bottom of the tube in order to detach the precipitate from the bottom
- 6.9 Add 2 mL of cadmium acetate solution (4.1.4)
- 6.10 Centrifuge at 11000 rpm for 10 minutes then throw away the supernatant by completely reversing the tube (once)
- 6.11 After adding one mL of sodium hydroxide 1M (4.2), plunge the tube to be centrifuged for 5 minutes in a water bath at 100° C
- 6.12 After cooling, add 1 mL of sulfuric acid 1M (4.3) and 1 mL of ammonium metavanadate solution (4.4.4)
- 6.13 Wait 15 minutes
- 6.14 Centrifuge for 10 minutes at 11000 rpm
- 6.15 Pour the supernatant into a spectrophotometer tank and measure the absorbance at 530 nm, after determining the zero point with water (4.1.3)

i.e. Abs_E

Standard. In parallel, produce a standard comprising the same wine as that analyzed but heated beforehand for 2.5 minutes using a microwave generator set to maximum power or with a water bath at 100° C for 5 minutes.

i.e. Abs_T

7. Calculation

The presence of metatartaric acid in the wine is established when, at 530 nm:

$$\text{Abs}_E - \text{Abs}_T > 0.050$$

**Simultaneous determination of L-ascorbic acid and
D-iso-ascorbic acid (erythorbic acid) in wine
by HPLC and UV-detection
(Resolution OENO 11/2008)**

1. Introduction

Ascorbic acid is an antioxidant that is naturally occurring in a wide range of foods. The natural amount of ascorbic acid in grapes decreases during must and wine production, but it can be added to musts and to wines within certain limits.

The method described has been validated in a collaborative study by the analyses of wine samples with spiked amounts of 30 mg/L to 150 mg/l for L-ascorbic acid and 10 mg/L to 100 mg/l for D-isoascorbic acid respectively.

2. Scope

This method is suitable for the simultaneous determination of L-ascorbic acid and D-iso-ascorbic acid (erythorbic acid) in wine by high performance liquid chromatography and UV-detection in a range of 3 mg/L to 150 mg/l.

For contents above 150 mg/l, sample dilution is necessary.

3. Principle

The samples are directly injected into the HPLC system after membrane filtration. The analytes are separated on a reversed phase column and UV-detection at 266 nm. The quantification of L-ascorbic acid and D-iso-ascorbic acid is done with reference to an external standard.

Note: The columns and operating conditions are given as example. Other types of columns may also give a good separation.

4. Reagents and Material

4.1 Reagents

- 4.1.1. N-octylamine, puriss. ≥ 99.0 %
- 4.1.2. Sodium acetate, 3 H₂O, puriss ≥ 99.0 %
- 4.1.3. Pure acetic acid, 100 %
- 4.1.4. Phosphoric acid, approx. 25%
- 4.1.5. Oxalic acid, puriss. ≥ 99.0 %

**COMPENDIUM OF INTERNATIONAL METHODS OF ANALYSIS -
OIV**

L-ascorbic acid and D-iso-ascorbic acid

- 4.1.6. Ascorbate oxidase
- 4.1.7. L-ascorbic acid, ultra $\geq 99.5\%$
- 4.1.8. D-iso-ascorbic acid, puriss. $\geq 99.0\%$
- 4.1.9. Bi-distilled water
- 4.1.10. Methanol, p.A. 99.8%

4.2 Preparation of the mobile phase

4.2.1 Solutions for the mobile phase

For the mobile phase prepare the following solutions:

- 4.2.1.1 12.93 g n-octylamine in 100 ml methanol
- 4.2.1.2 68.05 g sodium acetate, 3 H₂O in 500 ml bi-distilled water
- 4.2.1.3 12.01 g pure acetic acid in 200 ml bi-distilled water
- 4.2.1.4 Buffer solution (pH 5.4) : 430 ml sodium acetate solution (4.2.1.2) and 70 ml acetic acid solution (4.2.1.3)

4.2.2 Preparation of the mobile phase

Add 5 ml of n-octylamine solution (4.2.1.1) to approximately 400 ml bi-distilled water in a beaker. Adjust this solution to a pH of 5.4 to 5.6 by adding 25% phosphoric acid (4.1.4.) drop by drop. Add 50 ml of the buffer solution (4.2.1.4), transfer the composite mix to a 1000 ml volumetric flask and fill up with bi-distilled water. Before use, the mobile phase has to be filtered through a membrane (regenerated cellulose, 0.2 μm) and if possible degassed with helium (approximately 10 minutes) depending on the needs of the HPLC system used.

4.3 Preparation of the standard solution

Note: All standard solutions (stock solution 4.3.1. and working solutions 4.3.2) have to be prepared daily and preferably stored cold in a refrigerator prior to injection.

4.3.1 Preparation of the stock solution (1 mg/ml)

Prepare a 2% aqueous oxalic acid solution and eliminate dissolved oxygen by blowing through nitrogen.

Weigh exactly 100 mg each of L-ascorbic acid and D-iso-ascorbic acid in a 100 ml volumetric flask and make to the mark with the 2% aqueous oxalic acid solution.

4.3.2 Preparation of the working solutions

For the working solutions dilute the stock solution (4.3.1) to the desired concentrations with the 2% oxalic acid solution. Concentrations between 10 mg/l and 120 mg/l are recommended, e.g. 100 μl , 200 μl , 400 μl , 800 μl , 1200 μl to 10 ml, corresponding to 10, 20, 40, 80 and 120 mg/l.

5. Apparatus

Usual laboratory equipment, in particular the following:

5.1 HPLC-pump

5.2 Loop injector, 20 µl

5.3 UV-detector

6. Sampling

Wine samples are filtered through a membrane with pore size 0.2 µm before injection.

For contents above 150 mg/L, it is necessary to dilute the sample.

7. Procedure

7.1 Operating conditions for HPLC

Inject 20 µl of the membrane-filtered sample into the chromatographic apparatus.

Precolumn:	e.g. Nucleosil 120 C18 (4cm x 4 mm x 7 µm)
Column:	e.g. Nucleosil 120 C18 (25 cm x 4 mm x 7 µm)
Injection Volume:	20 µl
Mobile Phase:	see 4.2.2, isocratic
Flow rate:	1ml/min
UV-detection:	266 nm
Rinse cycle:	at least 30ml bi-distilled water followed by 30ml methanol and 30ml acetonitrile

7.2 Identification/Confirmation

Identification of peaks is done by the comparison of retention times between standards and samples. With the chromatographic system described as an example, the retention times are: for L-ascorbic acid 7.7 min. and for D-iso-ascorbic 8.3 min. respectively. (See figure 1, chromatogram A).

For further confirmation of positive findings these samples should be treated with a spatula of ascorbate oxidase and measured again (see figure 1, chromatogram B). As a result of the degradation of L-ascorbic acid and D-iso-ascorbic acid caused by the ascorbate oxidase, no signal should be found at the retention time of L-ascorbic acid and D-iso-ascorbic acid. If interfering peaks are detected, their peak area should be taken into account for the calculation of the concentration of the analytes.

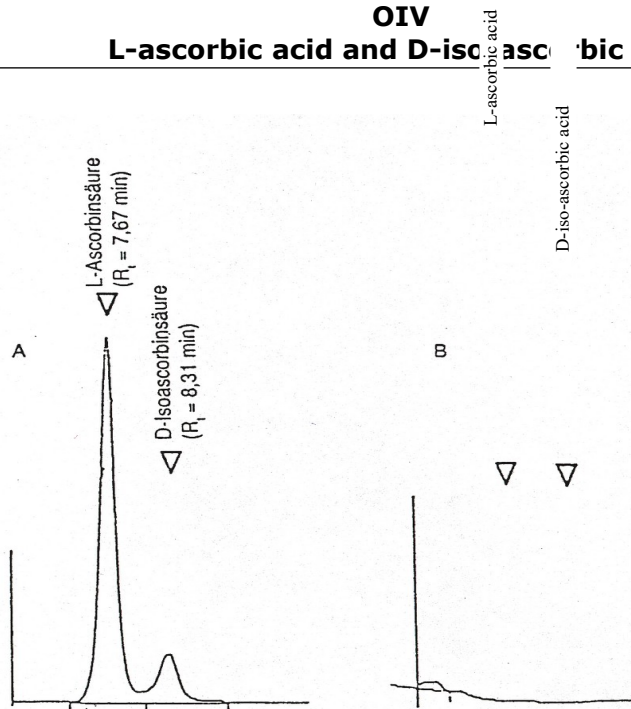

Figure 1: Example of a chromatogram of white wine: A: prior to treatment with ascorbate oxidase; B: after treatment

Note: It is recommended to analyse the ascorbate oxidase treated samples at the end of a sequence, followed by the rinse cycle for removing remaining ascorbate oxidase from the column. Otherwise the L-ascorbic acid and the D-isoascorbic acid may be converted by the remaining ascorbate oxidase during the HPLC-measurement and the result may be altered.

8 Calculation

Prepare a calibration curve from the working solutions (4.3.2). Following the method of external standard the quantification of L-ascorbic acid and D-isoascorbic acid is performed by measuring the peak areas and comparing them with the relevant concentration in the calibration curve.

Expression of results

The results are expressed in mg/l L-ascorbic acid and D-isoascorbic acid respectively with one decimal (e.g. 51,3 mg/l).

For contents above 150 mg/L, take into account the dilution.

9. Precision

The method was tested in a collaborative study with 27 laboratories participating, organised by the former Bundesgesundheitsamt (Germany) in 1994. The design of the

collaborative trial followed the § 35 of the German Food Law that has been accepted by the O.I.V until the new protocol (OENO 6/2000) was introduced.

The study included four different samples of wine - two white wines and two red wines - of which five repetitions of each were requested. Due to the fact that it was not possible to prepare samples with a sufficient stability of the analytes (different degradation rates) it was decided to send defined amounts of pure standard substances together with the wine samples to the participants. The laboratories were advised to transfer the standards quantitatively to the wine samples and to analyse them immediately. Amounts of 30 to 150 mg/l for L-ascorbic acid and 10 to 100 mg/l for D-iso-ascorbic acid were analysed. In the Annex the detailed study results are presented. Evaluation was done following the DIN/ISO 5725 (Version 1988) standard.

The standard deviations of repeatability (s_r) and reproducibility (s_R) were coherent with the L-ascorbic acid and D-iso-ascorbic acid concentrations. The actual precision parameters can be calculated by the following equations:

L-ascorbic acid

$$s_r = 0.011 x + 0.31$$

$$s_R = 0.064 x + 1.39$$

x: L-ascorbic acid concentration (mg/l)

D-iso-ascorbic acid

$$s_r = 0.014 x + 0.31$$

$$s_R = 0.079 x + 1.29$$

x: D-iso-ascorbic acid concentration (mg/l)

Example:

D-iso-ascorbic acid 50 mg/l

$$s_r = 1.0 \text{ mg/l}$$

$$s_R = 5.2 \text{ mg/l}$$

10. Other characteristics of the analysis

10.1 Limit of detection

The limit of detection of this method was estimated at 3mg/l for L-ascorbic acid and D-iso-ascorbic acid

10.2. Trueness

The mean recovery calculated from the collaborative trial over four samples (see Annex) was:

100.6 % for L-ascorbic acid

103.3 % for D-iso-ascorbic acid

**COMPENDIUM OF INTERNATIONAL METHODS OF ANALYSIS -
OIV**

L-ascorbic acid and D-iso-ascorbic acid

11. ANNEX: Collaborative Trial

L-Ascorbic Acid

		Red Wine I	White Wine II	Red Wine III	White Wine IV
X	mg/l	152.7	119.8	81.0	29.9
Amount spiked	mg/l	150	120	80	30
Recovery	%	101.8	99.8	101.3	99.7
n		25	23	25	23
Outliers		1	3	1	3
Repeatability s_r	mg/l	1.92	1.55	1.25	0.58
RSD _r	%	1.3	1.3	1.5	1.9
HorRat		0.17	0.17	0.19	0.20
r	mg/l	5.4	4.3	3.5	1.6
Reproducibility S_R	mg/l	10.52	10.03	6.14	3.26
RSD _R	%	6.9	8.4	7.6	10.9
Horwitz RSD _R	%	7.5	7.8	8.3	9.6
HorRat		0.92	1.08	0.92	1.14
R	mg/l	29.5	28.1	17.2	9.1

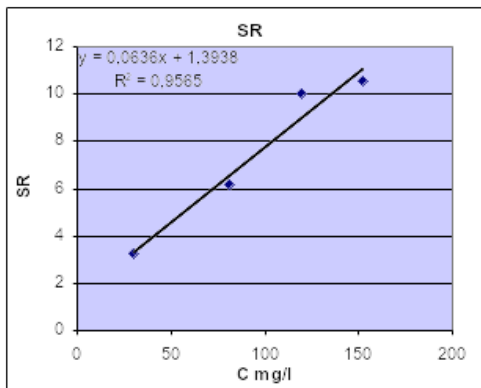
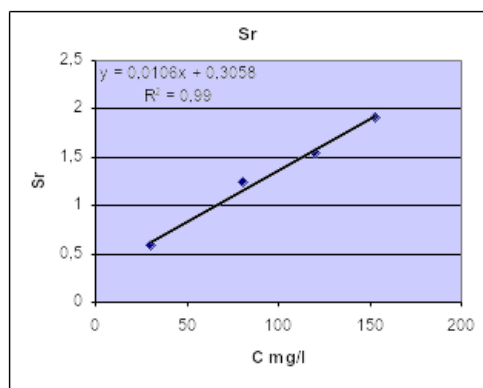

**COMPENDIUM OF INTERNATIONAL METHODS OF ANALYSIS -
OIV**

L-ascorbic acid and D-iso-ascorbic acid

D-Isoascorbic Acid

		Red Wine I	White Wine II	Red Wine III	White Wine IV
X	mg/l	102.4	79.8	11.3	29.4
Amount Spiked	mg/l	100	80	10	30
Recovery	%	102.4	99.8	113.0	98.0
n		25	23	24	22
Outliers		1	3	2	4
Repeatability s_r	mg/l	1.71	1.49	0.47	0.70
RSD _r	%	1.7	1.9	4.1	2.4
HorRat		0.21	0.23	0.37	0.25
r	mg/l	4.8	4.2	1.3	2.0
Reproducibility S_R	mg/l	9.18	7.96	2.394	3.23
RSD _R	%	9.0	10.0	21.2	11.0
Horwitz RSD _R	%	8.0	8.3	11.1	9.6
HorRat		1.12	1.21	1.91	1.14
R	mg/l	25.7	22.3	6.7	9.0

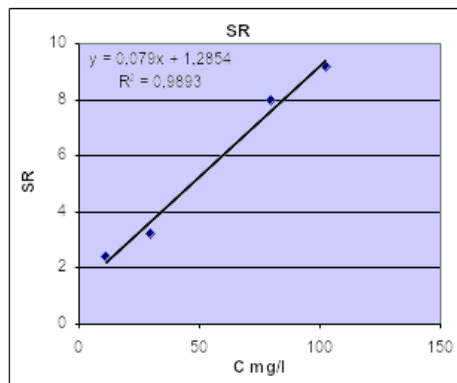
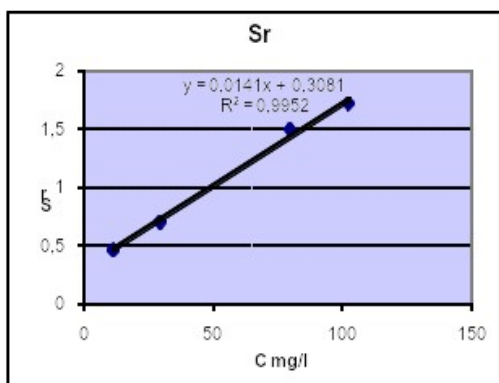

12. Bibliography

B. Seiffert, H. Swaczyna, I. Schaefer (1992): Deutsche Lebensmittelrundschau, 88 (2) p. 38-40

C. Fahl: Simultaneous determination of L -ascorbic acid and D –iso-ascorbic acid (erythorbic acid) in wine by HPLC and UV-detection – OIV FV 1228, 2006

Method OIV-MA-AS313-23

Type IV method

**Identification of L- tartaric acid as being of plant or fossil origin
by measuring its ¹⁴C activity**
(Resolution OENO 12/2008)

1. PURPOSE AND SCOPE

The method can be used to identify tartaric acid as being of plant or fossil origin, and in cases of a mixture of the two, to determine the respective proportions of the two types. In these situations, the method enables the detection of fossil-derived L(+)-tartaric acid quantities below 10%.

2. PRINCIPLE

In the majority of cases, commercially available tartaric acid of plant origin is a product of winemaking. The potassium hydrogéntartrate present in the lees is extracted and marketed in the form of L-tartaric acid. The ¹⁴C concentration in the acid is therefore related, as with ethanol from wine, to the ¹⁴C concentration in the carbon dioxide in wines from the same year of production. This concentration is relatively high as a result of the human activity involved.

Synthetic tartaric acid on the other hand, derived from fossil fuel by-products, has a much lower or even negligible concentration of ¹⁴C.

Measuring the ¹⁴C activity in DPM/gram of carbon (Disintegrations Per Minute) using liquid scintillation therefore allows the origin to be determined as well as any combination of the types.

3. REAGENTS AND PRODUCTS

3.1 Reagents

3.1.1 Scintillation fluid such as Instagel Plus

3.1.2 ¹⁴C toluene reference with activity certified by laboratory for callibration, for calculating the sensitivity and efficiency of the machine by the definition of a quench curve

3.1.3 ¹⁴C and ³H standards and ¹²C toluene for the background noise, for calibrating the scintillation counter

3.1.4 Nitromethane 99%

3.1.5 Ultrapure water (>18 MΩ)

3.1.6 ¹⁴C toluene solution with activity of approx. 430 DPM/ml obtained by diluting stock ¹⁴C reference solution in ¹²C toluene.

3.2 Standards

3.2.1 Defining the quench curve

Once the scintillator has been calibrated using the three certified ¹⁴C, ³H and ¹²C toluene standards, plot a quench curve using the following procedure.

Prepare a dozen vials with 10 ml of a solution of 500 g/l of fossil-derived L-tartaric acid in water, then add the quantity of toluene ¹⁴C standard needed for approx. 400-1000 DPM in total per vial (if necessary, make up an intermediate solution of standard solution in toluene), then add increasing quantities of nitromethane, e.g. for 12 vials: 0, 0, 0, 5, 10, 15, 20, 35, 50, 100, 200 and 400 μL followed by 10 ml of scintillation fluid. There must be at least 3 samples containing no nitromethane.

Define a quench curve once a year, analysing the vials in increasing order of nitromethane content.

The quench curve can then be used to determine the sensitivity or mean efficiency.

3.2.2 Determination of background noise (test blank)

Using fossil-derived L-tartaric acid, such as that used for calculating the efficiency, determine the background noise, or test blank value. This test should be performed immediately after defining the quench curve, then roughly every three months.

3.2.3 Defining the calibration curve

The purity of the plant and fossil-derived L-tartaric acids must be checked using HPLC before the scintillation test is done.

Calibration using a mixture of tartaric acid (which is known with certainty to be of plant origin) containing between 0% and 100 % of this type in combination with the fossil-derived type.

COMPENDIUM OF INTERNATIONAL ANALYSIS OF METHODS - OIV
Identification of L- tartaric acid

Preparation of 500 g/l solutions			
	Blank or background noise	Standards	Internal standard
Weighing	respectively in 50 ml volumetric flasks		
	25 g fossil-derived L-tartaric acid	25 g known combinations of fossil and plant L-tartaric acid	Use the blank
Dissolution	Seal		
	Homogenise the mixture well by shaking and/or tumbling		
Preparation of scintillation mixtures			
	In plastic vials, add respectively		
Sample taken from the 500 g/l solutions	10 ml using volumetric pipettes		
Added concentration	////	////	100 µL
Added scintillation fluid	10 ml using an automatic burette		
	Screw the cap on		
	Wait 5 min. then analyse for 500 min.		

3.3. Internal control

3.3.1 Nature of product used for internal control

A 500 g/l solution of fossil-derived L-tartaric acid is enriched with a quantity of toluene ¹⁴C (DPM<100)

The background noise should be determined using the same fossil-derived L-tartaric acid solution.

3.3.2 Nature of internal control

Measurement of the added concentration provides verification that there is no spectral interference in the medium being studied.

3.3.3 Internal control limits

The control limits depend on the equipment used: a 5% value is acceptable.

3.3.4 Inspection frequency and procedure

Once a month during frequent use, or at each analysis sequence, an internal control is performed on the scintillator. The same check is also carried out at every change of scintillation fluid batch or after a new quench curve has been defined.

3.3.5 Decision rules to be taken depending on the results of the internal control

If the results fall outside the internal control limits, calibrate the scintillator after checking the protocol, then repeat the internal control.

If the calibration is accurate but the new internal control measurement is not, make a new quench curve and carry out a new control.

4. APPARATUS

4.1 Liquid scintillation spectrometre with computer and printer previously calibrated with quenching curve established with nitromethane

4.2 Low content potassium identical bottles (40K) with screw top stopper, and low background noise

4.3 10 mL 2 graduations pipettes

4.4 Automatic distribution burette adapted to screw top for liquid scintillating bottle

4.5 Glass laboratory

1) 5. SAMPLES

The purity of the samples can be checked using HPLC if required, before running the scintillation analysis.

Make up a 500 g/solution of the sample to be analysed in ultra-pure water.

**COMPENDIUM OF INTERNATIONAL ANALYSIS OF METHODS - OIV
Identification of L- tartaric acid**

Preparation of 500 g/l solutions				
	Test blank or background noise	Standards	Internal standard	Sample
Weighing	respectively in 50 ml volumetric flasks			
	25 g fossil-derived L-tartaric acid	25 g known combinations of fossil-derived and plant L-tartaric acid	Use the blank	25 g
Dissolution	Seal			
	Homogenise the mixture well by shaking and/or tumbling			
Preparation of scintillation mixtures				
	In plastic vials, add respectively			
Sample taken from the 500 g/l solutions	10 ml using volumetric pipettes			
Added concentration	////////// /	//////////	100 µL	//////////
Added scintillation fluid	10 ml using an automatic burette			
	Screw the cap on and shake hard			
	Wait 5 min. then analyse for 500 min.			
Notes	Every 5 to 10 test samples, run a sample with 0 % plant tartaric acid, i.e. 10 ml fossil tartaric acid and 10 ml scintillation fluid.			
	Measure the background noise at the end of each analysis sequence			

6. CALCULATION

Measurements are given directly in Counts Per Minute CPM, but these must be converted to DPM/gram of carbon.

6.1 Results:

Calculation of the specific ¹⁴C radioactivity of the sample in DPM/gram of carbon:

$$A = \frac{(X - X') \times 100 \times 3.125(d)}{Rm \times m}$$

- **A:** radioactivity in disintegrations/minute and per gram of carbon
- **X:** CPM of the sample
- **X':** CPM for the fossil L-tartaric acid used for the background noise
- **m:** mass of the tartaric acid in the 10 ml sample from the 500 g/l solution, i.e. in 5 g of acid
- **Rm:** the mean efficiency expressed as a percentage

(1) There are 3.125 grams of tartaric acid to each gram of carbon (ratio of the molar mass of the acid (150 g/mol) to the total mass of carbon (or $4 \times 12 = 48$ g/mol))

The result is expressed to one decimal place.

6.2 Verification of the results using internal controls:

The check should be carried out by comparing the value obtained at § 3.5.1 with the result given by the added concentration method. If the difference is significant (> 5 %), recalculate the DPM value from the CPM value as below:

$$\text{Recalculated DPM} = \frac{CPM}{Rm}$$

with the mean efficiency being obtained from the quench curve.

The two results must not differ by more than 5% from their mean value. If they do, repeat the analysis on the sample, doubling the quantity of the internal standard. Compare the 2 results obtained with the standards: if they do not differ by more than 5 % from the mean of the 2, give the mean result.

Note: in this case, that would mean that the quenching of the sample is so great that direct analysis cannot be used.

6.3 Uncertainty

The uncertainty value obtained under standard test conditions is +/- 0.7 DPM/gram of carbon.

7. VALIDATION BY COMPARISON WITH A REFERENCE METHOD

7.1 Principle

Tartaric acid is converted to CO₂ by combustion then converted to benzene;
Measurement is then carried out using liquid scintillation.

After undergoing a pre-treatment designed to eliminate any contamination, the CO₂ from the sample is converted to benzene following the reaction chain below:

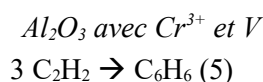
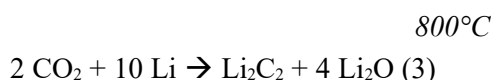
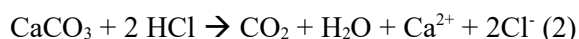
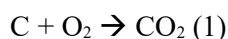

(1) Organic sample: the carbon flushed with oxygen plus a heat source (or by combustion in the presence of pressurised oxygen) produces carbon dioxide from the sample (CO₂).

(2) Mineral sample (marine or continental carbonates, water, etc.): The carbonate is attacked by pure hydrochloric acid (HCl) to produce the carbon dioxide (CO₂) from the sample plus water and ionised calcium.

(3) The action of the CO₂ on lithium metal heated to between +600°C and +800°C produces lithium carbide and lithium oxide (-Li₂ O).

(4) The action of water (hydrolysis) on the lithium carbide produces acetylene (C₂H₂), lithium hydroxide. Non-tritiated, radon-free water must be used.

(5) Trimerisation of the acetylene over a chrome-plated aluminium-based catalyst support at approx. 185 °C produces benzene (C₆H₆).

7.2 Procedure:

The carbon dioxide (CO₂) from a sample, obtained either by burning, combustion or acid attack, is preserved in a storage cylinder. The necessary quantity of lithium (lithium = catalyst for a chemical transformation) is placed in a nickel capsule, which is then placed at the bottom of a heat reaction chamber. A vacuum is created inside the chamber and its lower part is heated while its upper part is cooled at the sides with the help of a water circulation partition.

7.2.1 Carburisation.

After approximately one hour of heating, the temperature reaches 650°C. The CO₂ can then be brought into contact with melted lithium. The quantity of lithium is always higher in relation to the quantity of carbon in the sample. The excess amount of lithium to use in relation to the **stoichiometric** conditions varies from 20% to 100% according to different sources.

The chemical reaction (carburisation or "pickup") is almost instantaneous and the first few minutes of pickup are the most crucial in the carburisation process.

The reaction is **exothermic** (an increase of 200°C). Carburisation is quite rapid and is considered to be at the carburised stage after the first 20 minutes, but heating continues for 45 to 50 minutes in order to any eliminate traces of **radon** (a by-product of uranium), which could be mixed in with the carbon dioxide.

7.2.2 Cooling

Once the treatment period (heating) is complete, the reaction chambers are allowed to cool until they reach room temperature (25-30°C).

7.2.3 Hydrolysis of Lithium Carbide

Water is introduced into the reaction chambers, in a much higher quantity than that required by the reaction (1.5 L). The chemical reaction is instantaneous and the acetylene is released at the same time. This reaction is also exothermic (temperature increase between +80°C and +100°C).

The acetylene produced is then brought to a vapour state (sublimation) and trapped over the chrome-plated (Cr³⁺) aluminium catalyst support. This is previously air dried for a minimum of three hours, then vacuum dried for two hours under heat at +380°C. Drying is vital in order to eliminate any water remaining in the catalyst support balls.

7.2.4 Trimerisation - Polymerisation of acetylene to benzene by catalysis

Before trimerisation, the temperature of the catalyst support must have dropped to between +60°C and +70°C, and since this reaction is also exothermic, automatic temperature maintenance is needed. The catalyst support is then reheated to +180°C for 1½ hours and the vaporised **benzene** is desorbed then trapped in a trap tube surrounded by liquid nitrogen. Desorption takes place under dynamic vacuum. At the end of the experiment, the crystallised benzene is left to reheat to room temperature so that it regains its liquid state before being used for the counting.

7.3 Benchtop arrangement for the synthesis of Benzene

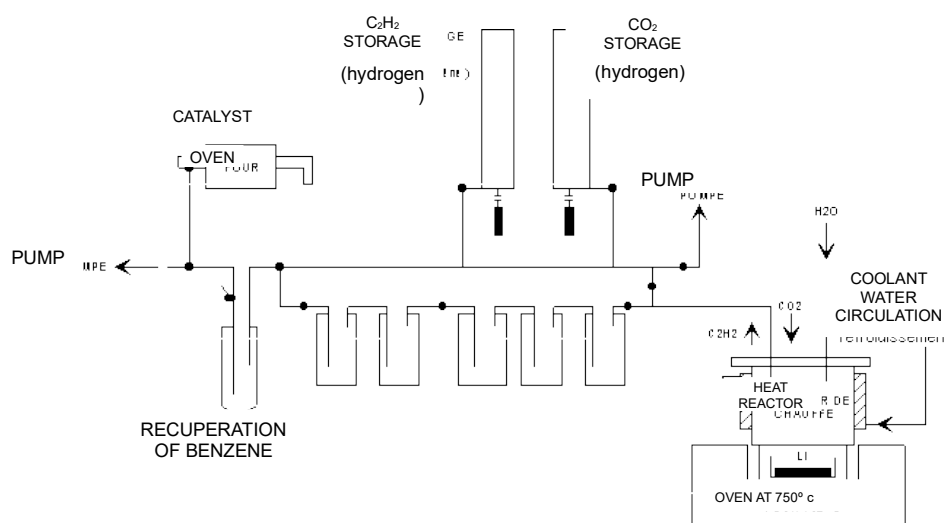

7.4 Reference Chemical solution for the Counting

A **solution volume set at 4 ml** is used as the reference for the liquid scintillation counting.

The solution comprises a target base of 3.52g benzene from the sample (solvent) + the scintillation fluid (solute) made up of 2 scintillation fluids, one main and one secondary.

Since the mass per volume of benzene is 0.88 g/litre, **0.88 x 4ml = 3.52 g**.

Main scintillation fluid	Buthyl-PBD
Chemical composition	(2-(4-Biphenyl)-5-(4-tert-buthyl-phenyl)-1,3,4-oxadiazole)
Maximum wavelength fluorescence	367 nanometers
Secondary scintillation fluid	bis-MSB
Chemical composition	1,4-Di-(2-Methylstyryl)-Benzene
Maximum wavelength fluorescence	415 nanometers
Optical absorption and coupling emission of the two fluids:	
Maximum absorption wavelength	409 nanometers
Maximum absorption wavelength	412 nanometers

7.5 Delta ¹³C correction for Isotope Fractionation

The measurement involves a correction for isotope fractionation using the standardisation procedure with a stand PDB ¹³C with a value of - 25 o/oo.

8. CHARACTERISTICS OF THE METHOD

8.1 Procedure

One sample of wine-derived tartaric acid and one sample of synthetic acetic acid were used to prepare test tartaric acid solutions at 500 g/l.

The concentrations of the wine-derived tartaric acid in the solutions varied between 0°C and 100%.

The origin and purity of the two starter samples had been previously checked using the reference method.

COMPENDIUM OF INTERNATIONAL ANALYSIS OF METHODS - OIV
Identification of L- tartaric acid

8.2 Results:

The results are given in the table and diagram below:

% OF WINE-DERIVED TARTARIC ACID		
Alternative method		
¹⁴ C activity related to concentrations of fossil-derived L-tartaric acid		
Carbon activity (in dpm / gram of carbon)	METHOD	METHOD
0	0 and 0	0
Y = 0.159x + 0.2543 R ² = 0.9917	nd 6.0	12
	nd 12	22
	d 25.4	31
	nd 38	40
40	41.4 and 50.6	50
50	57.8 and 58.8	63
60	60 and 63.3	70
70	81	81
80	84	86
85	88	91
90	94	96
95	100	100
100	100	100

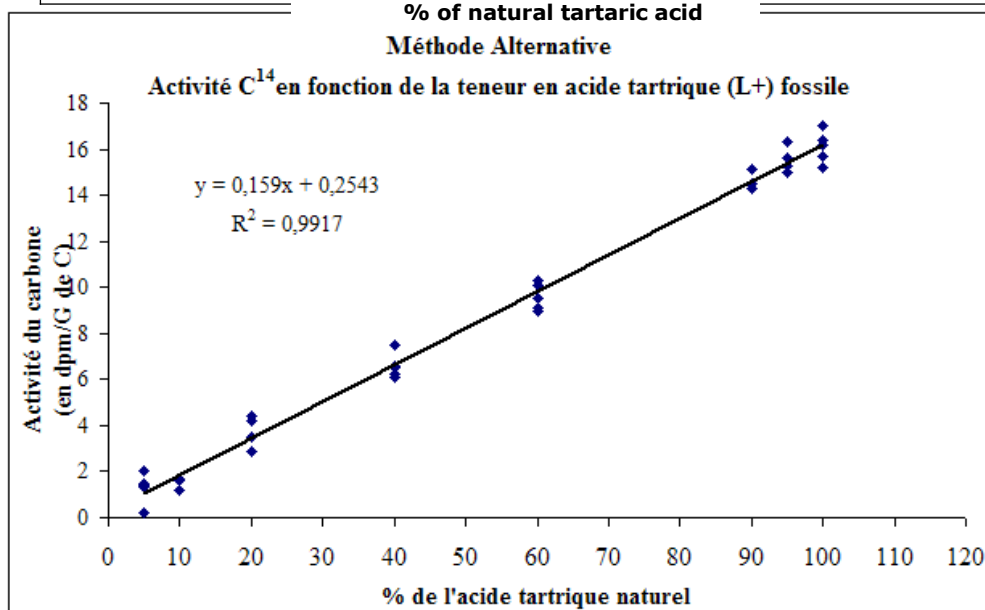

8.3 Accuracy, trueness:

Accuracy is 6.9%.

The standard deviation of repeatability for the alternative method is: 2.86 % of plant tartaric acid.

9. BIBLIOGRAPHY

Compendium of international methods of analysis of spirits and alcohols and of the aromatic fraction of beverages, Office Internationale de la Vigne et du Vin, Edition officielle, juin 1994, page 201, 204, 210 et 307.

Methods of analysis for neutral alcohol applicable to the wine sector, EEC Regulation no. 625/2003, 2 April 2003, Journal Officiel des communautés européennes 15 May 1992, n°L130, p18. (Journal Officiel, 8 April 2003, N° L90, p4).

J. GUERAIN and S. TOURLIERE, Radioactivité carbone et tritium dans les alcools, Industries Alimentaires et Agricoles – 92nd year, July – August 1975, N° 7-8

S. COHEN, B. CRESTO, S. NACHAMPASSAK, T. PAYOT, B. MEDINA, S. CHAUVET, Détermination de l'origine de l'acide tartrique L(+): naturelle ou fossile par la détermination de son activité C¹⁴ - Document OIV FV 1238, 2006

COMPENDIUM OF INTERNATIONAL METHODS OF ANALYSIS-OIV
Determination of total ethanol in wine
by high-performance liquid chromatography

Method OIV-MA-A313-24

Type IV method

Determination of total ethanol in wine
by high-performance liquid chromatography
(Resolution OIV-OENO 595-2018)

SCOPE OF APPLICATION

The method described is suitable for the determination of total (free and sulphur-dioxide-bound) ethanal in wine for concentrations between 0.2 and 80 mg/L.

1. PRINCIPLE

The analyte is quantified after derivatisation of the molecule with 2,4-Dinitrophenylhydrazine (DNPH) followed by elution using HPLC. Detection is based on the retention time at the wavelength of 365 nm.

2. REAGENTS AND PRODUCTS

- 2.1. 2,4-Dinitrophenylhydrazine (DNPH), CAS no. 119-26-6, purity $\geq 99.0\%$ (HPLC)
- 2.2. Sulphur dioxide (SO₂), as K₂S₂O₅, CAS no. 16731-55-8, purity $\geq 98\%$
- 2.3. Sulphuric acid (H₂SO₄), CAS no. 7664-93-9, purity 95.0-98.0%
- 2.4. Formic acid (CH₂O₂), CAS no. 64-18-6, purity $\approx 98\%$
- 2.5. Acetonitrile (C₂H₃N), CAS no. 75-05-8, purity $\geq 99.9\%$
- 2.6. Ethanal (CH₃CHO), CAS no. 75-07-0, purity $\geq 99.5\%$
- 2.7. Ultra-pure, HPLC-grade type I water compliant with standards ASTM D1193 and ISO 3696, CAS no. 7732-18-5
- 2.8. Perchloric acid (HClO₄), CAS no. 7601-90-3, purity 70 %

COMPENDIUM OF INTERNATIONAL METHODS OF ANALYSIS-OIV
Determination of total ethanol in wine
by high-performance liquid chromatography

Preparation of reagent solutions

- 2.9. Freshly-prepared sulphur dioxide solution at a concentration of 1120 mg/L SO₂, obtained by preparing a 2 g/L solution of K₂S₂O₅ (2.2) with ultra-pure, HPLC-grade water
- 2.10. 25% v/v sulphuric acid solution prepared by dilution of concentrated sulphuric acid (2.3) with ultra-pure, HPLC-grade water
- 2.11. 2.8% acetonitrile solution acidified with perchloric acid, obtained through the dilution of perchloric acid (2.8) in acetonitrile (2.5)
- 2.12. Freshly-prepared solution of 2,4-dinitrophenylhydrazine (2.1) in acidified acetonitrile (2.11) at a concentration of 2 g/L DNPH
- 2.13. Preparation of calibration solutions

The stock solution is prepared by dilution of an appropriate quantity of ethanal (density = 0.785 g/mL) in ultra-pure, HPLC-grade water in order to obtain a concentration of between 300 and 400 mg/L. Given that pure ethanal is highly volatile, the stock solution should be prepared by sampling constant volumes of ethanal using calibrated flasks (3.1). To prepare the stock solution, measure 10 mL pure ethanal in a calibrated flask, transfer the pure ethanal to another 20-mL calibrated flask and make up to the mark with ultra-pure, HPLC-grade water. The solutions diluted are prepared by making up to volume with ultra-pure, HPLC-grade water in calibrated flasks of greater capacity. Calibration solutions, with concentrations of 10 mg/L, 30 mg/L, 50 mg/L, 70 mg/L and 100 mg/L, are obtained through dilution of the stock solution in 50-mL calibrated flasks. The volumes required are sampled from the stock solution using a precision micropipette (3.2), for example, and made up to volume with ultra-pure, HPLC-grade water in calibrated flasks (3.1).

Preparation of solvent A for HPLC analysis

- 2.14. 0.5% (v/v) formic acid solution obtained by diluting concentrated formic acid (2.4) in ultra-pure, HPLC-grade water (2.7).

3. APPARATUS

COMPENDIUM OF INTERNATIONAL METHODS OF ANALYSIS-OIV
Determination of total ethanol in wine
by high-performance liquid chromatography

- 3.1. Everyday laboratory glassware, including class-A calibrated flasks of 10, 20 and 50 mL, 2-mL vials and 1-L containers for the solvents, and Pasteur pipettes
- 3.2. Precision micropipettes
- 3.3. Vortex-type stirrer
- 3.4. 0.45- μm membrane filters for sample preparation, certified for use in HPLC
- 3.5. 1-L vacuum flask (where the automatic degasser of the solvents is not provided with the HPLC apparatus)
- 3.6. Vacuum pump (where the automatic degasser of the solvents is not provided with the HPLC apparatus)
- 3.7. Analytical balance with precision of ± 0.0001 g
- 3.8. Natural convection oven with precision of ± 1 °C at 65 °C
- 3.9. HPLC apparatus with UV detector, equipped with two gradient pumps and an oven for the heating of the column
- 3.10. C18 column (250 x 4.6 mm, particle diameter: 4 μm)

Note: Any other system may be used on the condition that the ethanal is well separated from the other derivatised carbonyl compounds. The chromatographic resolution between the ethanal peak and the greatest neighbouring peak on the chromatogram should be higher than 1.

4. SAMPLING

The wine sample should be taken and stored in a glass container sealed with a Teflon stopper in an inert atmosphere (nitrogen or argon).

5. PROCEDURE

Derivatisation

The derivatisation takes place in 2-mL glass vials sealed with Teflon stoppers, inside which the following is successively added: 100 μL wine or standard solution filtered at 0.45 μm , 20 μL freshly-prepared sulphur dioxide solution (2.2) at a concentration of 1120 mg/L SO_2 , 20 μL 25% sulphuric acid (2.3) and 140 μL freshly-prepared solution of 2,4-dinitrophenylhydrazine in acetonitrile at a concentration of 2 g/L DNPH (2.12).

After these additions, the solution is immediately vortex stirred and placed in the oven at 65 °C for 15 minutes before being cooled at room temperature.

COMPENDIUM OF INTERNATIONAL METHODS OF ANALYSIS-OIV
Determination of total ethanol in wine
by high-performance liquid chromatography

Once the reaction is completed, the solution is cooled at room temperature for 15 minutes before being injected into the HPLC apparatus. The samples should be injected in less than 10 hours from the end of the derivatisation reaction.

HPLC analysis

The specific HPLC-analysis parameters are provided below by way of example.

Normal operating conditions:

- Injection volume: 15 µL
- Flow rate: 0.75 mL/min
- C18 column (5.10)
- Solvent for cleaning the injector: acetonitrile
- Column temperature: 35 °C
- Mobile-phase-A solvent: 0.5% formic acid in ultra-pure, HPLC-grade water
- Mobile-phase-B solvent: acetonitrile
- Detection at 365 nm

Elution gradient

The elution programme provides for:

35% eluent B (0.1 s)	65% eluent A (0,1 s)
60% eluent B (8 min)	40% eluent A (8 min)
90% eluent B (13 min)	10% eluent A (13 min)
95% eluent B (15 min)	5% eluent A (15 min)
95% eluent B (17 min)	5% eluent A (17 min)
35% eluent B (21 min)	65% eluent A (21 min)
35% eluent B (25 min)	65% eluent A (25 min)

COMPENDIUM OF INTERNATIONAL METHODS OF ANALYSIS-OIV
Determination of total ethanol in wine
by high-performance liquid chromatography

Example chromatogram

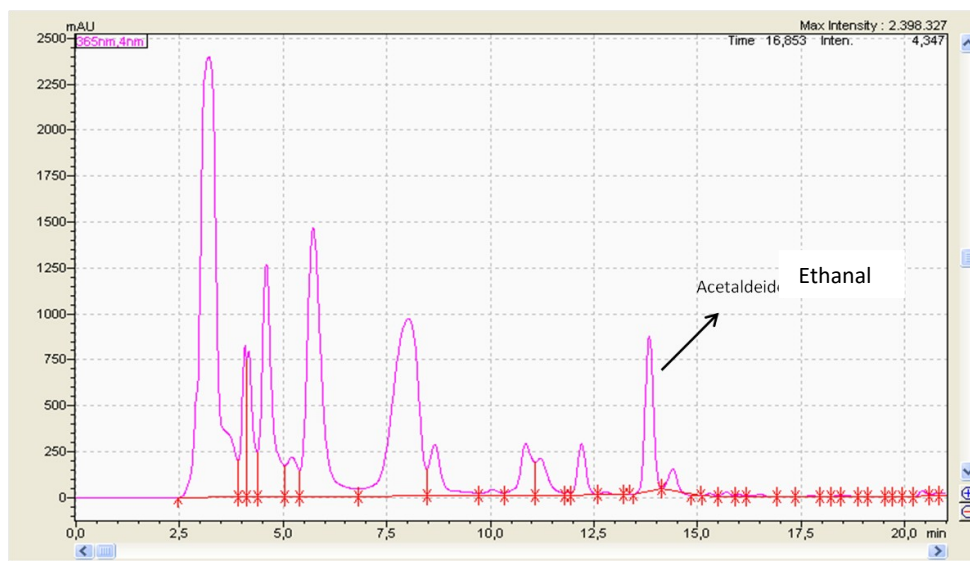

6. CALCULATION

The ethanol concentration is calculated based on the equation of the calibration curve obtained after injection of the calibration solutions (2.13).

7. PRECISION AND VALIDATION PARAMETERS

The coefficient of variation for the analyses repeated within the same laboratory should be less than 6% (for a concentration interval of between 10 mg/L and 100 mg/L). The repeatability standard deviation is 2.7% for a concentration of 14 mg/L, 2.98% for a concentration of 18 mg/L, 4.8% for a concentration of 22 mg/L and 1.3% for a concentration of 60 mg/L. The linearity range is between 0.2 and 80.0 mg/L. The limit of detection is 0.1 mg/L. The recovery rate in wine is between 92% and 102% (m/m).

8. RESULTS

The results are expressed in mg total ethanol / L to 1 decimal point.

9. BIBLIOGRAPHY

COMPENDIUM OF INTERNATIONAL METHODS OF ANALYSIS-OIV
Determination of total ethanol in wine
by high-performance liquid chromatography

Behforouz, M., Bolan, J. L., and Flynt, M. S., '2, 4-Dinitrophenylhydrazones: a modified method for the preparation of these derivatives and an explanation of previous conflicting results', *The Journal of Organic Chemistry*, 50 (8), 1985, pp. 1186-1189.

Elias, R. J., Laurie, V. F., Ebeler, S. E., Wong, J. W., and Waterhouse, A. L., 'Analysis of selected carbonyl oxidation products in wine by liquid chromatography with diode array detection', *Analytica chimica acta*, 626 (1), 2008, pp. 104-110.

Han, G., Wang, H., Webb, M. R., and Waterhouse, A. L., 'A rapid, one step preparation for measuring selected free plus SO₂-bound wine carbonyls by HPLC-DAD/MS', *Talanta*, 134, 2015, pp. 596-602.

COMPENDIUM OF INTERNATIONAL METHODS OF ANALYSIS-OIV
Determination of L-Lactic acid in wines
by automated enzymatic method

Method OIV-MA-A313-25

Type III method

Determination of L-Lactic acid in wines
by automated enzymatic method
(Resolution OIV-OENO 599-2018)

1. Scope of application

This method makes it possible to determine L-lactic acid in wine by specific enzyme analysis using an automatic sequential analyser.

In this document a collaborative study is reported which demonstrates application of the method for measurement of L-lactic acid in the range from 0.06 to 1.43 g/L.

Note: Where necessary each laboratory using this method may refine, and potentially widen, this range through a validation study.

2. Standard references

- OIV *Compendium of International Methods of Analysis: Lactic acid – enzymatic method*, OIV-MA-AS313-07,
- ISO 78-2: Chemistry – Layouts for standards.

3. Reaction principles

In the presence of nicotinamide adenine dinucleotide (NAD), L-lactic acid is oxidised to pyruvate in a reaction catalysed by L-lactate dehydrogenase (L-LDH). Since the equilibrium reaction is in favour of the lactate, it is necessary to remove the pyruvate formed which is converted into L-alanine in the presence of L-glutamate. This reaction is catalysed by glutamate pyruvate transaminase (GPT).

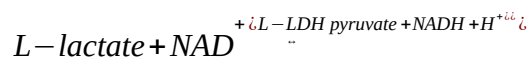

COMPENDIUM OF INTERNATIONAL METHODS OF ANALYSIS-OIV
Determination of L-Lactic acid in wines
by automated enzymatic method

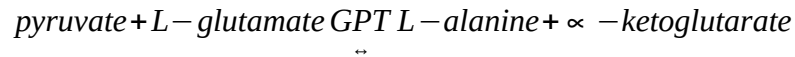

The reduced nicotinamide adenine dinucleotide (NADH) produced is measured based on its absorption at 340 nm. It is proportional to the quantity of L-lactic acid.

4. Reagents and working solutions

During the analysis – unless stated otherwise – only use reagents of recognised analytical grade and water that is distilled, demineralised or of equivalent purity.

4.1. Reagents

- 4.1.1. Quality I or II water for analytical usage (ISO 3696 standard)
- 4.1.2. Glycylglycine (CAS no. 556-50-3)
- 4.1.3. Glutamic acid (CAS no. 56-86-0)
- 4.1.4. NAD (nicotinamide adenine dinucleotide) (CAS no. 53-84-9)
- 4.1.5. L-LDH (L-lactate dehydrogenase) (CAS no. 9001-60-9)
- 4.1.6. GPT (glutamate pyruvate transaminase) (CAS no. 9000-86-6)
- 4.1.7. L-lactic acid of purity $\geq 98\%$ (CAS no. 79-33-4)
- 4.1.8. Polyvinylpyrrolidone (PVP) (CAS no. 9003-39-8)
- 4.1.9. Sodium hydroxide (CAS no. 1310-73-2)

Note 1: There are commercial kits for the determination of L-lactic acid. The user needs to check the composition to ensure it contains the above-indicated reagents.

Note 2: The use of PVP is recommended to eliminate any possible negative effect of tannins in wine on the enzyme's activity. Should the use of PVP not prove effective, the laboratory should ensure that the wine tannins do not interfere with the enzymes.

COMPENDIUM OF INTERNATIONAL METHODS OF ANALYSIS-OIV
Determination of L-Lactic acid in wines
by automated enzymatic method

4.2. Working solutions

4.2.1. A pH 10 buffer (0.60 M glycylglycine, 0.1 M L-glutamic acid).

The preparation may be as follows:

- glycylglycine (4.1.2): 4.75 g,
- glutamic acid (4.1.3): 0.88 g,
- PVP (4.1.8): 1 g,
- water for analytical usage (4.1.1): 50 mL.

The mixture is adjusted to pH 10 using a 10 M sodium hydroxide solution, then made up to 60 mL with water for analytical usage. This solution is stable for at least 4 weeks at 2-8 °C (approx.).

4.2.2. R1 working solution (example):

- water for analytical usage (4.1.1): 12 mL,
- NAD (4.1.4): 420 mg.

This solution is stable for at least 4 weeks at 2-8 °C (approx.).

4.2.3. R2 working solution (example):

- water for analytical usage (4.1.1): 1.2 mL,
- L-LDH (4.1.5): 7600 U,
- GPT (4.1.6): 2200 U.

This solution is stable for at least 4 weeks at 2-8 °C (approx.).

4.3. Calibration solutions

To ensure the closest possible connection to the International System of Units (SI), the calibration range should be created using pure solutions of L-lactic acid prepared by weighing and covering the measurement range.

5. Apparatus

5.1. Analyser

5.1.1. Equipment type

Automatic sequential analyser equipped with a spectrophotometer with a UV detector. The reaction temperature should be tightly controlled (generally 37 °C). The reaction cuvettes are glass, methacrylate or quartz. The equipment is

COMPENDIUM OF INTERNATIONAL METHODS OF ANALYSIS-OIV
Determination of L-Lactic acid in wines
by automated enzymatic method

controlled by software ensuring its operation, data acquisition and useful calculations.

5.1.2. Absorbance reading

The concentration of the analytes directly relates to the absorbance difference read by the spectrophotometer. The precision of the absorbance reading should be a minimum of 0.1 absorbance unit (AU). It is preferable not to use absorbance values higher than 2.0.

5.1.3. Precision of volumes collected

The precision of the volumes of reagents and samples collected by the pipettes of the analyser influences the measurement result. Quality control of the results using appropriate strategies (e.g. according to the guides published by the OIV) is recommended.

5.1.4. Reaction duration and temperature

In general, the reaction time is 10 minutes and the temperature is 37 °C. Certain pieces of apparatus may use slightly different values.

5.1.5. Wavelength

The wavelength of maximum absorption of the NADH formed by the reaction is 340 nm.

5.2. Balance

This should be calibrated to the International System of Units and have 1 mg precision.

5.3. pH meter

5.4. Measuring glassware

The measuring glassware for the preparation of reagents and calibration solutions is class A.

COMPENDIUM OF INTERNATIONAL METHODS OF ANALYSIS-OIV
Determination of L-Lactic acid in wines
by automated enzymatic method

6. Sampling

6.1. Preparation of samples of musts and still wines

In most cases, wine and must samples may be analysed without preparation. In some cases, a preparation may be introduced:

- Filtration or centrifugation should be used for highly turbid samples.
- Sample dilution (manual or automatic) with water for analytical usage should be used for values exceeding the measurement range.

6.2. Preparation of samples of sparkling wine containing CO₂

Sparkling wine samples containing CO₂ may produce bubbling effects. They must be degassed beforehand by stirring under vacuum, ultrasonic processing or any method enabling the required degassing.

7. Procedure

Given that different analysers may be used, it is recommended that the conditions of use provided by the manufacturer be strictly observed. This also applies to the various enzymatic kits available on the market.

The procedure takes place as follows:

1. The sample (S) is placed in a reaction cuvette.
2. Working solution R1 (4.2.2) is then added to the cuvette.
3. The two are mixed together. Time is then allowed for a lag period, in order to guarantee absorbance stability. This lag period may last from 1-5 min, and is defined by the laboratory, according to the characteristics of the equipment used.
4. Working solution R2 (4.2.3) is added and the reaction takes place.

By way of example, the quantities of different elements may be as follows:

- sample: 2.5 µL,
- buffer (80%) and R1 (20%): 120 µL,
- R2: 15 µL.

The equipment takes regular measurements that make it possible to obtain a reaction curve, an example of which is given in Figure 1.

COMPENDIUM OF INTERNATIONAL METHODS OF ANALYSIS-OIV
Determination of L-Lactic acid in wines
by automated enzymatic method

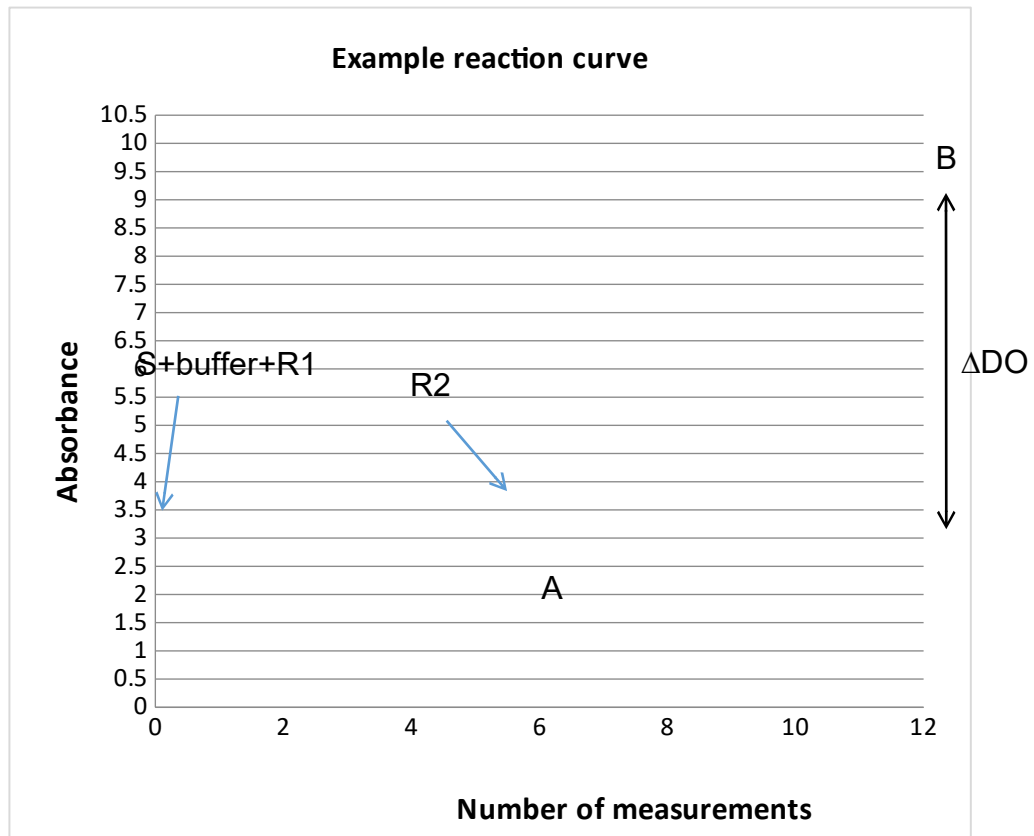

Figure 1: Reaction curve

The equipment makes it possible to choose the reading points for the difference in absorbance sought, for example A and B in Figure 1.

8. Calculation of results

The measurement used for the determination of the result is as follows:

$$\Delta DO = i(\text{Absorbance } B - \text{Absorbance } A)$$

In order to correlate this ΔDO value with the desired concentration of L-lactic acid, regular calibration of the apparatus is carried out using the calibration solutions at a minimum of 3 points covering the measurement range used. In the example given in Figure 2, the calibration curve is a straight line for values between 0 to 1.22 g/L L-lactic acid. In this case, for higher values, it is preferably to carry out a dilution.

COMPENDIUM OF INTERNATIONAL METHODS OF ANALYSIS-OIV
Determination of L-Lactic acid in wines
by automated enzymatic method

In addition, a reagent blank is used comprising all of the reagents but no sample (point 0 of the calibration).

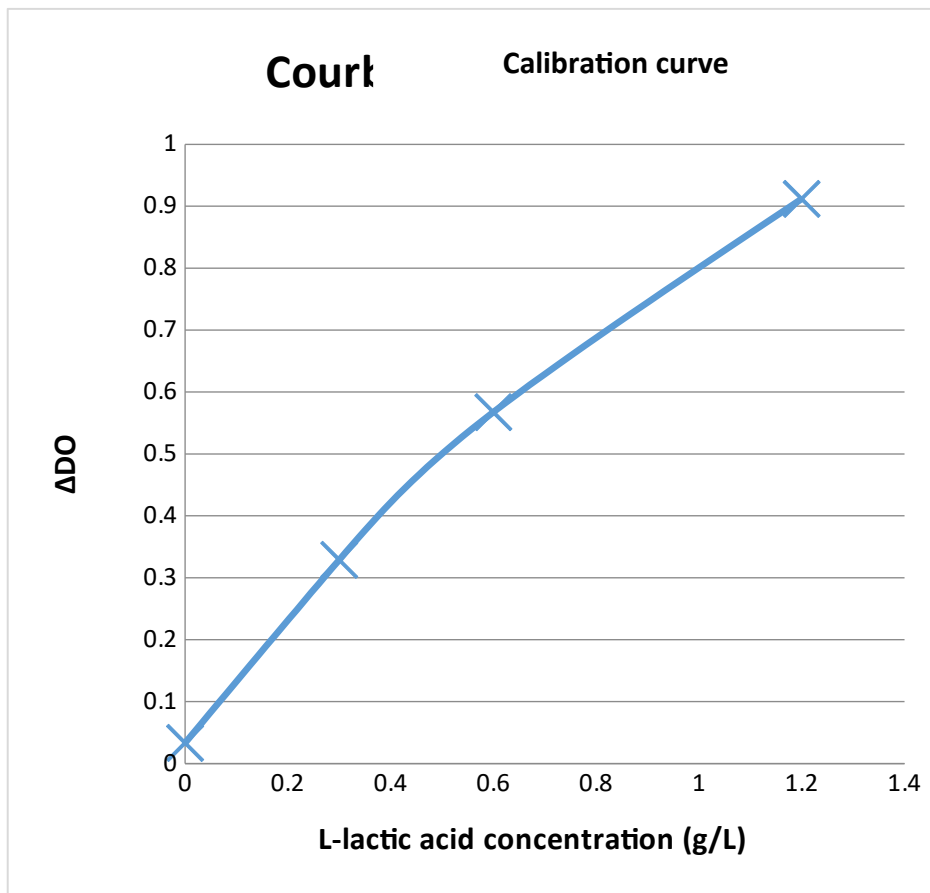

Figure 2: Calibration curve

The calibration curve can be order 1 ($Concentration = a.\Delta DO + b$), yet in this method it is more generally order 2 ($Concentration = a.\Delta DO^2 + b.\Delta DO + c$). If using a calibration curve of order 2, the laboratory should take care to limit the calibration domain in order to maintain sufficient sensitivity of the method (risk of crushing the curve with high concentrations).

The final value obtained should be multiplied by any coefficient of dilution used.

COMPENDIUM OF INTERNATIONAL METHODS OF ANALYSIS-OIV
Determination of L-Lactic acid in wines
by automated enzymatic method

9. Expression of results

The results are expressed in g/L of L-lactic acid to 2 d.p.

10. Precision

Interlaboratory reproducibility

$RSD_R = 7\%$ (from 0.5 g/L)

$CV_R\% (k=2) = 2 \cdot RSD_R = 14\%$, (from 0.5 g/L)

Repeatability

$RSD_r = 2\%$ (from 0.5 g/L)

$CV_r\% (k=2) = 2 \cdot RSD_r = 4\%$ (from 0.5 g/L)

Limit of quantification

Validated LOQ = 0.06 g/L

(Concentration where $CV_R\% (k=2) = 60\%$)

COMPENDIUM OF INTERNATIONAL METHODS OF ANALYSIS-OIV
Determination of L-Lactic acid in wines
by automated enzymatic method

ANNEX
Results of the interlaboratory tests

Collaborative study

A total of 16 laboratories from different countries participated in the collaborative study organised in 2016.

Labo	Country
Miguel Torres S.A.- Finca Mas La Plana	SPAIN
Estación Enológica de Castilla y León	SPAIN
INGACAL -Consellería do Medio Rural Estación de Viticultura e Enoloxía de Galicia	SPAIN
Estación Enológica de Haro	SPAIN
Comissão de Viticultura da Região dos Vinhos Verdes	PORTUGAL
Laboratoires Dubernet	FRANCE
Laboratoire Dicenos Rhône	FRANCE
Laboratoire Natoli	FRANCE
SCL Montpellier	FRANCE
Agricultural institute of Slovenia	SLOVENIA
Fachbereich: Wein, Weinüberwachung - Chemisches und Veterinäruntersuchungsamt Karlsruhe	GERMANY
HBLaUBA Wein - und Obstbau	AUSTRIA
Landesuntersuchungsamt Mainz	GERMANY
Hochschule GEISENHEIM University Institut Weinanalytik und Getränkforschung	GERMANY
Unità Chimica Vitenologica e Agroalimentare - Centro Trasferimento Tecnologico - Fondazione Edmund Mach	ITALY
Unione Italiana Vini soc. Coop.	ITALY

For analysis, 2 x 10 blind duplicate samples were used, with 1 repetition. The wines analysed are wines originating from France and Portugal, dry wines and liqueur wine

COMPENDIUM OF INTERNATIONAL METHODS OF ANALYSIS-OIV
Determination of L-Lactic acid in wines
by automated enzymatic method

Sample		A		B		C		D		E		F		G		H		I		J	
		(liqueur wine)		(dry wine)		(dry wine)		(dry wine)		(dry wine)		(dry wine)		(dry wine)		(sweetened wine)		(sweetened wine)		(sweetened wine)	
Position		1	9	2	13	3	4	5	15	6	10	16	20	7	11	12	17	8	19	14	18
Labo3	rep#1	0.17	0.14	0.04	0.04	0.49	0.49	0.68	0.73	1.03	1.06	<i>1.03</i>	<i>1.09</i>	1.34	1.31			0.12	0.12	1.36	1.34
	rep#2	0.18	0.17	0.01	0.02	0.43	0.50	0.68	0.68	1.01	1.04	<i>1.05</i>	<i>1.07</i>	1.28	1.26			0.12	0.11	1.24	1.32
Labo6	rep#1	0.19	0.19			0.55	0.55	0.77	0.73	1.15	1.11	<i>1.09</i>	<i>1.09</i>	1.42	1.39	0.04	0.03	0.14	0.13	1.47	1.43
	rep#2	0.14	0.14			0.52	0.52	0.75	0.71	1.16	1.11	<i>1.09</i>	<i>1.10</i>	1.44	1.41	0.03	0.03	0.08	0.07	1.50	1.45
Labo7	rep#1	0.16	0.17	0.04	0.04	0.51	0.52	0.72	0.73	1.09	1.05	<i>1.01</i>	<i>1.07</i>	1.33	1.36	0.03	0.03	0.12	0.13	1.42	1.42
	rep#2	0.17	0.17	0.03	0.04	0.50	0.50	0.72	0.72	1.05	1.09	<i>1.04</i>	<i>1.08</i>	1.34	1.32	0.02	0.03	0.12	0.12	1.44	1.43
Labo9	rep#1	0.15	0.14			0.50	0.54	0.70	0.70	1.09	1.10	<i>1.06</i>	<i>1.06</i>	1.31	1.27			0.11	0.07	1.41	1.43
	rep#2	0.14	0.15			0.50	0.52	0.69	0.74	1.10	1.08	<i>1.01</i>	<i>1.01</i>	1.29	1.27	0.01		0.10	0.12	1.37	1.33
Labo12	rep#1	0.17	0.18	0.08	0.08	0.51	0.51	0.74	0.75	1.06	1.04	<i>1.04</i>	<i>1.02</i>	1.34	1.34			0.16	0.16	1.40	1.40
	rep#2	0.17	0.18	0.08	0.08	0.51	0.51	0.74	0.76	1.04	1.00	<i>1.03</i>	<i>1.00</i>	1.34	1.36			0.17	0.18	1.40	1.42
Labo13	rep#1	0.16	0.16	0.05	0.05	0.49	0.48	0.71	0.72	1.00	1.08	<i>1.01</i>	<i>1.01</i>	1.30	1.42	0.03	0.03	0.12	0.12	1.39	1.41
	rep#2	0.16	0.17	0.05	0.05	0.49	0.50	0.71	0.73	1.03	1.05	<i>1.01</i>	<i>1.05</i>	1.29	1.33	0.02	0.02	0.13	0.12	1.37	1.37
Labo14	rep#1	0.15	0.14	0.02	0.02	0.61	0.61	0.79	0.79	1.20	1.21	<i>1.23</i>	<i>1.24</i>	1.53	1.49	0.01	0.01	0.10	0.10	1.59	1.58
	rep#2	0.14	0.14	0.02	0.02	0.60	0.61	0.79	0.79	1.22	1.21	<i>1.24</i>	<i>1.24</i>	1.53	1.52	0.01	0.01	0.10	0.10	1.59	1.59
Labo15	rep#1	0.40	0.43	0.09	0.08	1.00	0.98	1.03	1.07	1.69	1.68	<i>1.60</i>	<i>1.60</i>	2.04	2.10	0.06	0.07	0.24	0.19	2.07	2.06
	rep#2	0.43	0.36	0.03	0.03	0.95	0.99	1.05	1.09	1.64	1.68	<i>1.62</i>	<i>1.63</i>	2.04	2.03	0.04	0.01	0.16	0.19	2.17	2.01
Labo16	rep#1	0.17	0.17	0.03	0.03	0.53	0.53	0.73	0.75	1.14	1.12	<i>1.08</i>	<i>1.09</i>	1.37	1.38	0.03	0.02	0.12	0.13	1.50	1.44

COMPENDIUM OF INTERNATIONAL METHODS OF ANALYSIS-OIV
Determination of L-Lactic acid in wines
by automated enzymatic method

	rep#2	0.17 0.17	0.03 0.05	0.55 0.53	0.74 0.74	1.15 1.13	<i>1.06 1.08</i>	1.40 1.37	0.04 0.02	0.12 0.12	1.46 1.45
Labo17	rep#1	0.12 0.13	0.02 0.02	0.46 0.45	0.65 0.71	1.01 1.01	<i>1.03 1.07</i>	1.20 1.18	0.01 0.01	0.10 0.09	1.36 1.36
	rep#2	0.12 0.13	0.03 0.03	0.46 0.48	0.69 0.70	1.05 1.07	<i>1.04 1.03</i>	1.29 1.32	0.01 0.01	0.08 0.10	1.37 1.37
Labo18	rep#1	0.16 0.15	0.04 0.04	0.44 0.43	0.64 0.63	0.95 0.95	0.92 0.92	1.19 1.17	0.03 0.03	0.11 0.11	1.23 1.25
	rep#2	0.14 0.15	0.04 0.04	0.44 0.45	0.63 0.63	0.94 0.95	0.92 0.91	1.18 1.17	0.03 0.03	0.11 0.11	1.26 1.26
Labo19	rep#1	0.16 0.16	0.04 0.04	0.55 0.58	0.79 0.80	1.18 1.21	1.12 1.14	1.42 1.45	0.02 0.02	0.13 0.13	1.49 1.50
	rep#2	0.16 0.16	0.04 0.04	0.56 0.56	0.78 0.74	1.13 1.15	1.13 1.14	1.43 1.46	0.03 0.02	0.13 0.13	1.51 1.51
Labo20	rep#1	0.17 0.18	0.04 0.04	0.53 0.53	0.74 0.75	1.11 1.09	<i>1.06 1.07</i>	1.30 1.32	0.03 0.03	0.13 0.13	1.39 1.42
	rep#2	0.17 0.18	0.04 0.04	0.53 0.53	0.74 0.75	1.11 1.09	<i>1.06 1.07</i>	1.30 1.32	0.03 0.03	0.13 0.13	1.39 1.42
Labo21	rep#1	0.18 0.18	0.05 0.05	0.56 0.56	0.79 0.80	1.17 1.22	<i>1.19 1.20</i>	1.46 1.50	0.05 0.05	0.13 0.13	1.54 1.58
	rep#2	0.17 0.18	0.05 0.05	0.56 0.56	0.79 0.81	1.19 1.21	<i>1.20 1.23</i>	1.47 1.48	0.05 0.05	0.13 0.13	1.55 1.57
Labo22	rep#1	0.24 0.23	0.05 0.06	0.53 0.51	0.70 0.72	1.04 1.10	<i>1.01 1.00</i>	1.29 1.28	0.05 0.04	0.13 0.16	1.38 1.40
	rep#2	0.24 0.22	0.05 0.05	0.52 0.52	0.70 0.74	1.04 1.06	<i>1.06 1.03</i>	1.29 1.29	0.05 0.04	0.15 0.14	1.43 1.41

Table of the data obtained. The values in bold correspond with the values rejected in accordance with the Cochran (variance outliers) test with a 2.5% significance level (one-tailed test), and the Grubbs (outliers from the mean) test with significance levels of 2.5% (two-tailed test).

COMPENDIUM OF INTERNATIONAL METHODS OF ANALYSIS-OIV
Determination of L-Lactic acid in wines
by automated enzymatic method

Note: The absent values have not been provided by the laboratory in question.

Sample	A	B	C	D	E	F	G	H	I	J
No. of laboratories selected	12	12	13	14	14	14	12	12	12	12
No. of repetitions	4	4	4	4	4	4	4	4	4	4
Min.	0.13	0.02	0.44	0.63	0.95	0.92	1.18	0.01	0.09	1.25
Max.	0.18	0.08	0.61	0.80	1.21	1.24	1.52	0.05	0.17	1.59
Overall average	0.16	0.04	0.52	0.73	1.09	1.07	1.36	0.03	0.12	1.43
Repeatability variance	0.00005	0.00003	0.00011	0.00028	0.00053	0.00035	0.00032	0.00002	0.00004	0.00028
Inter-labo stand. dev.	0.02	0.02	0.04	0.04	0.07	0.08	0.10	0.01	0.02	0.09
Reproducibility variance	0.0003	0.0003	0.0020	0.0021	0.0057	0.0067	0.0093	0.0002	0.0004	0.0083
Repeatability standard dev.	0.01	0.01	0.01	0.02	0.02	0.02	0.02	0.00	0.01	0.02
r limit	0.02	0.02	0.03	0.05	0.06	0.05	0.05	0.01	0.02	0.05
Repeatability RSD _r	4.3%	14.1%	2.0%	2.3%	2.1%	1.8%	1.3%	16.9%	5.0%	1.2%
Reproducibility stand. dev.	0.02	0.02	0.04	0.05	0.08	0.08	0.10	0.01	0.02	0.09
R limit	0.05	0.05	0.13	0.13	0.21	0.23	0.27	0.04	0.06	0.26

COMPENDIUM OF INTERNATIONAL METHODS OF ANALYSIS-OIV
Determination of L-Lactic acid in wines
by automated enzymatic method

Reproducibility RSD _R	10.5%	40.0%	8.5%	6.4%	7.0%	7.6%	7.1%	50.8%	16.5%	6.4%
Horwitz RSD _r	4.92	6.03	4.12	3.92	3.69	3.70	3.57	6.46	5.11	3.54
Horrat _r	0.87	2.33	0.49	0.59	0.57	0.48	0.37	2.62	0.98	0.33
Horwitz RSD _R	7.46	9.13	6.24	5.93	5.58	5.60	5.40	9.79	7.74	5.36
Horrat _R	1.41	4.38	1.36	1.07	1.25	1.36	1.32	5.19	2.13	1.19

Table of the results obtained

Note: The results from samples B and H should be taken with caution due to the very low concentration levels, which are below the laboratories' limit of quantification.

COMPENDIUM OF INTERNATIONAL METHODS OF ANALYSIS-OIV
Determination of L-Lactic acid in wines
by automated enzymatic method

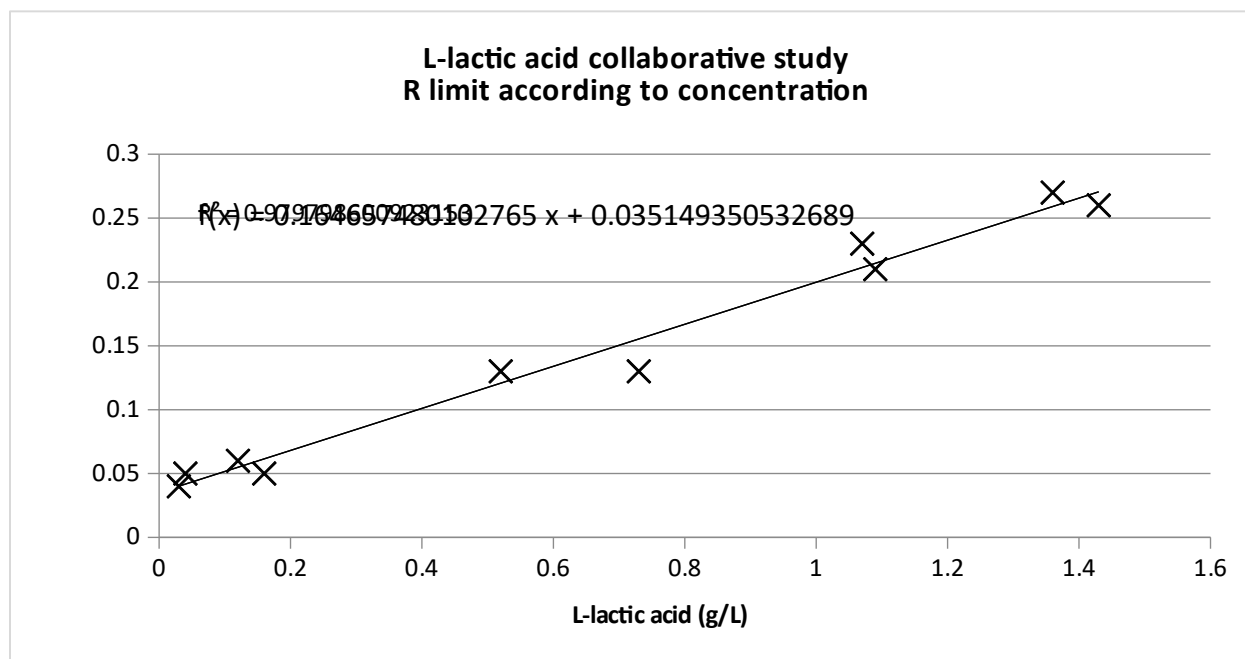

Figure 3: R limit according to concentration

COMPENDIUM OF INTERNATIONAL METHODS OF ANALYSIS-OIV
Determination of L-Lactic acid in wines
by automated enzymatic method

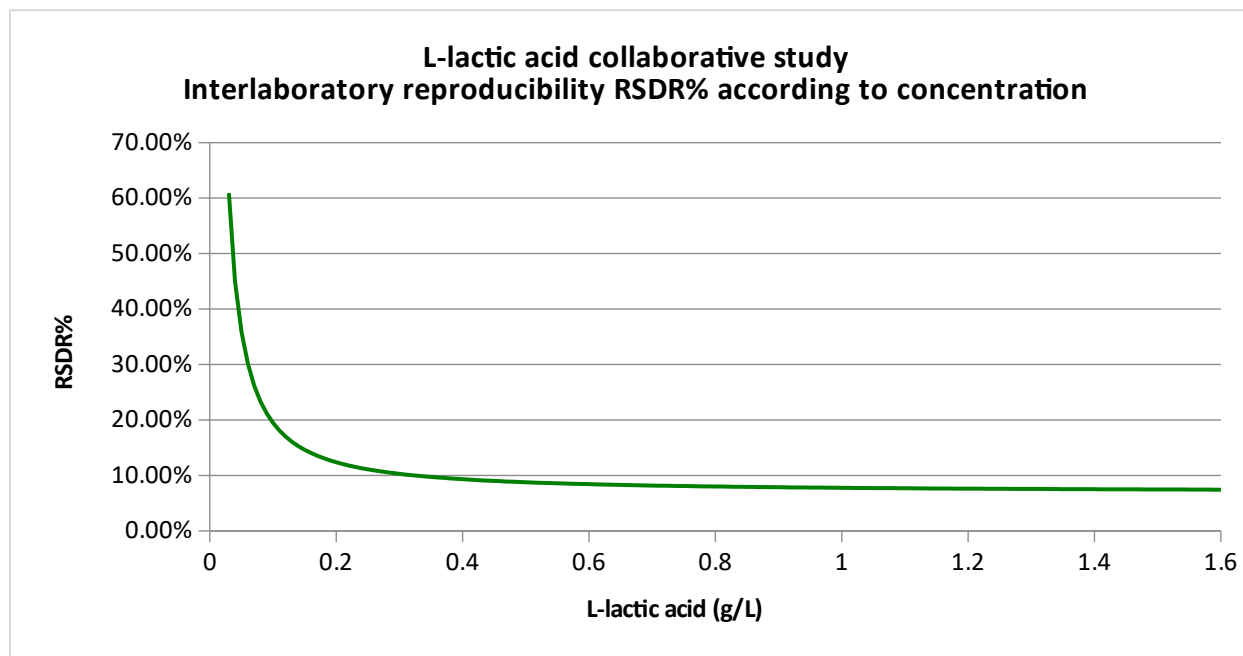

Figure 4: Interlaboratory RSD_R% according to concentration.
Modelling: $RSD_R\% = 0.758 \cdot C^{(-1.216)} + 7$

COMPENDIUM OF INTERNATIONAL METHODS OF ANALYSIS-OIV
Determination of L-malic acid in wine
by automated enzymatic method

Method OIV-MA-A313-26

Type III method

**Determination of L-malic acid in wine by automated
enzymatic method**

(Resolution OIV-OENO 599-2018)

1. Scope of application

This method makes it possible to determine L-malic acid in wine by specific enzyme analysis using an automatic sequential analyser.

In this document, a collaborative study is reported which demonstrates application of the method for measurement of L-malic acid in the range from 0.12 to 2.3 g/L.

Note: Where necessary, each laboratory using this method may refine, and potentially widen, this range through a validation study.

2. Standard references

- OIV *Compendium of International Methods of Analysis*: L-malic acid – enzymatic method, OIV-MA-AS313-11,
- ISO 78-2: Chemistry – Layouts for standards.

3. Reaction principles

In the presence of nicotinamide adenine dinucleotide (NAD), L-malic acid is oxidised to oxaloacetate in a reaction catalysed by L-malate dehydrogenase (L-MDH). Since the equilibrium reaction is in favour of the malate, it is necessary to remove the oxaloacetate formed which is converted into L-aspartate in the presence of L-glutamate. This reaction is catalysed by glutamate oxaloacetate transaminase (GOT).

COMPENDIUM OF INTERNATIONAL METHODS OF ANALYSIS-OIV
Determination of L-malic acid in wine
by automated enzymatic method

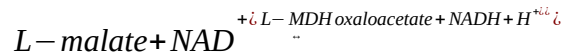

The reduced nicotinamide adenine dinucleotide (NADH) produced is measured based on its absorption at 340 nm. It is proportional to the quantity of L-malic acid.

4. Reagents and working solutions

During the analysis – unless stated otherwise – only use reagents of recognised analytical grade and water that is distilled, demineralised or of equivalent purity.

4.1. Reagents

- 4.1.1. Quality I or II water for analytical usage (ISO 3696 standard);
- 4.1.2. Glycylglycine (CAS no. 556-50-3);
- 4.1.3. Glutamic acid (CAS no. 56-86-0);
- 4.1.4. NAD (nicotinamide adenine dinucleotide) (CAS no. 53-84-9);
- 4.1.5. L-MDH (L-malate dehydrogenase) (CAS no. 9001-64-3);
- 4.1.6. GOT (glutamate oxaloacetate transaminase) (CAS no. 9000-97-9);
- 4.1.7. L-malic acid, purity $\geq 95\%$ (CAS no. 97-67-6);
- 4.1.8. Optional: polyvinylpyrrolidone (PVP) (CAS no. 9003-39-8) or potentially PVPP (CAS no. 25249-54-1);
- 4.1.9. Sodium hydroxide (CAS no. 1310-73-2).

Note 1: There are commercial kits for the determination of L-malic acid. The user needs to check the composition to ensure it contains the above-indicated reagents.

COMPENDIUM OF INTERNATIONAL METHODS OF ANALYSIS-OIV
Determination of L-malic acid in wine
by automated enzymatic method

Note 2: The use of PVP is recommended to eliminate any possible negative effect of tannins in wine on the enzyme protein molecules. Should the use of PVP not prove effective, the laboratory should ensure that the wine tannins do not interfere with the enzymes.

4.2. Working solutions

4.2.1. A pH 10 buffer (0.60 M glycylglycine, 0.1 M L-glutamic acid).

The preparation may be as follows:

- glycylglycine (4.1.2): 4.75 g,
- glutamic acid (4.1.3): 0.88 g,
- PVP (4.1.8): 1 g,
- water for analytical usage (4.1.1): 50 mL.

The mixture is adjusted to pH 10 using a 10 M sodium hydroxide solution, then made up to 60 mL with water for analytical usage. This solution is stable for at least 4 weeks at 2-8 °C (approx.).

4.2.2. R1 working solution (example):

- water for analytical usage (4.1.1): 12 mL,
- NAD (4.1.4): 420 mg.

This solution is stable for at least 4 weeks at 2-8 °C (approx.).

4.2.3. R2 working solution (example):

- water for analytical usage (4.1.1): 1.2 mL,
- L-MDH (4.1.5): 4800 U,
- GOT (4.1.6): 320 U.

This solution is stable for at least 4 weeks at 2-8 °C (approx.).

4.3. Calibration solutions

To ensure the closest possible connection to the International System of Units (SI), the calibration range should be created using pure solutions of L-malic acid prepared by weighing and covering the measurement range.

5. Apparatus

5.1. Analyser

5.1.1. Equipment type

COMPENDIUM OF INTERNATIONAL METHODS OF ANALYSIS-OIV
Determination of L-malic acid in wine
by automated enzymatic method

Automatic sequential analyser equipped with a spectrophotometer with a UV detector. The reaction temperature should be tightly controlled (generally 37 °C). The reaction cuvettes are glass, methacrylate or quartz. The equipment is controlled by software ensuring its operation, data acquisition and useful calculations.

5.1.2. Absorbance reading

The concentration of the analytes directly relates to the absorbance difference read by the spectrophotometer. The precision of the absorbance reading should be a minimum of 0.1 absorbance unit (AU). It is preferable not to use absorbance values higher than 2.0.

5.1.3. Precision of volumes collected

The precision of the volumes of reagents and samples collected by the pipettes of the analyser influences the measurement result. Quality control of the results using appropriate strategies (e.g. according to the guides published by the OIV) is recommended.

5.1.4. Reaction duration and temperature

In general, the reaction time is 10 minutes and the temperature is 37 °C. Certain pieces of apparatus may use slightly different values.

5.1.5. Use of a reagent blank

The results are read by comparing the light intensity absorbed at the chosen wavelength between a cuvette in which the reaction is carried out and a cuvette in which the reaction does not take place (blank reagent).

5.1.6. Wavelength

The wavelength of maximum absorption of the NADH formed by the reaction is 340 nm.

5.2. Balance

This should be calibrated to the International System of Units and have 1 mg precision.

COMPENDIUM OF INTERNATIONAL METHODS OF ANALYSIS-OIV
Determination of L-malic acid in wine
by automated enzymatic method

5.3. pH meter

5.4. Measuring glassware

The measuring glassware for the preparation of reagents and calibration solutions is class A.

6. Sampling

6.1. Preparation of samples of musts and still wines

In most cases, wine and must samples may be analysed without preparation. In some cases, a preparation may be introduced:

- filtration or centrifugation should be used for highly turbid samples,
- sample dilution (manual or automatic) with water for analytical usage should be used for values exceeding the measurement range.

6.2. Preparation of samples of sparkling wine containing CO₂

Sparkling wine samples containing CO₂ may produce bubbling effects. They must be degassed beforehand by stirring under vacuum, ultrasonic processing or any method enabling the required degassing.

7. Procedure

Given that different analysers may be used, it is recommended that the conditions of use provided by the manufacturer be strictly observed. This also applies to the various enzymatic kits available on the market.

The procedure takes place as follows:

1. The sample (S) is placed in a reaction cuvette.
2. Working solution R1 (4.2.2) is then added to the cuvette.
3. The two are mixed together. Time is then allowed for a lag period, in order to guarantee absorbance stability. This lag period may last from 1-5 min, and is defined by the laboratory, according to the characteristics of the equipment used.
4. Working solution R2 (4.2.3) is added and the reaction takes place.

COMPENDIUM OF INTERNATIONAL METHODS OF ANALYSIS-OIV
Determination of L-malic acid in wine
by automated enzymatic method

By way of example, the quantities of different elements may be as follows:

- sample: 2.5 μL ,
- mixture of 80% buffer (3.2.1) and 20% R1 (3.2.2): 120 μL ,
- R2 (3.2.3): 15 μL .

The equipment takes regular measurements that make it possible to obtain a reaction curve, an example of which is given in Figure 1.

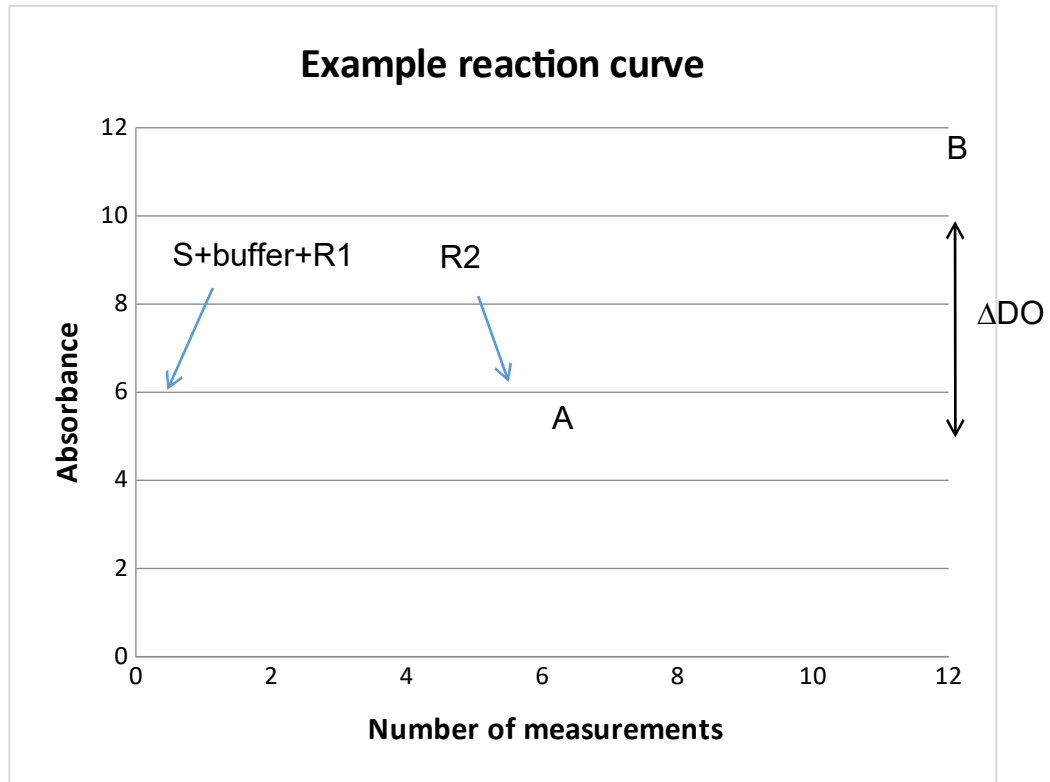

Figure 1: Reaction curve

The equipment makes it possible to choose the reading points for the difference in absorbance sought, for example A and B in Figure 1.

COMPENDIUM OF INTERNATIONAL METHODS OF ANALYSIS-OIV
Determination of L-malic acid in wine
by automated enzymatic method

8. Calculation of results

The measurement used for the determination of the result is as follows:

$$\Delta DO = \epsilon (\text{Absorbance } B - \text{Absorbance } A)$$

In order to correlate this ΔDO value with the desired concentration of L-malic acid, regular calibration of the apparatus is carried out using the calibration solutions (§4.3) at a minimum of 3 points covering the measurement range. In the example given in Figure 2, the calibration curve obtained is a straight line for values between 0 and 2 g/L L-malic acid. In this case, for higher values, it is preferable to dilute the sample. In addition, a reagent blank is used comprising all of the reagents but no sample (point 0 of the calibration).

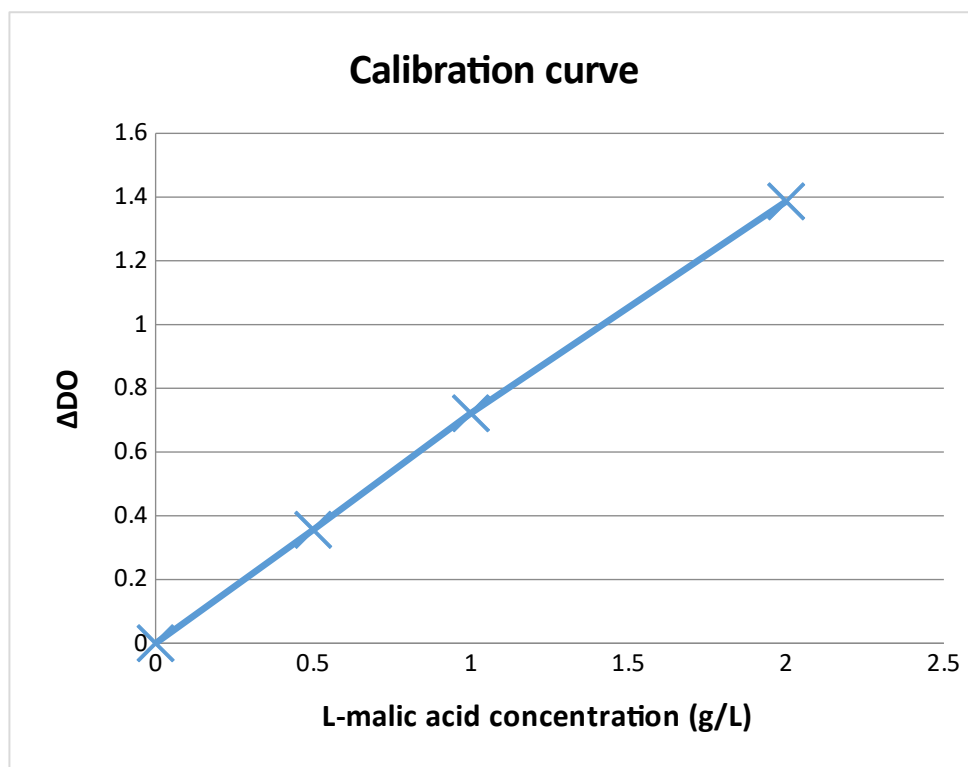

Figure 2: Calibration curve

The calibration curve can be order 1 ($Concentration = a.\Delta DO + b$) or even order 2 ($Concentration = a.\Delta DO + b.\Delta DO + c$). If using a calibration curve of order 2, the

COMPENDIUM OF INTERNATIONAL METHODS OF ANALYSIS-OIV
Determination of L-malic acid in wine
by automated enzymatic method

laboratory should take care to limit the calibration domain in order to maintain sufficient sensitivity of the method (risk of crushing the curve with high concentrations).

The final value obtained should be multiplied by any coefficient of dilution used.

9. Expression of results

The results are expressed in g/L L-malic acid to 2 d.p.

10. Precision

Interlaboratory reproducibility

$RSD_R = 5\%$ (from 1 g/L)

$CV_R\% (k=2) = 2 \cdot RSD_R = 10\%$, (from 1 g/L)

Repeatability

$RSD_r = 2\%$ (from 1 g/L)

$CV_r\% (k=2) = 2 \cdot RSD_r = 4\%$ (from 1 g/L)

Limit of quantification

Validated LOQ = 0,12 g/L

(Concentration where $CV_R\% (k=2) = 60\%$)

COMPENDIUM OF INTERNATIONAL METHODS OF ANALYSIS-OIV
Determination of L-malic acid in wine
by automated enzymatic method

ANNEX

Results of the interlaboratory tests
Collaborative study

A total of 16 Laboratories from different countries participated in the collaborative study organised in 2016.

Labo	Country
Miguel Torres S.A.- Finca Mas La Plana	SPAIN
Estación Enológica de Castilla y León	SPAIN
INGACAL -Consellería do Medio Rural Estación de Viticultura e Enoloxía de Galicia	SPAIN
Estación Enológica de Haro	SPAIN
Comissão de Viticultura da Região dos Vinhos Verdes	PORTUGAL
Laboratoires Dubernet	FRANCE
Laboratoire Diconos Rhône	FRANCE
Laboratoire Natoli	FRANCE
SCL Montpellier	FRANCE
Agricultural institute of Slovenia	SLOVENIA
Fachbereich: Wein, Weinüberwachung - Chemisches und Veterinäruntersuchungsamt Karlsruhe	GERMANY
HBLAuBA Wein - und Obstbau	AUSTRIA
Landesuntersuchungsamt Mainz	GERMANY
Hochschule GEISENHEIM University Institut Weinanalytik und Getränkforschung	GERMANY
Unità Chimica Vitienologica e Agroalimentare - Centro Trasferimento Tecnologico - Fondazione Edmund Mach	ITALY
Unione Italiana Vini soc. Coop.	ITALY

For analysis, 2 x 10 blind duplicate samples were used, with 1 repetition. The wines analysed are wines originating from France and Portugal, dry wines and liqueur wines.

COMPENDIUM OF INTERNATIONAL METHODS OF ANALYSIS-OIV
Determination of L-malic acid in wine
by automated enzymatic method

Sample		A		B		C		D		E		F		G		H		I		J	
Position		1	9	2	13	3	4	5	15	6	10	16	20	7	11	12	17	8	19	14	18
Labo3	rep#1	1.12	1.09	2.16	2.21	0.08	0.08	1.38	1.39	0.16	0.16	<i>0.05</i>	<i>0.04</i>	0.07	0.06	1.31	1.35	1.24	1.27	0.07	0.07
	rep#2	1.15	1.11	2.18	2.11	0.08	0.09	1.35	1.41	0.16	0.16	<i>0.05</i>	<i>0.04</i>	0.06	0.06	1.32	1.30	1.23	1.24	0.07	0.07
Labo6	rep#1	0.99	0.95	2.28	2.31	0.04	0.02	1.44	1.47	0.05	0.08	<i>0.04</i>	<i>0.04</i>	0.06	0.04	1.38	1.46	1.34	1.19	0.04	0.03
	rep#2	0.93	0.93	2.15	2.16	0.05	0.03	1.23	1.37	0.08	0.09	<i>0.03</i>	<i>0.05</i>	0.03	0.04	1.28	1.30	1.20	1.28	0.03	0.03
Labo7	rep#1	1.10	1.10	2.28	2.33	0.01		1.44	1.52	0.12	0.10		<i>0.01</i>			1.38	1.41	1.33	1.30	0.01	0.02
	rep#2	1.13	1.13	2.35	2.33	0.03	0.04	1.47	1.49	0.14	0.13				0.02	1.40	1.43	1.32	1.33	0.02	0.03
Labo9	rep#1	1.14	1.10	2.27	2.21	0.06	0.10	1.43	1.48	0.19	0.19	<i>0.02</i>	<i>0.02</i>	0.05	0.06	1.35	1.38	1.27	1.28	0.05	0.08
	rep#2	1.15	1.20	2.20	2.23	0.10	0.06	1.50	1.51	0.15	0.14	<i>0.03</i>	<i>0.01</i>	0.09	0.11	1.31	1.37	1.22	1.28	0.04	0.06
Labo12	rep#1	1.12	1.12	2.34	2.32	0.06	0.02	1.47	1.54	0.14	0.14	<i>0.04</i>	<i>0.03</i>	0.03	0.03	1.37	1.37	1.29	1.31	0.06	0.04
	rep#2	1.12	1.12	2.38	2.34	0.07	0.01	1.46	1.46	0.16	0.19	<i>0.04</i>	<i>0.05</i>	0.03	0.04	1.32	1.33	1.28	1.30	0.06	0.04
Labo13	rep#1	1.11	1.09	2.12	2.26	0.04	0.02	1.44	1.45	0.12	0.14	<i>0.01</i>	<i>0.01</i>	0.03	0.03	1.45	1.33	1.29	1.29	0.02	0.02
	rep#2	1.18	1.17	2.20	2.29	0.03	0.01	1.47	1.50	0.11	0.12			0.02	0.03	1.39	1.38	1.32	1.33		0.01
Labo14	rep#1	1.32	1.30	2.66	2.68			1.69	1.67	0.08	0.08					1.65	1.60	1.51	1.52		

OIV-MA-AS313-26 : R2018

COMPENDIUM OF INTERNATIONAL METHODS OF ANALYSIS-OIV
Determination of L-malic acid in wine
by automated enzymatic method

	rep#2	1.30	1.30	2.63	2.68			1.67	1.67	0.08	0.08			1.61	1.60	1.51	1.53				
Labo15	rep#1	1.18	1.19	2.29	2.42	0.06	0.05	1.41	1.50	0.16	0.16	<i>0.04</i>	<i>0.04</i>	0.08	0.08	1.33	1.39	1.26	1.30	0.07	0.07
	rep#2	1.13	1.20	2.21	2.42	0.05	0.05	1.49	1.52	0.16	0.16	<i>0.04</i>	<i>0.04</i>	0.08	0.08	1.38	1.39	1.27	1.28	0.07	0.07
Labo16	rep#1	1.22	1.22	2.52	2.48			1.63	1.62	0.09	0.09			1.50	1.53	1.47	1.45				
	rep#2	1.21	1.20	2.45	2.55			1.62	1.61	0.09	0.09	<i>0.03</i>		1.52	1.51	1.44	1.45				
Labo17	rep#1	1.14	1.14	2.22	2.22	0.07	0.08	1.51	1.50	0.17	0.17	<i>0.07</i>	<i>0.07</i>	0.11	0.11	1.34	1.35	1.28	1.27	0.09	0.09
	rep#2	1.13	1.15	2.17	2.20	0.08	0.08	1.46	1.47	0.18	0.17	<i>0.08</i>	<i>0.07</i>	0.12	0.12	1.31	1.34	1.28	1.29	0.09	0.09
Labo18	rep#1	1.10	1.11	2.14	2.13	0.18	0.18	1.42	1.52	0.28	0.28	0.16	0.16	0.19	0.19	1.33	1.38	1.27	1.31	0.17	0.18
	rep#2	1.10	1.13	2.19	2.16	0.18	0.18	1.44	1.51	0.27	0.27	0.16	0.16	0.19	0.19	1.33	1.38	1.29	1.33	0.17	0.18
Labo19	rep#1	1.13	1.19	2.20	2.23	0.08	0.08	1.47	1.44	0.17	0.19	0.07	0.08	0.11	0.11	1.36	1.30	1.27	1.26	0.10	0.10
	rep#2	1.15	1.22	2.21	2.23	0.08	0.09	1.48	1.45	0.18	0.19	0.07	0.08	0.12	0.11	1.33	1.30	1.28	1.24	0.09	0.10
Labo20	rep#1	1.17	1.20	2.27	2.27	0.04	0.05	1.50	1.48	0.17	0.17	<i>0.04</i>	<i>0.03</i>	0.07	0.07	1.33	1.34	1.28	1.29	0.07	0.06
	rep#2	1.17	1.20	2.27	2.27	0.04	0.05	1.50	1.48	0.17	0.17	<i>0.04</i>	<i>0.03</i>	0.07	0.07	1.34	1.34	1.28	1.29	0.07	0.06
Labo21	rep#1	1.10	1.12	2.30	2.47	0.05	0.05	1.45	1.49	0.11	0.10	<i>0.05</i>	<i>0.05</i>	0.05	0.05	1.46	1.44	1.33	1.41	0.05	0.05
	rep#2	1.09	1.16	2.28	2.50	0.05	0.05	1.49	1.51	0.09	0.11	<i>0.05</i>	<i>0.05</i>	0.05	0.05	1.43	1.46	1.34	1.37	0.05	0.05
Labo22	rep#1	1.08	1.07	2.35	2.31	0.04	0.03	1.46	1.45	0.11	0.12	<i>0.01</i>	<i>0.02</i>	0.03	0.03	1.35	1.35	1.26	1.31	0.03	0.02
	rep#2	1.06	1.08	2.30	2.31	0.04	0.04	1.51	1.46	0.12	0.12	<i>0.01</i>	<i>0.03</i>	0.04	0.03	1.35	1.34	1.28	1.25	0.01	0.01

Table of the data obtained. The values in bold correspond with the values rejected in accordance with the Cochran

COMPENDIUM OF INTERNATIONAL METHODS OF ANALYSIS-OIV
Determination of L-malic acid in wine
by automated enzymatic method

(variance outliers) test with a 2.5% significance level (one-tailed test), and the Grubbs (outliers from the mean) test with significance levels of 2.5% (two-tailed test).

Note: The absent values have not been provided by the laboratory in question.

Sample	A	B	C	D	E	F	G	H	I	J
No. of laboratories selected	15	15	12	14	13	13	12	12	12	12
No of repetitions	4	4	4	4	4	4	4	4	4	4
Min.	0.95	2.15	0.03	1.38	0.08	0.01	0.02	1.32	1.25	0.02
Max.	1.31	2.66	0.08	1.68	0.28	0.08	0.19	1.45	1.36	0.10
Overall average	1.14	2.30	0.05	1.49	0.14	0.04	0.07	1.36	1.29	0.05
Repeatability variance	0.001	0.003	0.000	0.001	0.000	0.000	0.000	0.001	0.000	0.000
Inter-laboratory stand. dev.	0.08	0.14	0.02	0.07	0.05	0.02	0.05	0.04	0.03	0.03
Reproducibility variance	0.006	0.021	0.001	0.006	0.003	0.000	0.002	0.002	0.001	0.001
Repeatability stand. dev.	0.03	0.05	0.01	0.03	0.01	0.01	0.01	0.03	0.02	0.01
r limit	0.07	0.15	0.04	0.08	0.02	0.02	0.01	0.07	0.06	0.02
Repeatability RSD _r	2.2%	2.4%	25.0%	2.0%	6.2%	15.4%	7.4%	1.9%	1.6%	14.5%
Reproducibility stand. dev.	0.08	0.14	0.02	0.08	0.05	0.02	0.05	0.04	0.04	0.03

COMPENDIUM OF INTERNATIONAL METHODS OF ANALYSIS-OIV
Determination of L-malic acid in wine
by automated enzymatic method

R limit	0.22	0.41	0.07	0.21	0.16	0.06	0.14	0.12	0.10	0.08
Reproducibility RSD _R	6.9%	6.2%	46.9%	5.0%	39.1%	57.5%	71.2%	3.2%	2.8%	53.1%
Horwitz RSD _r	3.66	3.29	5.81	3.51	5.02	6.13	5.57	3.56	3.59	5.81
Horrat _r	0.61	0.72	4.30	0.57	1.24	2.52	1.33	0.53	0.45	2.49
Horwitz RSD _R	5.55	4.99	8.80	5.32	7.60	9.29	8.44	5.40	5.44	8.81
Horrat _R	1.25	1.25	5.33	0.95	5.14	6.19	8.43	0.59	0.51	6.02

Table of the results obtained

Note: The results from samples C, F, G and J should be taken with caution due to the very low concentration levels, which are below the laboratories' limit of quantification.

COMPENDIUM OF INTERNATIONAL METHODS OF ANALYSIS-OIV
Determination of L-malic acid in wine
by automated enzymatic method

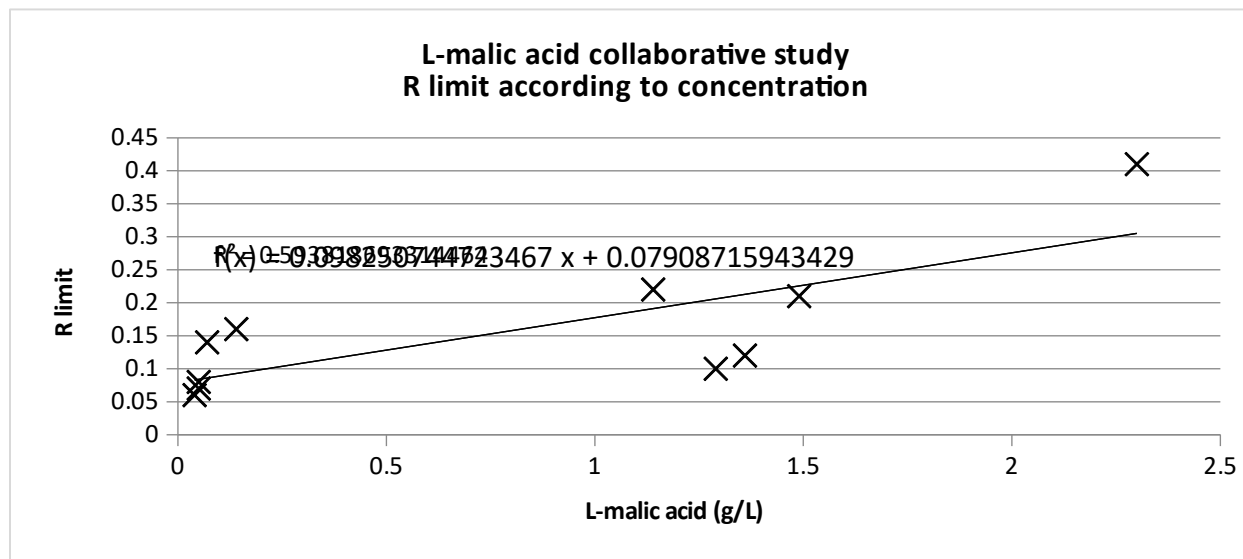

Figure 3: R limit according to concentration

COMPENDIUM OF INTERNATIONAL METHODS OF ANALYSIS-OIV
Determination of L-malic acid in wine
by automated enzymatic method

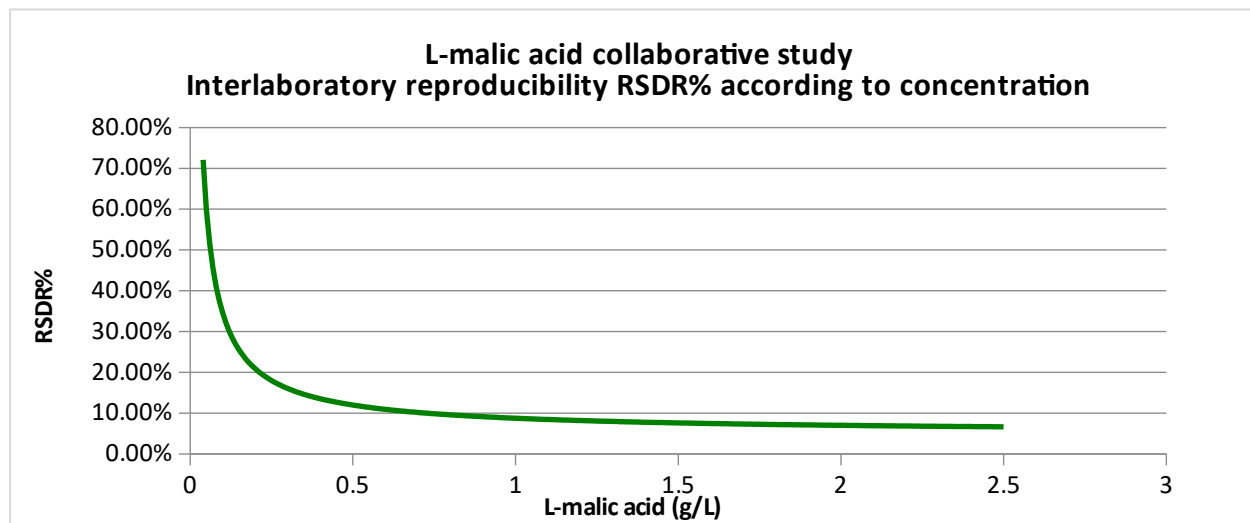

Figure 4: RSD_R% according to concentration
Modelling: $CV\% = 3.763 \cdot C^{(-0.895)} + 5$

**DETERMINATION OF ACETIC ACID IN WINES BY
AUTOMATED ENZYMATIC METHOD**

OIV-OENO 621-2019

1. *Scope of application*

This method makes it possible to determine acetic acid in wines using an automatic sequential analyser and specific enzyme analysis. The measurement range, which was the object of the current interlaboratory validation, is from 0.2 to 1.14 g/L acetic acid.

NOTE: A range of higher values may be analysed with the introduction of a sample dilution.

2. *Standard references*

- ISO 78-2: Chemistry – Layouts for standards

3. *Reaction principles*

In the presence of ATP, acetic acid is converted into acetyl phosphate in a reaction catalysed by acetate kinase.

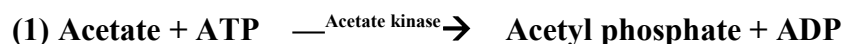

The ADP formed by this reaction is reconverted into ATP in a reaction with phosphoenolpyruvate catalysed by pyruvate kinase.

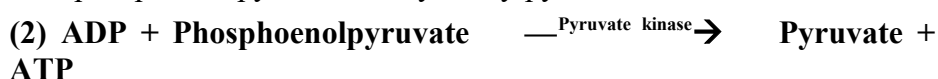

Pyruvate is reduced to L-lactate by reduced nicotinamide adenine dinucleotide (NADH) catalysed by lactate dehydrogenase.

COMPENDIUM OF INTERNATIONAL METHODS OF ANALYSIS-OIV
Determination of acetic acid in wines
by automated enzymatic method

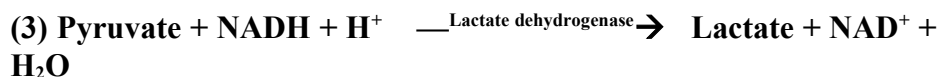

The quantity of oxidised NADH in reaction (3) is determined by the absorbance measurement at 340 nm, and is proportional to the concentration of acetic acid in the wine.

Note 1:

When this enzymatic analysis is conducted manually, the reading is carried out once the stabilised, final plateau is reached. To achieve this, a fourth reaction makes it possible to completely push the equilibrium of reaction 1 towards the formation of acetyl phosphate through elimination of the latter.

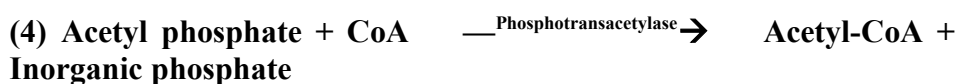

In the case of analysis by an automated method, which has a shorter analysis time, it is not necessary to reach a stabilised, final plateau, and this reaction is pointless. The use of phosphotransacetylase is therefore not necessary, and is not described here.

Note 2:

The enzymatic reaction chain involves pyruvate. The low quantities of pyruvate (several tens of mg/L) normally present in wines do not have a significant impact on the result. In the rare cases, the presence in wine of an untypical quantity of pyruvate is likely to produce a method bias.

4. *Reagents and working solutions*

During analysis – unless otherwise indicated – use only quality, recognised analytical reagents and distilled or demineralised water, or water of equivalent purity.

COMPENDIUM OF INTERNATIONAL METHODS OF ANALYSIS-OIV
Determination of acetic acid in wines
by automated enzymatic method

- 4.1. Reagents
 - 4.1.1. Quality I or II water for analytical use (ISO 3696 standard)
 - 4.1.2. 3-(N-Morpholino)propanesulfonic acid (MOPS): CAS no. 1132-61-2
 - 4.1.3. Magnesium chloride **hexahydrate**: CAS no. 7791-18-6
 - 4.1.4. Potassium chloride: CAS no. 7447-40-7
 - 4.1.5. β -Nicotinamide adenine dinucleotide (NADH): CAS no. 53-84-9, purity $\geq 98\%$
 - 4.1.6. Adenosine-5'-triphosphate, disodium salt (ATP): CAS no. 56-65-5
 - 4.1.7. Potassium hydroxide: CAS no. 1310-58-3
 - 4.1.8. Phosphoenolpyruvate tri(cyclohexylammonium) salt: CAS no. 35556-70-8 or monosodium phosphoenolpyruvate: CAS no. 138-08-9 (PEP)
 - 4.1.9. Acetate kinase (AK): CAS no. 9027-42-3
 - 4.1.10. Pyruvate kinase (PK): CAS no. 9001-59-6
 - 4.1.11. Lactate dehydrogenase (LDH): CAS no. 9001-60-9
 - 4.1.12. Polyvinylpyrrolidone (PVP): CAS no. 9003-39-8
 - 4.1.13. Acetic acid: purity $\geq 99.5\%$; CAS no. **64-19-7**
 - 4.1.14. Sodium chloride: CAS no. 7647-14-15
 - 4.1.15. Bovine serum albumin (BSA): CAS no. 9048-46-8

Note 3: There are commercial kits for the determination of acetic acid. The user needs to check the composition to ensure it contains the above-indicated reagents. These kits are sometimes supplied with phosphotransacetylase (redundant when using an automated method).

Note 4: The use of PVP is recommended to eliminate any possible negative action of tannins in wine on the enzyme protein molecules. In the event that the use of PVP is not effective, the laboratory should ensure the absence of interference of wine tannins on the enzymes.

COMPENDIUM OF INTERNATIONAL METHODS OF ANALYSIS-OIV
Determination of acetic acid in wines
by automated enzymatic method

Note 5: BSA is an agent used for the stabilisation of enzymes in solution.

4.2. Working solutions

4.2.1. MOPS buffer

The preparation may be as follows:

- 13 g MOPS (3-(N-Morpholino)propanesulfonic acid) (4.1.2),
- 0.5 g magnesium chloride hexahydrate (4.1.3),
- 1.5 g potassium chloride (KCl) (4.1.4),
- 1.3 g PVP (4.1.12),
- 250 mL water for analytical usage (4.1.1).

Adjust the pH to 4.75 with a 1.5 M potassium hydroxide (KOH) solution (4.1.7).

Wait 5 minutes and readjust the pH to 7.45 with a 1.5 M potassium hydroxide (KOH) solution (4.1.7).

Make up to 300 mL with water for analytical use (4.1.1).

The buffer can be kept for at least 60 days at 2-8 °C (approximately).

4.2.2. Working solution 1 (R1)

The preparation may be as follows:

- 100 mL MOPS buffer (4.2.1),
- 300-350 mg adenosine-5'-triphosphate, disodium salt (ATP) (4.1.6),
- 50 mg phosphoenolpyruvate (PEP) tri(cyclohexylammonium) salt (4.1.8),
- 40 mg β -nicotinamide adenine dinucleotide (reduced form) (NADH) (4.1.5).

Working solution R1 can be kept for at least 30 days at 2-8 °C (approximately).

4.2.3. Working solution 2 (R2)

The preparation may be as follows:

- 100 mL MOPS buffer (4.2.1),
- approx. 40 units of pyruvate kinase (PK) (4.1.10),
- approx. 40 units of lactate dehydrogenase (LDH) (4.1.11),
- 50 units of acetate kinase (AK) (4.1.9),
- 300 mg BSA (4.1.15).

Working solution R2 can be kept for approximately 48 hours at 2-8 °C (approximately).

Note: When preparing these solutions, they should be mixed gently to avoid the formation of foam. The life cycle of the working solutions is limited and should be evaluated and respected by the laboratory.

4.3. Calibration solutions

In order to ensure the closest possible connection to the International System of Units (SI), the calibration range should be made up of pure solutions of acetic acid (4.1.13). It is recommended to prepare a stock solution (e.g. 1.5 g.L⁻¹ acetic acid) by weight, then the rest of the calibrations are obtained from the stock solution to cover the measurement range.

A "zero" value may be obtained using a 9‰ sodium chloride solution (4.1.14) or equivalent saline solution.

5. *Apparatus*

5.1. Analyser

5.1.1. Equipment type

Automatic sequential analyser equipped with a spectrophotometer with UV detector. The reaction temperature should be stable (at around 37 °C). The reaction cuvettes are glass, methacrylate or quartz. The equipment is controlled by software that handles its operation, data acquisition and useful calculations.

COMPENDIUM OF INTERNATIONAL METHODS OF ANALYSIS-OIV
Determination of acetic acid in wines
by automated enzymatic method

5.1.2. Absorbance reading

The concentration of the analytes directly relates to the absorbance difference read by the spectrophotometer. The precision of the absorbance reading should be a minimum of 0.1 absorbance unit (AU). The absorbance values should not be saturating for the spectrometer used.

5.1.3. Precision of sampled volumes

The volumes of reagents and samples taken by the pipettes of the analyser should be of sufficient precision so as not to have a significant impact on the measurement result.

5.1.4. Reaction duration and temperature

In general, the reaction time is 10 minutes and the temperature 37 °C. Some pieces of apparatus may use slightly different values.

5.1.5. Use of a reagent blank

The results are read by comparing the light intensity absorbed at the chosen wavelength between a cuvette in which the reaction is carried out and a cuvette in which the reaction does not take place (reagent blank).

5.1.6. Wavelength

The wavelength of maximum absorption of the NADH formed by the reaction is 340 nm. For spectrophotometers in general use, this wavelength is to be selected.

A secondary wavelength is programmed in order to correct a potential matrix effect; this wavelength is 410 nm.

The measurement is conducted based on the $DO_{340} - DO_{410}$ absorbance difference.

5.2. Balance

This should be calibrated to the SI and have a 1 mg resolution.

5.3. pH meter

5.4. Measuring glassware

COMPENDIUM OF INTERNATIONAL METHODS OF ANALYSIS-OIV
Determination of acetic acid in wines
by automated enzymatic method

The measuring glassware for the preparation of reagents and calibration solutions is class A.

6. *Sample preparation*

6.1. Test samples

6.1.1. Preparation of samples of still wines

The majority of wine samples may be analysed without preparation. In some cases, a preparation may be introduced:

- Filtration should be used for highly turbid samples. Sample dilution (manual or automatic) with water for analytical usage (4.1.1) should be used for values higher than the measurement range.

6.1.2. Preparation of samples of sparkling wines

Sparkling wine samples should be subjected to a preliminary degassing by stirring under vacuum, ultrasonic treatment or any method that allows for the required degassing.

7. *Procedure*

Given that different analysers may be used, it is recommended that the conditions of use provided by the manufacturer are strictly respected. The same goes for different enzymatic kits that are available on the market. The procedure takes place as follows:

1. The sample (S) is placed in a reaction cuvette.
2. Working solution R1 (4.2.2) is then added to the cuvette.
3. Homogenisation takes place. Time is then allowed for a lag period, in order to guarantee absorbance stability. This lag period may last from 1 to 5 min, and is defined by the laboratory, according to the characteristics of the equipment used.
4. Working solution R2 (4.2.3) is added and the reaction is triggered.

By way of example, the quantities of the different elements may be as follows:

COMPENDIUM OF INTERNATIONAL METHODS OF ANALYSIS-OIV
Determination of acetic acid in wines
by automated enzymatic method

- sample: 3 μL ,
- R1: 120 μL , at T_0 (start of sequence),
- R2: 60 μL , at $T_0 + 3 \text{ min } 40 \text{ sec}$.

The equipment carries out regular measurements that make it possible to obtain a reaction curve, an example of which is given in Figure 1.

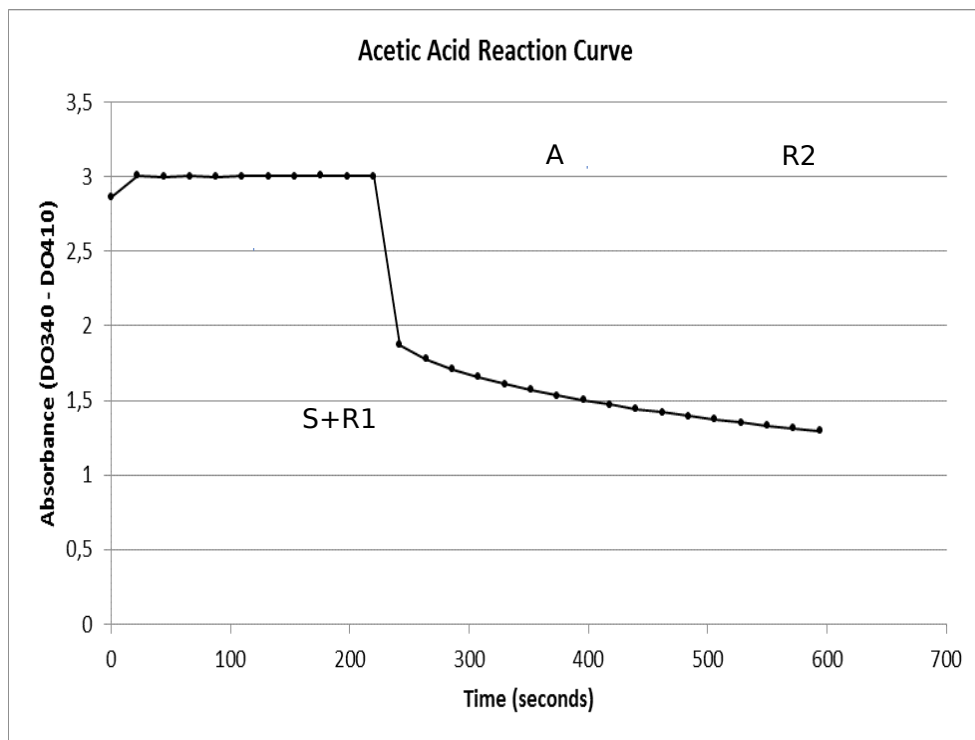

B

Figure 1. Reaction curve

The equipment makes it possible to choose the reading points for the difference in absorbance sought, for example A and B in Figure 1.

In order to correlate this value with the concentration of acetic acid, regular calibration of the apparatus is carried out using the calibration solutions at a minimum of 3 points covering the measurement range used. The calibration curve obtained is near to a straight line. Nevertheless, a second-degree equation may be used. An example is given in Figure 2.

COMPENDIUM OF INTERNATIONAL METHODS OF ANALYSIS-OIV
Determination of acetic acid in wines
by automated enzymatic method

In addition, a reagent blank is used comprising all of the reagents but no sample (point 0 of calibration).

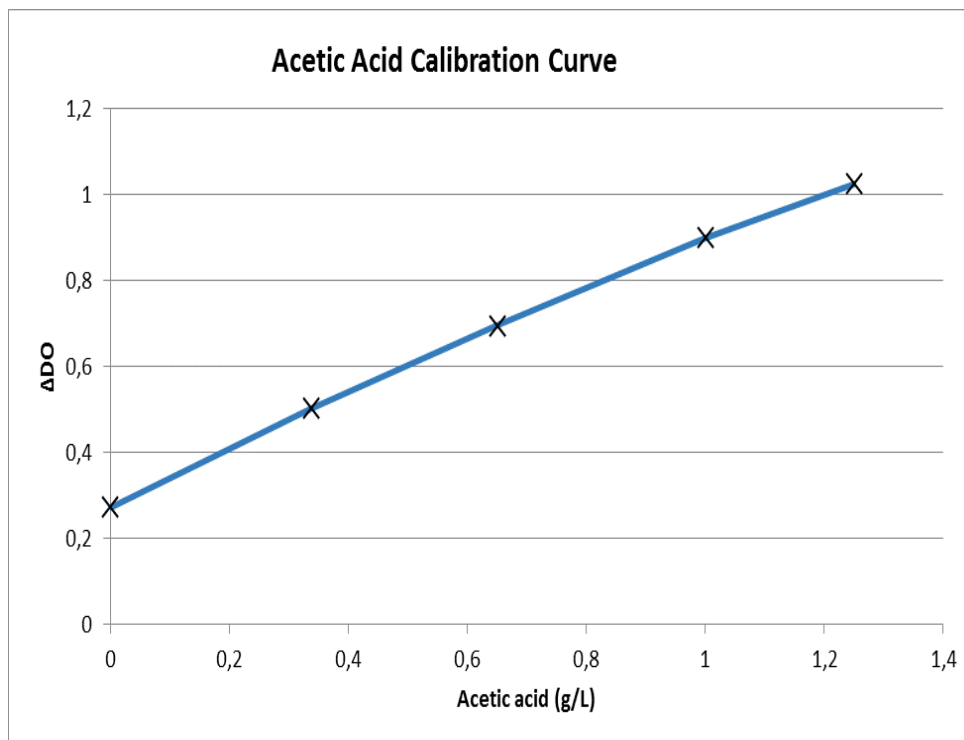

Figure 2. Calibration curve

8. Calculations

For each measurement, the result is given according to the following formula:

$$R = |Absorbance B - Absorbance A|$$

COMPENDIUM OF INTERNATIONAL METHODS OF ANALYSIS-OIV
Determination of acetic acid in wines
by automated enzymatic method

The values thus obtained are recorded on the calibration curve to obtain the acetic acid concentration. The final value obtained should be multiplied by any coefficient of dilution used.

9. *Expression of results*

The results for acetic acid are expressed in g/L of acetic acid, calculated to two decimal places, or in another unit according to usage (meq/L). The expression of the result should be consistent with the measurement uncertainty.

10. *Automated enzymatic method characteristics*

Interlaboratory reproducibility

$$\text{RSD}_R = 10\%$$
$$\text{CV}_R\% (k=2) = 2 \cdot \text{RSD}_R = 20\%$$

Repeatability

$$\text{RSD}_r = 4\%$$
$$\text{CV}_r\% (k=2) = 2 \cdot \text{RSD}_r = 8\%$$

Limit of quantification

Validated LQ < 0.2 g/L
Not determined in the collaborative study

11. *Bibliography*

- McCLOSKEY Leo P., 'An Improved enzymatic assay for acetate in juice and wine', *Am. J. Enol. Vitic.*, Vol. 31, No. 21980.

COMPENDIUM OF INTERNATIONAL METHODS OF ANALYSIS-OIV
Determination of acetic acid in wines
by automated enzymatic method

ANNEX

Method performance studies

Collaborative study

In total, 11 laboratories from 5 different countries took part in the collaborative study.

Laboratory	Country
Miguel Torres S.A.- Finca Mas La Plana	Spain
INGACAL -Consellería do Medio Rural Estación de Viticultura e Enoloxía de Galicia	Spain
Estación Enológica de Haro	Spain
Laboratoires Dubernet	France
Laboratoire Diœnos Rhône	France
Laboratoire Natoli	France
SCL Montpellier	France
Fachbereich: Wein, Weinüberwachung - Chemisches und Veterinäruntersuchungsamt Karlsruhe	Germany
HBLAuBA Wein - und Obstbau	Austria
Hochschule GEISENHEIM University Institut Weinanalytik und Getränkforschung	Germany
Unione Italiana Vini soc. Coop.	Italy

Table 1. Participating laboratories

In total, 2 x 10 samples prepared as blind duplicates were analysed, with 1 repetition. The wines analysed were dry wines, sweetened wines, and liqueur wines, wines originating from France and Portugal.

COMPENDIUM OF INTERNATIONAL METHODS OF ANALYSIS-OIV
Determination of acetic acid in wines
by automated enzymatic method

Sample		A		B		C		D		E		F		G		H		I		J	
		Port wine		Sweetened wine		Dry wine		Dry wine		Sweetened wine		Dry wine		Dry wine		Sweetened wine		Sweetened wine		Sweetened wine	
Position		1	9	2	13	3	4	5	15	6	10	16	20	7	11	12	17	8	19	14	18
Lab3	rep#1	0.24	0.27	0.20	0.21	0.65	0.65	0.47	0.49	0.54	0.52	1.28	1.30	0.64	0.63	0.29	0.31	0.39	0.37	0.63	0.62
	rep#2	0.25	0.26	0.20	0.21	0.67	0.65	0.46	0.50	0.56	0.53	1.29	1.33	0.65	0.67	0.29	0.28	0.36	0.37	0.65	0.61
Lab7	rep#1	0.20	0.20	0.22	0.23	0.62	0.62	0.45	0.46	0.50	0.50	1.25	1.30	0.61	0.62	0.28	0.28	0.34	0.35	0.62	0.60
	rep#2	0.20	0.21	0.21	0.22	0.63	0.64	0.45	0.46	0.53	0.52	1.20	1.20	0.61	0.64	0.29	0.28	0.35	0.37	0.60	0.61
Lab9	rep#1	0.17	0.18	0.18	0.19	0.57	0.52	0.40	0.40	0.41	0.43	1.18	1.18	0.57	0.54	0.24	0.29	0.36	0.32	0.53	0.51
	rep#2	0.17	0.19	0.16	0.17	0.59	0.57	0.39	0.43	0.44	0.41	1.16	1.14	0.55	0.55	0.25	0.29	0.30	0.33	0.55	0.51
Lab12	rep#1	0.17	0.18	0.20	0.20	0.56	0.53	0.40	0.41	0.44	0.44	1.02	1.01	0.53	0.53	0.27	0.28	0.36	0.33	0.49	0.51
	rep#2	0.17	0.18	0.20	0.21	0.55	0.54	0.40	0.41	0.44	0.44	1.02	1.01	0.52	0.52	0.28	0.29	0.36	0.34	0.48	0.51
Lab13	rep#1	0.22	0.19	0.23	0.20	0.50	0.51	0.40	0.40	0.42	0.44	0.95	0.97	0.48	0.49	0.27	0.28	0.32	0.32	0.48	0.50
	rep#2	0.20	0.19	0.23	0.21	0.52	0.52	0.39	0.39	0.43	0.42	0.97	0.96	0.51	0.48	0.28	0.28	0.32	0.33	0.50	0.51
Lab14	rep#1	0.17	0.17	0.20	0.19	0.56	0.57	0.42	0.41	0.46	0.45	1.10	1.14	0.55	0.54	0.27	0.26	0.34	0.32	0.53	0.51
	rep#2	0.17	0.17	0.20	0.19	0.56	0.57	0.42	0.41	0.45	0.44	1.12	1.10	0.53	0.55	0.26	0.26	0.33	0.31	0.53	0.53
Lab15	rep#1	0.22	0.23	0.28	0.27	0.68	0.68	0.52	0.52	0.56	0.56	1.20	1.23	0.69	0.73	0.35	0.34	0.47	0.42	0.60	0.62
	rep#2	0.22	0.22	0.26	0.26	0.68	0.63	0.53	0.50	0.52	0.54	1.18	1.13	0.65	0.67	0.34	0.34	0.42	0.41	0.59	0.64
Lab17	rep#1	0.20	0.19	0.26	0.25	0.54	0.52	0.41	0.42	0.39	0.39	1.01	1.00	0.49	0.45	0.32	0.29	0.34	0.35	0.44	0.43
	rep#2	0.20	0.20	0.27	0.27	0.53	0.55	0.43	0.43	0.43	0.43	1.03	1.05	0.49	0.49	0.31	0.32	0.37	0.38	0.44	0.46
Lab18	rep#1	0.27	0.25	0.35	0.33	0.69	0.68	0.53	0.56	0.59	0.59	1.24	1.21	0.66	0.68	0.43	0.41	0.50	0.51	0.65	0.63
	rep#2	0.28	0.27	0.36	0.36	0.68	0.69	0.55	0.57	0.60	0.60	1.26	1.23	0.68	0.71	0.44	0.43	0.50	0.52	0.63	0.65
Lab20	rep#1	0.23	0.20	0.29	0.29	0.58	0.57	0.49	0.47	0.47	0.47	1.15	1.13	0.55	0.58	0.34	0.35	0.39	0.40	0.55	0.52
	rep#2	0.23	0.20	0.29	0.29	0.58	0.57	0.49	0.47	0.47	0.47	1.15	1.13	0.55	0.58	0.34	0.36	0.39	0.40	0.55	0.52
Lab22	rep#1	0.17	0.16	0.20	0.18	0.60	0.60	0.43	0.44	0.47	0.47	1.20	1.20	0.58	0.58	0.26	0.26	0.32	0.32	0.55	0.58
	rep#2	0.17	0.17	0.19	0.19	0.61	0.61	0.43	0.43	0.48	0.47	1.21	1.22	0.59	0.58	0.26	0.27	0.31	0.33	0.54	0.59

Table 2. Table of data obtained (in g·L⁻¹ of acetic acid). The values in bold correspond to the values rejected by the Cochran (variance outliers) test with a 2.5% significance level (one-tailed test), and the Grubbs (outliers from the mean) test with a significance level of 2.5% (two-tailed test).

COMPENDIUM OF INTERNATIONAL METHODS OF ANALYSIS-OIV
Determination of acetic acid in wines
by automated enzymatic method

Sample	A	B	C	D	E	F	G	H	I	J
No. of laboratories selected	11	10	11	10	10	11	10	9	9	9
No. of repetitions	4	4	4	4	4	4	4	4	4	4
Min.	0.17	0.18	0.51	0.40	0.41	0.96	0.49	0.26	0.32	0.50
Max.	0.27	0.29	0.69	0.52	0.55	1.30	0.69	0.35	0.39	0.63
Overall average	0.20	0.22	0.59	0.44	0.47	1.14	0.59	0.30	0.35	0.55
Repeatability variance	0.000 1	0.000 1	0.000 2	0.000 1	0.000 2	0.000 6	0.000 3	0.000 1	0.000 3	0.0003
Inter-lab. stand. dev.	0.03	0.04	0.06	0.04	0.05	0.11	0.07	0.03	0.03	0.05
Reproducibility variance	0.001	0.001	0.003	0.002	0.002	0.012	0.005	0.001	0.001	0.003
Repeatability stand. dev.	0.01	0.01	0.01	0.01	0.01	0.02	0.02	0.01	0.02	0.02
r limit	0.03	0.03	0.04	0.03	0.04	0.07	0.05	0.02	0.05	0.05
Repeatability RSD _r	4.5%	4.5%	2.4%	2.7%	2.9%	2.1%	3.1%	2.8%	4.8%	3.2%
Reproducibility stand. dev.	0.03	0.04	0.06	0.04	0.05	0.11	0.07	0.03	0.03	0.05
R limit	0.10	0.11	0.17	0.12	0.14	0.31	0.19	0.09	0.08	0.15
Reproducibility RSD _R	16.8%	17.4%	9.9%	9.5%	10.6%	9.5%	11.7%	11.1%	8.5%	9.5%
Horwitz RSD	4.74	4.68	4.04	4.22	4.18	3.66	4.04	4.49	4.38	4.08
HorRat _r	0.96	0.97	0.60	0.63	0.70	0.58	0.77	0.62	1.10	0.79
Horwitz RSD	7.18	7.09	6.12	6.40	6.34	5.54	6.13	6.80	6.63	6.18
HorRat _R	2.34	2.45	1.63	1.49	1.67	1.71	1.91	1.63	1.29	1.53

Table 3. Table of results obtained

COMPENDIUM OF INTERNATIONAL METHODS OF ANALYSIS-OIV
Determination of acetic acid in wines
by automated enzymatic method

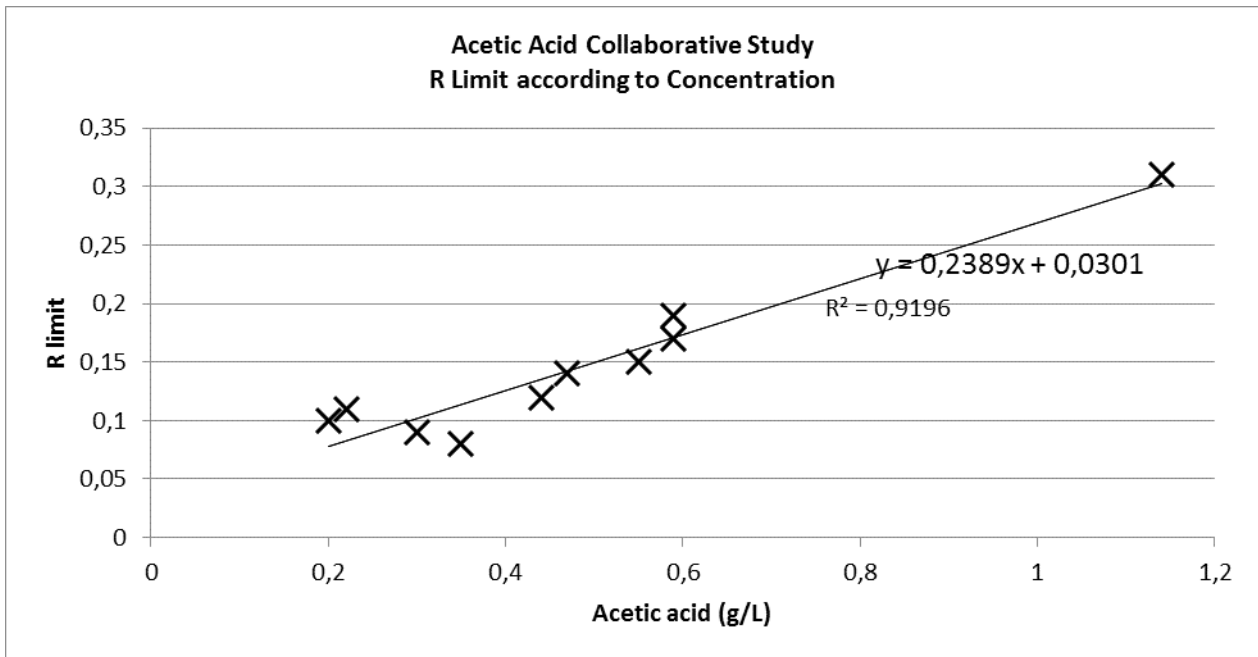

Figure 3. R limit according to concentration

Method OIV-MA-AS313-28

Type II method

**Determination of D-gluconic acid in wines and musts by
automated enzymatic method**
OIV-OENO 622-2019

1. Scope of application

This method makes it possible to determine D-gluconic acid in wines and musts by specific enzymatic analysis using an automatic sequential analyser, with concentrations of 0.06 g/L to 5.28 g/L of analyte (taking into account that the sample may be diluted).

2. Principle

The D-gluconate present in the sample is phosphorylated by adenosine triphosphate (ATP) during an enzymatic reaction catalysed by gluconate kinase (GK), to produce D-gluconate 6-phosphate and adenosine diphosphate (ADP).



In the presence of nicotinamide adenine dinucleotide phosphate (NADP), D-gluconate 6-phosphate oxidises to form ribulose 5-phosphate through the action of enzyme 6-phosphogluconate dehydrogenase (6-PGDH). The quantity produced of reduced nicotinamide adenine dinucleotide phosphate (NADPH) corresponds to that of D-gluconate-6-phosphate and, as such, of D-gluconic acid.



Reduced nicotinamide adenine dinucleotide phosphate (NADPH) is determined by spectrophotometry at 340 nm (the wavelength of maximum

COMPENDIUM OF INTERNATIONAL METHODS OF ANALYSIS-OIV
Determination of D-gluconic acid in wines and musts
by automated enzymatic method

absorption of NADPH). The NADPH concentration is proportional to the concentration of D-gluconic acid.

3. Reagents and working solutions

3.1. Reagents:

- 3.1.1. Distilled water for laboratory use, certified to the EN ISO 3696 standard
- 3.1.2. PIPES (Piperazine-1,4-bis[ethanesulfonic acid]) (CAS No. 5625-37-6)
- 3.1.3. β -NADP- Na_2 (β -Nicotinamide adenine dinucleotide phosphate, disodium salt) (CAS No. 24292-60-2)
- 3.1.4. $\text{MgCl}_2 \cdot 6\text{H}_2\text{O}$ (Magnesium chloride hexahydrate) (CAS No. 7791-18-6)
- 3.1.5. ATP- Na_2 (Adenosine 5'-triphosphate disodium salt) (CAS No. 987-65-5)
- 3.1.6. Gluconate kinase (GK) (EC 2.7.1.12)
- 3.1.7. 6-phosphogluconate dehydrogenase (6-PGDH) (EC 1.1.1.44)
- 3.1.8. D-gluconic acid sodium salt (CAS No.527-07-1), minimum purity $\geq 99\%$
- 3.1.9. NaOH (Sodium hydroxide) (CAS No. 1310-73-2)
- 3.1.10 . PVP K-90 (Polyvinylpyrrolidone K-90) (CAS No. 9003-39-8)

3.2. Working solutions

- 3.2.1. Reagent 1: dissolve 30.2 g PIPES (3.1.2) (100 mmol/L), 1 g β -NADP- Na_2 (3.1.3) (1.3 mmol/L), 5.28 g NaOH (3.1.9) and 5 g PVP K-90 (3.1.10) in 1 L distilled water (3.1.1). The pH should be in the 6.3-6.4 range. This solution is stable for at least 4 weeks at 2-8 °C.
- 3.2.2. Reagent 2: dissolve 30.2 g PIPES (3.1.2) (100 mmol/L), 1 g $\text{MgCl}_2 \cdot 6\text{H}_2\text{O}$ (3.1.4) (1.3 mmol/L), 4.84 g ATP- Na_2 (3.1.5) and 7.6 g NaOH (3.1.9) in 1 L distilled water (3.1.1). The pH should be in the 7.0-7.2 range. Add 10 KU kinase gluconate (3.1.6) and 10 KU 6-

COMPENDIUM OF INTERNATIONAL METHODS OF ANALYSIS-OIV
Determination of D-gluconic acid in wines and musts
by automated enzymatic method

phosphogluconate dehydrogenase (3.1.7). This solution is stable for at least 4 weeks at 2-8 °C.

3.3. Calibration solutions

Calibration solutions are prepared from the D-gluconic acid sodium salt (3.1.8), by weighing, in concentrations that cover the linear range of the method (0.06-2 g/L).

Note 1: The formulations described above are for preparing 1 L of reagent. Other volumes may be prepared according to the needs of the laboratory.

Note 2: Commercial kits are available for the determination of D-gluconic acid. The user should check that the kit includes the reagents mentioned above.

4. Apparatus

4.1. Sequential automatic analyser with temperature control (approximately 37 °C), adjusted to measure absorbance at 340 nm. The apparatus should have software that facilitates data acquisition and carries out the necessary calculations.

4.2. Spectrophotometer or photometer to measure absorbance at 340 nm

4.3. Glass, quartz or methacrylate cuvettes

4.4. Class-A glassware for regular laboratory use (flasks, pipettes, etc.)

4.5. Micropipettes

4.6. Analytical balance with a resolution of ± 0.0001 g

4.7. pH meter

5. Sample preparation

If necessary, follow the procedure for preparation of the corresponding sample:

5.1. Filter or centrifuge the samples if they contain suspended particles.

COMPENDIUM OF INTERNATIONAL METHODS OF ANALYSIS-OIV
Determination of D-gluconic acid in wines and musts
by automated enzymatic method

5.2. Degas samples that contain carbon dioxide through stirring under vacuum, an ultrasonic bath or any other means that makes it possible to reach the required level of degasification.

5.3. Samples with a concentration higher than the specified limit of linearity (2 g/L) should be diluted with distilled water (3.1.1). Multiply the concentration obtained by the dilution factor.

6. Procedure

Given that different types of analysers may be used, it is recommended to strictly follow the manufacturer's instructions. This is also applicable to commercial enzymatic kits.

The procedures are those detailed below (volumes are given by way of example).

6.1. Manual procedure

6.1.1. Preheat the reagents and photometer to 37 °C.

6.1.2. Add the following to a cuvette using a pipette:

	Reagent blank (RB)	Standard / Sample
Standard / Sample	-	33 µL
Distilled water	33 µL	-
Reagent 1	800 µL	800 µL

6.1.3. Mix and incubate for 1 min at 37 °C. Read the absorbance (A1) at 340 nm.

6.1.4. Add the following to the cuvette using a pipette:

Reagent 2	200 µL	200 µL
-----------	--------	--------

COMPENDIUM OF INTERNATIONAL METHODS OF ANALYSIS-OIV
Determination of D-gluconic acid in wines and musts
by automated enzymatic method

6.1.5. Mix and incubate for 10 min at 37 °C. Read the absorbance (A2) of the reagent blank, standard and sample at 340 nm.

6.2. Automated procedure

6.2.1 Introduce the following parameters into the automatic analyser (which complies with the requirements in paragraph 4.1):

Wavelength: 340 nm
Temperature: 37 °C
Analysis mode: 2 points (differential)
Sample volume: 10 µL
Volume of Reagent 1: 240 µL
Volume of Reagent 2: 60 µL

6.2.2 Programme an application in the analyser so that it performs the following sequence:

	Reagent blank (RB)	Standard / Sample
Standard / Sample	-	10 µL
Distilled water	10 µL	-
Reagent 1	240 µL	240 µL

Mix, incubate for 1-5 min and read the absorbance (A1). Then add:

Reagent 2	60 µL	60 µL
-----------	-------	-------

Mix, incubate for 10 min and read the absorbance (A2).

The apparatus takes regular measurements, which makes it possible to obtain reaction kinetics (Fig. 1).



Figure 1: Example of reaction kinetics

6.2.3. It is advisable to check the calibration by carrying out three controls spread out over the measurement range. Each laboratory should establish its own internal quality-control programme, as well as correction procedures in case the controls do not comply with the acceptable tolerance levels.

7. Calculations

Calculate the D-gluconic acid concentration using the following formula:

- If the calibration is carried out with one point (standard) and the blank:

$$\frac{(A2 - 0.81 \times A1)_{\text{Sample}} - (A2 - 0.81 \times A1)_{\text{Blank}}}{(A2 - 0.81 \times A1)_{\text{Standard}} - (A2 - 0.81 \times A1)_{\text{Blank}}} \times F \times \text{g/L}_{\text{Standard}} = \text{g/L}_{\text{Sample}}$$

- If the calibration is with a calibration line:

$$A = (A2 - 0.81 \times A1)_{\text{Sample}} - (A2 - 0.81 \times A1)_{\text{RB}}$$

COMPENDIUM OF INTERNATIONAL METHODS OF ANALYSIS-OIV
Determination of D-gluconic acid in wines and musts
by automated enzymatic method

The absorbance calculated (A) is interpolated on the calibration line (Fig. 2) to obtain the D-gluconic acid concentration. Multiply the concentration obtained by the dilution factor (F).

A1: absorbance of the Blank/Standard/Sample + Reagent 1

A2: absorbance of the Blank/Standard/Sample + Reagent 1 + Reagent 2

RB: reagent blank

0.81: factor of correction of the dilution of Reagent 1 (this may vary depending on the volumes used according to the formula $[\text{Sample vol.} + \text{Reagent 1}] / [\text{Sample vol.} + \text{Reagent 1} + \text{Reagent 2}]$).

F: factor of dilution of the sample (to be applied if necessary)

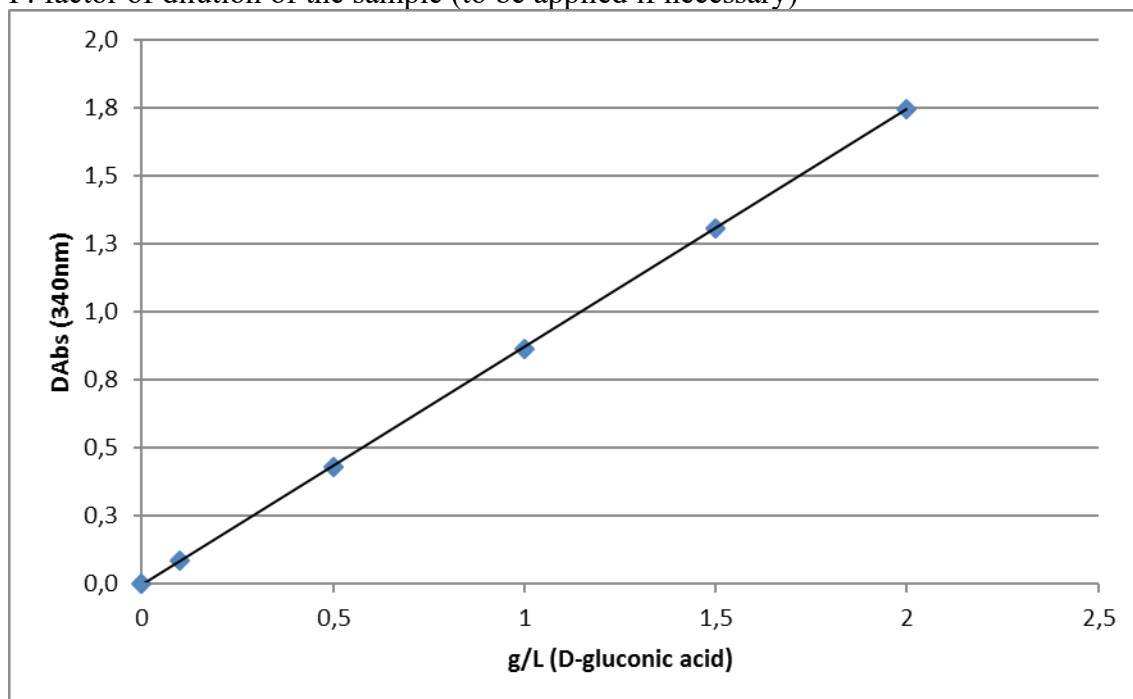

Figure 2: Example of a calibration line

8. Expression of results

The results are expressed in g/L to 2 decimal points, or in accordance with the uncertainty.

COMPENDIUM OF INTERNATIONAL METHODS OF ANALYSIS-OIV
Determination of D-gluconic acid in wines and musts
by automated enzymatic method

9. Automated enzymatic method characteristics

9.1. Repeatability

$$r = 0.0396x + 0.0098$$

With x representing the concentration of gluconic acid in g/L.

9.2 Reproducibility

$$R = 0.1226x + 0.0237$$

With x representing the concentration of gluconic acid in g/L.

9.3 Limit of quantification

Validated LoQ = 0.06 g/L

COMPENDIUM OF INTERNATIONAL METHODS OF ANALYSIS-OIV
Determination of D-gluconic acid in wines and musts
by automated enzymatic method

ANNEX

Results of the inter-laboratory study

1. Collaborative study

1.1. Participating laboratories: 19 laboratories participated from 6 different countries.

Laboratory	Country
Agroscope	Switzerland
Biosystems S.A	Spain
Bundesamt für Weinbau	Austria
Bundesinstitut für Risikobewertung (BfR)	Germany
Centrolab 2006, S.L	Spain
Comité Champagne Comité Interprofessionnel du vin de Champagne (CIVC)	France
Estación de Viticultura y Enología de Navarra (EVENA)	Spain
Estación de Viticultura y Enología Alcázar de San Juan	Spain
Estación Enológica de Castilla y León (ITACyL)	Spain
Estación Enológica de Haro	Spain
Federal College and Research Institute for Viticulture and Pomology (HBLA)	Austria
Freixenet S.A	Spain
Institut Català de la Vinya i el Vi (INCAVI)	Spain
Instituto dos Vinhos do Douro e do Porto (IVDP)	Portugal
Laboratoires Diœnos Rhône	France
Laboratoires Dubernet	France
Laboratorio Arbitral Agroalimentario	Spain
Landesuntersuchungsamt, Institut für Lebensmittelchemie und Arzneimittelprüfung	Germany
Miguel Torres, SA	Spain

For analysis, use 2 x 10 blind duplicate samples, with 1 repetition.

COMPENDIUM OF INTERNATIONAL METHODS OF ANALYSIS-OIV
Determination of D-gluconic acid in wines and musts
by automated enzymatic method

1.2. Samples

Sample	Vial	Type of sample
A	1 / 12	Moscatel
B	2 / 11	Concentrated must
C	3 / 13	Sulphited must
D	4 / 15	White wine
E	5 / 14	White wine
F	6 / 16	Rosé wine
G	7 / 10	Red wine
H	8 / 19	Red wine
I	9 / 18	Red wine
J	17 / 20	Synthetic matrix

COMPENDIUM OF INTERNATIONAL METHODS OF ANALYSIS-OIV
Determination of D-gluconic acid in wines and musts
by automated enzymatic method

Sample	A	B	C	D	E	F	G	H	I	J
Accepted labs	16	15	17	16	16	16	15	15	15	16
Repetitions	4	4	4	4	4	4	4	4	4	4
Minimum value	1.87	0.96	0.22	0.28	0.09	2.61	5.03	0.07	0.45	0.05
Maximum value	2.24	1.12	0.31	0.34	0.12	2.81	5.97	0.18	0.52	0.07
Mean value (g/L)	2.04	1.01	0.25	0.29	0.10	2.79	5.28	0.13	0.47	0.06
S _r	0.03	0.01	0.01	0.01	0.01	0.05	0.08	0.01	0.01	0.01
r limit = 2√2* S _r	0.09	0.02	0.02	0.02	0.03	0.13	0.22	0.02	0.02	0.02
RSD _r	1.48%	0.76%	2.13%	1.93%	8.53%	1.70%	1.50%	3.99%	1.70%	9.86%
S reproducibility (S _R)	0.09	0.04	0.03	0.02	0.01	0.13	0.24	0.03	0.02	0.01
R limit = 2√2* S _R	0.28	0.11	0.07	0.05	0.06	0.38	0.67	0.07	0.05	0.02
RSD _R	4.63%	3.96%	10.57%	5.89%	8.91%	4.81%	4.50%	19.21%	4.09%	12.49%
Horwitz RSD _r (%)	3.39%	3.77%	4.66%	4.54%	5.31%	3.23%	2.94%	5.12%	4.22%	5.84%
HorRat _r	0.44	0.20	0.46	0.43	1.61	0.53	0.51	0.78	0.40	1.69
Horwitz RSD _R (%)	5.08%	5.65%	6.99%	6.81%	7.96%	4.85%	4.40%	7.68%	6.34%	8.75%
HorRat _R	0.91	0.70	1.51	0.86	1.12	0.99	1.02	2.50	0.65	1.43

S: Standard deviation / RSD: Relative standard deviation / r: Repeatability limit /
R: Reproducibility limit

COMPENDIUM OF INTERNATIONAL METHODS OF ANALYSIS-OIV
Determination of D-gluconic acid in wines and musts
by automated enzymatic method

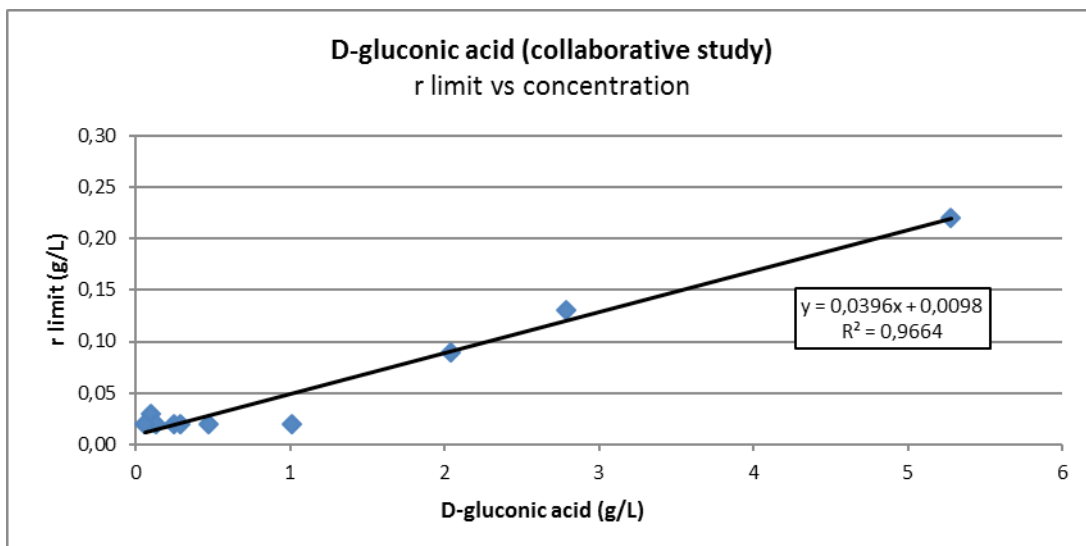

Figure 3: Repeatability limit according to concentration

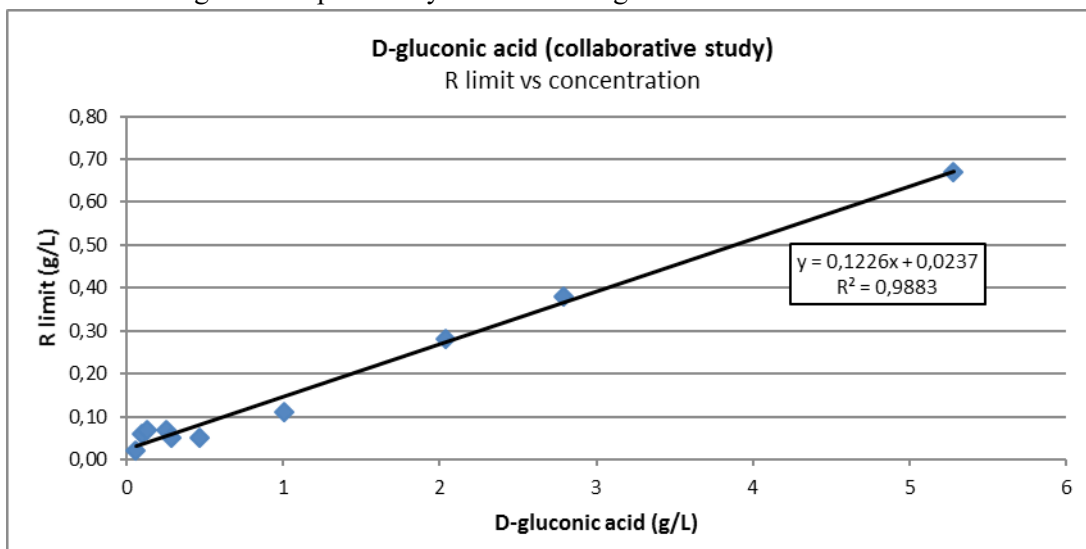

Figure 4: Reproducibility limit according to concentration

COMPENDIUM OF INTERNATIONAL METHODS OF ANALYSIS-OIV
Determination of D-gluconic acid in wines and musts
by automated enzymatic method

1.4. Manual method results

		A		B		C		D		E		F		G		H		I		J	
		1	12	2	11	3	13	4	15	5	14	6	16	7	10	8	19	9	18	17	20
2	Rep #1	2.05	2.09	1.06	0.99	0.25	0.25	0.34	0.33	<i>0.10</i>	<i>0.12</i>	2.85	2.84	5.32	5.34	0.14	0.13	0.45	0.46	0.05	0.05
	Rep #2	2.08	2.10	1.03	1.02	0.23	0.26	0.35	0.32	<i>0.09</i>	<i>0.10</i>	2.83	2.86	5.34	5.36	0.15	0.13	0.44	0.45	0.05	0.05
	$\bar{X}_{(2)}$	2.07	2.10	1.05	1.01	0.24	0.26	0.35	0.33	0.10	0.11	2.84	2.85	5.33	5.35	0.15	0.13	0.45	0.46	0.05	0.05
10	Rep #1	2.24	2.11	1.01	1.04	0.26	0.26	0.34	0.33	0.11	0.11	3.05	3.19	5.64	5.68	0.14	0.16	0.34	0.41	0.05	0.05
	Rep #2	2.37	2.24	1.01	1.06	0.25	0.26	0.35	0.34	0.12	0.11	3.10	3.02	5.65	5.78	0.14	0.15	0.33	0.42	0.05	0.05
	$\bar{X}_{(10)}$	2.31	2.18	1.01	1.05	0.26	0.26	0.35	0.34	0.12	0.11	3.08	3.11	5.65	5.73	0.14	0.16	0.34	0.42	0.05	0.05
18	Rep #1	2.61	2.54	1.04	0.99	0.27	0.28	0.34	0.34	0.13	0.12	3.44	3.38	5.97	6.22	0.21	0.23	0.44	0.47	0.05	0.05
	Rep #2	2.57	2.54	0.97	1.01	0.28	0.28	0.35	0.35	0.12	0.12	3.32	3.42	6.04	6.31	0.21	0.21	0.51	0.53	0.05	0.05
	$\bar{X}_{(18)}$	2.59	2.54	1.00	1.00	0.28	0.28	0.34	0.34	0.12	0.12	3.38	3.40	6.00	6.26	0.21	0.22	0.48	0.50	0.05	0.05

Table of data obtained. The values in italics are the results removed due to outliers from individual values according to the simple 2-tail Grubbs test and the double Grubbs test (2-tail, P = 2.5%), and according to the Cochran test (1-tail test where P = 2.5%).

COMPENDIUM OF INTERNATIONAL METHODS OF ANALYSIS-OIV
Determination of D-gluconic acid in wines and musts
by automated enzymatic method

Sample	A	B	C	D	E	F	G	H	I	J
Accepted labs	3	3	3	3	3	3	3	3	3	3
Repetitions	4	4	4	4	4	4	4	4	4	4
Minimum value	2.05	0.97	0.23	0.32	0.09	2.83	5.32	0.13	0.33	0.05
Maximum value	2.61	1.06	0.28	0.35	0.13	3.44	6.31	0.23	0.53	0.05
Mean value (g/L)	2.29	1.02	0.26	0.34	0.11	3.11	5.72	0.17	0.44	0.05
S _r	0.06	0.02	0.01	0.01	0.01	0.02	0.11	0.01	0.03	-
r limit = 2√2* S _r	0.16	0.07	0.02	0.03	0.02	0.04	0.31	0.03	0.10	-
RSD _r	0.03%	0.02%	0.03%	0.03%	0.06%	0.01%	0.02%	0.06%	0.08%	-
S reproducibility (S _R)	0.25	0.02	0.02	0.01	0.01	0.27	0.41	0.04	0.06	-
R limit = 2√2* S _R	0.70	0.07	0.05	0.03	0.03	0.77	1.14	0.12	0.17	-
RSD _R	0.11%	0.02%	0.06%	0.03%	0.10%	0.09%	0.07%	0.26%	0.14%	-
Horwitz RSD _r (%)	3.33%	3.76%	4.62%	4.44%	5.24%	3.18%	2.90%	4.94%	4.27%	-
HorRat _r	0.77	0.60	0.55	0.61	1.09	0.16	0.67	1.21	1.82	-
Horwitz RSD _R (%)	4.99%	5.64%	6.92%	6.66%	7.86%	4.77%	4.35%	7.41%	6.41%	-
HorRat _R	2.18	0.42	0.93	0.47	1.30	1.85	1.63	3.46	2.22	-

S: Standard deviation / RSD: Relative standard deviation / r: Repeatability limit /
R: Reproducibility limit. The statistical parameters were calculated taking into
account the results of the 3 laboratories.

COMPENDIUM OF INTERNATIONAL METHODS OF ANALYSIS-OIV
Determination of D-gluconic acid in wines and musts
by automated enzymatic method

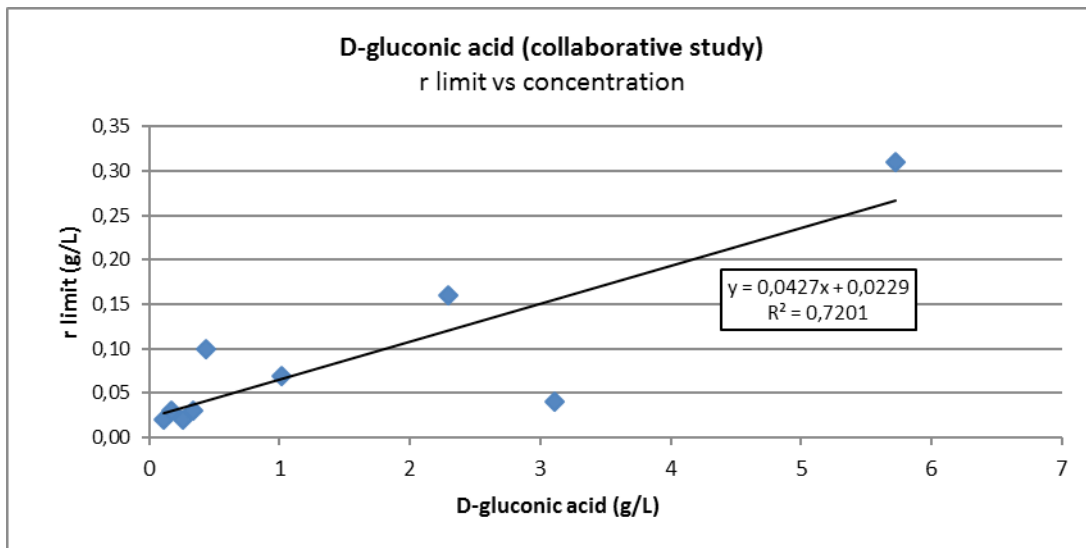

Figure 5: Repeatability limit according to concentration

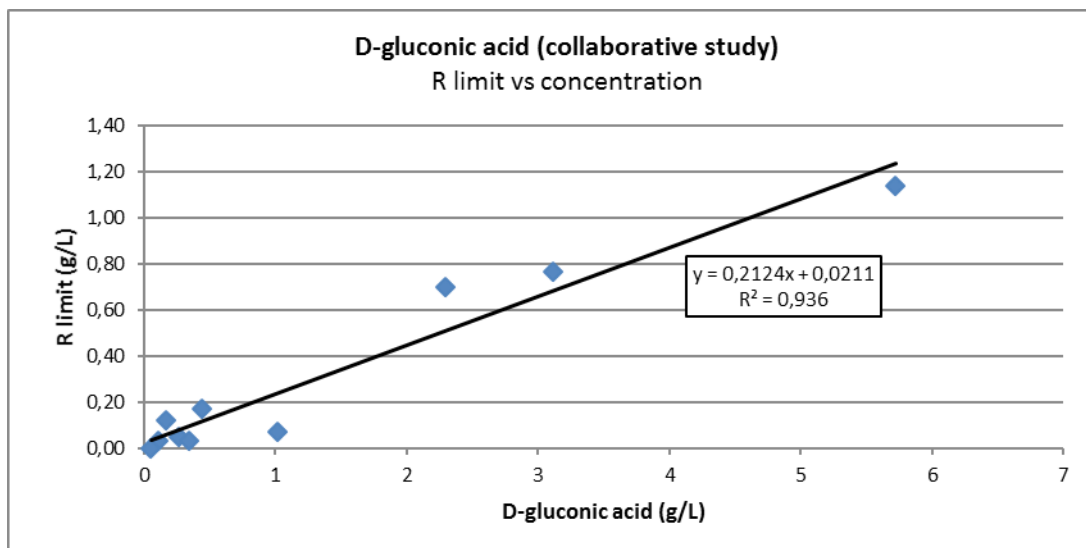

Figure 6: Reproducibility limit according to concentration

COMPENDIUM OF INTERNATIONAL METHODS OF ANALYSIS-OIV
Determination of D-gluconic acid in wines and musts
by automated enzymatic method

2. Bibliography

International Organisation of Vine and Wine (OIV), *Compendium of international methods of wine and musts analysis*, Vol. 1 & 2, 2019.

International Organisation of Vine and Wine (OIV), 'Collaborative Study', *Compendium of international methods of wine and must analysis*, OIV-MA-AS1-07: R2000.

International Organisation of Vine and Wine (OIV), 'Protocol for the design, conducts and interpretation of collaborative studies,' *Compendium of international methods of wine and must analysis*, OIV-MA-AS1-09: R2000.

ISO 13528:2015 (E). Protocol for the design, conducts and interpretation of collaborative studies. Second Edition.

Zoecklein, B. W., Fugelsang, K. C., Gump, B. H. & Nury, F.S., *Wine analysis and production*, Van Nostrand Reinhold, 1st edition, 31 December, 1990.

Carbone Dioxide

With a range of concentration up to 1.5 g/L

A 39 modified by OENO 21/2003

OENO 3/2006

OIV/OENO 377/2009

1. Principle

1.1 Still wines (CO_2 over pressure $\leq 0.5 \times 10^5 \text{ Pa}^*$)

The volume of wine taken from the sample is cooled to around 0°C and mixed with a sufficient quantity of sodium hydroxide to give a pH of 10-11. Titration is carried out with an acid solution in the presence of carbonic anhydrase. The carbon dioxide content is calculated from the volume of acid needed to change the pH from 8.6 (bicarbonate form) to 4.0 (carbonic acid). A blank titration is carried out in the same conditions on decarbonated wine in order to take account of the volume of sodium hydroxide solution taken up by the wine acids.

1.2 Sparkling and semi-sparkling wines

The sample of wine to be analyzed is cooled near to the freezing point. After removal of a sub-sample to be used as a blank after decarbonation, the remainder of the bottle is made alkaline to fix all the carbon dioxide in the form of Na_2CO_3 . Titration is carried out with an acid solution in the presence of carbonic anhydrase. The carbon dioxide content is calculated from the volume of acid solution needed to change the pH from 8.6 (bicarbonate form) to 4.0 (carbonic acid). A blank titration is carried out in the same conditions in decarbonated wine in order to take account of the volume of sodium hydroxide taken up by the wine acids.

2. Description of the method

2.1 *Still Wines*

(CO_2 over pressure $\leq 0.5 \times 10^5 \text{ Pa}$)

2.1.1 Apparatus

- Magnetic stirrer
- pH meter

* 1 bar = 10^5 Pascal (Pa)

Carbon dioxide

2.1.2 Reagents

- Sodium hydroxide solution, 0.1 M
- Sulfuric acid solution, 0.05 M
- Carbonic anhydrase solution, 1 g/L

2.1.3 Procedure

Cool the wine sample together with the 10 mL pipette used for sampling to approximately 0°C.

Place 25 mL sodium hydroxide solution, 0.1 M, in a 100 mL beaker; add two drops of carbonic anhydrase solution, 1 g/L. Introduce 10 mL of wine using the pipette cooled to 0°C.

Place the beaker on the magnetic stirrer, immerse the pH electrode and magnetic rod, and stir moderately.

When the liquid has reached room temperature, titrate slowly with the sulfuric acid solution, 0.05 M, until the pH reaches 8.6. Note the burette reading.

Continue titrating with the sulfuric acid until the pH reaches 4.0. Let n mL be the volume used between pH 8.6 and 4.0.

Remove CO₂ from approximately 50 mL of the wine sample by shaking under vacuum for three minutes, the flask being heated in a water bath to about 25 °C.

Carry out the above procedure on 10 mL of the decarbonated wine. Let n' mL be the volume used.

2.1.4 Expression of results

1 mL of the titrated sodium hydroxide solution, 0.05 M, corresponds to 4.4 mg of CO₂. The quantity of CO₂ in grams per liter of wine is given by:

$$0.44 (n - n')$$

The result is quoted to two decimal places.

Note: For wines which contain little CO₂ (CO₂ < 1 g/L), the addition of carbonic anhydrase to catalyze the hydration of CO₂ is unnecessary.

2.2 *Sparkling and semi-sparkling wines*

2.2.1 Apparatus

- Magnetic stirrer
- pH meter

2.2.2 Reagents

- Sodium hydroxide, 50% (m/m)
- Sulfuric acid solution, 0.05 M
- Carbonic anhydrase solution, 1 g/L

Carbon dioxide

2.2.3 Procedure

Mark the level of wine in the bottle and then cool until freezing begins.

Allow the bottle to warm up slightly, while shaking, until ice crystals disappear.

Remove the stopper rapidly and place 45 to 50 mL of wine in a measuring cylinder for blank titration. The exact volume removed, v mL, is determined by reading on the measuring cylinder after it has returned to room temperature.

Immediately after the blank sample has been removed, add 20 mL of the sodium hydroxide solution for a 750 mL bottle.

Allow the wine to reach room temperature.

Place 30 mL of boiled distilled water and two drops of the carbonic anhydrase solution into a 100 mL beaker. Add 10 mL of wine that has been made alkaline.

Place the beaker on the magnetic stirrer, set up the electrode and magnetic rod and stir moderately.

Titrate with the sulfuric acid solution, 0.05 M, slowly until the pH reaches 8.6. Note the burette reading.

Continue titrating slowly with the sulfuric acid, 0.05 M, until the pH reaches 4.0. Let n mL be the volume added between pH 8.6 and 4.0.

Remove CO₂ from the v mL of wine placed on one side for the blank titration by agitating under vacuum for three minutes, the flask being heated in a water bath at about 25 °C. Remove 10 mL of decarbonated wine and add to 30 mL of boiled distilled water, add two to three drops of sodium hydroxide solution, 50%, to bring the pH to 10 to 11. Then follow the above procedure. Let n' mL be the volume of sulfuric acid added, 0.05 M.

2.2.4 Expression of results

1 mL sulfuric acid, 0.05 M, corresponds to 4.4 mg of CO₂.

Empty the bottle of wine which has been made alkaline and determine to within 1 mL the initial volume of wine by making up to the mark with water, say V mL. The quantity of CO₂ in grams per liter of wine is given by the following formula:

$$0.44 \left(n - \frac{V - v + \dots}{20} \right)$$

The result is quoted to two decimal places.

2.3 Expression of Results

The excess pressure at 20°C ($P_{\text{aph}_{20}}$) expressed in Pascals is given by the formula:

$$P_{\text{aph}_{20}} = \frac{Q}{1,951 \times 10^{-5} (0,86 - 0,01A) (1 - 0,00144S)} - P_{\text{atm}}$$

where:

Q = CO₂ content in g/L of wine,

A = the alcoholic strength of wine at 20 °C,

S = the sugar content of the wine in g/L,

P_{atm} = the atmospheric pressure, expressed in Pascals.

2.4 Note

The procedure described below can be used as the usual method for wines containing less than 4 g per liter of carbon dioxide.

Prepare two samples of wine for analysis.

Open one of the samples after it has been cooled to approximately 5°C and immediately add 5 mL of a sodium hydroxide solution, 50% (*m/m*), for 375 mL of sample. Stopper immediately and mix. Place 10 mL of wine so processed into a beaker containing 40 mL of water and add 3 drops of carbonic anhydrase solution, 0.1 mg/mL. Titrate with a sulfuric acid solution, 0.02275 M, until reaching a pH of 8.6, then continue titrating to a pH of 4.0. The volume used to change the pH from 8.6 to 4.0 is *n* mL.

Remove the carbon dioxide from about 25 mL of wine, taken from the second sample, by agitation under a vacuum for about 1 min. into a 500 mL flask containing 3 drops of carbonic anhydrase solution. Add 0.33 mL of sodium hydroxide, 50% (*m/m*). Apply the above titration procedure to 10 mL decarbonated wine. Let *n'* mL be the volume of H₂SO₄, 0.02275 M used. 1mL corresponds to 200 mg of carbon dioxide per liter. The amount of wine analyzed for carbon dioxide, in milligrams per liter:

$$(n - n') \times 200 \times 1.013$$

BIBLIOGRAPHY

Reference method:

CAPUTI A, UEDA M., WALTER P. & BROWN T., *Amer. J. Enol. Vitic.*, 1970, **21**, 140-144.

SUDRAUD P., *F.V., O.I.V.*, 1973, n° 350.

GORANOV N., *F.V., O.I.V.*, 1983, n° 758.

BRUN S. & TEP Y., *F.V., O.I.V.*, 1981, n° 736 & 1982, n° 736 (bis).

- Collaborative Study -

**Titrimetric determination of carbon dioxide in sparkling and semi-
sparkling wines**

- Report on Results -

Goal of the study

The objective of the study is to determine the repeatability and reproducibility characteristics of the reference method (MA-E-AS314-01-DIOCAR) for the titrimetric CO₂ determination in sparkling and semi-sparkling wine.

O.I.V. definitions and limits for the CO₂ content are given with resolution OENO 1/2002.

Needs and purpose of the study

The reference method for the CO₂ determination includes no precision data. This collaborative trial was thus conducted.

Due to the analytical particularity, the conventional validation protocol was not able to be completely respected. Out of one bottle of sample only one independent determination could be done. Each bottle had to be considered as

individual. Therefore homogeneity testing within the pre-investigations for collaborative studies was impossible. In order to provide homogenous test material close co-operation with producers was necessary. Samples were obtained during the filling of the bottles on the filling line in a very short time space, thus that it must be assumed that the CO₂ is homogeneously distributed in all bottles.

This study was designed to be a blind duplicate test. The complete anonymity of the samples could not be guaranteed because the partners involved used different types of bottles and/or stoppers for the different samples. Therefore we had to rely on the honesty of the participating laboratories which were requested to perform the data analysis independently without any data modification.

Scope and applicability

1. The method is quantitative.
2. The method is applicable for the determination of CO₂ in sparkling and semi-sparkling wines to check that standards are respected.

Materials and matrices

The collaborative study included 6 different samples. All were sent in blind duplicate, so that in total 12 bottles were distributed to the participants.

Table 1. Samples and coding.

Sample	Bottle Code	Type
SAMPLE A	(Code 1 + 9)	sparkling wine
SAMPLE B	(Code 2 + 5)	semi-sparkling wine (“petillant”)
SAMPLE C	(Code 3 + 4)	sparkling wine
SAMPLE D	(Code 6 + 10)	semi- sparkling wine (“petillant”)
SAMPLE E	(Code 7 + 11)	semi- sparkling wine (“petillant”)
SAMPLE F	(Code 8 + 12)	sparkling wine (red)

Control measures

The method considered is already approved in practice. Only the missing precision data had to be determined within the collaborative study. A pre-trial was not required because most of the laboratories had been already using the reference method in routine analysis.

Method to be followed and supporting documents

- . Supporting documents were given to the participants (Covering letter Reference for method of analysis, Sample Receipt Form and Result Sheet).
- . The determination of CO₂ content in g/l should be expressed in g/l.

Data analysis

1. Determination of outliers was assessed by Cochran, Grubbs and paired Grubbs tests.
2. Statistical analysis was performed to obtain repeatability and reproducibility data.
3. HORRAT values were calculated.

Participants

13 laboratories from several different countries participated in the collaborative study. Lab-Code numbers were given to the laboratories. The participating laboratories have proven experience in the analysis of CO₂ in sparkling wine.

Table 2. List of participants.

Landesuntersuchungsamt D-56068 Koblenz GERMANY	Institut für Lebensmittelchemie und Arzneimittelprüfung D-55129 Mainz GERMANY
Landesuntersuchungsamt D-67346 Speyer GERMANY	Institut für Lebensmittel, Arzneimittel und Tierseuchen D-10557 BERLIN GERMANY
Servicio Central de Viticultura y Enologia E-08720 Villafranca Del Penedes SPAIN	Landesuntersuchungsamt D-54295 Trier GERMANY
Landesuntersuchungsamt D-85764 Oberschleißheim GERMANY	Instituto Agrario di S. Michele I-38010 S. Michele all Adige ITALIA
Chemisches Landes- u. Staatl. Veterinäruntersuchungsamt D-48151 Münster GERMANY	Ispettorato Centrale Repressione Frodi I-31015 Conegliano (Treviso) ITALY
Bundesamt für Weinbau A-7000 Eisenstadt AUTRIA Chemisches und Veterinäruntersuchungsamt D-70736 Fellbach GERMANY	BgVV D-14195 Berlin GERMANY

COMPENDIUM OF INTERNATIONAL METHODS OF ANALYSIS - OIV**Carbon dioxide****Results**

The uncertainty data are directly calculated for the CO₂ determination from the results submitted. For the assessment of the collaborative trial the Horrat-ratio is of relevance. For all samples a ratio of < 2 was obtained for r and R, convincing for a collaborative study. Table 3 shows the results of the CO₂ titration for each sample.

Table 3. Summarised results of the CO₂ determination.

CO₂	SAMPL E A	SAMPL E B	SAMPL E C	SAMPL E D	SAMPL E E	SAMPL E F
Mean [g/l]	9.401	3.344	9.328	4.382	4.645	8.642
r [g/l]	0.626	0.180	0.560	0.407	0.365	0.327
sr [g/l]	0.224	0.064	0.200	0.145	0.130	0.117
RSDr %	2.379	1.921	2.145	3.314	2.803	1.352
Hor	0.893	0.617	0.804	1.109	0.946	0.501
R [g/l]	1.323	0.588	0.768	0.888	0.999	0.718
sR [g/l]	0.473	0.210	0.274	0.317	0.357	0.256
RSDR %	5.028	6.276	2.942	7.239	7.680	2.967
HoR	1.245	1.331	0.728	1.599	1.711	0.726

Overpressure measurement of sparkling wines

OENO 21/2003
OIV/OENO 377/2009

1. PRINCIPLE

After thermal stabilisation and agitation of the bottle, the overpressure is measured using an aphrometer (pressure gauge). It is expressed in Pascals (Pa) (type 1 method).

2. APPARATUS

The apparatus, which measures the overpressure in bottles of sparkling and semi-sparkling wines, is called an aphrometer. It can be in different forms depending on the stopper of the bottle (metal capsule, crown, plastic or cork stopper).

2. 1. Bottles with capsules

It is made up of three parts (figure 1):

- The top part (a screw needle holder) is made up of a manometer, a manual tightening ring, an endless screw, which slips into the middle part, and a needle, which goes through the capsule. The needle has a lateral hole that transmits pressure to the manometer. A joint ensures the tightness of the whole thing on the capsule of the bottle.
- The middle part (or the nut) enables the centring of the top part. It is screwed into the lower part, which strongly holds onto the bottle.
- The lower part (clamp) is equipped with a spur, that slips under the ring of the bottle in order to hold the whole thing together. There are rings adaptable to every kind of bottle.

2. 2. Bottles with corks

It is made up of two parts (figure 2):

- The top part is identical to the previous apparatus, but the needle is longer. It is made up of a long empty tube with a pointer on one end to aid in going through the cork. This pointer can be moved and it falls in the wine once the cork has been pierced.

- The lower part is made up of a nut and a base sitting on the stopper. This is equipped with four tightening screws used to maintain everything on the stopper.

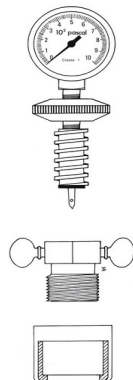

Figure 1
Aphrometer for capsules

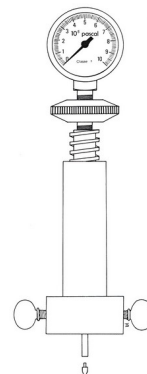

Figure 2
Aphrometer for stoppers

Remarks concerning the manometers that equip these two types of apparatuses:

- They can be either a mechanical Bourdon tube or digital piezoelectrical captors. In the first case, the Bourdon tube must be made of stainless steel.
- It is graduated in Pascals (Pa). For sparkling wine, it is more practical to use 10^5 Pascals (10^5 Pa) or kilopascal (kPa) as the unit of measurement.
- Aphrometers can be from different classes. The class of a manometer is the reading precision compared to the full scale expressed in percentages (e.g. manometer 1000 kPa class 1, signifies the maximum usable pressure 1000 kPa, reading at ± 10 kPa). Class 1 is recommended for precise measurements.

3. PROCEDURE

Measurements can be carried out on bottles if the temperature has stabilised for at least 24 hours.

After piercing the crown, the cork or plastic stopper, the bottle must be vigorously shaken to reach a constant pressure in order to make a reading.

3.1. Capsuled bottles

Slip the clamp's spur binders under the ring of the bottle. Tighten the nut until the whole thing is tight on the bottle.

The top part is screwed on the nut. To avoid loosing gas, piercing the capsule should be done as quickly as possible in order to bring the joint in contact with the capsule. The bottle must be shaken vigorously to reach a constant pressure in order to make a reading.

3.2. Bottles with stopper

Place a pointer at the end of the needle. Position this fixture on the cork. Tighten the four screws on the stopper.

Tighten the top part (the needle goes through the cork). The pointer should fall in the bottle so that the pressure can be transmitted to the manometer. Make a reading after shaking the bottle until reaching constant pressure. Recuperate the pointer after the reading.

4. EXPRESSION OF RESULTS

The overpressure at 20°C ($P_{ph_{20}}$) is expressed in Pascals (Pa) or in kilopascals (kPa).

This must be in accordance with the precision of the manometer (for example: $6.3 \cdot 10^5$ Pa or 630 kPa and not $6.33 \cdot 10^5$ Pa or 633 kPa for the manometer 1000 kPa full scale, of class 1).

When the temperature measurement is other than 20°C, it is necessary to correct this by multiplying the pressure measured by an appropriate coefficient (see Table 1).

0	1.85	13	1.24
1	1.80	14	1.20
2	1.74	15	1.16
3	1.68	16	1.13
4	1.64	17	1.09
5	1.59	18	1.06
6	1.54	19	1.03
7	1.50	20	1.00
8	1.45	21	0.97
9	1.40	22	0.95
10	1.36	23	0.93
11	1.32	24	0.91
12	1.28	25	0.88

TABLE 1: Relationship of $P_{aph_{20}}$ excess pressure of semi-sparkling and sparkling wine at 20°C with the P_{aph_t} excess pressure at temperature t

5. CONTROL OF RESULTS

Direct determination method of physical parameters (type 1 criteria method)

Verification of aphrometers

The aphrometers should be verified on a regular basis (at least once a year). Test beds are used for verification. This enables the comparison of the manometer to be tested and the reference manometer, of higher class, connected to national standards set up. The control is used to check the values indicated by the two apparatuses and increasing and decreasing pressures against each other. If there is a difference between the two, an adjustment can be made to make the necessary changes.

Laboratories and authorised bodies are equipped with such test beds, which are likewise available from manufacturers of manometers.

Method OIV-MA-AS314-03

Type II method

**Determination of the carbon isotope ratio $^{13}\text{C}/^{12}\text{C}$ of CO_2
in sparkling wines**

Method using isotope ratio mass spectrometry (IRMS)

(OENO 7/2005

OIV/OENO 377/2009

OIV-OENO 512-2014)

Foreword

The following standard method has been prepared with the agreement of all the laboratories participating in the OIV Collaborative study: ^{13}C -IRMS analyses of CO_2 in sparkling wine (2003-2004).

Introduction

The headspace in a bottle of sparkling wines contains a CO_2 -rich gaseous phase in equilibrium with the CO_2 dissolved in the liquid phase. This gas evolves during the second fermentation, induced by the addition of sugar from grape, beet, sugar cane or maize. However, the CO_2 content of sparkling wines may also be increased artificially with industrial CO_2 .

In 1997, an off-line method for the determination of the $^{13}\text{C}/^{12}\text{C}$ isotopic ratio of CO_2 from sparkling wines by isotope mass spectrometry (IRMS) was presented to the OIV. This method led on to new procedures based on automated on-line techniques, developed in some European laboratories. One of these procedures was presented to the OIV in 2001. Technical progress in the next few years may well lead to new procedures for determining reliably and rapidly the $^{13}\text{C}/^{12}\text{C}$ isotopic ratio of numerous samples of CO_2 . An exhaustive description of all applicable procedures for different techniques runs the risk of the method being rapidly superseded. The following method takes this into account and describes the basic principles for the correct measurement of the carbon-13 content in CO_2 from sparkling wine and includes a brief description of the procedures used nowadays and, by way of examples, some exhaustive descriptions of procedures based on off-line and on-line techniques.

1. Scope

This method determines by isotope mass spectrometry (IRMS) the stable carbon isotope ratio ($^{13}\text{C}/^{12}\text{C}$) of CO_2 in sparkling wines. The method includes a range of procedures whose use depends on the instruments available.

2. Normative references

ISO 5725-2:1994 “Accuracy (trueness and precision) of measurement methods and results. Part 2: Basic method for the determination of repeatability and reproducibility of a standard measurement method”.

ISO 78-2:1999 “Chemistry - Layouts for standards - Part 2: Methods of chemical analysis”.

3. Definitions

$^{13}\text{C}/^{12}\text{C}$: Isotope ratio of carbon 13 to carbon 12 for a considered sample;

$\square^{13}\text{C}$: Carbon 13 (^{13}C) content expressed in parts per mill (‰);

V-PDB: Vienna-Pee-Dee Belemnite. The PDB standard is a fossil calcium carbonate from South Carolina in USA, with an isotope ratio ($^{13}\text{C}/^{12}\text{C}$ or R_{PDB}) = 0.0112372. This value is the reference point for the common international PDB scale for $\square^{13}\text{C}$ values expressed in parts per mill (‰).

m/z: mass to charge relationship

S_r : Repeatability standard deviation. The standard deviation of test results obtained under repeatability conditions (conditions where independent test results are obtained with the same method on identical test samples in the same laboratory by the same operator using the same equipment within short intervals of time).

r: Repeatability limit. Value less than or equal to which the absolute difference between two test results obtained under repeatability conditions may be expected to be with a probability of 95%; $r=2.8 \cdot S_r$.

S_R : Reproducibility standard deviation. The standard deviation of test results obtained under reproducibility conditions (conditions where test results are obtained with the same method on identical test samples in different laboratories with different operators using different equipment).

R: Reproducibility limit. Value less than or equal to which the absolute difference between two test results obtained under reproducibility conditions may be expected to be with a probability of 95%; $R=2.8 \cdot S_R$

4. Principle

Plants are classified as C3 and C4 depending on the route followed for sugar synthesis. The sugar from C3 plants, such as grape and beet, has lower ^{13}C content than the sugar from C4 plants like cane sugar and maize. This difference is maintained in the ^{13}C content of the fermentation products of sugars such as ethanol and CO_2 . Moreover, the industrial CO_2 used in the food industry and that comes from the combustion of fossil fuels or from the thermal treatment of carbonates has ^{13}C content different from the products of C3 and C4 plants. Consequently, the $^{13}\text{C}/^{12}\text{C}$ isotope ratio of CO_2 from sparkling wine is governed by the type of sugar used in the second fermentation (C3 or C4) or by the isotopic composition of the industrial CO_2 added.

The studies performed till now on the ^{13}C content of CO_2 from sparkling wine have shown that the CO_2 obtained by fermentation of sugar from C3 plants has $\delta^{13}\text{C}$ in the range of -17‰ to -26‰, whereas CO_2 obtained by fermentation of sugar from C4 plants has $\delta^{13}\text{C}$ in the range of -7‰ to -10‰. Gasified wines have their $^{13}\text{C}/^{12}\text{C}$ isotope ratio below -29‰ or above -10‰, depending on the carbon dioxide source¹⁻⁴. Therefore, the measurement of the stable carbon isotope ratio ($^{13}\text{C}/^{12}\text{C}$) of CO_2 from sparkling wines can be a good method for finding the origin of the gas.

^{13}C content is determined from carbon dioxide gas obtained from sparkling wine. The various possible combinations of the ^{18}O , ^{17}O , ^{16}O and ^{13}C , ^{12}C isotopes lead to mass 44 corresponding to the $^{12}\text{C}^{16}\text{O}_2$ isotopomer, mass 45 corresponding to $^{13}\text{C}^{16}\text{O}_2$ and $^{12}\text{C}^{17}\text{O}^{16}\text{O}$ species, and mass 46 for the $^{12}\text{C}^{16}\text{O}^{18}\text{O}$ isotopomer ($^{13}\text{C}^{17}\text{O}^{16}\text{O}$ and $^{12}\text{C}^{17}\text{O}_2$ can be ignored due to their very low abundance). The corresponding ion currents are determined on the three different collectors. The ionic current m/z 45 is corrected for the contribution of $^{12}\text{C}^{17}\text{O}^{16}\text{O}$ which is computed from the intensity current measured for m/z 46 by including the relative abundance of ^{18}O and ^{17}O (Craig correction). Comparison with a reference calibrated against the international standard V-PDB then allows the calculation of the ^{13}C content on the $\delta^{13}\text{C}$ ‰ relative scale.

5. Reagents and material

The materials and consumables depend on the equipment used in the laboratory.

When the separation and purification of the CO_2 samples is performed by cryotrapping in a vacuum line the following reagents are used:

COMPENDIUM OF INTERNATIONAL ANALYSIS OF METHODS - OIV
Carbon isotope ratio $^{13}\text{C}/^{12}\text{C}$ of CO_2 in sparkling wines

- Liquid nitrogen
- Ethanol
- Solid CO_2

In general, the following consumables are used for the analysis with any Continuous Flow system (EA-IRMS or GC-C-IRMS). Other materials of similar quality can replace any product on this list:

- Helium for analysis (CAS 07440-59-7)
- Oxygen for analysis (CAS 07782-44-7)
- Carbon dioxide for analysis used as a secondary reference gas for carbon-13 content (CAS 00124-38-9).
- Oxidising reagent for the furnace of the combustion system, such as copper oxide for microanalysis (CAS 1317-38-0).
- Desiccant to remove water produced by combustion: for example, magnesium perchlorate for microanalyses (CAS 10034-81-4). This is not necessary when the EA-IRMS or the GC-C-IRMS systems remove water by cryotrapping.
- Capillary column and the Naphion membrane to remove water produced by combustion in GC-C-IRMS systems.

The Reference Gas used in the measurements can be a certified gas or a working reference gas calibrated compared to international references with known delta values (certified gases or reference materials). Some international reference materials that can be used for gas reference calibration and for control of the gas reference calibration are the following:

<u>Code sample</u>	<u>Material</u>	$\delta^{13}\text{C}_{\text{PDB}}$	
IMEP-8-A	CO_2	-6.40‰	from Messer Griesheim
ISO-TOP	CO_2	-25.7‰	“
BCR-656	Ethanol-20.91‰		from IRMM
BCR-657	Glucose	-10.76‰	“
SAI-692C	CO_2	-10.96‰	from Oztech Trading Cooperation (USA)
NBS-22	Oil	-29.7‰	from IAEA

COMPENDIUM OF INTERNATIONAL ANALYSIS OF METHODS - OIV
Carbon isotope ratio $^{13}\text{C}/^{12}\text{C}$ of CO_2 in sparkling wines

IAEA-CH-6 (ANU)	Sucrose-10.4‰	“	
NBS-18	Calcite	-5.1‰	“
NBS-19	TS-limestone	+1.95‰	“
FID-Mix	mixture of n-alkanes in isooctanol		from Varian
C14	-29.61‰		
C15	-25.51‰		
C16	-33.39‰		

6. Apparatus

The usual laboratory apparatus for carbon isotope ratio measurements and, in particular, the following:

- Isotopic ratio mass spectrometry (IRMS), with the ability to determine the ^{13}C content of CO_2 gas at natural abundance with an internal precision of 0.05 ‰ or better (expressed in relative \square value). The internal precision is defined here as the difference between two measurements of the same CO_2 sample.

The mass spectrometer will generally be fitted with a triple collector to measure simultaneously the current intensities for m/z 44, 45 and 46. The mass spectrometer should either be fitted with a dual-inlet system, for alternating measurement of the unknown sample and a standard, or use a continuous-flow technique (CF-IRMS).

- Continuous-flow systems (CF-IRMS). Continuous-flow systems with an automated gas sampling system can be used. Several commercially available CF-IRMS techniques suitable for the scope of the present method are:
 - GC-C-IRMS (Gas chromatography – combustion- IRMS)
 - EA-IRMS (Elemental analyser equipped for liquid or solid injection)

These systems separate and purify CO_2 and elute the resulting carbon dioxide to the ionisation chamber of the spectrometer.

- Gas Sampler-IRMS. A peripheral system may be used for the on-line gas preparation, isolation of CO_2 and introduction of CO_2 into the isotope ratio mass spectrometer.
- Glass or steel vacuum line, with cryogenic traps and connected to a pump able to obtain a pressure lower than $5 \cdot 10^{-3}$ mbar.
- Gas sampling devices, commercially available (such as syringe for gas samples) or designed in-house, able to extract a CO_2 aliquot from the sparkling wine without isotopic fractionation.

- Sealed vials for gas samples, adaptable on gas autosampler to the continuous-flow systems.
- Sealed vials for sparkling wine aliquots, adaptable on vacuum line and/or on gas autosampler to the continuous-flow systems.

7. Procedure

The proposed method includes three steps: CO_2 sampling, CO_2 purification and separation, and $^{13}\text{C}/^{12}\text{C}$ ratio measurement. These steps can be totally independent (off-line system) or fully or partially connected on-line (on-line system). Any procedure that avoids isotopic fractionation of the CO_2 sample during the three steps of the method may be used. Details on particular procedures based on off-line and CF systems are given in Annexes A, B and C.

The following description refers to the procedures used for the participant laboratories in the inter-laboratory test.

7.1. CO_2 sampling procedures:

- a. Sampling the CO_2 at room temperature from the headspace of the bottle by plugging a special device through the cork, or
- b. Sampling the CO_2 from the headspace of the bottle after removing the cork and sealing the bottle with a gas-tight precision lock connected to a sampling device. The sparkling wine bottle should be cooled to under 0°C before changing the locking device and then warmed to room temperature. An aliquot of gas collected in the sampling device is removed by a gas-tight syringe and injected into a sealed GC-vial, or
- c. Sampling the CO_2 from an aliquot of sparkling wine. The sparkling wine bottle should be cooled to $4^\circ\text{--}5^\circ\text{C}$ before removing the cork. The wine aliquots are placed in a special bottle adaptable to a glass vacuum line or to a gas autosampler.
- d. Refrigerate the sample at $4\text{--}5^\circ\text{C}$, before quickly transferring the liquid into a vial and sealing it with a Teflon-silicone septum cap. Then $50\ \mu\text{L}$ of liquid is then transferred into a 10 mL vial and analysed. If necessary, the vial should be filled with helium in order to remove the atmospheric CO_2 .
- e. After refrigerating the sample, the bottle is opened at room temperature and a sample of $200\ \mu\text{L}$ of liquid is taken using a pipette and placed in suitable vials. The vials are immediately resealed then placed in an ultrasonic bath for 10 min prior to analysis.

The statistical results of the inter-laboratory test for sampling procedures 7.1.d and 7.1.e are given in ANNEX E.

7.2. CO_2 purification and separation procedures

- a. Uncondensed gases and water present in the gas sample are removed in a vacuum line by use of cryogenic traps, or
- b. Gas samples are purified and CO_2 separated by different on-line systems, which are connected to the IRMS by means of continuous-flow or a cryogenic trap. Some of the on-line systems that can be used are the following:
 - a water cryogenic trap on-line with a continuous-flow system
 - a water trap (magnesium perchlorate) followed by a gas chromatograph
 - a gas chromatograph connected either directly to the IRMS or by means of a combustion interface.

7.3. $^{13}\text{C}/^{12}\text{C}$ ratio measurement:

The carbon isotope ratio of CO_2 obtained from sparkling wine is measured by using an isotopic ratio mass spectrometer.

8. Calculation

Express the $^{13}\text{C}/^{12}\text{C}$ isotope ratio of the CO_2 from sparkling wine as the deviation from a working standard ($\delta^{13}\text{C}$) previously calibrated in relation to the international standard PDB (Pee Dee Belemnite). This parameter is defined as the relative difference per thousand between the ^{13}C and ^{12}C ratios of a sample in relation to the PDB Standard. The PDB standard is a fossil calcium carbonate from South Carolina in USA, with an isotope ratio (R_{PDB}) = 0.0112372. This value is the reference point of the common international PDB scale for $\delta^{13}\text{C}$ values expressed in parts per mill (‰).

The $\delta^{13}\text{C}$ values expressed in relation to the working standard are calculated with the following equation:

$$\delta^{13}\text{C}_{\text{sam/ref}} (\text{‰}) = 1000 \times (R_{\text{sam}} - R_{\text{ref}}) / R_{\text{ref}}$$

where

R_{sam} is the $^{13}\text{C}/^{12}\text{C}$ isotope ratio of the test portion;

R_{ref} is the $^{13}\text{C}/^{12}\text{C}$ isotope ratio of the working standard.

COMPENDIUM OF INTERNATIONAL ANALYSIS OF METHODS - OIV Carbon isotope ratio $^{13}\text{C}/^{12}\text{C}$ of CO_2 in sparkling wines

The $\delta^{13}\text{C}$ values expressed in relation to the PDB standard are calculated using the following equation:

$$\delta^{13}\text{C}_{\text{sam/V-PDB}} (\text{‰}) = \delta^{13}\text{C}_{\text{sam/ref}} + \delta^{13}\text{C}_{\text{ref/V-PDB}} + (\delta^{13}\text{C}_{\text{sam/ref}} \times \delta^{13}\text{C}_{\text{ref/V-PDB}}) / 1000$$

where

$\delta^{13}\text{C}_{\text{ref/V-PDB}}$ is the isotopic deviation of the working standard previously determined from the PDB standard expressed in parts per mill (‰).

Express the results to two decimal places.

9. Precision

Details of the inter-laboratory test on precision of the method are given in annex D and E.

9.1. Repeatability

The absolute difference between two single results found on identical test sample by one operator using the same apparatus within the shortest feasible time interval will exceed the repeatability limit r in no more than 5% of the cases.

The accepted mean values of the standard deviation of repeatability (S_r) and repeatability limit (r) are equal to:

$$S_r = 0.21\text{‰} \quad r = 0.58\text{‰}$$

Characteristics of sampling procedures 7.1.a-c

$$S_r = 0.21\text{‰} \quad r = 0.56\text{‰}$$

Characteristics of sampling procedures 7.1.d and 7.1.e

9.2. Reproducibility

The absolute difference between two single results found on identical test sample reported by two laboratories will exceed the reproducibility R in not more than 5% of the cases.

The accepted mean values of the standard deviation of reproducibility (S_R) and reproducibility limit (R) are equal to:

$S_R = 0.47\%$ $R = 1.33\%$
Characteristics of sampling procedures 7.1.a-c

$S_R = 0.68\%$ $R = 1.91\%$
Characteristics of sampling procedures 7.1d and 7.1e

10. Test report

The test report shall contain the following data:

- all the information necessary for the identification of the sample tested;
- a reference to the International Standard Method;
- the method used, including the procedure for sampling and measurement and the instrument system used;
- the results of the test and units, including the results of the individual determinations and their mean, calculated as specified in clause 8 (“Calculation”);
- any deviations from the procedure specified;
- any unusual features observed during the test;
- the date of the test;
- whether repeatability has been verified;
- a description of the procedure for the reference gas calibration used to measure the test portions.

Annexes (A,B,C,D, E)

11. Bibliography

1. *Mesure du rapport isotopique $^{13}\text{C}/^{12}\text{C}$ du gaz carbonique des vins mousseux et des vins gazéifiés.* J. Merin and S. Mínguez. *Office International de la Vigne et du Vin. Paris. F.V. 1039, 2426/200297 (1997).*
2. *Examination of the $^{13}\text{C}/^{12}\text{C}$ isotopes in sparkling and semi-sparkling wine with the aid of simple on-line sampling.* M. Boner and H. Förstel. *Office International de la Vigne et du Vin. Paris. F.V. 1152. (2001).*
3. *Use of $^{13}\text{C}/^{12}\text{C}$ ratios for studying the origin of CO_2 in sparkling wines.* J. Dunbar. *Fresenius Z. Anal. Chem.*, 311, 578-580 (1982).
4. *Contribution to the study of the origin of CO_2 in sparkling wines by determination of the $^{13}\text{C}/^{12}\text{C}$ isotope ratio. I.* González-Martin, C. González-Pérez, E. Marqués-Macías. *J. Agric. Food Chem.* 45, 1149-1151 (1997).
5. *Protocol for Design, Conduct and Interpretation of Method-Performance studies.* *Pure Appl. Chem.*, 1995, 67, 331-343.

ANNEX A

Experimental procedure based on off-line systems for sampling and measurement **(“in-house” sampling device, off-line vacuum line and dual-inlet IRMS)**

1. Material

- Sampling device. The device that will be used to extract gas aliquots from the bottle consists of a hollow punch (steel needle) with three lateral orifices through which the gas enters. It is connected to a valve system composed of two valves connected in sequence and has a capacity of about 1 mL. One valve is attached to the punch (Valve 1) and the other is attached to a steel tube (Valve 2), which connects the device to a vacuum line. For a glass vacuum line an adapter with a flexible steel tube will be necessary. Figure shows the device for gas collection.
- Off-line vacuum line with two cryogenic traps ($P < 0.05$ mbar). Two types of vacuum line can be used, a glass or steel vacuum line.
- Dual-inlet - Isotope ratio mass spectrometer with the ability to determine the ^{13}C content of CO_2 gas at natural abundance with an internal precision of 0.05‰ or better (expressed in relative δ value). Internal precision is here defined as the difference between two measurements of the same CO_2 sample.

2. Procedure (see Figure)

2.1. CO_2 sampling:

1. Connect the sampling device to vacuum line and test its seal capacity.
2. Punch the sampling device with the valves closed into the bottle cork by means of a circular movement whilst maintaining the device vertical.
3. Connect the sampling device–wine bottle assembly to the vacuum line and evacuate the line and the reservoir delimited by the two valves (Valve 2 opened and Valve 1 closed).
4. Once a vacuum has been created in the reservoir, close valve 2, open valve 1 and maintain this configuration for 1 min. After the equilibration time, close valve 1. The gas retained in the reservoir is then purified.

2.2. CO_2 purification and separation:

1. Transfer the CO_2 collected in the reservoir to the first cryogenic trap by liquid nitrogen for at least 1 min, then pump the uncondensed gas until a pressure of less than 0.05 mbar is reached.
2. Transfer the CO_2 sample to the measurement device by using liquid nitrogen in the second cryogenic trap and by changing the liquid nitrogen in the first cryogenic trap for a water trap at -80 ± 5 °C. Maintain this for at least 1 min.
3. Pump the uncondensed gas (until a pressure of less than 0.05 mbar is reached) before closing the measurement device.

2.3. $^{13}\text{C}/^{12}\text{C}$ ratio measurement

The carbon isotope ratio of CO_2 obtained is measured by using a dual-inlet IRMS.

3. Reference

Mesure du rapport isotopique $^{13}\text{C}/^{12}\text{C}$ du gaz carbonique des vins mousseux et des vins gazeifiés. J.Merín, S.Mínguez. Office International de la Vigne et du Vin, F.V. 1039, 2426/200297.

ANNEX A

Diagrams of the off-line system

Gas sampling device

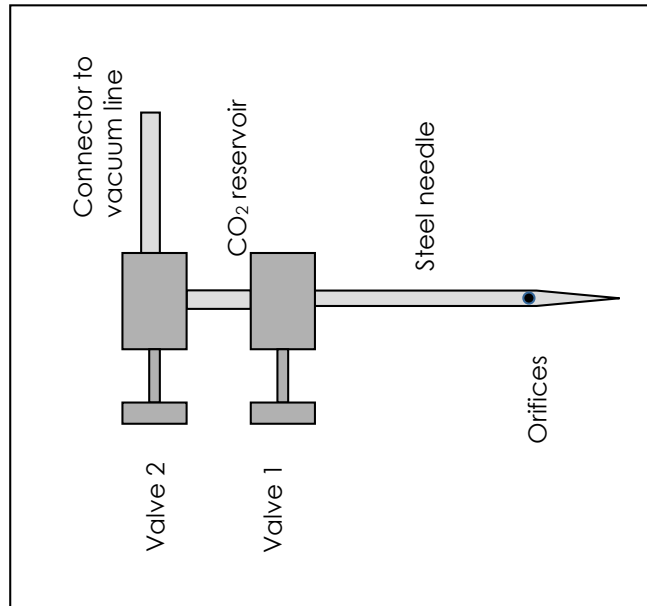

Gas Sampling and CO₂ purification

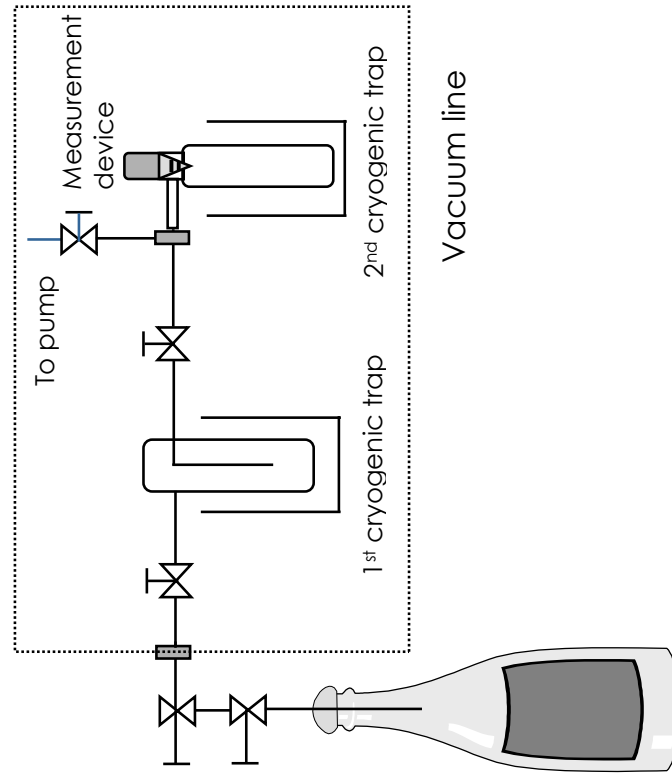

ANNEX B

Experimental procedure based on the on-line systems for sampling and measurement (CF-IRMS)

1. Sampling technique

At first the sampling system is evacuated, the carbon dioxide is extracted from the bottle using a “sampling device”, and a specific quantity is transferred to the storage vessel. After applying an overpressure, a small quantity of sample gas is introduced into the on-line helium flow with the aid of a restrictor. The sampling system is illustrated in Figure 2.

There is now a continuous carbon dioxide flow present in the helium flow (sample flow). The remaining helium flow is free from carbon dioxide and acts as the zero flow. Artificial “switching peaks” are generated by temporarily switching from the zero flow to the sample flow (switching time: 2 seconds), which are measured in the MS for their isotopic ratio.

2. Procedure (see Figure):

2.1. Evacuation of the sampling system

The entire sampling system is evacuated to a negative pressure of 1 mbar (V3 closed)

2.2. Sampling

The closure is pierced with a “sampling device” and the bottle atmosphere is transferred into the gas storage vessel (GV) with the aid of the negative pressure (pressure increase to approx. after 50 mbar). The fine adjustment valve (VF) permits a controlled and slow transfer of the gas. The gas is purified in the cryotrap during transfer.

2.3. Feeding

After sampling (V3, V2 closed, V4 open), an overpressure of 1,5 bar is built up with the aid of helium. The gas to be measured is fed to the CF-IRMS by opening V3. The measurement can be performed after a pre-run of 150 seconds. A capillary is integrated as a restrictor which only allows the feeding of a very small carrier gas quantity (10mL/min).

2.4. Measurement

A carbon dioxide flow is now continuously present in the helium sample flow (PRO). Switching from the sample flow (PRO) to the pure helium flow (NUL) permits the generation of artificial switching peaks.
Switching on the sample side: 2 seconds (zero side: 10-30 seconds).

3. Reference

Examination of the $^{13}\text{C}/^{12}\text{C}$ isotopes in sparkling and semi-sparkling wine with the aid of simple on-line sampling. M. Boner and H. Förstel. Office International de la Vigne et du Vin, FV 1152.

Diagram of the on-line system

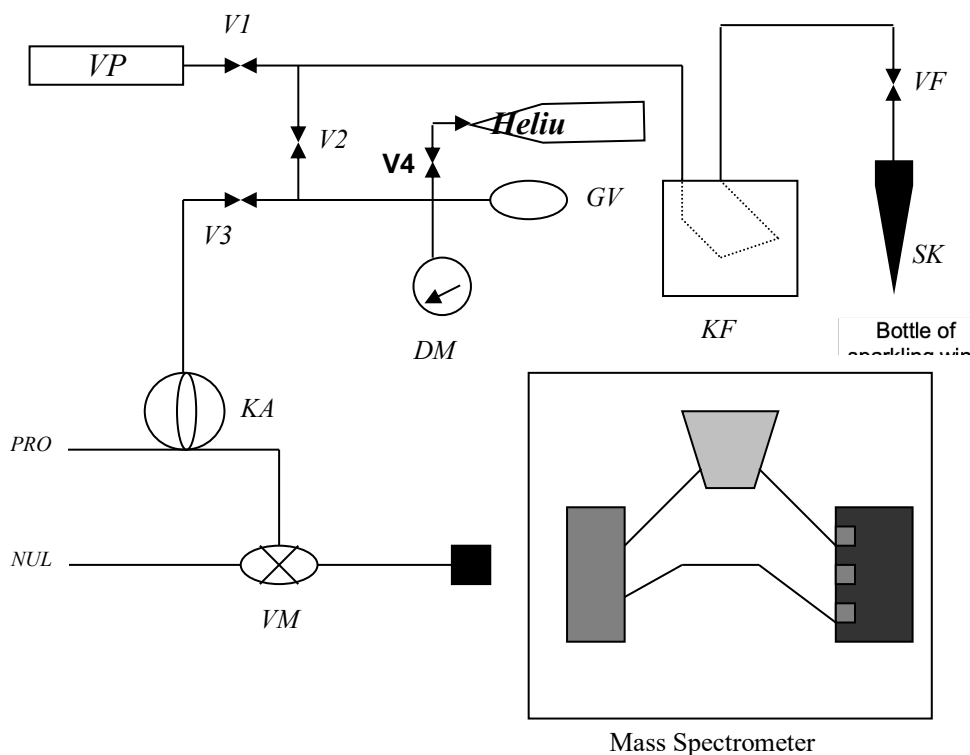

- V1-V4 check valve
- VP vacuum pump
- VF fine adjustment valve
- SK sampling device
- PRO helium sample flow (50 mL/min)
- NUL helium (zero) flow (60mL/min)
- KF water trap propanol at -90°C
- GV 250 ml gas storage vessel
- DM pressure gauge
- KA restrictor capillary (10cm, $150\mu\text{m}$)
- VM 2/4-way valve

ANNEX C

Experimental procedure based on the GC-C-IRMS technique

1. Instrument characteristics

- Gas Chromatograph: GC Varian 3400
- Capillary Column: HP-INNOWax (Crosslinked Polyethylene Glycol), 30 m x 0.25 mm ID, film thickness 0.5 μm
- Combustion interface by ThermoFinnigan-MAT, with oxidation oven set at 940°C or off; reduction oven at 640°C or off
- Mass Spectrometer: DeltaPlus ThermoFinnigan-MAT.
-

2. Procedure

2.1. CO_2 sampling:

1. Aliquots of gas were collected through a 25cc syringe, by plugging a long iron needle through the cork. CO_2 pressure filled the syringe with the headspace gas spontaneously.
2. Transfer the gas in already crimped vials for subsequent analysis. The vials used to store the gas are previously crimped with Teflon-silicone septum caps. To flush out the air inside – and thus the atmospheric CO_2 – a second needle is plunged into the septum, to guarantee that headspace gas from wine pushes out the air in vial. See figure below.

NOTE: A bigger syringe is used, in line with vial volume, to make sure the vial is clean. In our case, a 25cc (or even bigger) syringe for a 2 ml vial.

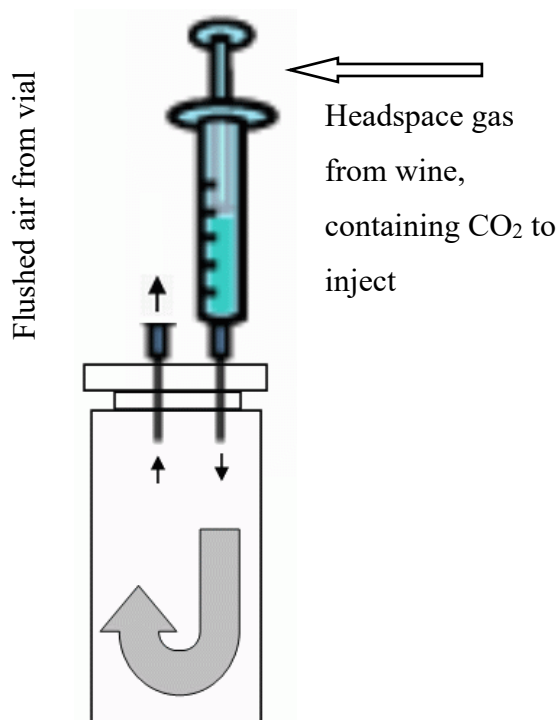

* Note that vial is not in scale with syringe.

2.2. GC-IRMS analyses: CO_2 injection and $^{13}\text{C}/^{12}\text{C}$ ratio measurement

A very few μL of gas were directly injected into the column with a 10 μL cemented-needle Hamilton syringe. Split conditions of high flow were set up. The carrier helium was at 20 PSI.

4 injections were carried out in each run for each sample. Total run time for the analysis was 6 minutes. See chromatogram below.

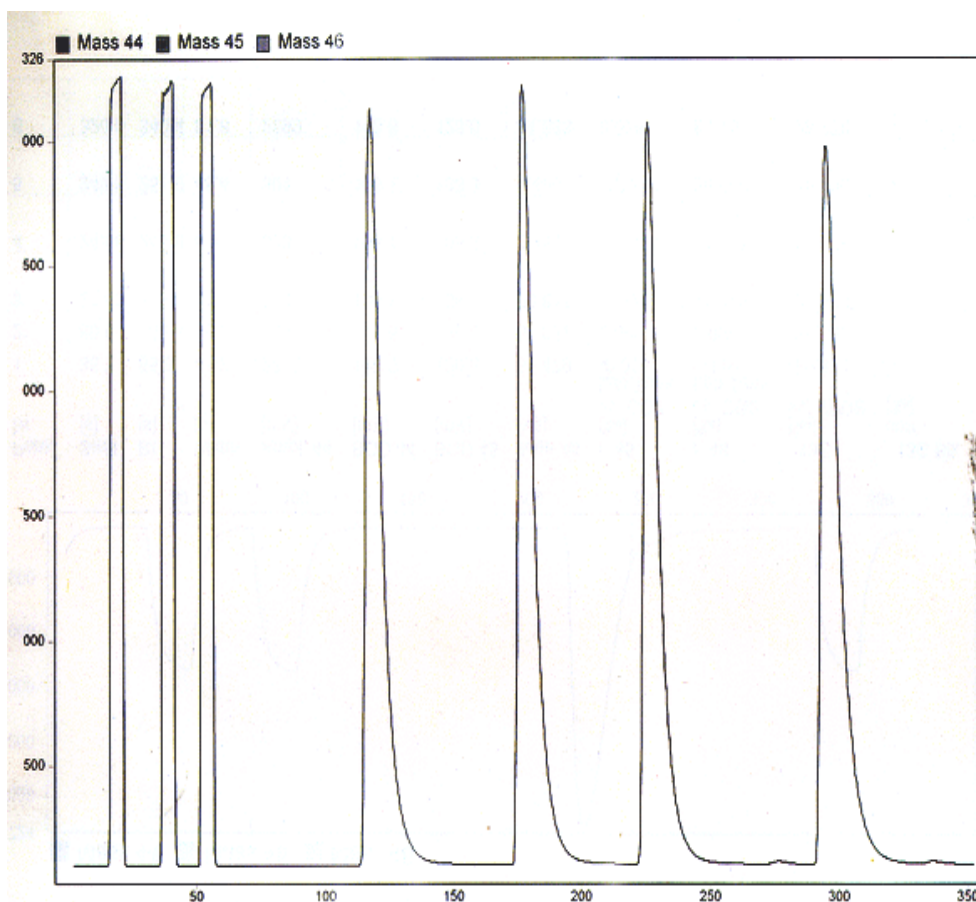

2.3. Processing of results

The software used to record and elaborate signals from the mass spectrometer, was version 1.50 of Isodat NT, from ThermoFinnigan-Bremen, running under MS-Windows NT OS.

For each sample, the mean $\delta^{13}\text{C}$ value is calculated as the average value of the last 3 injections. The $\delta^{13}\text{C}$ value of the first injection is systematically discarded.

ANNEX D
(informative)

Statistical results of the inter-laboratory test

In accordance with ISO 5725:1994, the following parameters were defined in an inter-laboratory test conducted by 11 European laboratories and a Mexican laboratory.

Year of the inter-laboratory test	2003-2004
Number of laboratories	12
Number of samples	5 in blind duplicates
Parameter	$\delta^{13}\text{C}$ of CO_2

Sample identification	A	B	C	D	E
Number of participating laboratories	12	12	12	12	12
Number of laboratories retained after eliminating outliers	12	11	12	12	12
Number of replicates per laboratory	2	2	2	2	2
Number of accepted test results	24	22	24	24	24
Mean ($\delta^{13}\text{C}$) ‰	-9.92	-20.84	-23.66	-34.80	-36.43
s_r^2	0.057	0.031	0.119	0.006	0.044
Repeatability standard deviation (S_r) ‰	0.24	0.18	0.35	0.08	0.21
Repeatability value, r ($2.8 \times S_r$) ‰	0.67	0.49	0.97	0.21	0.58
S_R^2	0.284	0.301	0.256	0.140	0.172
Reproducibility standard deviation (S_R) ‰	0.53	0.55	0.51	0.37	0.41
Reproducibility value, R ($2.8 \times S_R$) ‰	1.49	1.54	1.42	1.05	1.16

Sample types: A Sparkling wine - C_4 sugar
B Sparkling wine - C_3 sugar
C Sparkling wine - C_3 sugar
D Gasified wine
E Gasified wine

ANNEX E

Statistical results of the inter-laboratory test on sparkling
and gasified wines
Sampling procedures 7.1.d and 7.1.e

In accordance with method **OIV-MA-AS1-09: R2000**, the following parameters were defined as part of an inter-laboratory test conducted with 16 laboratories.

Year of the inter-laboratory test: 2013-2014
Number of laboratories: 16
Type of samples: Sparkling and gasified wines
Number of samples: 3, as blind duplicates
Parameter measured: $\square^{13}\text{C}$

INDICATORS	WINE NO. 1	WINE NO. 2	WINE NO. 3
Number of laboratories	16	14	16
Number of repetitions	2	2	2
Minimum	-32.90	-33.10	-23.64
Maximum	-29.83	-30.97	-20.57
Repeatability variance s_r^2	0.0467	0.0118	0.0648
Inter-group variance s_L^2	0.43853	0,29762	0.51616
Reproducibility variance s_R^2	0.4852	0.3094	0.5810
Overall average	-31.42	-31.83	-22.15
Repeatability standard deviation	0.22	0.11	0.25
r limit	0.612	0.307	0.720
Reproducibility standard deviation	0.70	0.56	0.76
R limit	1.971	1.574	2.157

Laboratory Code	A	B	A	B	A	B	Wine No. 1	Wine No. 2	Wine No. 3
Lab 1	-31.40	-31.69	-31.56	-31.88	-21.93	-22.12	-0.18	-0.19	0.16
Lab 2	-31.23	-31.29	-31.43	-31.41	-21.46	-22.04	0.23	-0.73	0.52
Lab 3	-32.65	-32.12	-32.15	-32.13	-23.41	-23.64	-1.39	-0.56	-1.81
Lab 4	-31.55	-31.50	-31.46	-31.66	-22.40	-22.54	-0.15	0.48	-0.42
Lab 5	-31.50	-31.30	-31.80	-31.90	-22.00	-22.30	0.03	-0.04	0.00
Lab 6	-31.46	-31.75	-31.96	-31.75	-22.39	-22.10	-0.27	-0.05	-0.13
Lab 7	-31.48	-30.66	-31.29	-29.35	-21.47	-20.57	0.50	2.71	1.48
Lab 8	-29.83	-30.17	-29.73	-31.35	-21.50	-21.96	2.04	2.31	0.55
Lab 9	-30.96	-30.90	-31.34	-31.21	-22.22	-22.27	0.70	0.99	-0.13
Lab 10	-32.34	-32.29	-32.68	-32.75	-23.25	-23.14	-1.29	-1.60	-1.37
Lab 11	-32.90	-32.70	-33.10	-33.10	-23.00	-23.50	-1.98	-2.29	-1.45
Lab 12	-31.91	-31.68	-32.22	-32.14	-22.58	-22.66	-0.54	-0.63	-0.62
Lab 13	-31.03	-31.10	-31.61	-31.68	-21.78	-21.74	0.51	0.33	0.51
Lab 14	-31.25	-30.93	-31.43	-31.54	-22.01	-22.02	0.57	0.62	0.17
Lab 15	-30.89	-30.88	-31.59	-31.47	-21.08	-21.07	0.76	0.53	1.41
Lab 16	-31.05	-30.98	-31.24	-30.97	-	-21.490	0.58	1.30	1.13
					21.090				

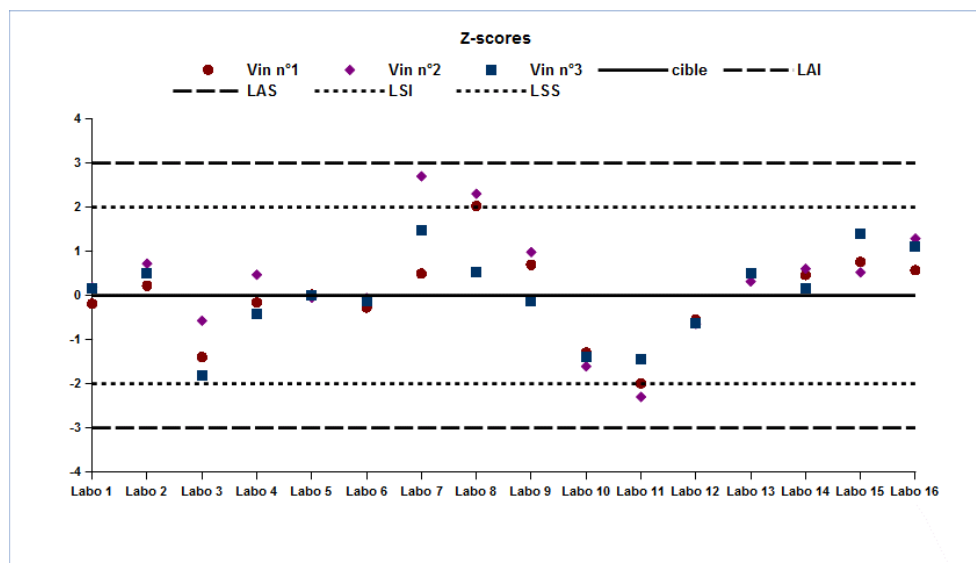

Bibliography

1. Ana I. Cabañero, Tamar San-Hipólito and Mercedes Rupérez, GasBench/isotope ratio mass spectrometry: a carbon isotope approach to detect exogenous CO_2 in sparkling drinks *Rapid Commun. Mass Spectrom.* 2007; 21: 3323–3328.
2. Laetitia Gaillard, Francois Guyon/, Marie-Hélène Salagoïty, Bernard Médina, Authenticity of carbon dioxide bubbles in French ciders through multiflow-isotope ratio mass spectrometry measurements. *Food Chemistry.* 2013, 141: 2103–2107

**Determination of carbon dioxide in wine
by manometric method
For a range of concentration from 0.5 g/L to 7 g/L
A39; OENO 21/2003;
OENO 2/2006
OIV/OENO 377/2009**

1. PRINCIPLE

The carbon dioxide in the sample is bound with 10 M sodium hydroxide. An Erlenmeyer flask with a side arm is connected to a manometer and the carbon dioxide is released with sulphuric acid from the prepared sample. The resultant increase in pressure is measured. It allows quantifying carbon dioxide content.

2. REAGENTS

- 2.1. Freshly distilled or deionised water;**
- 2.2. Sodium hydroxide** (purity >98%);
- 2.3. Sulphuric acid** (purity >95-97%);
- 2.4. Sodium carbonate** anhydrous (purity >99%).

Preparation of the reagents

2.5. 10 M Sodium hydroxide: dissolve 100 g of sodium hydroxide (2.2) in 200 ml water (2.1) and make up to 250 ml in a volumetric flask.

2.6. Sulphuric acid, about 50% (v/v): cautiously add concentrated sulphuric acid (2.3) to an equal volume of water (2.1). Mix well by stirring. Cool to room temperature.

2.7. Carbon dioxide standard solution 10 g/l: dry anhydrous sodium carbonate (2.4) in an oven at 260°C-270°C over night, and cool to room temperature in a desiccator. Dissolve 6.021 g of dry sodium carbonate in water (2.1) and make up to 250 ml in a volumetric flask.

2.8. Carbon dioxide calibration solutions 0.4; 1; 2; 4 and 6 g/l: with pipettes take 2, 5, 10, 20 and 30 ml of the standard solution (2.7) in separate 50 ml volumetric flasks and make up to 50 ml with water (2.1).

**COMPENDIUM OF INTERNATIONAL ANALYSIS OF METHODS -
OIV
Carbon Dioxide - Manometric Method**

3. APPARATUS

- 3.1. 250 ml and 50 ml volumetric flasks;**
- 3.2. Oven;**
- 3.3. Dessicator;**
- 3.4. Balance with an accuracy of ± 0.1 mg;**
- 3.5. Refrigerator or water-ethylene glycol bath, -4°C ;**
- 3.6. Electronic density meter or pycnometer and thermostatic water bath, 20°C ;**
- 3.7. Pipettes 0.5, 2, 3, 5, 10, 20 and 30 ml;**
- 3.8. 100 ml cone-shaped vial, large ground-glass mouth;**
- 3.9. Digital manometer (allowing measures up to 200 kPa with an accuracy of 0.1kPa);**
- 3.10. Reaction flask: 25 ml Erlenmeyer flask with a 3 ml side arm and a three-way valve (see figure 1);**
- 3.11. Vacuum system (i.e. water suction pump).**
- 3.12 Separation funnel**

4. PROCEDURE

4.1. Sample preparation

Prepare the sample in duplicate. Cool the sample in a refrigerator overnight or in a -4°C water-ethylene glycol bath for 40 min. Place 3 ml of 10 M sodium hydroxide solution (2.5) in a 100 ml cone-shaped vial. Weigh the flask with contents at an accuracy of 0.1 mg. Pour approximately 75 ml of the cooled sample in the cone-shaped vial containing the sodium hydroxide solution. Weigh the flask with contents at an accuracy of 0.1 mg. Mix and allow to warm up to room temperature.

4.2. Determination of carbon dioxide content

Transfer 2 ml of the prepared sample (4.1) into the reaction flask. Connect the flask to the manometer via the open three-way valve. Pipette 0.5 ml of 50% sulphuric acid (2.6) into the side arm. Secure the three-way valve and the side arm stopper with clips. Note the air pressure. Close the three-way valve. Mix the contents by tilting and shaking vigorously. Note the pressure. The prepared sample can be diluted with water if necessary.

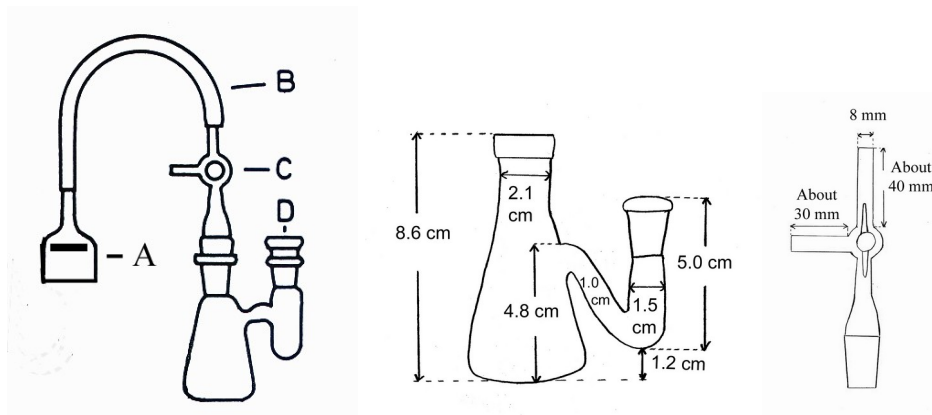

Fig.1 Apparatus. A manometer, B rubber hose, C three-way valve, D reaction flask (left) and approximate measures of the glassware (centre and right).

4.3. Calibration

Determine the carbon dioxide content of the calibration solutions as described above (4.2). Measure three calibration solutions which are within the expected concentration range of the sample. These calibration solutions are measured in duplicate.

**COMPENDIUM OF INTERNATIONAL ANALYSIS OF METHODS -
OIV
Carbon Dioxide - Manometric Method**

4.4. Measurement of the density of the sample

Remove carbon dioxide from the sample by shaking the sample first in a separation funnel and then for 3 min in a vacuum generated by a water suction pump. Measure the density of the sample either with an electronic density meter or a pycnometer.

5. CALCULATION

Calculate the pressure increase caused by the carbon dioxide released from each calibration solution and construct a calibration graph.

Calculate the slope (a) and bias (b) of the calibration graph.

Volume V (ml) of the prepared sample:

$$V = [(m_2 - m_1) \times 1000] / d \quad (1)$$

where

m_1 (g) = weight of (flask + 3 ml NaOH);

m_2 (g) = weight of (flask + 3 ml NaOH + sample);

d (kg/m³) = density of sample.

Pressure increase p_i caused by the carbon dioxide released from the prepared sample:

$$p_i = p_s - p_{ap} \quad (2)$$

where

p_s = manometer reading after releasing the carbon dioxide from the sample

p_{ap} = manometer reading before addition of H₂SO₄ (i.e. air pressure)

Concentration of carbon dioxide, C, in the sample (g/l) is given by:

$$C = [(p_i - b) / a] \times [(V + 3) / V] \times L \quad (3)$$

where

p_i = increase of pressure (equation 2)

a = slope of calibration graph

b = bias of calibration graph

V = sample volume (equation 1)

L = dilution factor in case the sample is diluted after sample preparation

**COMPENDIUM OF INTERNATIONAL ANALYSIS OF METHODS -
OIV
Carbon Dioxide - Manometric Method**

Content of carbon dioxide in % by weight:

$$\text{CO}_2 \% (\text{w/w}) = C \times 100/d \quad (4)$$

Example of the calculation of the content of carbon dioxide:

Calibration

Conc of STD g/l	Air pressure mbar	Pressure std mbar	Pressure increase mbar
2	1021	1065	44
2	1021	1065	44
4	1021	1101	80
4	1021	1102	81
6	1021	1138	117
6	1021	1138	117

slope	18.25000
intercept	7.50000
correlation	0.99995

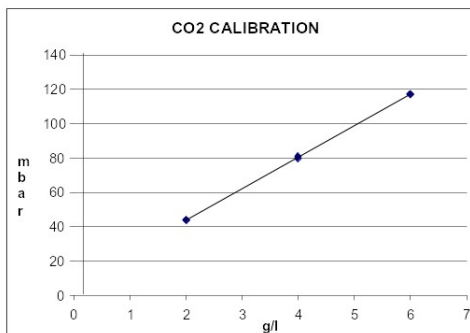

Calculation of the content of CO₂

SAMPLE	Density d (kg/m ³)	Flask + NaOH m1 (g)	Flask NaOH+ sampe m2 (g)	Air	Sample	p _s -p _{ap}	Sample V (ml)	CO ₂ g/l	Mean CO ₂ g/l
				pressure p _{ap} (mbar)	pressure p _s (mbar)				
Sparkling wine 1	1027.2	84.6287	156.162	1021	1112	91	69.64	4.77	
Sparkling wine 1	1027.2	84.6287	156.162	1021	1113	92	69.64	4.83	4.80
Sparkling wine 2	1025.3	86.1066	153.4407	1021	1118	97	65.67	5.13	
Sparkling wine 2	1025.3	86.1066	153.4407	1021	1118	97	65.67	5.13	5.13

6. VALIDATION

6.1. Performance criteria

- Standard deviation estimated from duplicates, $s_o = 0.07$ g/l
- Relative standard deviation, RSD = 1.9%
- Repeatability, $r = 5.6$ %
- Expanded measurement uncertainty ($k = 2$), $U = 3.8\%$
- Calibration range 0.4-6 g/L
- Determination range 0.3 -12 g/L (samples with concentration above 6 g/L should be diluted 1:2 with water to fit the calibration range)
- Detection limit 0.14 g/L
- Quantification limit 0.48 g/L

**COMPENDIUM OF INTERNATIONAL ANALYSIS OF METHODS -
OIV
Carbon Dioxide - Manometric Method**

Annex A

Literature

European Brewery Convention Analytica-EBC, Fourth edition, 1987, 9.15 Carbon dioxide.

OIV, SCMA 2002, FV N° 1153, determination of carbon dioxide in alcoholic beverages by a modified EBC method

OIV, SCMA 2004, FV N° 1192, determination of carbon dioxide in alcoholic Beverages by a modified EBC method, Statistical results of the collaborative study

OIV, SCMA 2005, FV N° 1222, comparison of the titrimetric method and the modified EBC method for the determination of carbon dioxide in alcoholic beverages

Ali-Mattila, E. and Lehtonen, P., Determination of carbon dioxide in alcoholic beverages by a modified EBC method, Mitteilungen Klosterneuburg 52 (2002): 233-236

Annex B

Statistical results of the collaborative study

DETERMINATION OF CARBON DIOXIDE IN ALCOHOLIC BEVERAGES BY A MODIFIED EBC METHOD

1. Goal of the study

The objective of the study was to determine the repeatability and reproducibility of the modified EBC method for the determination of carbon dioxide in wines, sparkling wines, ciders and beers.

2. Needs and purpose of the study

Fermentation produces carbon dioxide in alcoholic beverages. In the production of sparkling wines, carbon dioxide is one of the most essential products and it can also be added to certain alcoholic beverages. Carbon dioxide modifies the taste and aroma and is a preserving agent in alcoholic beverages.

In accordance with the definitions of the International Code of Oenological practices, sparkling wine should have an excess pressure of not less than 3 bar due to carbon dioxide in solution, when kept at a temperature of 20°C in closed containers. Correspondingly semi-sparkling wine should have an excess pressure of not less than 1 bar and not more than 2,5 bar. Excess pressure of, 3 bar, 2,5 bar and 1 bar correspond at 20°C about, 5.83 g/L, 5.17 g/L and 3.08 g/L of carbon dioxide in solution, respectively.

There is currently no practical and reliable method for the determination of carbon dioxide in alcoholic beverages. The wide variation in carbon dioxide results in international proficiency tests is a clear indication of the fact that there is a need for a reliable method.

3. Scope and applicability

The proposed method is quantitative and it is applicable for the determination of carbon dioxide in alcoholic beverages. This method was validated in a collaborative study for the determination of carbon dioxide in wine, beer, cider and sparkling wine via the analyses at levels ranging approximately from 0.4 g/L to 12 g/L (Note: the actual calibration level ranges from 0,4 g/L to 6 g/L). The samples should be diluted with water to this level in case the carbon dioxide content is higher than 6 g/L).

**COMPENDIUM OF INTERNATIONAL ANALYSIS OF METHODS -
OIV
Carbon Dioxide - Manometric Method**

4. Materials and matrices

The collaborative study consisted of 6 different samples. All except the beer samples were sent in blind duplicate, so that in total 12 bottles were distributed to the participants: two beers, two ciders, two red wines, two white wines, two pearl wines and two sparkling wines. Each bottle was coded individually for each participant. All samples were delivered in original bottles and the labels were removed from all samples except the sparkling wine samples. Measuring the amount of carbon dioxide in 10 bottles of the same lot number tested the homogeneity of the samples.

5. Practice samples

Four control samples were sent to participants to familiarize them with the method. . These samples included one beer, one wine, one pearl wine and one sparkling wine sample.

6. Method to be followed and supporting documents

The method and an Excel table for the calculation of results were sent to participants.

Supporting documents were also given, including the covering letter, sample receipt form, and result sheets.

7. Data analysis

7.1. Determination of outliers was assessed by Cochran's test, Grubbs' test and bilateral Grubbs test.

7.2. Statistical analysis was performed to obtain repeatability and reproducibility data.

8. Participants

Nine laboratories in different countries participated in the collaborative study. Lab-codes were given to the laboratories. The participating laboratories have proven experience in the analysis of alcoholic beverages.

Alcohol Control Laboratory
Alko Inc.
P.O.Box 279
FIN-01301 Vantaa
Finland

Altia Ltd
Valta-akseli
Rajamäki
Finland

Arcus AS
Haslevangen 16
P.O.Box 6764 Rodeløkka
0503 Oslo

ARETO Ltd
Mere pst 8a
10111 Tallinn
Estonia

**COMPENDIUM OF INTERNATIONAL ANALYSIS OF METHODS -
OIV**

Carbon Dioxide - Manometric Method

Norway

Bundesamt für Weinbau
Gölbeszeile 1
A-7000 Eisenstadt
Austria

Comité Interprofessionnel du
Vin de Champagne
5, rue Henri MARTIN
BP 135
51204 EPERNAY CEDEX
France

High-Tec Foods Ltd
Ruomelantie 12 B
02210 Espoo
Finland

Institut für Radioagronomie
Forschungszentrum
Jülich GMBH
Postfach 1913
52425 JÜLICH
Germany

Systembolagets laboratorium
Armaturvägen 4,
S-136 50 HANINGE
Sweden

**COMPENDIUM OF INTERNATIONAL ANALYSIS OF METHODS -
OIV
Carbon Dioxide - Manometric Method**

9. Results

The homogeneity of the samples was determined by measuring the carbon dioxide content in 10 bottles of the same lot number at the Alcohol Control Laboratory (Finland). Samples with the corresponding lot numbers were sent to the participants:

CO ₂ g/L	Beer 1	Beer 2	Cider	White wine	Red Wine	Pearl wine	Sparkling wine
Mean	5.191	5.140	4.817	1.337	0.595	5.254	7.463
s	0.020	0.027	0.025	0.036	0.038	0.022	0.046

According to the homogeneity test the CO₂ content in the two beers was the same and therefore they were considered as blind duplicates.

The individual results for all samples and laboratories of the collaborative study are given below.

Lab code	Beer 1	Beer 2	Cider 1	Cider 2	White wine 1	White wine 2	Red wine 1	Red wine 2	Pearl wine 1	Pearl wine 2	Sparkling wine 1	Sparkling wine 2
A	5,39	5,08	4,75	4,91	1,25	1,11	0,54	0,54	5,15	5,22	6,93	6,91
B	4,76	5,53	4,71	4,70	1,90 ³	1,78 ³	0,73 ²	1,19 ²	5,85 ³	5,93 ³	7,66 ³	7,72 ³
C	5,15	5,14	4,93	4,94	1,36	1,41	0,51	0,48	5,23	5,33	7,33	7,36
D	3,13 ¹	3,95 ¹	4,36 ¹	0,38 ¹	1,11 ¹	1,11 ¹	0,43 ¹	0,38 ¹	4,47 ¹	4,29 ¹	5,54 ¹	5,52 ¹
E	4,87	4,73	4,96	4,78	1,52	1,52	0,78 ³	0,80 ³	4,98	4,94	5,83	6,17
F	5,34	4,91	4,71	5,01	1,33	1,40	0,46	0,57	5,22	4,95	6,52	6,67
G	5,18	5,15	4,82	4,86	1,37	1,36	0,56	0,59	5,22	5,27	7,54	7,47
H	5,42	5,40	5,05	5,12	1,15	1,30	0,52	0,53	5,12	5,10	7,25	7,34
I	5,14	5,13	4,65	4,76	1,16	1,19	0,47	0,61	5,16	5,06	6,88	6,48

1. Removed because of large systematic error obviously due to poor calibration
2. Outlier by Cochran's test
3. Outlier by Grubbs' test

**COMPENDIUM OF INTERNATIONAL ANALYSIS OF METHODS -
OIV
Carbon Dioxide - Manometric Method**

Statistical results of the collaborative test are summarised below.

	Beer	Cide	White wine	Red Wine	Pearl wine	Sparkling wine
		r				
Mean (g/L)	5.145	4.859	1.316	0.532	5.139	6.906
Mean rep. 1 (g/L)	5.156	4.833	1.306	0.510	5.154	6.897
Mean rep 2 (g/L)	5.134	4.885	1.327	0.553	5.124	6.914
s_r (g/L)	0.237	0.089	0.060	0.053	0.086	0.149
s_R (g/L)	0.237	0.139	0.135	0.059	0.124	0.538
SDR_r (%)	4.597	1.821	4.562	9.953	1.663	2.163
RSD_R (%)	4.611	2.855	10.22	11.07	2.407	7.795
r (2,8*s_r) (g/L)	0.662	0.248	0.168	0.148	0.239	0.418
R (2,8*s_R) (g/L)	0.664	0.388	0.377	0.165	0.346	1.507
HORRAT R	1.043	0.640	1.883	1.779	0.544	1.843

Conclusion

The Horrat values are < 2 indicating an acceptable method. The Horrat values are, however, a little bit high. In five of the nine participating laboratories these tests were made almost with no previous experience. Therefore the results can be considered at least as very satisfactory.

The method gives the results in g/L but the results can be converted to pressure units. ¹

1. Troost, G. and Haushofer, H., Sekt, Schaum- und Perlwein, Eugen Ulmer Gmbh & Co., 1980, Klosterneuburg am Rhein, ISBN 3-8001-5804-3, Diagram 1 on the page 13.

Annex C

Validation at low carbon dioxide levels

1. The detection and the determination limit

A sample of white wine was analysed in duplicate ten times. The statistical data was as follows:

Replicates	10
Mean CO ₂ (g/L)	0.41
Standard deviation of the mean, s (g/L)	0.048
Detection limit 3 x s	0.14
Determination limit 6 x s	0.48

2. Standard addition

Standard additions in five different concentrations in duplicates were made into the same wine which was used for the determination of the detection and determination limits. The corresponding concentrations of CO₂ were also added to water. The linear regressions of these two experiments were compared.

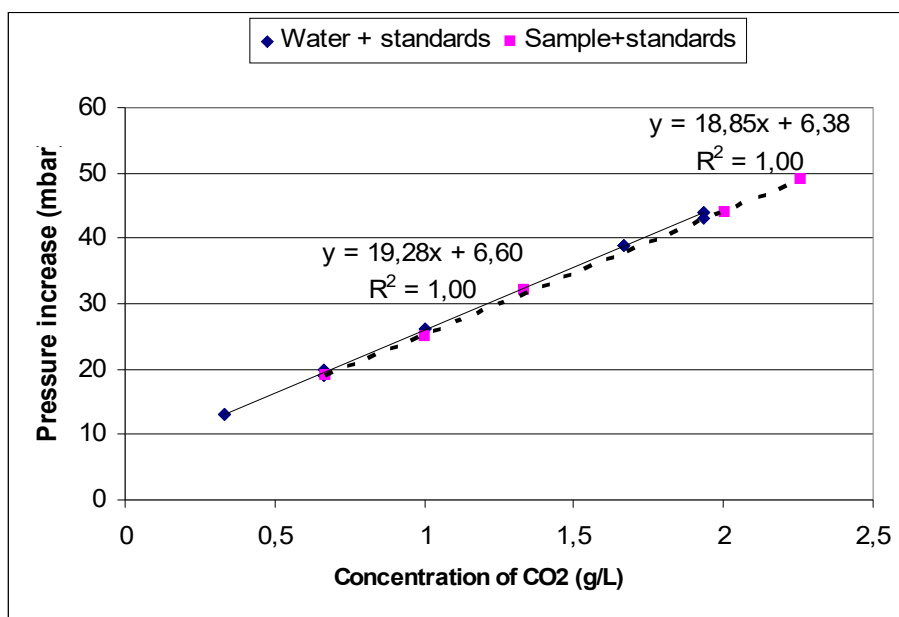

**COMPENDIUM OF INTERNATIONAL ANALYSIS OF METHODS -
OIV
Carbon Dioxide - Manometric Method**

Fig. 1 Standard additions to the sample and to water.

Statistical data of the plots:

	Water+ standards	Sample+standards
Slope	19.3	18.9
Uncertainty of the slope	0.3	0.3
Intercept	6.6	6.4
Uncertainty of the intercept	0.4	0.5
Residual standard deviation	0.4	0.3
number of samples	15	10

According to statistical data the two regression lines are similar.

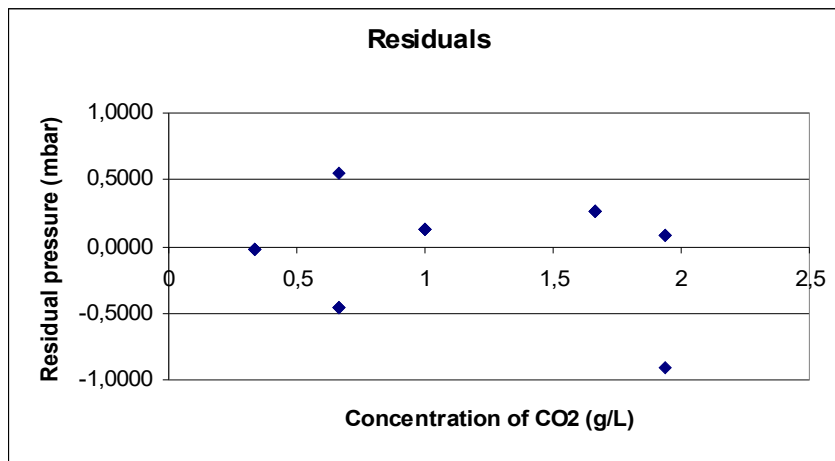

Fig. 2. The residuals of the “water+standards” equation

The residuals are dispatched on both sides of zero indicating that the regression line is linear.

**COMPENDIUM OF INTERNATIONAL ANALYSIS OF METHODS -
OIV
Carbon Dioxide - Manometric Method**

Annex D

Comparison with other techniques and laboratories

1. Comparison of the modified EBC method with the commercial Anton Paar CarboQC instrument

Sample	Modified EBC method (g/L)	Anton Paar CarboQC (g/L)	Difference
Sparkling wine	9,14	9,35	-0,21
Cider	4,20	4,10	0,1
White wine	1,18	1,10	0,08
Red wine	1,08	0,83	0,25
Beer 1	5,26	5,15	0,11
Beer 2	4,89	4,82	0,07
Beer 3	4,90	4,92	-0,02
Non-alcohol Beer 1	5,41	5,33	0,08
Non-alcohol beer 2	5,39	5,36	0,03
			Mean 0.06

According to t-test there is no systematic difference in the measurements.

2. Comparison between Bfr, Germany and ACL, Finland

Bfr sent four samples to ACL, and ACL sent five samples to Bfr. These nine samples were analysed independently both by ACL using the method presented in this paper and in Germany at Bfr using the titrimetric method. Statistics of the results were as follows:

Mean of the difference	0.14 g/L
Std. of the difference	0.13 g/L
Z-score	1.04

The method presented here and the titrimetric method were also compared by Bundesamt für Weinbau in Austria using 21 samples of their own. Statistical data was as follows:

Mean of the difference	-0.01 g/L
Std. of the difference	0.26 g/L
Z-score	-0.03

Conclusion

According to this paper as well as earlier experiments this method is universal. It is suitable for the determination of the carbon dioxide content in all kinds of alcoholic beverages, e.g. beers, wines, fruit wines, ciders, pearl wines and sparkling wines with the concentration level of 0.3 g/L and higher.

***COMPENDIUM
OF INTERNATIONAL
METHODS OF WINE
AND MUST ANALYSIS***

EDITION 2024

VOLUME 2



INCLUDED :

***Resolutions adopted in the 21st General Assembly
9th June 2023 – Jerez (Spain)***

Printed in Dijon (France)

12, Parvis de l'UNESCO

21000 Dijon, France

Legal Deposit : January 2024

ISBN : 978-2-85038-097-6

ISBN Volume II : 978-2-85038-097-6

Acetaldehyde

(A37 revised by OIV/OENO 377/2009)

1. Principle

Acetaldehyde (ethanal) in carbon decolorized wine, reacts with sodium nitroferricyanide and piperidine and causes a green to violet color change whose intensity is measured at 570 nm.

2. Apparatus

Spectrophotometer permitting measurement of absorbance at a wavelength of 570 nm with a 1 cm optical cell path.

3. Reagents

3.1 Piperidine solution, (C₅H₁₁N) 10% (v/v).

Prepare just before use by mixing 2 mL of piperidine with 18 mL of distilled water.

3.2 Sodium nitroferricyanide solution, 0.4% (m/v).

In a 250 mL glass volumetric flask, dissolve 1 g of pulverized sodium nitroferricyanide, Na₂ [Fe(CN)₅ NO].2H₂O in distilled water and make up to volume.

3.3 Activated carbon

3.4 Dilute hydrochloric acid, 25% (v/v)

3.5 Alkaline solution

Dissolve 8.75 g of boric acid in 400 mL sodium hydroxide solution, 1 M. Make up to 1 L with distilled water.

4. Procedure

4.1 Sample

Place approx. 25 mL of wine in a 100 mL Erlenmeyer flask, add 2 g of activated charcoal. Shake vigorously for a few seconds, allow to stand for 2 minutes and filter through a fluted slow filter to obtain a clear filtrate.

**COMPENDIUM OF INTERNATIONAL METHODS OF ANALYSIS -
OIV
Acetaldehyde**

Place 2 mL of the clear filtrate into a 100 mL Erlenmeyer flask, add, while shaking, 5 mL of the sodium nitroferricyanide solution (3.2) and 5 mL of the piperidine solution (3.1). Mix and place the mixture immediately into a 1 cm optical cell. The coloration produced, which varies from green to violet, is measured with reference to air at a wavelength of 570 nm. This color change increases then decreases rapidly; measure immediately and record the maximum value of the absorbance that is obtained after about 50 seconds. The concentration of acetaldehyde in the liquid analyzed is obtained using a calibration curve.

Note: If the liquid analyzed contains excess free acetaldehyde, it will be necessary, before beginning the total acetaldehyde determination, to first combine it with sulfur dioxide. To achieve this, add a small amount of excess free SO₂ to a portion of the liquid to be analyzed and wait for an hour before proceeding.

4.2. Preparation of the calibration curve

4.2.1 Solution of acetaldehyde combined with sulfur dioxide

Prepare a solution of between 5 to 6% (*m/v*) sulfur dioxide and determine the exact strength by titrating with 0.05 M iodine solution.

In a 1 L glass volumetric flask, add a volume of this solution which corresponds to 1500 mg of sulfur dioxide. Introduce into the flask, using a funnel, about 1 mL of acetaldehyde distillate recently distilled and collected in a cooling mixture. Make up to 1 liter with distilled water. Mix and allow to stand overnight.

The exact concentration of this solution is determined as follows:

Place in a 500 mL Erlenmeyer flask, 50 mL of the solution; add 20 mL of dilute hydrochloric acid (3.4) and 100 mL water. Titrate the free sulfur dioxide using a solution of 0.05 M iodine with starch as indicator, stopping at a faint blue end point.

Add 100 mL of the alkaline solution, and the blue coloration will disappear. Titrate the combined sulfur dioxide and acetaldehyde with 0.05 M iodine until a faint blue end point is reached: let *n* be the volume used.

The acetaldehyde solution combined with SO₂ contains 44.05 *n* mg of acetaldehyde per liter.

**COMPENDIUM OF INTERNATIONAL METHODS OF ANALYSIS -
OIV
Acetaldehyde**

4.2.2 Preparation of the calibration standards

In five 100 mL glass volumetric flasks, place respectively 5, 10, 15, 20 and 25 mL of the stock solution. Make up to volume with distilled water. These solutions correspond to acetaldehyde concentrations of 40, 60, 120, 160 and 200 mg/L. The exact concentration of the dilutions must be calculated from the acetaldehyde concentration of the stock solution (4.2.1) previously determined.

Proceed with the determination of acetaldehyde on 2 mL of each of these dilutions as indicated in 4.1. The graph of the absorbance of these solutions as a function of acetaldehyde content is a straight line that does not pass through the origin.

BIBLIOGRAPHY

REBELEIN H., *Dtsch. Lebensmit. Rdsch.*, 1970, **66**, 5-6.

Method OIV-MA-AS315-02A

Type IV method

Ethyl Acetate

(Recueil OIV ed. 1990 revised by OIV/OENO 377/2009)

1. Principle of the methods

Ethyl acetate is determined by gas chromatography on wine distillate using an internal standard.

2. Method

2.1 *Apparatus* (see chapter *Volatile Acidity*).

2.2 *Procedure*

Prepare an internal standard solution of 4-methyl-2-pentanol, 1 g/L, in ethanol solution, 10% (v/v).

Prepare the sample solution to be determined by adding 5 mL of this internal standard solution to 50 mL of wine distillate obtained as indicated in the chapter on *Alcoholic Strength*.

Prepare a reference solution of ethyl acetate, 50 mg/L, in ethanol, 10% (v/v). Add 5 mL of the internal standard to 50 mL of this solution.

Analyze 2 μ L of the sample solution and the reference solution using gas chromatography.

Oven temperature is 90°C and the carrier gas flow rate is 25 mL per minute.

2.3 *Calculation*

S = the peak area of ethyl acetate in the reference solution.

S_x = the peak area of the ethyl acetate in the sample solution.

I = the peak area of the internal standard in the sample solution.

I = the peak area of the internal standard in the reference solution.

The concentration of ethyl acetate, expressed in milligrams per liter, is given by:

COMPENDIUM OF INTERNATIONAL METHODS OF ANALYSIS -
OIV
Ethyl Acetate

$$50 \times \frac{I}{i} \times \frac{S_x}{S}$$

**COMPENDIUM OF INTERNATIONAL METHODS OF ANALYSIS -
OIV
Ethyl Acetate**

Method OIV-MA-AS315-02B

Type IV method

Ethyl Acetate
(OIV/OENO 377/2009)

1. Principle of the methods

Ethyl acetate is separated by distillation of wine brought to pH 6.5. After saponification and suitable concentration in an alkaline environment, the distillate is acidified and the vapor condensed to separate the acetic acid liberated by saponification; the acid portion is titrated with the alkaline solution.

2. Method

2.1 Reagents

- 2.1.1 Sodium hydroxide solution, 1 M
- 2.1.2 pH 6.5 Buffer solution
 - Potassium *di*-hydrogen phosphate, KH_2PO_4 5 g
 - Sodium hydroxide solution 1 M 50 mL
 - Water to 1 L
- 2.1.3 Crystalline tartaric acid
- 2.1.4 Sodium hydroxide solution, 0.02 M
- 2.1.5 Neutral phenolphthalein solution, 1%, in alcohol, 96% (v/v).

2.2 Usual method

Into a 500 mL volumetric flask, place 100 mL of non-decarbonated wine neutralized with n mL of 1 M sodium hydroxide solution, n being the volume of sodium hydroxide solution, 0.1 M, used for measuring the total acidity of 10 mL of wine. Add 50 mL of pH 6.5 buffer solution and distill. The distillation must be conducted using a tapered tube into a 500 mL round-bottom flask containing 5 mL of 1 M sodium hydroxide solution, on which a mark has been made indicating a volume of approximately 35 mL. Collect 30 mL of distillate.

**COMPENDIUM OF INTERNATIONAL METHODS OF ANALYSIS -
OIV
Ethyl Acetate**

Stopper the flask and allow to stand for one hour. Concentrate the contents of the flask to approximately 10 mL by placing it in a boiling water bath and blowing a rapid stream of air into the bowl of the flask. Allow to cool. Add 3 g tartaric acid (2.1.3). Eliminate carbon dioxide by shaking under a vacuum. Transfer the liquid from the concentrating flask to the bubbling chamber of a steam distillation apparatus and rinse the flask twice with 5 mL of water. Steam distill and recover at least 250 mL of distillate.

Titrate with a 0.02 M sodium hydroxide solution, in the presence of phenolphthalein.

2.3 Calculation

Let n be the number of milliliters of sodium hydroxide solution, 0.02 M (2.1.4) used. 1 mL corresponds to 1.76 mg ethyl acetate.

The concentration of ethyl acetate in milligrams per liter is given by:

$$17.6 \times n$$

BIBLIOGRAPHY

Usual method:

PEYNAUD E., *Analyse et contrôle des vins*, Librairie Polytechnique Ch.- Béranger, 1958.

Method OIV-MA-AS315-03

Type IV method

Malvidin diglucoside
(A18 revised by OIV/OENO 377/2009)

1. Principle

Malvidin diglucoside, oxidized by nitric acid, is converted to a substance that, in an ammonium medium, emits a vivid green fluorescence in ultraviolet light.

The intensity of the fluorescence of the compound formed is measured by comparison with the fluorescence of a solution titrated with quinine sulfate whose intensity of fluorescence is standardized with the malvidin diglucoside reference.

Free sulfur dioxide, which attenuates the fluorescence, must previously be combined with excess acetaldehyde.

2. Qualitative Examination

2.1 Apparatus

2.1.1 Ultraviolet lamp permitting measurement at 365 nm.

2.2 Reagents

2.2.1 Acetaldehyde solution

Crystallizable paraldehyde
10 g
Ethanol 96% (v/v) 100 mL

2.2.2 Hydrochloric acid, 1.0 M.

2.2.3 Sodium nitrate solution, 10 g/L.

2.2.4 Ethanol, 96% (v/v), containing 5% concentrated ammonia solution ($r_{20} = 0.92$ g/mL).

2.2.5 Control wine containing 15 mg of malvidin diglucoside per liter.

2.2.6 Wine containing no malvidin diglucoside.

2.3 Method

Into a test tube add:

- 10 mL of wine
- 1.5 mL of acetaldehyde solution

wait 20 minutes.

Into a 20 mL centrifuge tube place:

- 1 mL of wine reacted with acetaldehyde
- 1 drop of hydrochloric acid
- 1 mL sodium nitrate solution

Stir; wait 2 minutes (5 minutes maximum); add:

- 10 mL ammoniacal ethanol

Treat similarly 10 mL of wine containing 15 mg/L malvidin diglucoside (The control wine). Stir. Wait 10 minutes and centrifuge.

Decant the clear liquids from the top into calibrated test tubes. Observe the difference in green fluorescence between the test wine and the control wine under ultraviolet light at 365 nm.

For rose wines, it is possible to increase the sensitivity using:

- 5 mL of wine treated with acetaldehyde (2.3)
- 0.2 mL hydrochloric acid, 1 M (2.2.2)
- 1 mL sodium nitrate solution, 10 g/L (2.2.3)
- 5.8 mL ammoniacal ethanol (2.2.4)

Treat the control wine in a similar manner.

2.4 Interpretation

Wines that do not fluoresce, or have a distinctly lower fluorescence, than the control, may be considered to have no malvidin diglucoside. Those whose fluorescence is slightly less than, equal to, or greater than the control should have a quantitative determination.

3. Quantitative Determination

3.1. Apparatus

3.1.1. Equipment for measuring fluorescence:

- excitation wavelength 365 nm;
- wavelength of fluorescent radiation 490 nm.

3.1.2. Optical quartz cell (1 cm path length)

3.2 Reagents

3.2.1. See qualitative examination

3.2.2. 2 mg/L quinine sulfate solution

Prepare a solution containing 10 mg very pure quinine sulfate in 100 mL sulfuric acid, 0.1 M. Dilute 20 mL of this solution to 1 liter with sulfuric acid solution, 0.1 M.

3.3 Procedure

COMPENDIUM OF INTERNATIONAL METHODS OF ANALYSIS - OIV
Malvidin diglucoside

Treat the wine by the method described in *Qualitative examination (2)*, except that the aliquot of acetaldehyde treated wine is each case (red wines and roses) 1 mL.

Place the 2 mg/L solution of quinine sulfate in the cell, adjust the fluorometer to the full range (transmission T, equal to 100%) by adjusting the slit width or the sensitivity.

Replace this tube with the one containing the test wine: this is the T₁ value.

If the percentage of transmission, T₁ is greater than 35, dilute the wine with wine without malvidin diglucoside whose fluorescence must be less than 6% (this should be ascertained by previous testing.)

Remarks:

1. Salicylic acid (sodium salicylate) added to the wine for stabilization before analysis, causes a spurious fluorescence which can be eliminated by an extraction with ether.
2. Spurious fluorescence is caused by the addition of caramel.

3.4 Calculation

A fluorescence intensity of 1, for wine without SO₂, for the operating conditions above with the exception of the acetaldehyde treatment, corresponds to 0.426 mg malvidin diglucoside per liter of wine.

On the other hand, red and rose wines, containing no malvidin diglucoside, give fluorescence corresponding to a T value of the order of 6%.

The amount of malvidin diglucoside in wine in milligrams per liter is therefore:

$$(T_1 - 6) 0,426 \times \frac{11,5}{10} = (T_1 - 6) \times 0,49$$

If the wine is diluted, multiply the result by the dilution factor.

3.5 Expression of the Results

The amount of malvidin diglucoside is expressed in milligrams per liter of wine to the nearest whole number.

BIBLIOGRAPHY

- DORIER P., VERELLE L., *Ann. Fals. Exp. Chim.*, 1966, **59**, 1.
GAROGGIO P.G., *Rivista Vitic. Enol.*, 1968, **21**, 11.
BIEBER H., *Deutsche Lebensm. Rdsch.*, 1967, 44-46.
CLERMONT MILLE S., SUDRAUD P., *F.V., O.I.V.*, 1976 n° 586.

Ethyl Carbamate

(OENO 8/98 revised by OIV/OENO 377/2009)

Ethyl carbamate analysis in alcoholic beverages: selective detection method by gas chromatography/mass spectrometry (Applicable to the determination of ethyl carbamate concentrations between 10 and 200 µg/l).

(Caution: respect safety measures when handling chemical products, ethanol, acetone and carcinogenic products: ethyl carbamate and dichloromethane. Get rid of used solvents in a suitable way, compatible with applicable environmental rules and regulations).

1. Principle

Propyl carbamate is added to a sample as an internal standard, the solution is diluted with water and placed in a 50 mL solid phase extraction column. Ethyl carbamate and propyl carbamate are eluted with dichloromethane. The eluate is concentrated in a rotary evaporator under vacuum. The concentrate is analyzed by gas chromatography/mass spectrometry using selected ion monitoring mode.

2. Apparatus

2.1 Gas chromatograph/mass spectrometer (GC/MS). With selected ion monitoring (SIM), and data handling system. An autosampler is desirable.

2.2 Capillary fused silica column: 30m* × 0.25 mm Ø int., 0.25 µm of Carbowax 20M type.

2.3 Operating conditions: injector 180°C, helium carrier gas at 1 mL/min at 25°C, splitless injection. Temperature program: 40°C for 0.75 min, then program 10°C/min to 60°C, then 3°C*/min to 150°C, post run: go up to 220°C and maintain for

* For certain wines which are particularly rich, it may be desirable to use a 50m long capillary column.

** For certain wines which are particularly rich, it may be desirable to carry out a temperature program of 2°C per minute.

**COMPENDIUM OF INTERNATIONAL METHODS OF ANALYSIS -
OIV**

Ethyl carbamate

4.25 min at 220°C. The retention time for ethyl carbamate is 23-27 min., that of propyl carbamate is 27-31 min.

GC/MS interface: transfer line 220°C. Mass spectrometer parameters set up manually with perfluorotributylamine and optimized for a lower mass sensitivity, SIM acquisition mode, solvent delay and time for the start of acquisition 22 min., dwell time/ion 100 ms.

- 2.4 Rotary evaporator under vacuum or concentration system similar to Kuderna Danish. (Note: the recovery of the ethyl carbamate test sample, (3.7) must be between 90-110% during the process).
- 2.5 Flask - pear-shaped, 300 mL, single neck, 24/40 standard taper joint.
- 2.6 Concentrator tube - 4 mL, graduated, with a standard taper 19/22 Teflon coated joint and stopper.

3. Reagents

3.1 *Acetone* - HPLC quality. *Note:* Check each batch by GC/MS before use with regard to the absence of response for m/z 62, 74 and 89 ions.

3.2 *Dichloromethane* - *Note:* Analyze each batch before use by GC/MS after 200 fold concentration to check the absence of response for m/z 62, 74 and 89 ions.

3.3 *Ethanol - anhydrous*

3.4 *Ethyl carbamate (EC) standard solutions*

- (1) Stock solution - 1.00 mg/mL. Weigh 100 mg EC ($\geq 99\%$ purity) in a volumetric flask of 100 mL and dilute to mark with acetone.
- (2) Standard working solution- 10.0 $\mu\text{g/mL}$. Transfer 1 mL of the EC stock solution to a 100 mL volumetric flask and dilute with acetone to the mark.

3.5 *n-Propyl carbamate (PC), standard solutions.*

- (1) Stock solution - 1.00 mg/mL. Weigh 100 mg PC (reagent quality) in a 100 mL volumetric flask and dilute with acetone to the mark.
- (2) Standard working solution- 10.0 $\mu\text{g/mL}$. Transfer 1 mL of the PC stock solution to a volumetric flask of 100 mL and dilute with acetone to the mark.

**COMPENDIUM OF INTERNATIONAL METHODS OF ANALYSIS -
OIV**

Ethyl carbamate

- (3) Internal standard solution PC - 400 ng/mL. Transfer 4 mL of the standard PC working solution to a volumetric flask of 100 mL and dilute with water to the mark.

3.6 *EC - nPC standard calibration solutions* - Dilute the standard working solutions of EC, 3.4 (2), and PC 3.5 (2), with dichloromethane in order to obtain:

- (1) 100 ng EC and 400 ng *nPC*/mL,
- (2) 200 ng EC and 400 ng *nPC*/mL,
- (3) 400 ng EC and 400 ng *nPC*/mL,
- (4) 800 ng EC and 400 ng *nPC*/mL,
- (5) 1600 ng EC and 400 ng *nPC*/mL.

3.7 Practice sample - 100 ng EC/mL in 40 % ethanol. Transfer 1 mL of the standard EC working solution, 3.4 (2) in a 100 mL volumetric flask and dilute with 40 % of ethanol to the mark.

3.8 Solid phase extraction column - Disposable material, pre-packed with diatomaceous earth, capacity 50 mL.

(Note: Before analysis, check each batch of extraction columns for the recovery of EC and *nPC* and the absence of response for ions of *m/z* 62,74 and 89.) Prepare 100 ng EC/mL of test sample 3.7.

Analyze 5.00 mL of the test sample as described in 4.1, 4.2, 5, and 6. The recovery of 90-110 ng of EC/mL is satisfactory. Adsorbents whose particle diameter is irregular can lead to a slow flow that affects the recovery of EC and *nPC*.

If, after several trials, 90-110 % of the test sample value is not obtained, change the column or use a corrected calibration recovery curve to quantify EC.

To obtain the corrected calibration curve, prepare standard solutions as described in 3.6 by using 40 % ethanol instead of dichloromethane.

Analyze 1 mL of the standard calibration solution as described in 4, 5, and 6.

Establish a new standardization curve by using the EC/*nPC* ratio of the extracted standards.

4. Preparation of the test sample

Place the test material in 2 separate 100 mL beakers using the following quantities:

4.1 Wines containing over 14 % vol. alcohol: 5.00 mL ± 0.01 mL.

**COMPENDIUM OF INTERNATIONAL METHODS OF ANALYSIS -
OIV
Ethyl carbamate**

4.2 Wines containing maximum 14% vol. of alcohol: 20.00 mL \pm 0.01 mL.

In each beaker, add 1 mL of internal standard PC solution, 3.5 (3) and water, in order to obtain a total volume of 40 mL (or 40 g).

5. Extraction

(Note: Carry out the extraction under a fume hood with adequate ventilation.)

Transfer diluted test portion from **4** to the extraction column.

Rinse the beaker with 10 mL of water and transfer the rinsing water to the column. Let the liquid be absorbed in the column for 4 minutes. Elute with 2 \times 80 mL of dichloromethane.

Collect the eluate in a 300 mL pear-shaped flask.

Evaporate the eluate to 2 to 3 mL in a rotary evaporator in a water bath at 30°C (Note: do not let extract evaporate to dryness).

Transfer the concentrated residue to a 4 mL graduated concentrator tube, with a 9 in Pasteur pipette.

Rinse the flask with 1 mL of dichloromethane and transfer the rinsing liquid to the tube.

Concentrate the sample to 1 mL under a slight nitrogen stream.

If an autosampler is used, transfer the concentrate to a vial for GC/MS analysis.

6. GC/MS Analysis

6.1 *Calibration curve* - Inject 1 μ l of each calibration standard solution 3.6, into GC/MS. Plot the graph of the EC-*n*PC area ratio for the response to m/z 62 ion on the y-axis and the quantity of EC in ng/mL on the x-axis (i.e., 100, 200, 400, 800, 1600 ng/mL).

6.2 *EC quantification* - Inject 1 μ l of concentrated extract from **5** in the GC/MS system and calculate the EC-*n*PC area ratio for m/z 62 ion. Determine the concentration of EC (ng/mL) in the extract by using the internal standard standardization curve. Calculate the EC concentration in the test sample (ng/mL) by dividing the quantity of EC (ng/mL) in the extract by the test sample volume 3.7.

6.3 *Confirmation of EC identity*. Determine if the response for m/z 62, 74 and 89 ions appear at the EC retention time. These responses characteristic respectively of the main fragments

**COMPENDIUM OF INTERNATIONAL METHODS OF ANALYSIS -
OIV
Ethyl carbamate**

(M - C₂H₃·)⁺ and (M - CH₃·)⁺ and molecular ion (M). The presence of EC is confirmed if the relative ratio of these ions does not exceed 20% of the ratios of the EC standard. The extract may need to be further concentrated in order to obtain a sufficient response for the m/z 89 ion.

7. Method performance.

Sample	Mean EC found, ng/g	Recovery of added EC, %	S _F	S _R	RSD _F %	RSD _R %
Wine over 14 % alcohol (v/v)	40		1.59	4.77	4.01	12.02
	80	89	3.32	7.00	4.14	8.74
	162	90	8.20	11.11	5.05	6.84
Wine under 14% alcohol (v/v)	11		0.43	2.03	3.94	18.47
	25	93	1.67	2.67	6.73	10.73
	48	93	1.97	4.25	4.10	8.86

Hydroxymethylfurfural (HMF)

(A19 revised by OIV/OENO 377/2009)

1. Principle of the methods

Aldehydes derived from furan, the main one being hydroxymethylfurfural, react with barbituric acid and para-toluidine to give a red compound which is determined by colorimetry at 550 nm.

Free sulfurous acid interferes with the determination. When its amount exceeds 10 mg/L, it must be previously eliminated by combining it with acetaldehyde whose excess does not interfere with the determination.

2. Colorimetric method

2.1 Apparatus

2.1.1 Spectrophotometer for making measurements between 300 and 700 nm.

2.1.2 Glass cells with optical paths of 1 cm.

2.2 Reagents

2.2.1 Barbituric acid solution, 0.5% (*m/v*)

Dissolve 500 mg of barbituric acid in distilled water by heating slightly over a water bath at 100°C. Make up to 100 mL with distilled water. This solution keeps for about a week.

2.2.2 Para-toluidine solution, 10% (*m/v*).

Place 10 g of para-toluidine in a 100 mL volumetric flask; add 50 mL of *iso*-propanol, CH₃CH(OH)CH₃, and 10 mL of glacial acetic acid, CH₃COOH ($\rho_{20} = 1.05$ g/mL). Make up to 100 mL with *iso*-propanol. This solution should be renewed daily.

2.2.3 Acetaldehyde (ethanal) solution, 1% (*m/v*).

Prepare just before use.

2.2.4 Hydroxymethylfurfural solution, 1 g/L.

**COMPENDIUM OF INTERNATIONAL METHODS OF ANALYSIS -
OIV**

Hydroxymethylfurfural

Prepare dilutions of the above solution to containing 5, 10, 20, 30 and 40 mg hydroxymethylfurfural/L. The 1 g/L solution and its dilutions must be freshly prepared.

**COMPENDIUM OF INTERNATIONAL METHODS OF ANALYSIS -
OIV
Hydroxymethylfurfural**

2.3 Procedure

2.3.1 Preparation of sample

- Free sulfur dioxide less than 10 mg/L:
Perform the analysis on 2 mL of wine or must. If necessary filter the wine or must before analysis.
- Free sulfur dioxide greater than 10 mg/L:
15 mL of the test samples are placed in a 25 mL spherical flask with 2 mL acetaldehyde solution (2.2.3). Stir. Wait 15 minutes. Bring to volume with distilled water. Filter if necessary. Perform the analysis on 2 mL of this solution.

2.3.2 Colorimetric determination

Into each of two 25 mL flasks, *a* and *b*, fitted with ground glass stoppers, place 2 mL of the sample prepared as in 2.3.1. Place in each flask 5 mL of para-toluidine solution (2.2.2); mix. Add 1 mL of distilled water to flask *b* (control) and 1 mL barbituric acid (2.2.1) solution to flask *a*, shake to mix. Transfer the contents of the flasks into spectrophotometer cells with optical paths of 1 cm. Zero the absorbance scale at a wavelength of 550 nm using the contents of flask *b*. Follow the variation in the absorbance of the contents of flask *a*; record the maximum value *A*, which is reached after 2 to 5 minutes.

Samples with hydroxymethylfurfural concentrations above 30 mg/L must be diluted before the analysis.

2.3.3 Preparation of the calibration curve

Place 2 mL of each of the hydroxymethylfurfural solutions of 5, 10, 20, 30 and 40 mg/L into two sets of 25 mL flasks, *a* and *b*, and treat them as described in 2.3.2.

The graph representing the variation of absorbance with the hydroxymethylfurfural concentration in mg/L should be a straight line passing through the origin.

2.4 Expression of results

The hydroxymethylfurfural concentration is obtained by plotting on the calibration curve the absorbance determined on the sample analyzed, taking into account any dilution carried out.

**COMPENDIUM OF INTERNATIONAL METHODS OF ANALYSIS -
OIV
Hydroxymethylfurfural**

The result is expressed in milligrams per liter (mg/L) to one decimal point.

Hydroxymethylfurfural (HMF)
(A19 revised by OIV/OENO 377/2009)

1. Principle of the methods

Separation through a column by reversed-phase chromatography and determination at 280 nm.

Procedures described below are given as examples.

2. High-performance liquid chromatography

2.1 Apparatus

2.1.1 High-performance liquid chromatograph equipped with:

- a loop injector, 5 or 10 μL
- spectrophotometric detector allowing measurement at 280 nm
- column of octadecyl-bonded silica (e.g. Bondapak C₁₈-Corasil, Waters Ass)
- a recorder, preferably an integrator
- Flow rate of mobile phase: 1.5 mL/minute

2.1.2 Membrane filtration system with a pore diameter of 0.45 μm .

2.2 Reagents

2.2.1 Double distilled water

2.2.2 Methanol, distilled or HPLC quality

2.2.3 Acetic acid ($\rho_{20} = 1.05 \text{ g/mL}$)

2.2.4 Mobile phase: water + methanol + acetic acid previously filtered through a 0.45 μm membrane filter, (40 mL + 9 mL + 1 mL)

The mobile phase must be prepared daily and degassed before using.

2.2.5 Hydroxymethylfurfural reference solution, 25 mg/L (m/v)

**COMPENDIUM OF INTERNATIONAL METHODS OF ANALYSIS -
OIV**

Hydroxymethylfurfural

Into a 100 mL volumetric flask, place 25 mg of hydroxymethylfurfural accurately weighed, and bring to volume with methanol. Dilute this solution 1/10 with methanol and filter through a 0.45 µm membrane filter.

If the solution is kept refrigerated in a hermetically sealed brown glass bottle it should keep for two to three months.

**COMPENDIUM OF INTERNATIONAL METHODS OF ANALYSIS -
OIV
Hydroxymethylfurfural**

2.3 Procedure

Inject 5 (or 10) μL of the sample prepared as described above and 5 (or 10) μL of hydroxymethylfurfural reference solution into the chromatograph. Record the chromatogram.

The retention time of hydroxymethylfurfural is about six to seven minutes.

2.4 Expression of the Results

The hydroxymethylfurfural concentration is expressed in milligrams per liter (mg/L) to one decimal point.

Cyanide Derivatives
(OENO 4/94 revised by OIV/OENO 377/2009)

1. Principle

Free and total hydrocyanic acid is liberated by acid hydrolysis and separated by distillation. After reaction with chloramine T and pyridine, the glutamic dialdehyde formed is determined by colorimetry, due to the blue coloration it gives with 1,3-dimethyl barbituric acid.

2. Equipment

- 2.1. Distillation apparatus: Use the distillation apparatus described for the determination of alcohol in wine.
- 2.2. Round-bottomed 500 mL flask with standard taper joint.
- 2.3. Water bath, thermostated at 20° C.
- 2.4. Spectrophotometer permitting the measurement of absorbance at a wavelength of 590 nm.
- 2.5. Glass cuvette or disposable cuvettes for one use only, with 20 mm optical path.

3. Reagents

- 3.1. Phosphoric acid (H₃PO₄) at 25 p. 100 (w/v)
- 3.2. Solution of chloramine T (C₇H₇ ClNNaO₂S.3H₂O) 3% (w/v)
- 3.3. Solution of 1,3-dimethylbarbituric acid: dissolve 3.658 g of 1,3-dimethylbarbituric acid (C₆H₈N₂O₃) in 15 mL of pyridine and 3 mL of hydrochloric acid (ρ₂₀ = 1.19 g/mL) and bring to 50 mL with distilled water.
- 3.4. Potassium cyanide (KCN)
- 3.5. Solution of potassium iodide (KI) 10% (w/v)
- 3.6. Solution of silver nitrate (AgNO₃), 0.1 M

4. Procedure

**COMPENDIUM OF INTERNATIONAL METHODS OF ANALYSIS -
OIV
Cyanide derivatives**

4.1 Distillation:

In the 500 mL round-bottomed flask (2.2), place 25 mL of wine, 50 mL of distilled water, 1 mL of phosphoric acid (3.1) and some glass beads. Immediately place the round-bottomed flask on the distillation apparatus. Collect the distillate through a delivery tube connected to a 50 mL volumetric flask containing 10 mL of water. The volumetric flask is immersed in an iced water bath. Collect 30-35 mL of distillate (a total of about 45 mL of liquid in the volumetric flask). Wash the delivery tube with a few milliliters of distilled water, bring the distillate to 20°C and dilute with distilled water to the mark.

4.2 Measurement:

Place 25 mL of distillate in a 50 mL glass-stoppered Erlenmeyer flask, add 1 mL of chloramine T solution (3.2) and stopper tightly. After exactly 60 seconds, add 3 mL of 1,3-dimethylbarbituric acid solution (3.3), stopper tightly and let stand for 10 minutes. Then measure the absorbance relative to the reference blank (25 mL of distilled water instead of 25 mL of distillate) at a wavelength of 590 nm in cuvettes of 20 mm optical path.

5. Establishing the standard curve

5.1 *Argentimetric titration of potassium cyanide.*

In a 300 mL volumetric flask, dissolve about 0.2 g of KCN (3.4) precisely weighed in 100 mL of distilled water. Add 0.2 mL of potassium iodide solution (3.5) and titrate with the solution of 0.1 M silver nitrate (3.6) until obtaining a stable yellowish color.

In calculating the concentration of KCN in the sample, 1 mL of 0.1 M silver nitrate solution corresponds to 13.2 mg of KCN.

5.2 *Standard Curve.*

5.2.1. Preparation of the standard solutions:

Knowing the KCN concentration determined in accordance with 5.1, prepare a standard solution containing 30 mg/L of hydrocyanic acid (30 mg HCN = 72.3 mg of KCN). Dilute this solution to 1/10.

Introduce 1.0, 2.0, 3.0, 4.0, and 5.0 mL of the diluted standard solution in 100 mL volumetric flasks and bring to the

**COMPENDIUM OF INTERNATIONAL METHODS OF ANALYSIS -
OIV
Cyanide derivatives**

mark with distilled water. The prepared standard solutions correspond to 30, 60, 90, and 150 µg/L of hydrocyanic acid, respectively.

5.2.2. Determination:

Using 25 mL of the solutions, continue as indicated above in 4.1 and 4.2.

The values obtained for the absorbance with these standard solutions, reported according to the corresponding levels of hydrocyanic acid, form a line passing through the origin.

6. Expression of the results

Hydrocyanic acid is expressed in micrograms per liter (µg/L) without decimal.

6.1. Calculation:

Determine the concentration of hydrocyanic acid from the standard curve. If a dilution was done, multiply the result by the dilution factor.

Repeatability (r) and Reproducibility (R)

$$\begin{aligned} \text{White wine: } r &= 3.1 \text{ } \mu\text{g/L} \quad \text{i.e. approximately } 6\% \cdot X_i \\ R &= 12 \text{ } \mu\text{g/L} \quad \text{i.e. approximately } 25\% \cdot X_i \end{aligned}$$

$$\begin{aligned} \text{Red wine: } r &= 6.4 \text{ } \mu\text{g/L} \quad \text{i.e. approximately } 8\% \cdot X_i \\ R &= 23 \text{ } \mu\text{g/L} \quad \text{i.e. approximately } 29\% \cdot X_i \end{aligned}$$

X_i = average concentration of HCN in the wine.

BIBLIOGRAPHY

- 1) JUNGE C., Feuille vert N° 877 (1990)
- 2) ASMUS E. GARSCHLAGEN H., Z Anal. Chem. 138, 413-422 (1953)
- 3) WÜRDIG G., MÜLLER TH., Die Weinwissenschaft 43, 29-37 (1988)

Examination of artificial sweeteners
(A36 revised by OIV/OENO 377/2009)

1. Principle of the methods

Examination of saccharine (benzoic sulfimide), Dulcin (*p*-ethoxyphenylurea), cyclamate (cyclohexylsulfamate) and P-4000 (5-nitro-2-propoxyaniline or 1-propoxy-2-amino-4-nitrobenzene).

After concentration of the wine, the saccharine, Dulcin and P-4000 are extracted in an acid medium with benzene; the cyclamate is extracted from the wine after the benzene extraction using ethyl acetate (the order of extraction is important). The residues after solvent evaporation are submitted to thin layer chromatography.

Saccharine and cyclamate are identified by chromatography on cellulose plates (solvent: acetone-ethyl acetate-ammonium hydroxide), the first the benzene extract, the second in the extract by the ethyl acetate after purification by washing with ether.

These sweeteners are developed by spraying with a solution of benzidine; aniline; cupric acetate, and have the following R_f: 0.29 for cyclamate, 0.46 for saccharine.

The P-4000 and Dulcin from the benzene extract are separated by chromatography on polyamide plates, (solvent: toluene; methanol; glacial acetic acid). These sweeteners are developed by spraying a solution of *p*-dimethylaminobenzaldehyde, and have the following R_f: 0.60 for Dulcin, 0.80 for P-4000.

2. Method

Examination of saccharine, cyclamate, Dulcin and the P-4000.

2.1 Apparatus

2.1.1 Chromatography tank

2.1.2 Micrometry syringes or micropipettes

**COMPENDIUM OF INTERNATIONAL METHODS OF ANALYSIS -
OIV
Artificial sweeteners**

2.1.3 Separator tube 15 mm in diameter and 180 mm long, with a stopcock

2.1.4 Water bath at 100°C

2.1.5 Regulatable oven, able to reach 125°C

2.2 Reagents

2.2.1 Extraction solvent:

- Benzene
- Ethyl acetate

2.2.2 Chromatography solvents:

Mixture No.1:

Acetone 60 parts
Ethyl acetate 30 parts

Ammonium hydroxide ($\rho_{20} = 0.92$ g/mL) 10 parts

Mixture No 2.:

Toluene 90 parts
Methanol 10 parts
Glacial acetic acid ($\rho_{20} = 1.05$ g/mL) 10 parts

2.2.3. Chromatography plates (20 x 20 cm):

- with layer of cellulose powder (for ex., Whatman CC 41 or Macherey-Nagel MN300)
- with layer of polyamide powder (for ex., Merck)

2.2.4 Indicating reagent for saccharine and cyclamate

Prepare:

- alcoholic solution of benzidine at 250 mg in 100 mL ethanol
- saturated solution of cupric acetate, $\text{Cu}(\text{C}_2\text{H}_3\text{O}_2)_2 \cdot \text{H}_2\text{O}$
- freshly distilled aniline

Mix: 15 mL of benzidine solution, 1 mL of aniline and 0.75 mL saturated cupric acetate solution.

This solution must be freshly prepared. It corresponds to the volume required for development of a 20 x 20 cm plate.

2.2.5 Hydrochloric acid 50% (v/v),

2.2.6 Nitric acid solution, 25% (v/v),

**COMPENDIUM OF INTERNATIONAL METHODS OF ANALYSIS -
OIV
Artificial sweeteners**

2.2.7 Indicator reagent for the P-4000 and Dulcin: dissolve 1 g of 1,4-paradimethylaminobenzaldehyde in 50 mL methanol; add 10 mL 25% nitric acid; bring to 100 mL with methanol. Use 15 mL of this reagent for the development of a 20 x 20 cm plate.

2.2.8 Cyclo-hexylsulfamic acid in water-ethanol solution, 0.10 g/100 mL

Dissolve 100 mg of the sodium or calcium salt of cyclo-hexylsulfamic acid in 100 mL of an equal part mixture of water and ethanol.

2.2.9 Saccharine aqueous solution, 0.05 g/100 mL

2.2.10 Dulcin, 0.05 g/100 mL of methanol.

2.2.11 P-4000, 0.05 g/100 mL of methanol.

2.3 Procedure

2.3.1 Extraction

100 mL of wine, placed in a beaker, are rapidly evaporated by boiling until the volume is reduced to 30 mL, while directing a current of cold air to the surface of the flask. Allow to cool. Acidify with 3 mL 50% hydrochloric acid (v/v). Transfer to a 500 mL conical flask with a ground stopper, add 40 mL of benzene and stir with a mechanical stirrer for 30 min. Transfer to a separating funnel to separate the organic phase. If an emulsion is formed, it must be separated by centrifugation. Place the organic phase in a conical flask with a ground glass stopper.

Decant the wine previously extracted with benzene, which corresponds to the lower layer in the separating funnel, into a 500 mL conical flask with a ground stopper containing 40 mL of ethyl acetate. Agitate for 30 minutes and separate the organic phase as before taking care to recover only the organic fraction and not the wine.

On a 100°C water bath, evaporate each extraction solvent in 50-60 mm diameter evaporation dishes, in small amounts while directing a stream of cold air on the surface of the dishes. Continue the evaporation until the residue has a syrupy consistency, stopping before the evaporation is complete.

Re-dissolve the benzene extract residue in the evaporation dish with 0.5 mL ethanol-water (1:1) solution (it is advisable to

**COMPENDIUM OF INTERNATIONAL METHODS OF ANALYSIS -
OIV
Artificial sweeteners**

re-dissolve the residue once with 0.25 mL ethanol-water solution and then to rinse the dish with another portion of 0.25 mL of the same solution). Place the ethanol-water extract into a small tube with a ground stopper (extract B).

The residue of the dish in which the ethyl acetate (containing the cyclamate) has been evaporated, is dissolved with 0.5 mL of water and is poured into a small separator tube. Wash the dish with 10 mL ether and add the ether to the contents of the separator tube. Mix vigorously for 2 minutes and separate the lower layer into a small test tube that contains 0.5 mL ethanol. This comprises a total of 1 mL of ethanol-water solution that contains the possible cyclamate (extract A).

2.3.2 Chromatography

2.3.2.1 Saccharine and cyclamate

For examination of the saccharine and cyclamate, use a cellulose plate, with half of the plate for the identification of cyclamate and the other half for saccharine.

To do this, spot 5 to 10 μL of extract A and 5 μL of the standard cyclamate solution. On the second part of the plate spot 5 to 10 μL of extract B and 5 μL of the standard saccharine solution. Place the prepared plate in the chromatography bath containing solvent No.1 (acetone; ethyl acetate; ammonium hydroxide); allow to migrate until the solvent front reaches 10 to 12 cm. Remove the plate from the bath and dry with warm air. Spray the plate evenly and gently with the benzidine reagent (17-18 mL for each plate). Dry the plate with cold air. Place the plate in an oven maintained at 120-125°C for 3 minutes. The spots appear dark gray on a light chestnut background; they turn brownish with time.

2.3.2.2 *P-4000 and Dulcin*

Deposit 5 μL of extract B and 5 μL of the standard solutions of Dulcin and P-4000 on a polyamide plate. Place the prepared plate in the chromatography tank containing solvent No. 2 (toluene; methanol; acetic acid). Let the solvent front reach a height of 10 to 12 cm.

Remove the plate from the tank; dry in cold air. Spray with 15 mL of the *p*-dimethylaminobenzaldehyde reagent, then dry with cold air until the orange-yellow colored spots appear which correspond to Dulcin and P-4000.

**COMPENDIUM OF INTERNATIONAL METHODS OF ANALYSIS -
OIV
Artificial sweeteners**

2.3.2.3 *Sensitivity*

The benzidine reagent allows detection of spots corresponding to 2 µg of saccharine and 5 µg of cyclamate. The *p*-dimethylaminobenzaldehyde reagent reveals 0.3 µg of Dulcin and 0.5 µg of P-4000.

This method allows determination of (depending upon the efficiency of the extractions):

Saccharine	2-3 mg/L
Cyclamate	40-50 mg/L
DULCIN	1 mg/L
P-4000	1-1.5 mg/L

BIBLIOGRAPHY

- TERCERO C., *F.V., O.I.V.*, 1968, n° 277 and *F.V., O.I.V.*, 1970, n° 352.
- Wine Analysis Commission of the Federal Health Department of Germany, 1969, *F.V., O.I.V.*, n° 316.
- International Federation of Fruit Juice Manufacturers, 1972, *F.V., O.I.V.*, n° 40.
- SALO T., ALRO E. and SALMINEN K., *Z. Lebensmittel Unters. u. Forschung*, 1964, **125**, 20.

Examination of artificial sweeteners
(A36 revised by OIV/OENO 377/2009)

1. Principle of the methods

Examination of saccharine, Dulcin and cyclamate.

These sweeteners are extracted from wine using a liquid ion exchanger, then re-extracted with dilute ammonia hydroxide, and are separated by thin layer chromatography using a mixture of cellulose powder and polyamide powder (solvent: xylene; *n*-propanol; glacial acetic acid; formic acid). These sweeteners have a blue fluorescence on a yellow background under ultraviolet light after spraying with a 2,7-dichlorofluorescein solution.

Subsequent spraying with 1,4-dimethylaminobenzaldehyde solution allows differentiation of Dulcin, which gives only one orange spot, from vanillin and the esters of *p*hydroxybenzoic acid which migrate with the same R_f.

2. Method

Examination of saccharine, cyclamate and Dulcin.

2.1 Apparatus

2.1.1 Apparatus for expression by thin layer

2.1.2 Glass plate 20 x 20 cm

Preparation of the plates: mix thoroughly 9 g of dry cellulose powder and 6 g of polyamide powder. Add, while stirring, 60 mL methanol. Spread on the plates to a thickness of 0.25 mm. Dry for 10 minutes at 70°C. The quantities prepared are sufficient for the preparation of 5 plates.

2.1.3 Water bath with a temperature regulator or a rotary evaporator,

2.1.4 UV lamp for examination of the chromatography plates.

**COMPENDIUM OF INTERNATIONAL METHODS OF ANALYSIS -
OIV
Artificial sweeteners**

2.2 Reagents

2.2.1 Petroleum ether (40-60°)

2.2.2 Ion exchange resin, for example: Amberlite LA-2

2.2.3 Acetic acid diluted to 20% (v/v)

2.2.4 Ion exchange solution: 5 mL of ion exchanger is vigorously agitated with 95 mL petroleum ether and 20 mL of 20% acetic acid. Use the upper phase.

2.2.5 Nitric acid in solution, 1 M

2.2.6 Sulfuric acid, 10 % (v/v)

2.2.7 Ammonium hydroxide diluted to 25% (v/v)

2.2.8 Polyamide powder, for example: Macherey-Nagel or Merck

2.2.9 Cellulose powder, for example: Macherey-Nagel MN 300 AC

2.2.10 Solvent for chromatography:

Xylene	45 parts
<i>n</i> -Propanol	6 parts
Glacial acetic acid ($\rho_{20} = 1.05$ g/mL)	7 parts
Formic acid 98-100%	2 parts

2.2.11 Developers:

- solution of 2,7-dichlorofluorescein, 0.2 % (m/v), in ethanol,

- solution of 1,4-dimethylaminobenzaldehyde: dissolve 1 g of dimethylamino-benzaldehyde placed in a 100 mL volumetric flask with about 50 mL ethanol. Add 10 mL of nitric acid, 25% (v/v), and bring to volume with ethanol.

2.2.12 Standard solution:

- solution of Dulcin, 0.1 % (m/v), in methanol,

- solution of saccharine at 0.1 g per 100 mL in a mixture of equal parts methanol and water,

- cyclamate solution: solution containing 1 g of the sodium or calcium salt of cyclohexylsulfamic acid in 100 mL of a mixture of equal parts methanol and water,

- solution of vanillin at 1 g /100 mL in a mixture of equal parts methanol and water,

- solution of the ester of *p*-hydroxybenzoic acid at 1 g /100 mL in methanol.

**COMPENDIUM OF INTERNATIONAL METHODS OF ANALYSIS -
OIV
Artificial sweeteners**

2.3 Procedure:

50 mL of wine is placed in a separatory funnel, acidified with 10 mL dilute sulfuric acid (2.2.6) and extracted with two aliquots of the ion exchange solution using 25 mL each time. The 50 mL of ion exchange solution is washed three times using 50 mL of distilled water each time, which is discarded, then three times with 15 mL of dilute ammonium hydroxide (2.2.7). The ammonia solutions recovered are then carefully evaporated at 50°C until dry on a water bath or in a rotary evaporator. The residue is recovered with 5 mL of acetone and 2 drops 1 M nitric acid solution, filtered, and again evaporated dry at 70°C on a water bath. It is necessary to avoid heating for too long and above 70°C. The residue is recovered with 1 mL of methanol.

5 to 10 µL of this solution and 2 µL of the standard solutions are spotted on the plate. Let the solvent migrate (xylene: *n*-propanol: acetic acid: formic acid) (2.2.10) to a height of about 15 cm, which takes about 1 hour.

After air-drying, the dichlorofluorescein solution is thoroughly sprayed on the plate. The saccharine and the cyclamate appear immediately as light spots on a salmon colored background. Under examination in ultraviolet light (254 or 360 nm), the three sweeteners appear as a fluorescent blue on a yellow background.

The sweeteners separate, from the bottom to the top of the plate, in the following order: cyclamate, saccharine, Dulcin.

The vanillin and the esters of *p*-hydroxybenzoic acid migrate with the same R_f as the Dulcin. To identify Dulcin in the presence of these substances, the plate then must be sprayed with a solution of dimethylaminobenzaldehyde. The Dulcin appears as an orange spot, whereas the other substances do not react.

Sensitivity - The quantity limitation shown on the chromatography plate is 5 µg for the three substances. This method permits detection of:

- Saccharin 10 mg/L
- Cyclamate 50 mg/L
- Dulcin 10 mg/L

BIBLIOGRAPHY

- TERCERO C., *F.V., O.I.V.*, 1968, n° 277 and *F.V., O.I.V.*, 1970, n° 352.
- Wine Analysis Commission of the Federal Health Department of Germany, 1969, *F.V., O.I.V.*, n° 316.
- International Federation of Fruit Juice Manufacturers, 1972, *F.V., O.I.V.*, n° 40.
- SALO T., ALRO E. and SALMINEN K., *Z. Lebensmittel Unters. u. Forschung*, 1964, **125**, 20.

Examination of artificial colorants (A43 revised by OIV/OENO 377/2009)

1. Principle

The wine is concentrated to 1/3 its original volume, made alkaline with a solution of dilute sodium hydroxide and extracted with ether. The ether phase, after being washed with water, is extracted with a dilute acetic acid solution; this acetic solution, alkalinized with ammonia, is brought to boiling in the presence of a piece of wool thread treated with aluminum sulfate and potassium tartrate. The colorant, if any, is fixed on the wool. The wool on which it is fixed is then placed in a dilute acetic acid solution. After evaporation of the acetic solution, the residue is recovered with a water-alcohol solution and analyzed by thin layer chromatography for characterization of the colorant.

The aqueous phase remaining after the ether extraction contains the acid colorants that may be present. They are extracted by using their affinity for animal fibers that markedly absorb the color: they are fixed on a wool plug in a mineral acid medium.

To concentrate the coloring material, carry out a double fixation and/or several successive fixations on increasingly smaller wool plugs.

Coloring of the wool plug indicates that an artificial colorant was added to the wine; the colorant is then identified by thin layer chromatography.

2. Apparatus

- 2.1 20 x 20 glass plates covered with cellulose powder,
- 2.2 Chromatography tank

3. Reagents

- 3.1 Ethyl ether
- 3.2 Sodium hydroxide solution, 5% (*m/v*)
- 3.3 Glacial acetic acid ($\rho_{20} = 1.05$ g/mL)
- 3.4 Dilute acetic acid, containing one part glacial acetic acid to 18 parts water

**COMPENDIUM OF INTERNATIONAL METHODS OF ANALYSIS -
OIV**

Artificial colorants

3.5 Dilute hydrochloric acid: to one part hydrochloric acid ($\rho_{20} = 1.19$ g/mL), add 10 parts distilled water

3.6 Ammonium hydroxide ($\rho_{20} = 0.92$ g/mL)

3.7 White wool threads, previously washed, degreased with ether and dried

3.8 White wool threads, previously washed, degreased with ether, dried and acidified

Acidulant: Dissolve 1 g crystallized aluminum sulfate $\text{Al}_2(\text{SO}_4) \cdot 18\text{H}_2\text{O}$ and 1.2 g acid potassium tartrate in 500 mL water. Place 10 g of the white wool threads, previously washed, degreased with ether and dried in the solution and stir about 1 hour. Let stand 2 to 3 hours; drain, let dry at room temperature.

3.9 Solvent No.1 for chromatography of colorants with basic characteristics:

<i>n</i> -Butanol	50 mL
Ethanol	25 mL
Acetic acid ($\rho_{20} = 1.05$ g/mL)	10 mL
Distilled water	25 mL

3.10 Solvent No.2 for chromatography of colorants with acidic characteristics:

<i>n</i> -Butanol	50 mL
Ethanol	25 mL
Ammonium hydroxide ($\rho_{20} = 0.92$ g/mL)	10 mL
Distilled water	25 mL

4. Procedure

4.1 *Examination of colorants with basic characteristics.*

4.1.1 Extraction of the coloring materials.

Place 200 mL of wine in a 500 mL glass conical flask and boil until reduced to 1/3 its volume.

After cooling, neutralize with 5% sodium hydroxide solution until the natural color of wine shows a marked change.

Extract twice using 30 mL ether. The ether phases are recovered, containing basic colorants to be determined; the extraction residue must be saved for the analysis of acidic colorants.

Wash the extracted ether twice with 5 mL of water to eliminate the sodium hydroxide; mix with 5 mL dilute acetic

**COMPENDIUM OF INTERNATIONAL METHODS OF ANALYSIS -
OIV
Artificial colorants**

acid. The acidic aqueous phase obtained is colored in the presence of a basic colorant.

The presence of the colorant may be confirmed by fixation on acidified wool. Make the acidic aqueous phase obtained alkaline using 5% ammonia. Add 0.5 g acidified wool and boil for about 1 minute. Rinse the wool under running water. If the wool is colored, the wine contains some basic colorant.

4.1.2 Characterization by thin-layer chromatography.

The aqueous acetic phase containing the basic colorant is concentrated to 0.5 mL. If the colorant is fixed on the acidic wool, the wool plug is treated by boiling with 10 mL distilled water and a few drops of acetic acid ($\rho_{20} = 1.05$ g/mL). Remove the wool fragment after wringing out liquid. Concentrate the solution to 0.5 mL.

Deposit 20 μ L of this concentrated solution on the cellulose plate 3 cm from the lateral edge and 2 cm from the lower edge of the plate.

Place the plate in the tank containing solvent No.1 so that the lower edge is immersed in the solvent to a depth of 1 cm.

When the solvent front has migrated to a height of 15 to 20 cm, remove the plate from the tank. Allow to air dry.

Identify the colorant by means of a solution of known artificial colorants of basic characteristics deposited simultaneously on the chromatogram.

4.2 *Examination of colorants with acidic characteristics*

4.2.1 Extraction of the coloring material.

Use the residue from the wine used for examining colorants with basic characteristics, concentrated to 1/3 and neutralized after extraction with ether.

If the first part of the procedure has not been conducted, start with 200 mL wine, place in a conical flask, boil until reduced to 1/3.

In either case, add 3 mL of dilute hydrochloric acid and 0.5 g of white wool: boil for 5 minutes, decant the liquid and wash the wool under running water.

In the conical flask which contains the wool, add 100 mL water and 2 mL dilute hydrochloric acid; boil for 5 minutes, separate the acidic liquid and repeat this procedure until the liquid used to wash is colorless.

**COMPENDIUM OF INTERNATIONAL METHODS OF ANALYSIS -
OIV
Artificial colorants**

After the wool has been thoroughly washed to eliminate the acid completely, recover in a conical flask with 50 mL distilled water and a few drops of ammonium hydroxide ($\rho_{20} = 0.92$ g/mL): bring to a gentle boil for 10 minutes in order to dissolve any artificial coloring matter fixed on the wool.

Remove the wool from the flask, bring the liquid volume to 100 mL and boil until the ammonia completely evaporates. Acidify with 2 mL of dilute hydrochloric acid (check that the reaction of the liquid is definitely acidic by placing 1 drop of this liquid on indicator paper).

Add to the flask 60 mg (about 20 cm of standard thread) of white wool and boil for 5 minutes; remove the wool and rinse it under running water.

If, after this procedure, the wool is colored red, when it involves red wine, or yellow if it pertains to white wine, the presence of artificial organic coloring matter of an acidic nature is proven.

If the color is weak or uncertain, repeat the ammonia treatment and do a second fixation using a 30 mg wool thread.

If, during the course of the second fixation a weak but distinct pink color is obtained, assume the presence of an acidic colorant.

If necessary for a more definite determination, carry out new fixations-elutions (up to 4 or 5) using a procedure identical to that used for the second fixation until a faint but distinct pink color is obtained.

4.2.2 Characterization by thin layer chromatography.

The plug of colored wool is treated by boiling with 10 mL distilled water and few drops of ammonium hydroxide ($\rho_{20} = 0.92$ g/mL). Recover the piece of wool after wringing. Concentrate the ammonium hydroxide solution to 0.5 mL.

Deposit 20 μ L of this solution on a cellulose plate to within 3 cm of the lateral edge and 2 cm of the lower edge of the plate.

Put the plate in place in the tank so that the lower edge is immersed in the solvent to a depth of 1 cm.

When the solvent front has migrated to a height of 15 to 20 cm, remove the plate from the tank and let dry in the air.

**COMPENDIUM OF INTERNATIONAL METHODS OF ANALYSIS -
OIV**

Artificial colorants

Identify the colorant by means of known artificial coloring solutions deposited simultaneously on the chromatogram.

BIBLIOGRAPHY

TERCERO C., *F.V., O.I.V.*, 1970, n° 356.

ARATA P., SAENZ-LASCANO-RUIZ, Mme I., *F.V., O.I.V.*, 1967, n° 229.

Diethylene glycol

(2-hydroxy-ethoxyethanol)

(Recueil OIV ed.1990 revised by OIV/OENO 377/2009)

1. Objective

The detection of diethylene glycol, HOCH₂CH₂OCH₂CH₂OH, in wine where its concentration is equal to or greater than 10 mg/L.

2. Principle

Separation of diethylene glycol from other constituents in wine by gas chromatography using a capillary column, after extraction with ether.

Note: The operating conditions described below are provided as an example.

3. Apparatus

3.1 Gas chromatograph equipped with:

- split-splitless injector,
- flame ionization detector,
- capillary column coated with a film of polyethyleneglycol (Carbowax 20 M), 50 m x 0.32 mm I.D.

Operating conditions:

Injector temperature: 280°C.

Detector temperature: 270°C.

Carrier gas: hydrogen.

Flow rate of carrier gas: 2 mL/min.

Flow rate: 30 mL/min.

Injection: splitless.

Injection volume: 2 µL.

Injection 35°C - flow closed after 40 seconds.

Temperature program: 120°C to 170°C at 3°C/min.

3.2 Centrifuge

4. Reagents

4.1 1,3-propanediol, 1 g/L, in alcohol, 20% (v/v), (internal standard).

**COMPENDIUM OF INTERNATIONAL METHODS OF ANALYSIS -
OIV
Diethylene glycol**

4.2 Aqueous solution of diethyleneglycol 20 mg/L.

5. Procedure

Into a 50 mL flask, place:

- 10 mL of wine
- 1 mL of 1,3-propanediol solution
- 25 mL diethyl ether.

Shake and add sufficient quantity of neutral potassium carbonate to saturate the mixture. Shake. Separate the two phases by centrifugation.

Carry out a second extraction. Eliminate the diethyl ether by evaporation and recover the residue with 5 mL ethanol.

The yield of the extraction must be at least 90%.

Carry out the chromatography according to the conditions given in 3.1.

6. Results

The diethylene glycol is identified by comparing its retention time to the time of the reference solution, analyzed under the same conditions as the wine.

The amount is determined by comparison to the reference solution using the internal standard method.

It is recommended, if the concentration is equal to or less than 20 mg/l, to confirm the presence by mass spectrometry.

BIBLIOGRAPHY

BANDION F., VALENTA M. & KOHLMANN H., *Mitt. Klosterneuburg, Rebe und Wein*, 1985, **35**, 89.

BERTRAND A., *Conn. vigne vins*, 1985, **19**, 191.

**COMPENDIUM OF INTERNATIONAL METHODS OF ANALYSIS -
OIV**

Diethylene glycol

Laboratoire de la répression des fraudes et du contrôle de la
qualité de Montpellier, *F.V., O.I.V.*, 1986, n° 807.

**Measuring ochratoxine A in wine
after going through an immunoaffinity column
and HPLC with fluorescence detection**

OENO 16/2001

OIV-OENO 349-2011

1. FIELD OF APPLICATION

This document describes the method used for determining ochratoxine A (OTA) in red, rosé, and white wines, including special wines, in concentrations ranging up to 10 µg/l using an immunoaffinity column and high performance liquid chromatography (HPLC) [1].

This method was validated following an international joint study in which OTAs were measured in white and red wines during the analysis of naturally contaminated wines and wines with toxins ranging from 0.01 µg/l to 3.00 µg/l.

This method can apply to semi-sparkling wines and sparkling wines as long as the samples have been degassed beforehand, through sonication, for example.

2. PRINCIPLE

Wine samples are diluted with a solution containing polyethylene glycol and sodium hydrogen carbonate. This solution is filtered and purified on the immunoaffinity column.

OTA is eluted with methanol and quantified by HPLC in inverse state with fluorimetric detection.

3. REAGENTS

3.1 Reagents for separation of the OTA on an immunoaffinity column

The reagents listed below are examples. Suppliers of immunoaffinity columns may offer dilution solutions and eluents suitable for their products. If so, it is preferable to use these products.

3.1.1 Sodium hydrogen phosphate dihydrate ($\text{Na}_2\text{HPO}_4 \cdot 2\text{H}_2\text{O}$) CAS [10028-24-7]

3.1.2 Sodium dihydrogen phosphate monohydrate ($\text{NaH}_2\text{PO}_4 \cdot \text{H}_2\text{O}$) CAS [10049-21-5]

3.1.3 Sodium chloride (NaCl) CAS [7647-14-5]

3.1.4 Purified water for laboratories, for example EN ISO 3696 quality (water for analytical laboratory use – Specification and test method [ISO 3696:1987]).

3.1.5 Phosphate buffer (dilution solution)

Dissolve 60g of Na₂HPO₄·2H₂O (3.1.1) and 8.8g of NaH₂PO₄·H₂O (3.1.2) in 950ml of water and add more water to make up to 1 litre.

3.1.6 Phosphate buffer saline (washing solution)

Dissolve 2.85g of Na₂HPO₄·2H₂O (3.1.1), 0.55g of NaH₂PO₄·H₂O (3.1.2) and 8.7g of NaCl in 950ml of water and add more water to make up to 1 litre.

3.1.7 Methanol (CH₃OH) CAS [67-56-1]

3.2 Reagents for HPLC

3.2.1 Acetonitrile for HPLC (CH₃CN) CAS [75-05-8]

3.2.2 Glacial acetic acid (CH₃COOH) CAS [64-19-7]

3.2.3 Mobile phase: water: acetonitrile: glacial acetic acid, 99:99:2, v/v/v

Mix 990 ml of water with 990 ml of acetonitrile (3.2.2) and 20 ml of glacial acetic acid (3.2.3). In the presence of undissolved components, filter through a 0.45µm filter. Degas (with helium, for example) unless the HPLC equipment used includes a degassing step.

3.3 Reagents for the preparation of the OTA stock solution

3.3.1 Toluene (C₆H₅CH₃) CAS [108-88-3]

3.3.2 Mixture of solvents (toluene: glacial acetic acid, 99:1, v/v).

Mix 99 parts in volume of toluene (3.3.1) with one part volume of glacial acetic acid (3.2.2).

3.4 OTA stock solution

Dissolve 1 mg of OTA or the same content in a bulb, if the OTA was obtained in the form of film after evaporation, in the solvent mixture (3.12) to obtain a solution containing approximately 20 to 30 µg/ml of OTA.

To determine the exact concentration, record the absorption spectrum between 300 and 370 nm in a quartz space with 1 cm of optical path while using the solvent mixture (3.12) as a blank. Identify maximum absorption and calculate the concentration of OTA (*c*) in µg/ml by using the following equation:

$$c = A_{\max} \times M \times 100 / \epsilon \times \delta$$

In which:

A_{\max} = Absorption determined by the longest maximum wave (about 333 nm)

M = OTA molecular mass = 403,8 g/mole

ϵ = coefficient d'extinction molaire de l'OTA dans le mélange de solvant (3.12) (ϵ = 544/mole)

δ = optical pathway (cm)

This solution is stable at -18°C for at least 4 years.

3.5 Standard OTA solution (2 µg/ml in toluene: acetic acid, 99:1, v/v)

Dilute the stock solution (3.13) with the solvent mixture (3.12) to obtain a standard solution of OTA with a concentration of 2 µg/ml.

This solution can be stored at + 4 °C in a refrigerator. The stability should be tested regularly.

4. EQUIPMENT

Usual laboratory equipment and in particular, the following equipment:

4.1 Glass tubes (4 ml)

4.2 Vacuum pump to prepare the immunoaffinity columns.

4.3 Reservoir and flow tube adapted to immunoaffinity columns.

4.4 Fibre glass filters (for example Whatman GF/A).

4.5 Immunoaffinity columns specifically for OTA.

The column should have the total link capacity of at least 100 ng OTA. This will allow for a purification yield of at least 85% when a diluted solution of wine containing 100 ng OTA is passed through.

4.6 Rotating evaporator

4.7 Liquid chromatography, a pump capable of attaining a constant flow of 1 ml/mn isocratic, as with the mobile phase.

4.8 Injection system must be equipped with 100 µl loop.

4.9 Column of analytical HPLC in steel 150 × 4.6 mm (i.d.) filled with a stationary phase C_{18} (5 µm) preceded with a pre-column or a pre-filter (0,5 µm) containing an appropriate phase. Different size columns can be used provided that they guarantee a good base line and background noise enabling the detection of of OTA peaks, among others.

4.10 Fluorescence detector is connected to the column and the excitation

wavelength is set at 333 nm and the emitting wavelength at 460 nm.

4.11 Information retrieval system

4.12 U.V. spectrometer

5. PROCEDURE

5.1 Preparation of samples

Pour 10 ml of wine in a 100 ml conical flask. Add 10 ml of the dilution solution (3.8). Mix vigorously. Filter through fibreglass filter (4.4). Filtration is necessary for cloudy solutions or when there is precipitation after dissolving.

5.2 Purification by immunoaffinity column

Set up the by immunoaffinity column (4.5) to the vacuum pump (4.2), and attach the reservoir (4.3).

Add 10 ml (equivalent to 5 ml of wine) of the diluted solution in the reservoir. Put this solution through the immunoaffinity column at a flow of 1 drop per second. The immunoaffinity column should not become dry. Wash the immunoaffinity column with 5 ml of cleaning solution (3.9) and then with 5 ml of water at a flow of 1 to 2 drops per second.

Blow air through to dry column. Elute OTA in a glass flask (4.1) with 2 ml of methanol (3.4) at the rate of 1 drop per second. Evaporate the eluate to dryness at 50° C with nitrogen. Dissolve again immediately in 250 µl of the HPLC mobile phase (3.10) and keep at 4° C until the HPLC analysis.

5.3 HPLC analysis

Using the injection loop, inject 100 µl of reconstituted extract (equivalent to 2 ml of wine) in the chromatography.

Operating conditions

Flow: 1 ml /min.

Mobile phase: acetonitrile: water: glacial acetic acid (99:99:2, v/v/v)

Fluorescence detector: Excitation wavelength = 333 nm

Emitting wavelength = 460 nm

Volume of injection: 100 µl

6. QUANTIFICATION OF OCHRATOXINE A (OTA)

The quantification of OTA should be calculated by measuring the area or the height of the peaks at the OTA retention time and compared to the calibration curve

**COMPENDIUM OF INTERNATIONAL METHODS OF ANALYSIS - OIV
Ochratoxin A**

6.1 Calibration curve

Prepare a calibration curve daily and every time chromatographical conditions change. Measure out 0.5 ml of the standard OTA solution (3.14) at 2 µg/ml in a glass flask and evaporate the solvent using nitrogen.

Dissolve again in 10 ml in the HPLC mobile phase (3.10) which was previously filtered using a 0.45 µm filter. This produces an OTA of 100 ng/ml solution.

Prepare 5 HPLC calibration solutions in five 5 ml graduated flasks following Table 1.

Complete each 5 ml standard solution with HPLC mobile phase. (3.10).

Inject 100 µl of each solution in the HPLC.

Table 1

	Std 1	Std 2	Std 3	Std 4	Std 5
µl of mobile phase filtered HPLC (3.10)	4970	4900	4700	4000	2000
µl of OTA solution at 100 ng/ml:	30	100	300	1000	3000
OTA concentration (ng/ml)	0.6	2.0	6.0	20	60
Injected OTA (ng)	0.06	0.20	0.60	2.00	6.00

NOTE:

1. If the quantity of OTA in the samples is outside the calibration range, an appropriate dilution should occur or smaller volumes should be injected. In these cases, the final (7) should be reviewed on a case by case basis.

2. Due to the great variations in concentrations, it is recommended to pass the linear calibration by zero in order to obtain an exact quantification for low concentrations of OTA. (less than 0.1 µg/l)

7. CALCULATIONS

Calculate the quantity of OTA in the aliquot of the solution testes and injected in the HPLC column.

Calculate the concentration of OTA (C_{OTA}) in ng/ml (equivalent to µg/l) by using the following formula:

$$C_{OTA} = M_A \times F/V_1 \times V_3/V_2$$

Where:

M_A is the volume of ochratoxin A (in ng) in the aliquot part of the template injected on the column and evaluated from the calibration curve.

**COMPENDIUM OF INTERNATIONAL METHODS OF ANALYSIS - OIV
Ochratoxin A**

F is the dilution factor

V₁ is the sample volume to be analysed (10 ml)

V₂ the volume of the solution tested and injected in the column (100 µl)

V₃ is the volume of solution used to dissolve the dry eluate (250 µl)

8. PERFORMANCES USING THIS METHOD IN LABORATORIES

Table 2 regroups performances of the method applied to white, rosé and red wines in laboratories participating in the validation of this method.

Table 2. Recovery of ochratoxin A from wines overweighted with different concentrations of added ochratoxin A

Addition (µg/l)	Red wine		Rosé wine		White wine	
	Yield ± SD* (%)	RSD# (%)	Yield ± SD* (%)	RSD# (%)	Yield ± SD* (%)	RSD# (%)
0.04	96.7 ± 2.2	2.3	94.1 ± 6.1	6.5	91.6 ± 8.9	9.7
0.1	90.8 ± 2.6	2.9	89.9 ± 1.0	1.1	88.4 ± 0.2	0.2
0.2	91.3 ± 0.6	0.7	88.9 ± 2.1	2.4	95.1 ± 2.4	2.5
0.5	92.3 ± 0.4	0.5	91.6 ± 0.4	0.4	93.0 ± 0.2	0.2
1.0	97.8 ± 2.6	2.6	100.6 ± .,5	2.5	100.7 ± 1.0	1.0
2.0	96.5 ± 1.6	1.7	98.6 ± 1.8	1.8	98.0 ± 1.5	1.5
5.0	88.1 ± 1.3	1.5	-	-	-	-
10,0	88,9 ± 0,6	0,7	-	-	-	-
Average of averages	92.8 ± 3.5	3.8	94.5 ± 5.2	5.5	94.5 ± 4.1	4.3

* SD = Spread type (Standard deviation) (n = 3 replicates) ;

RSD = Relative spread type (Variation percentage).

9. GROUP WORK

The method was validated by a group study with the participation of 16 laboratories in 8 countries, following the protocol recommendations harmonised for validating the analysis methods. [2]. Each participant analysed 10 white wines, 10 red wines, representing 5 random duplicate wines; naturally contaminated or with OTA added. The performances of the method which resulted from this work

are found in appendixes I and II, outlining critical points of the method are found in appendix III.

10. PARTICIPATING LABORATORIES

Unione Italiana Vini, Verona	ITALY
Istituto Sperimentale per l'Enologia, Asti	ITALY
Istituto Tecnico Agraria, S. Michele all'Adige (TN)	ITALY
Università Cattolica, Piacenza	ITALY
Institute for Health and Consumer Protection, JRC – Ispra	ITALY
Neutron s.r.l., S. Maria di Mugnano (MO)	ITALY
Chemical Control s.r.l., Madonna dell'Olmo (CN)	ITALY
Laboratoire Toxicologie Hygiène Appliquée, Université V. Segalen, Bordeaux	FRANCE
Laboratoire de la D.G.C.C.R.F. de Bordeaux, Talence	FRANCE
National Food Administration, Uppsala	SWEDEN
Systembolagets Laboratorium, Haninge	SWEDEN
Chemisches Untersuchungsamt, Trier	GERMANY
State General Laboratory, Nicosia	CYPRUS
Finnish Customs Laboratory, Espoo	FINLAND
<i>Central Science Laboratory, York</i>	UNITED KINGDOM
E.T.S. Laboratories, St. Helena, CA	UNITED STATES

11. REFERENCES

- [1] A. Visconti, M. Pascale, G. Centonze. *Determination of ochratoxin A in wine by means of immunoaffinity column clean-up and high-performance liquid chromatography*. Journal of Chromatography A, 864 (1999) 89-101.
- [2] AOAC International 1995, AOAC Official Methods Program, p. 23-51.

**COMPENDIUM OF INTERNATIONAL METHODS OF ANALYSIS - OIV
Ochratoxin A**

APPENDIX I

The following data was obtained in inter-laboratory tests, according to harmonised protocol recommendations for joint studies in view of validating an analysis method.

WHITE WINE		Added OTA ($\mu\text{g/l}$)			
Sample	White	0.100	1.100	2.000	n.c.
Inter-laboratory test year	1999	1999	1999	1999	1999
Number of laboratories	16	16	16	16	16
Number of laboratories retained after eliminating absurd findings	14*	13*	14	14	15
Number of eliminated laboratories	-	1	2	2	1
Number of accepted results	28	26	28	28	30
Average value ($\mu\text{g/l}$)	<0,01	0,102	1,000	1,768	0,283
Spread-type/Repeatability _r ($\mu\text{g/l}$)	-	0.01	0.07	0.15	0.03
Relative spread-type (Variation percentage) /Repeatability RSD _r (%)	-	10.0	6.6	8.5	10.6
Repeatability limit r ($\mu\text{g/l}$)	-	0.028	0.196	0.420	0.084
Spread-type/capacity of being reproduced s _R ($\mu\text{g/l}$)	-	0.01	0.14	0.23	0.04
Relative spread-type (variation percentage) /capacity of being reproduced RSD _R (%)	-	14.0	13.6	13.3	14.9
Capacity of being reproduced limit R ($\mu\text{g/l}$)	-	0.028	0.392	0.644	0.112
Extraction yield %	-	101.7	90.9	88.4	-

* 2 laboratories were excluded from the statistical 'evaluation due to high detection limit (= 0,2 $\mu\text{g/l}$).

n.c. = sample naturally contaminated

**COMPENDIUM OF INTERNATIONAL METHODS OF ANALYSIS - OIV
Ochratoxin A**

APPENDIX II

The following data was obtained in inter-laboratory tests, according to harmonised protocol recommendations for joint studies in view of validating an analysis method.

RED WINE	White	Added OTA ($\mu\text{g/l}$)			n.c.
		0.200	0.900	3.000	
samples					
Inter-laboratory test year	1999	1999	1999	1999	1999
Number of laboratories	15	15	15	15	15
Number of laboratories retained after eliminating absurd findings	14*	12*	14	15	14
Number of eliminated laboratories	-	2	1	-	1
Number of accepted results	28	24	28	30	28
Average value ($\mu\text{g/l}$)	<0.01	0.187	0.814	2.537	1.693
Spread-type/Repeatability _r ($\mu\text{g/l}$)	-	0.01	0.08	0.23	0.19
Relative spread-type (Variation percentage) /Repeatability RSD _r (%)	-	5.5	9.9	8.9	10.9
Repeatability limit r ($\mu\text{g/l}$)	-	0.028	0.224	0.644	0.532
Spread-type/capacity of being reproduced s _R ($\mu\text{g/l}$)	-	0.02	0.10	0.34	0.23
Relative spread-type (variation percentage) /capacity of being reproduced RSD _R (%)	-	9.9	12.5	13.4	13.4
Capacity of being reproduced limit R ($\mu\text{g/l}$)	-	0.056	0.280	0.952	0.644
Extraction yield %	-	93.4	90.4	84.6	-

* 1 laboratory was excluded from the statistical evaluation because of high detection limits (= 0,2 $\mu\text{g/l}$).

n.c. = naturally contaminated sample

APPENDIX III

**Guide to the critical points of the method of measuring ochratoxin A by
immunoaffinity column, type II.**

The critical points to observe are listed below for information purposes only and are a guide to applying the method. Numbering refers to paragraphs of the resolution.

1. Field of application

For information purposes only the method can be applied to grape musts, partially fermented grape musts, and new wines still under fermentation. The validation parameters concern wines only.

2. Principle

The method is broken down into two steps. The first step involves purification and concentration of the OTA in the wine or the must by capture on an immunoaffinity column followed by elution. The second step involves quantification of the eluate by HPLC using fluorescence detection.

3. Reagents

3.4 OTA stock solution

The use of OTA in solid form is not recommended; it is recommended to use a standard solution of OTA (point 3.5)

3.5 Standard OTA solution

Use of a commercial solution of standard concentration (around 50 µg/ml) with an analysis certificate stating the reference value and uncertainty of the concentration.

In theory the volume of these solutions is not certified, and they must be sampled with certified pipettes to constitute stock solutions from 0.25 to 1 mg/l in pure ethanol or in the mobile phase of the HPLC method (see 3.2.3). This solution is stable at -18°C for at least 4 years.

4. Equipment

4.13 RECOMMENDATIONS FOR ASSESSMENT OF THE PERFORMANCE OF IMMUNOAFFINITY COLUMNS (optional)

The step of concentration on an immunoaffinity column is a major source of inaccuracy in the analysis method. Experience shows that the various columns offered on the market could have recovery rates of between 70 and 100%.

It is therefore recommended to check the performance of a batch of columns before use. This step is recommended where there has been a change in supplier or column references.

4.13.1 Characterisation of the batch of columns (measure of recovery rate):
Select around 10 columns representative of the types of column routinely used in the laboratory, and all from different batch numbers. Prepare the same number of wines representing different matrices, with zero OTA concentrations, with known additions x_i of between 0.5 and $2 \mu\text{g}\cdot\text{kg}^{-1}$. After the known additions quickly analyse these n samples with the batch of selected columns. Let y_i be the values found.
The recovery rate data are calculated, the rate being the measured quantity in relation to the known added quantity.

$$t_i = \frac{y_i}{x_i} \quad (\text{recovery rate with column } i)$$

$$T = \frac{\sum t_i}{n} \quad (\text{average recovery rate})$$

$$S_t = \sqrt{\frac{\sum (t_i - T)^2}{n - 1}} \quad (\text{standard deviation of the recovery rate})$$

The standard deviation of the recovery rate calculated in this way represents not only the variability of the recovery rate of the columns, but also the standard uncertainty of the measurement system used after use of the columns (HPLC). It is nevertheless possible to establish a reasonable estimate of the standard deviation of the recovery rate of the columns by deducting the standard uncertainty of the HPLC system from the calculated recovery error:

- Estimate the standard uncertainty S_v (expressed as the standard deviation) of the measurement system in the strict sense of the word (without considering the the immunoaffinity column step).

For this it is possible to use a fidelity study on the OTA solutions.

The standard deviation of the recovery rate S_p is estimated as follows:

$$S_p = \sqrt{S_t^2 - S_v^2}$$

For a fairly wide concentration range, it is preferable to express this value as the coefficient of variation of the standard deviation (RSDR).

CV% = $S_p \cdot 100 /$ concentration of the addition

5. Procedure

The procedure outlined in point 5 is an example. The composition of dilution and washing solutions may differ from one column manufacturer to another. Likewise, the concentration of the diluted wine sample may be adjusted as needed.

6. Quantification of ochratoxine A (OTA)

6.1 Calibration curve

Prepare a calibration curve daily or each time that the chromatographic conditions change. Prepare the curve using solutions produced by diluting the stock solution in the mobile phase (see 3.2.3). The values chosen must provide the working range taking into account the concentration factor of the wine.

**HPLC-Determination of nine major anthocyanins
in red and rosé wine**

OENO 22/2003;
OENO 12/2007
OIV/OENO 377/2009

1. FIELD OF APPLICATION

The analytical method concerns the determination of the relative composition of anthocyanins in red and rosé wine. The separation is performed by HPLC with reverse phase column and UV-VIS detection.

Many authors [3, 6-17] have published data on the anthocyanin composition of red wines using similar analytical methods. For instance Wulf et al. [18] have detected and identified 21 anthocyanins and Heier et al. [13] nearly 40 by liquid chromatography combined with mass spectrometry. The anthocyanin composition may be very complex, so it is necessary to have a simple procedure. Consequently this method only determines the major compounds of the whole anthocyanin fraction.

Member states are encouraged to continue research in this area to avoid any non scientific evaluation of the results.

2. PRINCIPLE

Separation of the five most important non acylated anthocyanins (see Figure 1, peaks 1-5) and four major acylated anthocyanins (see Figure 1, peaks 6-9). Analysis of red and rosé wine by direct separation by HPLC by using reverse phase column with gradient elution by water/formic acid/acetonitrile with detection at 518 nm [1.2].

3 REAGENTS AND MATERIAL

Formic acid (p.a. 98 %) (CAS 64-18-6);
Water, HPLC grade;
Acetonitrile, HPLC grade (CAS 75-08-8);
HPLC solvents:
Solvent A: Water/Formic acid/Acetonitrile 87 : 10 : 3 (v/v/v)

Solvent B: Water/Formic acid/Acetonitrile 40 : 10 : 50 (v/v/v)

Membrane filter for HPLC solvent degassing and for sample preparation to be analysed.

Reference products for peak identification.

The HPLC analysis of anthocyanins in wine is difficult to perform due to the absence of commercially available pure products. Furthermore, anthocyanins are extremely unstable in solution.

The following anthocyanin pigments are commercially available:

Cyanidol-3-glucoside (also couromanin chloride); M = 484.84 g/mol

Peonidol-3-glucoside; M = 498.84 g/mol

Malvidol-3-glucoside (also Oeninchloride); M = 528.84 g/mol

Malvidol-3,5-diglucoside (also Malvinchloride); M = 691.04 g/mol

4. APPARATUS

HPLC system with:

binary gradient pump, injection system for sample volumes ranging from 10 to 200 µl,

diode array detector or a UV detector with a visible range,

integrator or a computer with data acquisition software,

furnace for column heating at 40°C,

solvent degassing system,

analytical column, for example:

LiChrospher 100 RP 18 (5 µm) in LiChroCart 250-4 guard column: for example RP 18 (30-40 mm) in a cartridge 2 mm in diameter x 20 mm long

5. PROCEDURE

5.1 Preparation of samples

Clear wines are poured directly without any preparation into the sample vials of the automatic sample changer. Cloudy samples are filtered using a 0.45 µm membrane filter for HPLC sample preparation. The first part of the filtrate should be rejected.

Since the range of the linearity of absorption depending on the concentration of anthocyanins is large, it is possible to modulate the injection volumes between 10 and 200 µl depending on the intensity of the wine colour. No significant difference between the results obtained for different injection volumes was observed.

5.2 Analysis

HPLC conditions

The HPLC analysis is carried out in the following conditions:

Injection Volume:	50 µl (red wine) up to 200 µl (rosé wine)
Flow:	0.8 ml/minute
Temperature:	40°C
Run time:	45 minutes
Post time:	5 minutes
Detection:	518 nm

Gradient elution:	Time (min)	Solvent A % (v/v)	Solvent B % (v/v)
	0	94	6
	15	70	30
	30	50	50
	35	40	60
	41	94	6

To check the column efficiency, the number of theoretical plates (N) calculated according to malvidol-3-glucoside should not be below 20,000, and the resolution (R) between peonidol-3-coumaryl glucoside and malvidolin-3-coumaryl glucoside should not be lower than 1.5. Below these values, the use of a new column is recommended.

COMPENDIUM OF INTERNATIONAL METHODS OF ANALYSIS-OIV Anthocyanins

A typical chromatogram is given in Figure 1, where the following anthocyanins are separated:

		Peak-N°
Group 1: “Nonacylated anthocyanidin-3-glucosides”:	delphinidol-3-glucoside	1
	cyanidol-3-glucoside	2
	petunidol-3-glucoside	3
	peonidol-3-glucoside	4
	malvidol-3-glucoside	5
Group 2: “Acetylated anthocyanidin-3-glucosides”:	peonidol-3-acetylglucoside	6
	malvidol-3-acetylglucoside	7
Group 3: “Coumarylated anthocyanidin-3-glucosides”:	peonidol-3-coumarylglucoside	8
	malvidol-3-coumarylglucoside	9

6. EXPRESSION OF RESULTS

Note that the values are expressed as relative amounts of the sum of the nine anthocyanins defined in this method.

7. LIMIT OF DETECTION AND LIMIT OF QUANTIFICATION

The limit of detection (LD) and the limit of quantification (LQ) are estimated following the instructions in the resolution OENO 7-2000 “Estimation of the Detection and Quantification Limits of a Method of Analysis“. Along the line of the ”Logic Diagram for Decision-Making” in N° 3 the graph approach has to be applied following paragraph 4.2.2.

For this purpose a part of the chromatogram is drawn out extendedly enclosing a range of a tenfold mid-height width ($w_{1/2}$) from an anthocyan relevant peak. Furthermore two parallel lines are drawn which just enclose the maximum amplitude of the signal window. The distance of these two lines gives h_{max} , expressed in milli Absorption Units (mAU).

The limit of detection (LD) and the limit of quantification (LQ) depend on the

individual measurement conditions of the chemical analysis and are to be determined by the user of the method. The Annex gives an example of its determination with the following results:

$$h_{\max} = 0,208 \text{ [mAU]}; \text{ LD} = 3 \times 0,208 \text{ [mAU]} = 0,62 \text{ [mAU]}.$$
$$\text{LQ} = 10 \times 0,208 \text{ [mAu]} = 2,08 \text{ [mAU]}.$$

Recommendation:

With combined data out of the whole Anthocyanin composition such as the sum of Acylated Anthocyanins or the ratio of Acetylated to Coumarylated Anthocyanins the calculation should not be carried out in cases where one of the components is below the limit of quantification (LQ).

On the other hand measurements below the limit of quantification (LQ) are not devoid of information content and may well be fit for purpose [1].

Bibliography:

[1] Thompson, M.; Ellison, S.L.R. ; Wood, R., Harmonized Guidelines for Single-Laboratory Validation of Methods of Analysis, Pure Appl. Chem. (2002) 74: 835-855

8. FIDELITY PARAMETERS

The repeatability (r) and the reproducibility (R) values for the nine anthocyanins are given in Table 2 and depend on the amount of the peak area. The uncertainty measurement of a particular peak area is determined by the value of r and R which corresponds to the nearest value given in Table 2.

The values made up of validation data can be calculated by following the appropriate statistical rules. To calculate the total error (sr) for example of the sum of acetylated anthocyanins, the variances (sr²) of specific the total error of ratios, for example, that of acetylated to coumarylated anthocyanins the square of relative errors (=sr/ai) are to be added. By using these rules, all the fidelity values can be calculated by using the data in Table 2.

COMPENDIUM OF INTERNATIONAL METHODS OF ANALYSIS-OIV
Anthocyanins

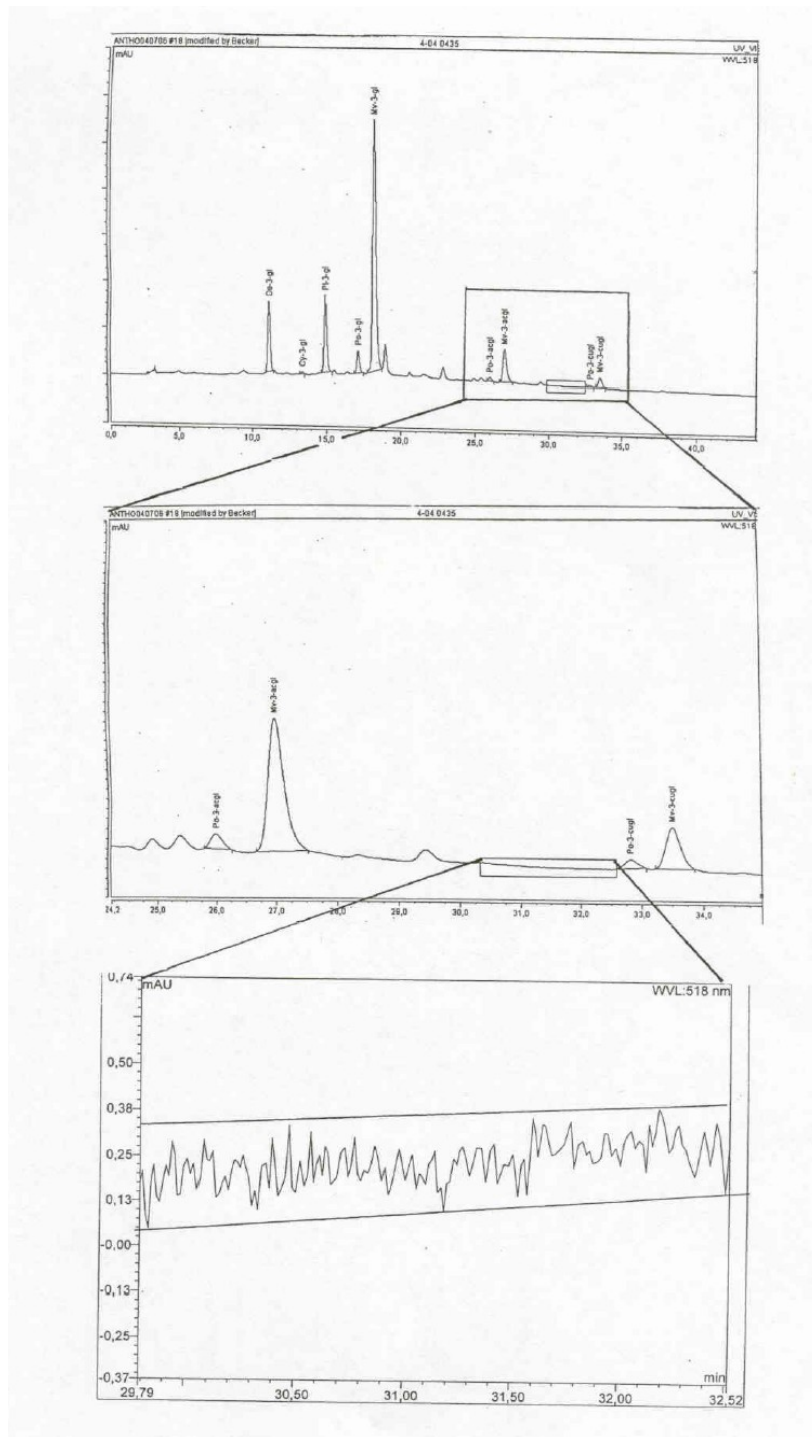

Annex A

Bibliography

- [1] Marx, R., B. Holbach, H. Otteneder; Determination of nine characteristic Anthocyanins in Wine by HPLC; OIV, F.V.N° 1104 2713/100200
- [2] Holbach, B., R. Marx, M. Ackermann; Bestimmung der Anthocyanzusammensetzung von Rotwein mittels Hochdruckflüssigkeitschromatographie (HPLC). *Lebensmittelchemie* (1997) 51: 78 - 80
- [3] Eder, R., S. Wendelin, J. Barna; Auftrennung der monomeren Rotweanthocyane mittels Hochdruckflüssigkeitschromatographie (HPLC). Methodenvergleich und Vorstellung einer neuen Methode. *Mitt. Klosterneuburg* (1990) 40: 68-75
- [4] ISO-5725-2: 1994 "Accuracy (trueness and precision) of measurement methods and results - Part 2: Basic method for the determination of repeatability and reproducibility"
- [5] Otteneder, H., Marx, R., Olschimke, D.; Method-performance study on the determination of nine characteristic anthocyanins in wine by HPLC. O.I.V. F.V.N° 1130 (2001)
- [6] Mattivi F.; Scienza, A.; Failla, O.; Vika, P.; Anzani, R.; Redesco, G.; Gianazza, E.; Righetti; P. *Vitis vinifera* - a chemotaxonomic approach: Anthocyanins in the skin. *Vitis (special issue)* 1990, 119-133
- [7] Roggero, I.P.; Larice, I.L.; Rocheville-Divorne, C.; Archier, P.; Coen, V. Composition Antocyanique des cepages. *Revue Francaise d'Oenologie* 1998, 112, 41-48
- [8] Eder, R.; Wendelin, S; Barna, J. Classification of red wine cultivars by means of anthocyanin analysis. *Mitt. Klosterneuburg* 1994, 44, 201-212
- [9] Arozarena, I.; Casp, A.; Marin, R.; Navarro, M. Differentiation of some Spanish wines according to variety and region based on their anthocyanin composition. *Eur. Food Res. Technol.* 2000, 212, 108-112
- [10] Garcia-Beneytez, E.; Revilla, E.; Cabello, F. Anthocyanin pattern of several red grape cultivars and wines made from them. *Eur. Food Res.*

Technol. **2002**, *215*, 32-37

- [11] Arozarena, I.; Ayestarán, B.; Cantalejo, M.J.; Navarro, M.; Vera, M.; Abril, K.; Casp, A. *Eur. Food Res. Technol.* **2002**, *214*, 313-309
- [12] Revilla, E.; Garcia-Beneytez, E.; Cabello, F.; Martin-Ortega, G.; Ryan, J-M. Value of high-performance liquid chromatographic analysis of anthocyanins in the differentiation of red grape cultivars and red wines made from them. *J. Chromatogr A* **2001**, *915*, 53-60
- [13] Heier, A.; Blaas, W.; Droß, A.; Wittkowski, R.; Anthocyanin Analysis by HPLC/ESI-MS, *Am.J.Enol.Vitic*, **2002**, *53*, 78-86
- [14] Arozarena, I.; Casp, A.; Marin, R.; Navarro, M. Multivariate differentiation of Spanish red wines according to region and variety. *J. Sci. Food Agric*, **2000**, *80*, 1909-1917
- [15] Anonymous. Bekanntmachung des Bundesinstituts für gesundheitlichen Verbraucherschutz und Veterinärmedizin. *Bundesgesundheitsbl. Gesundheitsforsch. Gesundheitsschutz*, **2001**, *44*, 748
- [16] Burns, I.; Mullen, W.; Landrault, N.; Teissedre, P.-L.; Lean, M.E.I.; Crozier, A. Variations in the Profile and Content of Anthocyanins in Wines made from Cabernet Sauvignon and hybrid grapes. *J. Agric. Food Chem.* **2002**, *50*, 4096-4102
- [17] Otteneder, H.; Holbach, B.; Marx, R.; Zimmer, M. Rebsortenbestimmung in Rotwein mittels Anthocyanenspektrum. *Mitt. Klosterneuburg*, **2002**, *52*, 187-194
- [18] L.W. Wulf and C.W. Nagel; High-Pressure liquid chromatographic separation of Anthocyanins of *Vitis vinifera*. *Am.J.Enol.Vitic* **1978**, *29*, 42-49

Annex B

Statistical results

Method performance study and evaluation

17 laboratories from 5 European Nations participated in the validation study of the method under the coordination of the German Official State Laboratory for Food Chemistry in Trier. The participants are listed in Table 3. An example of a chromatogram is presented in Figure 1 and the detailed results are given in Table 2.

The statistical evaluation followed the Resolution 6/99 and the Standard ISO 5725-1944 [4.5].

The chromatograms sent back with the results sheets fulfilled all requirements concerning the performance of the analytical column. No laboratory had to be completely eliminated, for example, because of a wrong peak identification.

The outlier values were searched using Dixon and Grubbs outlier testing according to the procedure for “Harmonised Protocol – IUPAC 1994” and the OIV Resolution OENO 19/2002. The values of s_r , s_R , r and R were calculated for 9 major anthocyanins at 5 content levels. For analytical results, the values of the closest levels should be used.

In order to have a global vision of the method performance, all the values RSD_r et RSD_R - gathered are grouped by range of areas in the following table:

Table 1: Summary of the results of the method performance study

Range of relative peak areas* [%]	Range of RSD_r [%]	Range of RSD_R [%]
>0.4 – 1.0	6.8 - 22.4	20.6 - 50.9
>1.1 – 1.5	4.2 - 18.1	11.8 - 28.1
>1.5 – 3.5	2.1 – 7.7	10.6 - 15.6
>3.5 – 5.5	2.7 – 5.7	18.7 – 7.5
>5.5 – 7.5	2.4 – 3.9	6.5 - 10.0
>10 – 14	1.1 – 2.9	3.7 - 9.2
>14 – 17	1.0 - 3.9	3.2 - 5.4
>50 – 76	0.3 - 1.0	2.1 - 3.1
* independent of anthocyanin		

This leads to the conclusion that repeatabilities and reproducibilities depend on the total sum of the relative peak areas. The higher they are, the better are RSDr and RSDR. For anthocyanin contents close to the detection limit (e.g. Cyanidin-3-glucoside) with small relative areas (less than 1%) the RSDr et RSDR values can rise significantly. For anthocyanin whose relative areas are more than 1%, the RSDr and RSDR values are reasonable.

Figure 1: Separation of 9 anthocyanins in red wine

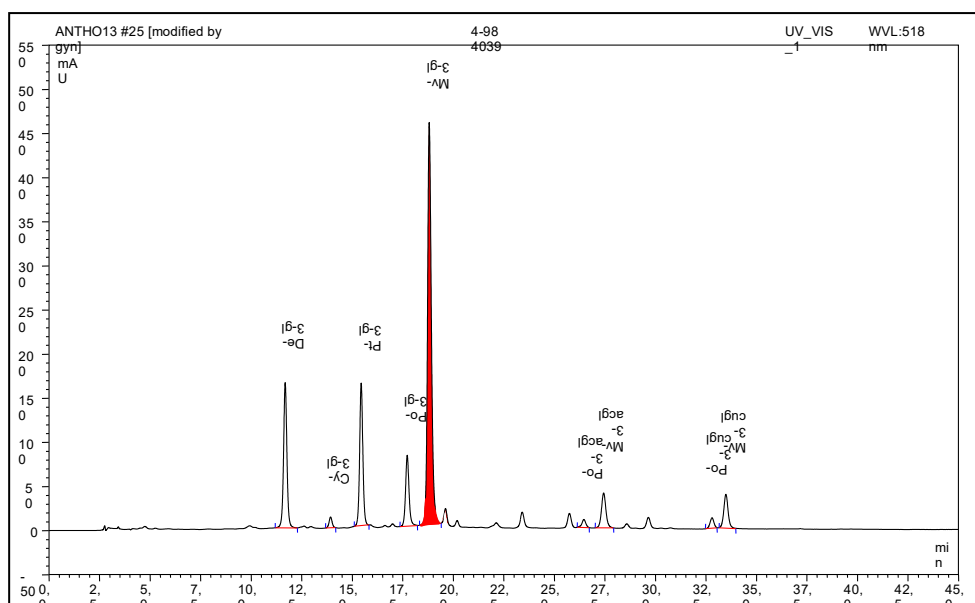

**COMPENDIUM OF INTERNATIONAL METHODS OF ANALYSIS-OIV
Anthocyanins**

Table 2: Results of the method performance study

Anthocyanin	sample 1	sample 2	sample 3	sample 4	sample 5
<i>Delphinidol-3-glucoside</i>					
n	14	14	16	15	16
mean	6.75	14.14	3.45	16.68	3.54
s _r	0.163	0.145	0.142	0.142	0.108
RSD _r (%)	2.4	1.0	4.1	0.8	3.1
r	0.46	0.41	0.40	0.40	0.30
s _R	0.544	0.462	0.526	0.704	0.490
RSD _R (%)	8.1	3.3	15.2	4.2	13.8
R	1.52	1.29	1.47	1.97	1.37
<i>Cyanidol-3-glucoside</i>					
n	16	17	16	15	14
mean	2.18	1.23	0.61	1.46	0.34
s _r	0.086	0.053	0.043	0.110	0.031
RSD _r (%)	4.0	4.3	7.1	7.5	9.2
r	0.24	0.15	0.12	0.31	0.09
s _R	0.460	0.211	0.213	0.180	0.158
RSD _R (%)	21.2	17.2	34.9	12.3	46.7
R	1.29	0.59	0.60	0.50	0.44
<i>Petunidol-3-glucoside</i>					
n	15	17	16	14	15
mean	10.24	14.29	5.75	12.21	6.19
s _r	0.233	0.596	0.157	0.097	0.196
RSD _r (%)	2.3	4.2	2.7	0.8	3.2
r	0.65	1.67	0.44	0.27	0.55
s _R	0.431	0.996	0.495	0.469	0.404
RSD _R (%)	4.2	7.0	8.6	3.8	6.5
R	1.21	2.79	1.39	1.31	1.13
<i>Peonidol-3-glucoside</i>					
n	16	15	17	17	16
mean	11.88	6.23	13.75	7.44	4.12
s _r	0.241	0.166	0.144	0.232	0.174
RSD _r (%)	2.0	2.7	1.0	3.1	4.2
r	0.68	0.47	0.40	0.65	0.49
s _R	0.981	0.560	1.227	0.602	0.532
RSD _R (%)	8.3	9.0	8.9	8.1	12.9
R	2.75	1.57	3.44	1.69	1.49
<i>Malvidol-3-glucoside</i>					
n	16	15	17	16	16
mean	55.90	55.04	76.11	52.60	61.04
s _r	0.545	0.272	0.251	0.298	0.377
RSD _r (%)	1.0	0.5	0.3	0.6	0.6
r	1.53	0.76	0.70	0.83	1.06
s _R	2.026	2.649	2.291	1.606	1.986
RSD _R (%)	3.6	4.8	3.0	3.1	3.3
R	5.67	7.42	6.41	4.50	5.56
n	= N° of laboratories retained after eliminating outliers				
s _r	= standard deviation of repeatability				
RSD _r (%)	= relative standard deviation of repeatability				
r	= repeatability				
s _R	= standard deviation of reproducibility				
RSD _R (%)	= relative standard deviation of reproducibility				
R	= reproducibility				

**COMPENDIUM OF INTERNATIONAL METHODS OF ANALYSIS-OIV
Anthocyanins**

Table 2: Results of the method performance study

Anthocyanin	sample 1	sample 2	sample 3	sample 4	sample 5
<i>Peonidol-3-acetylglucoside</i>					
n	14	16		14	16
mean	1.16	1.44		0.59	3.74
s _r	0.064	0.062		0.059	0.215
RSD _r (%)	5.5	4.3		10.1	5.8
	0.18	0.17		0.17	0.60
s _R	0.511	0.392		0.272	0.374
RSD _R (%)	43.9	27.2		46.4	10.0
R	1.43	1.10		0.76	1.05
<i>Malvidol-3-acetylglucoside</i>					
n	16	17		17	16
mean	5.51	4.84		3.11	15.07
s _r	0.176	0.167		0.088	0.213
RSD _r (%)	3.2	3.4		2.8	1.4
r	0.49	0.47		0.25	0.60
s _R	0.395	0.366		0.496	0.617
RSD _R (%)	7.2	7.6		16.0	4.1
R	1.11	1.02		1.39	1.73
<i>Peonidol-3-coumarylglucoside</i>					
n	16	14		17	16
mean	1.26	0.90		0.89	1.32
s _r	0.130	0.046		0.060	0.058
RSD _r (%)	10.3	5.1		6.8	4.4
r	0.36	0.13		0.17	0.16
s _R	0.309	0.109		0.204	0.156
RSD _R (%)	24.5	12.2		23.0	11.8
R	0.86	0.31		0.57	0.44
<i>Malvidol-3-coumarylglucoside</i>					
n	17	17		17	16
mean	4.62	2.66		4.54	4.45
s _r	0.159	0.055		0.124	0.048
RSD _r (%)	3.4	2.1		2.7	1.1
r	0.45	0.15		0.35	0.13
s _R	0.865	0.392		0.574	0.364
RSD _R (%)	18.7	14.7		12.6	8.2
R	2.42	1.10		1.61	1.02
n	= N° of laboratories retained after eliminating outliers				
s _r	= standard deviation of repeatability				
RSD _r (%)	= relative standard deviation of repeatability				
r	= repeatability				
s _R	= standard deviation of reproducibility				
RSD _R (%)	= relative standard deviation of reproducibility				
R	= reproducibility				

**COMPENDIUM OF INTERNATIONAL METHODS OF ANALYSIS-OIV
Anthocyanins**

Table 3: List of participants

ABC Labor Dahmen, Mülheim/Mosel	<u>D</u>
Chemisches Landes- und Staatliches Veterinäruntersuchungsamt Münster	D
Institut für Lebensmittelchemie Koblenz	D
Institut für Lebensmittelchemie Speyer	D
Institut für Lebensmittelchemie Trier	D
Institut für Lebensmittelchemie und Arzneimittel Mainz	D
Labor Dr. Haase-Aschoff, Bad Kreuznach	D
Labor Dr. Klaus Millies, Hofheim-Wildsachsen	D
Labor Heidger, Kesten	D
Landesveterinär- und Lebensmitteluntersuchungsamt Halle	D
Staatliche Lehr- und Forschungsanstalt für Landwirtschaft, Weinbau und Gartenbau, Neustadt/Weinstraße	D
Staatliches Institut für Gesundheit und Umwelt, Saarbrücken	D
Staatliches Medizinal-, Lebensmittel- und Veterinäruntersuchungsamt, Wiesbaden	D
Laboratoire Interrégional de la D.G.C.C.R.F de Bordeaux, Talence/France	<u>F</u>
Unidad de Nutricion y Bromotologia, Facultad de Farmacia, Universidad de Salamanca, Salamanca/Espana	<u>E</u>
University of Glasgow, Div. of Biochem. and Molek. Biology	<u>UK</u>
Höhere Bundeslehranstalt und Bundesamt für Wein- und Obstbau, Klosterneuburg	<u>A</u>

17 Laboratories D (13); A (1); F (1); E (1); UK (1)

Method OIV-MA-AS315-12

Type IV method

Determination of plant proteins in wines and musts

(OENO 24/2004; OIV/OENO 377/2009)

The technique developed below enables to determine the quantity of proteins possibly remaining in beverages treated with proteins of plant origin after racking.

1 PRINCIPLE

Wine and must proteins are precipitated with trichloroacetic acid, then they are separated by electrophoresis in polyacrylamide gel in the presence of dodecyl sodium sulphate (DSS). The addition of Coomassie blue colours the proteins. The intensity of the colouration enables to determine the protein content using a calibration curve made beforehand with the known protein concentration solutions. The antigenic capacity of musts and treated wines is determined by immunoblotting testing.

2 PROTOCOL

2.1 Concentration of proteins by precipitation with trichloroacetic acid (TCA)

2.1.1 Reagents

2.1.1.1 Pure trichloroacetic acid (TCA)

2.1.1.2 TCA at 0.1% prepared using 2.1.1.1: 0.1 g in 100 ml of water.

2.1.1.3 TCA at 100% prepared using 2.1.1.1: 100 g in 100 ml of water.

2.1.1.4 Sodium hydroxide 0.5 M

2.1.1.5 Buffer Tris/HCl 0.25 M pH=6.8

30.27 g of Tris-(hydroxymethyl)aminomethane (Tris) are dissolved in 300 ml of distilled water. The pH is adjusted to 6.8 with concentrated

**COMPENDIUM OF INTERNATIONAL ANALYSIS OF METHODS -
OIV
Plant proteins**

hydrochloric acid for analysis. The volume is completed to 1 l with distilled water. The buffer is stored at 4°C.

2.1.1.6 Pure glycerol

2.1.1.7 Pure dodecyl sodium sulphate (DSS)

2.1.1.8 Pure 2-mercaptoethanol

2.1.1.9 Buffer solution for samples: it is made up of a buffer Tris/HCl 0.25 M, pH=6.8 (2.1.1.5); 7.5% of pure glycerol (2.1.1.6); 2% of dodecyl sodium sulphate (DSS) (2.1.1.7) and 5% of pure 2-mercaptoethanol (2.1.1.8). The percentages of different reagents correspond to the final concentration in the buffer solution.

2.1.2 Procedure

3 ml of trichloroacetic acid at 100% (2.1.1.3) and 24 ml of wine or must (treated or untreated) are successively put in 50 ml centrifuge tubes. The final concentration in TCA thus obtained is 11%.

After 30 minutes at 4°C, the samples are centrifuged at 10,000 rpm for 30 minutes at 4°C. The pellets are washed in an aqueous solution of TCA at 0.1% (2.1.1.2), re-centrifuged and put again in suspension in 0.24 ml mixture (1:1, v/v) of sodium hydroxide 0.5 M (2.1.1.4) and buffer solution (2.1.1.9). The samples are heated at 100°C in a water bath for 10 minutes.

2.2 Electrophoresis in Polyacrylamide Gel in the presence of DSS

2.2.1 Reagents

2.2.1.1 Buffer Tris/HCl 1.5 M pH=8.8

181.6 g of Tris-(hydroxymethyl)aminomethane are dissolved in 300 ml of distilled water. The pH is adjusted at 8.8 with concentrated hydrochloric acid for analysis. The volume is completed to 1 l with distilled water. The buffer is stored at 4°C.

2.2.1.2 Mixture of acrylamide (30%)–bis-acrylamide (0.8%)–glycerol (75%)

Slowly add 300 g of acrylamide and 8 g of bis-acrylamide to 600 ml of a glycerol solution at 75%. After dissolution, adjust the volume to 1 l with glycerol at 75%. The mixture is stored in the dark at room temperature.

2.2.1.3 DSS at 10%

**COMPENDIUM OF INTERNATIONAL ANALYSIS OF METHODS -
OIV
Plant proteins**

10 g of DSS are dissolved in 100 ml of distilled water. Store at room temperature.

2.2.1.4 N,N,N',N'-tetramethylethylenediamine (TEMED) for electrophoresis

2.2.1.5 Ammonium persulfate at 10%

1 g of ammonium persulfate is dissolved in 10 ml of distilled water. Store at 4°C.

2.2.1.6 Bromophenol blue solution

10 mg of bromophenol blue for electrophoresis are dissolved in 10 ml of distilled water.

2.2.1.7 Solution for the separation gel (15% of acrylamide)

It is prepared just before use:

- 1.5 ml of Tris/HCl 1.5 M, pH=8.8 (2.2.1.1),
- 1.5 ml of distilled water,
- 3 ml of glycerol acrylamide mixture (2.2.1.2),
- 50 µl of DSS 10% (2.2.1.3),
- 10 µl of N,N,N',N'-tetramethylethylenediamine (TEMED) for electrophoresis (2.2.1.4),
- 20 µl of ammonium persulfate (2.2.1.5).
- 1 drop of bromophenol blue (2.2.1.6)

2.2.1.8 Buffer Tris/HCl 0.5 M pH=6.8

60.4 g of Tris-(hydroxymethyl)aminomethane are dissolved in 400 ml of distilled water. The pH is adjusted to 6.8 with concentrated hydrochloric acid for analysis. The volume is completed to 1 l with distilled water. The buffer is stored at 4°C.

2.2.1.9 Mixture of acrylamide (30%)–bis-acrylamide (0.8%)–water

Slowly add 300 g of acrylamide and 8 g of bis-acrylamide to 300 ml of water. After dissolution, adjust the volume to 1 l with distilled water. The mixture is stored in the dark at room temperature.

2.2.1.10 Concentration gel at 3.5% of acrylamide

It is prepared just before use:

- 0.5 ml of Tris/HCl 0.5 M pH=6.8 (2.2.1.8),
- 1.27 ml of distilled water,
- 0.23 ml of water acrylamide mixture (2.2.1.9),
- 20 µl of DSS 10% (2.2.1.3),
- 5 µl of N,N,N',N'-tetramethylethylenediamine (TEMED) for electrophoresis (2.2.1.4),
- 25 µl of ammonium persulfate (2.2.1.5),
- 1 drop of bromophenol blue (2.2.1.6).

2.2.1.11 Migration buffer

**COMPENDIUM OF INTERNATIONAL ANALYSIS OF METHODS -
OIV
Plant proteins**

30.27 g of Tris-(hydroxymethyl)aminomethane, 144 g of glycine and 10 g of DSS are dissolved in 600 ml of distilled water. The pH should be 8.8. If necessary, it is adjusted with concentrated hydrochloric acid for analysis. The volume is completed to 1 l with distilled water. The buffer is stored at 4°C. At the time of use, the solution is diluted to 1/10 in distilled water.

2.2.1.12 Colouring solution

Are successively mixed:

- 16 ml of ultra-pure Coomassie brilliant blue G-250 at 5% (5 g in 100 ml of distilled water),
- 784 ml from a 1 l solution where 100 g of ammonium sulphate and 13.8 ml of orthophosphoric acid at 85% were dissolved for analysis,
- 200 ml of absolute ethanol.

2.2.1.13 Discolouring solution

Are successively mixed:

- 100 ml of glacial acetic acid 100% for analysis,
- 200 ml of absolute ethanol for analysis.
- 700 ml of distilled water.

2.2.2 Procedure

The separation gel solution (2.2.1.7) is poured between two glass plates of 7x10cm. The upper surface of the gel is levelled by the addition of 2 drops of distilled water.

After polymerisation of the separation gel and the elimination of water, 1 ml of concentration gel (2.2.1.10) is deposited on the separation gel using a 1 ml pipette. Then the comb is set up whose imprints will create deposit wells.

The samples necessary for the calibration range are prepared in a mixture (1:1), v/v, 0.5% M sodium hydroxide (2.1.1.4) and the buffer solution (2.1.1.9) in order for the calibration range be between 5 µg/ml and 50 µg/ml.

20 to 30 µl of wine and calibration solution are deposited in the wells.

After migration (at a constant voltage of 90 V) at room temperature for about 3-4 hours, the gels are removed from the mould. They are immediately plunged into 50 ml of an aqueous solution of TCA 20% for 30 minutes then in 50 ml of the colouring solution (2.2.1.12).

The proteins appear in the form of blue coloured bands. The gel is then discoloured with 50 ml of discolouring solution (2.2.1.13). When the bottom of the gel is transparent, it is placed in distilled water for storage.

3. QUANTITATIVE ANALYSIS

The intensity of each spot is evaluated by using a scanner for gel with an image analyser software. The quantity of protein on the gel is determined by the calculation of the average density of the pixels of the band and by integration of the band width. The protein content of each sample is obtained using a calibration curve. The points of this curve are obtained by tracing the known concentration values of plant proteins deposited on the gel depending on the corresponding integration area.

The detection and quantification limit is about 0.030 ppm for peas and at 0.36 ppm for gluten, in an environment concentrated 100 times. The coefficient of variation is always below 5%.

4 SEARCH BY IMMUNOBLOTTING OF THE ANTIGENIC POTENTIAL OF WINES AND MUSTS TREATED

The antigenic capacity of proteins that could remain in the beverages treated after racking is then evaluated.

4.1 PRINCIPLE

After electrophoresis, the gels are submitted to the immunoblotting technique. The proteins are transferred to a membrane where they are adsorbed. An antigen-antibody complex is formed by the addition of a plant anti-protein antibody (for example anti-gliadin antibodies if the plant protein is gluten). The method is revealed by the addition of an antibody directed against the plant anti-protein antibodies coupled with phosphatase. In the presence of the chromogenic substrate of the enzyme, a colouration whose intensity will be proportional to the quantity of immunocomplexes will develop. This immunoreactivity will be quantified using a calibration curve made with known concentration plant proteins solutions.

4.2 PROTOCOL

4.2.1 : Reagents

4.2.1.1 Transfer buffer

3.03 g of Tris, 14.4 g of glycine (R), 200 ml of methanol (R) are mixed and completed to 1 l with distilled water.

4.2.1.2 Gelatine 1%

8.77 g of sodium chloride (R), 18.6 g of ethylenediaminetetraacetic acid (EDTA) for analysis, 6.06 g of Tris and 0.5 ml of Triton X are dissolved in 800 ml of distilled water. The pH is adjusted to 7.5 with concentrated hydrochloric acid for analysis. 10 g of gelatine are added and the volume is completed to 1 l.

4.2.1.3 Gelatine 0.25%

8.77 g of sodium chloride (R), 18.6 g of ethylenediaminetetraacetic acid (EDTA) for analysis, 6.06 g of Tris and 0.5 ml of Triton X are dissolved in 800 ml

**COMPENDIUM OF INTERNATIONAL ANALYSIS OF METHODS -
OIV
Plant proteins**

of distilled water. The pH is adjusted to 7.5 with concentrated hydrochloric acid for analysis. 2.5 g of gelatine are added and the volume is completed to 1 l.

4.2.1.4 Polyclonal antibody solution (marketed or described in the annex)

- 10 µl of polyclonal plant anti-protein antibodies
- q.s.f. 10 ml with gelatine at 0.25% (4.2.1.3).

4.2.1.5 TBS buffer

29.22 g of sodium chloride for analysis and 2.42 g of tris are dissolved in 1 l of distilled water.

4.2.1.6 Alkaline phosphatase buffer

5.84 g of sodium chloride (R), 1.02 g of magnesium chloride (R) and 12.11 g of Tris are dissolved in 800 ml of distilled water. The pH is adjusted to 9.5 with concentrated hydrochloric acid and the volume is completed to 1 l.

4.2.1.7 Developer

15 g of bromochloroindol phosphate (BICP) and 30 g of nitro blue tetrazolium (NBT) are dissolved in 100 ml of alkaline phosphatase buffer (4.2.1.6).

4.2.2 Procedure

After electrophoresis, the proteins are transferred from the gel to a membrane of polyvinylidene difluoride by electrophoretic elution: 16 hours at 4°C at 30 V in the transfer buffer (4.2.1.1). The membranes are saturated with gelatine at 1% (4.2.1.2) and washed 3 times with gelatine at 0.25% (4.2.1.3). The gelatine becomes set on free sites and inhibits non specific adsorption of immunological reagents. The membrane is then plunged into 10 ml of the plant anti-protein polyclonal antibody solution (4.2.1.4). For gluten, the anti-gliadin antibodies are purchased. The other antibody types are prepared according to the method provided for in the annex. The IgG-antigen complex is detected by the addition of 10 µl of anti-IgG rabbit antibodies marked with alkaline phosphatase. The membranes are washed twice with gelatine 0.25% (4.2.1.3) and once with the TBS buffer (4.2.1.5). After incubation in the developer (4.2.1.7), a dark purple precipitate is formed in the spot where the enzyme is attached.

4.3 QUANTITATIVE ANALYSIS

In order to calculate the quantity of residual immunoreactivity of a marketed wine, a calibration curve is traced out: known concentrations of plant proteins deposited on the gel (and transferred to a membrane) depending on the areas obtained by integration of the intensity of the spots corresponding to the formation of immune-complex. The analysis is done with the same equipment as for analysing electrophoresis gels.

ANNEX

Production of polyclonal anti-peas

Anti-peas polyclonal antibodies necessary for the determination of antigenic capacity of pea proteins in wine and musts treated are being carried out on animals.

1 Principle

Serums containing polyclonal antibodies are obtained from New Zealand rabbits after an intradermal injection of antigen.

2 Protocol

2.1 Reagents

2.1.1 PBS pH=7.4 phosphate buffer: 8 g of NaCl, 200 mg of KCl, 1.73 of Na₂HPO₄ H₂O and 200 mg of KH₂PO₄ are dissolved in 300 ml of distilled water. pH is adjusted to 7.4 with sodium hydrate 1 M. The volume is brought to 1 l with distilled water.

2.1.2 Antigens:

10 mg of pea protein is dissolved in 5 ml of PBS phosphate buffer (2.1.1). The solution is then filtered under sterile conditions through 0.2 µm and stored at -20°C until the day of immunization.

2.2 Procedure

1 ml of 2.1.2. solution is mixed with 1 ml of Freund complete adjuvant. 1 ml of this mixture is injected intradermally to a New Zealand rabbit weighing approximately 3 kg. This injection is repeated on day 15, day 30 and day 45.

60 days after the first injection, 100µl of blood were withdrawn from the auricular vein which was then tested for its capacity to react to antigens. Immunoblotting was used for this evaluation as described in Chapter 4.2 of the analysis method using a gel with a pea protein which migrated on the gel.

After checking the formation of an antigen-antibody complex, 15 ml of blood were withdrawn from the auricular vein. The blood is placed at 37°C for 30 minutes. The serum containing the anti-pea polyclonal antibodies is withdrawn after centrifuging the blood at 3000 rpm for 5 minutes.

**COMPENDIUM OF INTERNATIONAL ANALYSIS OF METHODS -
OIV
Polychlorophenols, Polychloroanisols**

Method OIV-MA-AS315-13

Type IV method

**Determining the presence and content of polychlorophenols
and polychloroanisols in wines, cork stoppers, wood and
bentonites used as atmospheric traps**
(OENO 8/2006)

WITHDRAWN
(Replaced by OIV-MA-AS315-16)

Method OIV-MA-AS315-14

Type IV method

**Measurement of lysozyme in wine
by high performance liquid chromatography
OENO 8/2007; OIV/OENO 377/2009**

1. Introduction

It is preferable to have an analysis method available for lysozyme which is not based on enzyme activity.

2. Scope

The method allows the quantification of lysozyme (mg of protein per l) present in red and white wines independently of the enzyme activity (which could be inhibited by partial denaturation or by complex formation or coprecipitation phenomena) found in the test solution.

3. Definition

HPLC provides an analytical approach based on steric, polar or adsorptive interactions between the stationary phase and the analyte, and is therefore not linked to the actual enzyme activity exhibited by the protein.

4. Principle

The analysis is carried out using HPLC with a spectrophotometric detector combined with a spectrofluorimetric detector. The unknown quantity in the wine sample is calculated on the chromatographic peak areas, using the external calibration method.

5. Reagents

5.1. Solvents and working solutions

HPLC analysis on Acetonitrile (CH₃CN)

Pure trifluoroacetic acid (TFA)

deionised water for HPLC analysis

Standard solution: Tartaric acid 1g/L, Ethyl alcohol 10% v/v, adjusted to pH 3.2 with neutral potassium tartrate.

**COMPENDIUM OF INTERNATIONAL ANALYSIS OF METHODS -
OIV
Lysozyme**

- 5.2. Eluents
A: CH₃CN 1%, TFA 0.2 %, H₂O= 98.8%
B: CH₃CN 70%, TFA 0.2 %, H₂O= 29.8%

- 5.3. Reference solutions
Quantities from 1 to 250 mg/L standard lysozyme, dissolved in standard solution by stirring continuously for at least 12 hours.

6. Equipment

- 6.1. HPLC apparatus equipped with a pumping system suitable for gradient elution
6.2. Thermostated column compartment (oven)
6.3. Spectrophotometer combined with spectrofluorimeter
6.4. 20 µL loop injection
6.5. Column: polymer in reverse phase with phenyl functional groups (diameter of pores = 1000 Å, exclusion limit = 1000000 Da) Toso Bioscience TSK-gel Phenyl 5PW RP, 7.5 cm x 4.6 mm ID as an example
6.6. Pre-column in the same material as the column: Toso Bioscience TSK-gel Phenyl 5PW RP Guardgel, 1.5 cm 3.2mm ID as an example

7. Preparation of the sample

The wine samples are acidified with HCl (10M) diluted 1/10 and filtered using a polyamide with 0.22 µm diameter pores filter, 5 minutes after the addition. The chromatography analysis is carried out immediately after filtering.

8. Operating conditions

- 8.1. Eluent flow-rate: 1mL/min
8.2. Temperature of column: 30°C
8.3. Spectrophotometric detection: 280 nm
8.4. Spectrofluorimetric detection:
 λ ex = 276 nm;
 λ em = 345 nm;
 Gain = 10
8.5. Gradient elution sequence

**COMPENDIUM OF INTERNATIONAL ANALYSIS OF METHODS -
OIV
Lysozyme**

Time (min)	A%	B%	gradient
0	100	0	
			isocratic
3	100	0	
			linear
10	65	35	
			isocratic
15	65	35	
			linear
27	40.5	59.5	
			linear
29	0	100	
			isocratic
34	0	100	
			linear
36	100	0	
			isocratic
40	100	0	

8.6 Average retention time of lysozyme: 25.50 minutes

9. Calculation

The reference solutions containing the following concentrations of lysozyme: 1; 5; 10; 50; 100; 200; 250 mg/L are analysed in triplicate. For each chromatogram, the peak areas corresponding to the lysozyme are plotted according to the respective concentrations, in order to obtain the linear regression lines expressed by the formula $Y = ax + b$. The correlation coefficient r^2 must be > 0.999

10. Characteristics of the method

A validation study was carried out for the purpose of assessing the suitability of the method for the purpose in question, taking into account linearity, limits of detection and quantification and the accuracy of the method. The latter

**COMPENDIUM OF INTERNATIONAL ANALYSIS OF METHODS -
OIV
Lysozyme**

parameter was determined by defining the levels of precision and trueness of the method.

10.1 Linearity of the method

Based on the results obtained from the linear regression analysis, the method proved to be linear within the ranges shown in the table below:

	Linearity range (mg/L)	Line gradient	Correlation coefficient (r^2)	LD (mg/L)	LQ (mg/L)	Repeatability (n=5) RSD%			Reproducibility (n=5) RSD%
						Std ¹	V.R. ²	V.B. ³	Std ¹
UV	5-250	3 786	0,9993	1,86	6,20	4,67	5,54	0,62	1,93
FLD	1-250	52 037	0,9990	0,18	0,59	2,61	2,37	0,68	2,30

Table 1: Data related to characteristics of the method: ¹ standard solution ; ² red wine ; ³ white wine

10.2 Limit of detection and limit of quantification

The detection limit (LD) and limit of quantification (LQ) were calculated as the signal equivalent to respectively 3 times and 10 times the background chromatography noise under working conditions on an actual test solution (table 1),

10.3 Precision of the method

The parameters taken into account were repeatability and reproducibility. Table 1 shows the values of these parameters (expressed as %age St.dv. of measurements repeated in different concentrations) found for standard solution, red wine and white wine

10.4 Trueness of the method

The percentage recovery was calculated on the standard solutions containing 5 and 50 mg/L of lysozyme, with known quantities of lysozyme added, as shown in the table below.

**COMPENDIUM OF INTERNATIONAL ANALYSIS OF METHODS -
OIV
Lysozyme**

	Nominal initial [C] (mg/L)	Quantity added (mg/L)	Theoretical [C] (mg/L)	[C] found	Std.Dev.	%age recovery
UV 280 nm	50	13.1	63.1	62.3	3.86	99
FD	50	13.1	63.1	64.5	5.36	102
UV 280 nm	5	14.4	19.4	17.9	1.49	92.1
FD	5	14.4	19.4	19.0	1.61	97.7

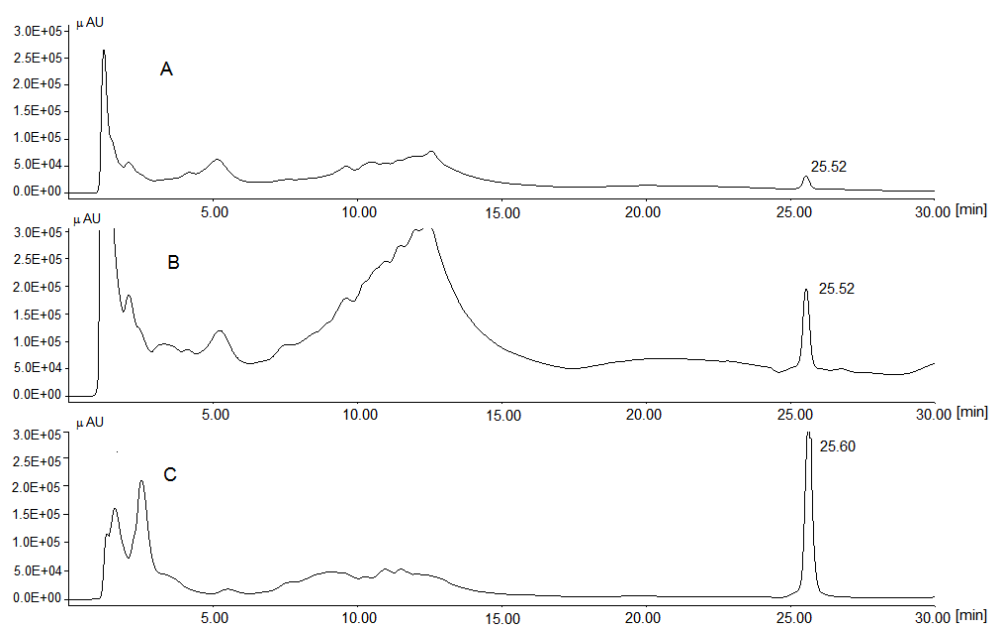

Fig.1 Chromatogram of red wine containing pure lysozyme (standard solution containing 1 000 mg/L of lysozyme was added to wine to obtain a final concentration of 125 mg/L of lysozyme). A: UV detector at 280 nm; B: UV detector at 225 nm; C: FLD detector (λ_{ex} 276 nm; λ_{em} 345 nm).

11. Bibliography

Claudio Riponi; Nadia Natali; Fabio Chinnici. Quantitation of hen's egg white lysozyme in wines by an improved HPLC-FLD analytical method. Am. J. Enol. Vit., in press.

Method OIV-MA-AS315-15

Type II method

Determination of 3-methoxypropane-1,2-diol and cyclic diglycerols (by-products of technical glycerol) in wine by GC-MS - description of the method and collaborative study - (OENO11/2007; OIV/OENO 377/2009)

1. Introduction

This is an internationally validated method for the determination of 3-methoxypropane-1,2-diol (3-MPD) and cyclic diglycerols (CycDs) - both being recognised as impurities of technical glycerol - in different types of wine. It is known that glycerol produced by transesterification of plant and animal triglycerides using methanol contains considerable amounts of 3-MPD. The synthesis of glycerol from petrochemicals leads to impurities of CycDs. One of the published methods [1, 2, 3] was adopted, modified and tested in an collaborative study. Here we present the optimized method and report the results of the collaborative study [2]. Design and assessment of the validation study followed the O.I.V. Resolution 8/2000 "Validation Protocol of Analytical Methods".

2. Scope

The described method is suitable for the determination of 3-MPD and 6 cyclic diglycerols (cis-, trans-2,6-bis(hydroxymethyl) 1,4-dioxane; cis-, trans-2,5-bis(hydroxymethyl) 1,4-dioxane; cis-, trans-2-hydroxymethyl-6-hydroxy-1,4-dioxepane) in white, red, sweet and dry wines. The study described covers the concentration range of 0.1 to 0.8 mg/L for 3-MPD and 0.5 to 1.5 mg/L for the CycDs.

3. Definitions

3-MPD	3-methoxypropane-1,2-diol
ANOVA	Analysis of Variance
C	Concentration
CycDs	Cyclic diglycerols
GC-MS	Gas chromatography – mass spectrometry
H ₂	Hydrogen
IS	Internal standard
m/z	mass/charge ratio
ML	Matrix calibration level
S0	Standard dilution 1000 ng/μL

**COMPENDIUM OF INTERNATIONAL ANALYSIS OF METHODS -
OIV**

3-Methoxypropane-1,2-diol and Cyclic Diglycerols

S1	Standard dilution 100 ng/μL
S2	Standard dilution 10 ng/μL

4. Principle

The analytes and the internal standard are salted-out by addition of K₂CO₃, and extracted using diethyl ether. Extracts are analyzed directly by GC-MS on a polar column. Detection is then carried out in selected ion monitoring mode.

5. Reagents and Materials

5.1. Chemicals

- 5.1.1 K₂CO₃ p.A .
- 5.1.2 Diethyl ether Uvasol for spectroscopy
- 5.1.3 Molecular sieve (2 mm diameter, pore size 0.5 nm)
- 5.1.4 Ethanol (Absolute)

5.2. Standards

- 5.2.1 Cyclic diglycerol mixture (6 components) Solvay Alkali GmbH ¹, 89.3 %
cis-, trans-2,6-bis(hydroxymethyl) 1,4-dioxane; cis-, trans-2,5-bis(hydroxymethyl) 1,4-dioxane; cis-, trans-2,-hydroxymethyl-6-hydroxy-1,4-dioxepane
- 5.2.2 3-Methoxypropane-1,2-diol (3-MPD) 98% (CAS 623-39-2)
- 5.2.3 Butane-1,4 -diol-1,1,2,2,3,3,4,4-(²H)₈ 98% (CAS 74829-49-5)

5.3. Preparation of standard solutions

5.3.1 S0 stock solutions

Accurately weigh 10.0 mg ± 0.05 mg of each standard substance (11.2 mg are weighed for the CycDs, corresponding to 89.3 % purity) and transfer them to a 10 mL volumetric flask (one for each). Add exactly 10 mL of ethanol and mix thoroughly. The concentration of this solution is 1000 ng/μL.

5.3.2 S1 working solutions

¹ Solvay Alkali GmbH no longer provides the standard mixture; solutions of the mixture may be obtained from the BfR. Federal Institute for Risk Assessment, Thielallee 88-92, D-14195 Berlin. www.bfr.bund.de; poststelle@bfr.bund.de

i(1) Bononi, M., Favale, C., Lubian, E., Tateo F. (2001)
A new method for the identification of cyclic diglycerols in wine
J. Int. Sci. Vigne Vin. 35, 225-229

**COMPENDIUM OF INTERNATIONAL ANALYSIS OF METHODS -
OIV**

3-Methoxypropane-1,2-diol and Cyclic Diglycerols

Volumetrically transfer 1000 µL of the S0 stock solution (6.3.1) to a 10 mL volumetric flask, dilute the contents to volume with ethanol, thoroughly stopper the flask and invert to mix. The concentration of this solution is 100 ng/µL.

5.3.3 S2 working solutions

Volumetrically transfer 100 µL of the S0 stock solution (6.3.1) to a 10 mL volumetric flask, dilute the content to volume with ethanol, thoroughly stopper the flask and invert to mix. The concentration of this solution is 10 ng/µL.

Overview of required standard solutions:

CycDs mixture (6 components)

Solution	Concentration	
S0	1000	ng/µL
S1	100	ng/µL

3-Methoxypropane-1,2-diol (3-MPD)

Solution	Concentration	
S0	1000	ng/µL
S1	100	ng/µL
S2	10	ng/µL

1,4 Butane-1,4-(²H)₈ (internal standard IS)

Solution	Concentration	
S0	1000	ng/µL
S1	100	ng/µL

5.4. Preparation of the matrix calibration curve

Matrix-matched calibration solutions are prepared in an uncontaminated wine. It is necessary to analyze this wine first to check that it is not contaminated with 3-MPD or CycDs. If the concentrations of the analytes in the sample are outside the range of the calibration curve, additional levels must be prepared. To ensure that the internal standard does not interfere with any wine components, a blank should be included.

**COMPENDIUM OF INTERNATIONAL ANALYSIS OF METHODS -
OIV
3-Methoxypropane-1,2-diol and Cyclic Diglycerols**

Table 1. Pipetting scheme of matrix calibration

Matrix calibration level		Spike μ l	Volume C Wine C Wine		
			ml	μ g/L	mg/L
Blank	IS	-	10	0	0
	3-MPD	-			
	CycDs	-			
ML0	IS	100	S1 10	1000	1.00
	3-MPD	-			
	CycDs	-			
ML1	IS	100	S1 10	1000	1.00
	3-MPD	100	S2	100	0.10
	CycDs	50	S1	500	0.50
ML2	IS	100	S1 10	1000	1.00
	3-MPD	25	S1	250	0.25
	CycDs	100	S1	1000	1.00
ML3	IS	100	S1 10	1000	1.00
	3-MPD	50	S1	500	0.50
	CycDs	20	S0	2000	2.00
ML4	IS	100	S1 10	1000	1.00
	3-MPD	100	S1	1000	1.00
	CycDs	30	S0	3000	3.00
ML5	IS	100	S1 10	1000	1.00
	3-MPD	200	S1	2000	2.00
	CycDs	40	S0	4000	4.00

6. Apparatus

- 6.1 Analytical balance. ± 0.0001 g readability.
- 6.2 Lab centrifuge (at least 4000 rpm/min)
- 6.3 Gas chromatograph.-With mass spectrometric detector, split-splitless injector,
- 6.4 Diverse precision pipettes and volumetric flasks
- 6.5 Pasteur pipettes
- 6.6 40 mL centrifugation vials
- 6.7 GC-vials (1.5 –2.0 mL)
- 6.8 Thermostat

6.9 Shaking machine

7. Sampling

Wine samples for the analysis should be taken in a sufficient size. Volume needed for one test sample is 10 mL. The wine used for the preparation of the matrix-calibration (5.4) shall be free of analyte.

8. Procedure

8.1. Extraction

Add 100 µL internal standard solution S1 (6.3.2) to 10 mL wine to a suitable centrifugation vial e.g. 40 mL. (This corresponds to a concentration of 1 mg/L butane-1,4-(²H)₈). Carefully add 10 g of K₂CO₃ and mix. Take care during this addition as heat is produced due to the release of CO₂. After cooling the solution to approximately 20 °C in a water bath, add 1 mL diethyl ether. Homogenise the mixture for 5 minutes using a vertical-shaking machine. Centrifuge the vials at 4000 rpm for 5 min. For better removal of the organic phase, the extract can be partially transferred into a vial with a smaller diameter. Using a Pasteur pipette, transfer the upper organic phase, composed of diethyl ether and ethanol, into a GC vial. Add approximately 120 mg of molecular sieve into the vial. Close the vial, leave for at least 2 h and shake well from time to time. The clear supernatant is transferred to a second GC vial for the GC-MS analysis.

8.2. GC-MS Analysis

Specific parameters for the GC-MS analysis are provided below. Alternative systems may be used, if they provide a similar chromatographic performance and adequate sensitivity. The chromatographic system must be able to separate the internal standard from phenylethanol, a potential interference.

Typical GC conditions

Gas chromatograph: HP 5890 or equivalent

DB-Wax (J&W) column 60 m, 0.32 mm internal diameter, 0.25 µm film thickness, 2 m capillary containment same dimensions or equivalent

Carrier gas: H₂

Flow: Pressure 60 k Pa column head

Temperature program:

90° C, 2 min., ramp at 10°C/min. up until 165° C, held for 6 min., ramp at 4° C/min to 250°C, held for 5 min.

Injection temperature: 250° C; Injected volume; 2 µL, 90 sec splitless for 90 s.

**COMPENDIUM OF INTERNATIONAL ANALYSIS OF METHODS -
OIV
3-Methoxypropane-1,2-diol and Cyclic Diglycerols**

Specific MS conditions

Mass spectrometer: Finnigan SSQ 710 or equivalent

Transfer line: 280° C

Source: 150° C

MS detection:

window 1.: 0-25 min.:

14.3 min. 3-MPD: m/z 75, m/z 61

16.7 min IS: m/z 78, m/z 61

Acquisition time for each mass is 250 μ s (dwell time).

Monitor for m/z 91 the separation of the internal standard (IS) peak from phenylethanol, which also produces a fragment m/z 78.

window 2. 25-40 min.:

32-34.5 min. CycDs: m/z 57, m/z 117

Acquisition time for each mass is 250 μ s (dwell time).

It has been observed that the analysis may degrade chromatographic column. In particular, the injection of the high boiling CycDs mixture is suspected to cause irreversible damage. Injections of reference standard solutions should be avoided; analysis should be restricted to salted-out solutions with low analyte concentrations. In addition it is recommended to use a 1-2 m pre column in order to protect the analytical column. Nevertheless, the analytical column has to be considered as a consumable and must be replaced quite regularly.

9. Evaluation

9.1. Identification

Record the relative retention time of each analyte to the IS. Calculate the mean relative retention time of the analytes in the calibration standards. The relative retention time of the analyte should be the same as that of the standard within a margin of ± 0.5 %. As a confirmation criterion, an ion ratio can be calculated for each analyte from the selected ion monitoring. This ratio is 117/57 for CycDs, 75/61 for 3-MPD and 78/61 for the IS. The ratio should be within ± 20 % of that which is found in the spiked sample. Confirmation of the identity of substances by full scan using ions can also be used.

9.2. Quantification

The quantification is done by a matrix calibration curve prepared according to appropriate section. The analyte/IS area ratios of the indicated mass ratios are correlated by linear regression against the concentration of the analyte. Quantification of the CycDs is achieved by summing the peak area of all six peaks and calculating the total content, to allow for other distributions of the six

characteristic CycDs than in the standard. The following m/z values are used for quantification:

3-MPD:	m/z 75
IS:	m/z 78
CycDs:	m/z 117

9.3. Expression of results

Results should be expressed in mg/L for 3-MPD and CycDs with two decimals (e.g. 0.85 mg/L).

9.4 Limit of Detection and limit of quantification

The limit of detection (LD) and the limit of quantification (LQ) depend on the individual measurement conditions of the chemical analysis and are to be determined by the user of the method.

The limit of detection (LD) and the limit of quantification (LQ) were estimated using the instrumentation and conditions mentioned exemplarily above (s. 8) following the instructions in the resolution OENO 7-2000 (E-AS1-10-LIMDET) "Estimation of the Detection and Quantification Limits of a Method of Analysis". Along the line of the „Logic Diagram for Decision-Making“ in N° 3 the graph approach has to be applied following paragraph 4.2.2. For this purpose a part of the ion trace (m/z) chromatogram is drawn extendedly enclosing a range of a tenfold peak width at mid-height ($w_{1/2}$) of an analyte peak in a relevant part of the chromatogram. Furthermore two parallel lines are drawn which just enclose the maximum amplitude of the signal window.

The distance of these two lines gives h_{max} , expressed in abundance units is multiplied by 3 for LD, by 10 for LQ and finally converted into concentration units by implementing the individual response factor.

3-MPD:

LD: 0,02 mg/l

LQ: 0,06 mg/l

CycDs (sum):

LD: 0,08 mg/l

LQ: 0,25 mg/l

(Note: Since the CD are a mixture of six single compounds with the same response factor - due to their chemical equality - and with h_{max} constant in the relevant part of the chromatogram the LD and LQ for each single compound are one sixth of the figures above)

10. Precision (interlaboratory validation)

Eleven laboratories participated in the collaborative study. The participating laboratories have proven experience in the analysis of the by-products. All of them participated in the pre-trial.

Repeatability (r) and reproducibility (R) and the respective standard deviations (S_r and S_R) were found to be correlated statistically significantly with the concentration of the analytes (ANNEX: **Figures 1 and 2**), r with more than 95% probability and R with more than 99% probability for each of the analytes using the linear regression model.

The actual performance parameters can be calculated by:

3-MPD

$$S_r = 0,060 x$$

$$S_R = 0,257 x$$

$$x = \text{concentration of 3-MPD [mg/L]}$$

$$r = 0,169 x$$

$$R = 0,720 x$$

$$x = \text{concentration of 3-MPD [mg/L]}$$

CycDs

$$S_r = 0,082 x$$

$$S_R = 0,092 x + 0,070$$

$$x = \text{concentration of CycDs [mg/L]}$$

$$r = 0,230 x$$

$$R = 0,257 x + 0,197$$

$$x = \text{concentration of CycDs [mg/L]}$$

ANNEX (Interlaboratory Study)

Participants

11 international laboratories participated in the collaborative study (5). The participating laboratories have proven experience in the analysis of the by-products. All of them participated in the pre-trial:

CSL, York, UK
Unione Italiana Vini, Verona, Italy
BfR, Berlin, Germany
BLGL, Würzburg, Germany
Istituto Sperimentale per l'enologia, Asti, Italy
LUA, Speyer, Germany
Labor Dr. Haase-Aschoff, Bad Kreuznach, Germany
CLUA, Münster, Germany
Kantonales Laboratorium, Füllinsdorf, Switzerland
LUA, Koblenz, Germany
ISMAA, S. Michele all Adige, Italy

Samples

In November 2002, participating laboratories were sent 11 wine samples consisting of five sets of blind duplicates and one further single test material. Dry white wines, dry red wines and a sweet red wine were used for test materials. The samples were subjected to homogeneity testing previously (ii).

Data analysis

Statistical analysis was carried out according to the "Protocol for the Design, Conduct and Interpretation of Method Performance Studies" (iii) using a blind duplicate model.

ii(2) Thompson, M. and Wood, R. (1993)
International Harmonised Protocol for the Proficiency Testing of
(Chemical) Analytical Laboratories - J AOAC Int 76, 926-940

(3) Horwitz, W. (1995)
Protocol for the design, conduct and interpretation of method-
performance studies
Pure and Applied Chemistry 67, 331-343

**COMPENDIUM OF INTERNATIONAL ANALYSIS OF METHODS -
OIV**

3-Methoxypropane-1,2-diol and Cyclic Diglycerols

1. Determination of outliers was assessed by Cochran, Grubbs and paired Grubbs tests.
2. Statistical analysis was performed to obtain repeatability and reproducibility data.
3. Horrat values were calculated.

**COMPENDIUM OF INTERNATIONAL ANALYSIS OF METHODS -
OIV
3-Methoxypropane-1,2-diol and Cyclic Diglycerols**

Table 2. Results for 3-MPD

	Sample A White wine	Sample B Red wine ^a	Sample C White wine	Sample F Sweet red wine	Sample G White wine
Mean mg/L	0.30	0.145	0.25	0.48	0.73
Spiked mg/L	0.30	0.12	-	-	0.80
Recovery %	100	121	-	-	91
n	10	10 ^a	10	10	10
nc	1	1 ^a	1	1	1
outliers	2	0	0	1	1
n1	7	9 ^a	9	8	8
r	0.03	-	0.05	0.08	0.13
sr	0.01	-	0.02	0.03	0.05
RSD _r %	3.20	-	7.20	5.80	6.57
Hor	0.30	-	0.60	0.50	0.59
R	0.13	0.13	0.15	0.31	0.59
sR	0.05	0.05	0.05	0.11	0.21
RSD _R %	15.50	32.67	21.20	22.70	28.91
HoR	0.80	1.53	1.10	1.30	1.72

^a Single test sample; n, nc and n1 are single results

mean arithmetic mean of the data used in the statistical analysis

n total number of sets of data submitted

nc number of results (laboratories) excluded due to non-compliance

outliers number of results (laboratories) excluded due to determination as outliers by either Cochran's or Grubbs' tests

n1 number of results (laboratories) retained in statistical analysis

S_r the standard deviation of the repeatability

RSD_r the relative standard deviation of the repeatability (S_rx100/mean)

r repeatability (2.8 x S_r)

Ho_r the Horrat value for repeatability is the observed RSD_r divided by the RSD_r value estimated from the Horwitz equation using the assumption $r = 0.66R$

R reproducibility (between laboratory variation) (2.8 x S_R)

S_R the standard deviation of the reproducibility

RSD_R the relative standard deviation of the reproducibility (S_Rx100/mean)

Ho_R the Horrat value for reproducibility is the observed RSD_R value divided by the RSD_R value calculated from the Horwitz equation

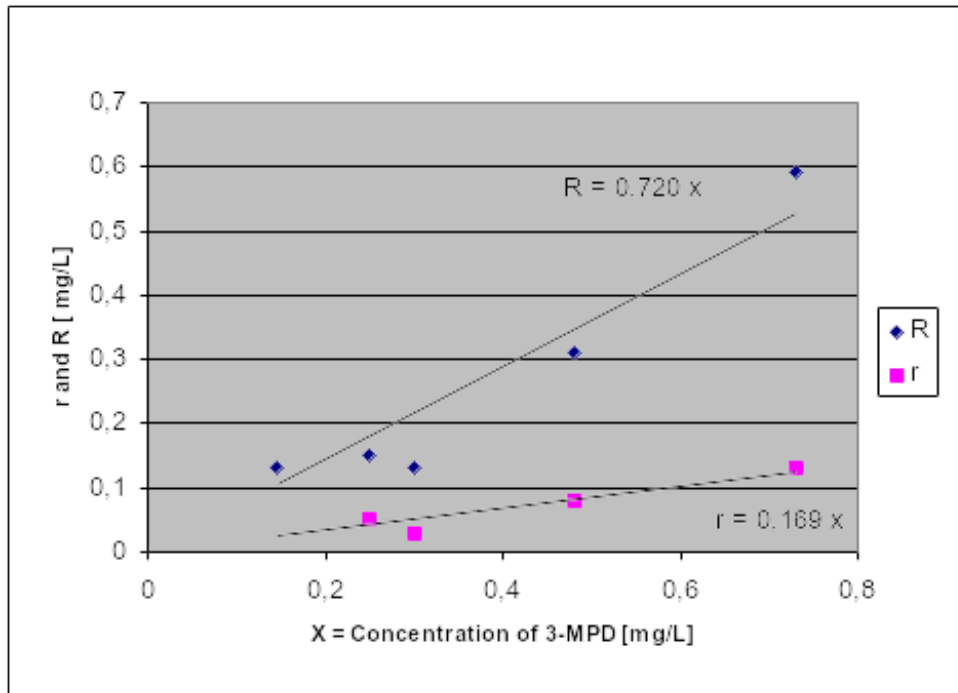

Figure 1. Correlation between 3-MPD concentration and r and R.

**COMPENDIUM OF INTERNATIONAL ANALYSIS OF METHODS -
OIV
3-Methoxypropane-1,2-diol and Cyclic Diglycerols**

Table 3. Results for cyclic diglycerols

	Sample A White wine	Sample B Red wine ^a	Sample D Red wine	Sample F Sweet red wine	Sample G White wine
Mean mg/L	1.55	0.593	0.80	0.96	0.56
Spiked mg/L	1.50	0.53			0.50
Recovery %	103	113			112
n	11	11 ^a	11	11	11
nc	0	0	0	0	0
outliers	2	0	1	2	1
n1	9	11 ^a	10	9	10
r	0.37	-	0.19	0.18	0.15
sr	0.13	-	0.07	0.07	0.05
RSDr %	8.50	-	8.60	6.70	9.30
Hor	0.90	-	0.80	0.60	0.80
R	0.61	0.379	0.39	0.41	0.34
sR	0.22	0.135	0.13	0.15	0.12
RSDR %	14.00	22.827	17.30	15.20	21.50
HoR	0.90	1.319	1.00	0.90	1.20

^a Single test sample; n and nc are single results

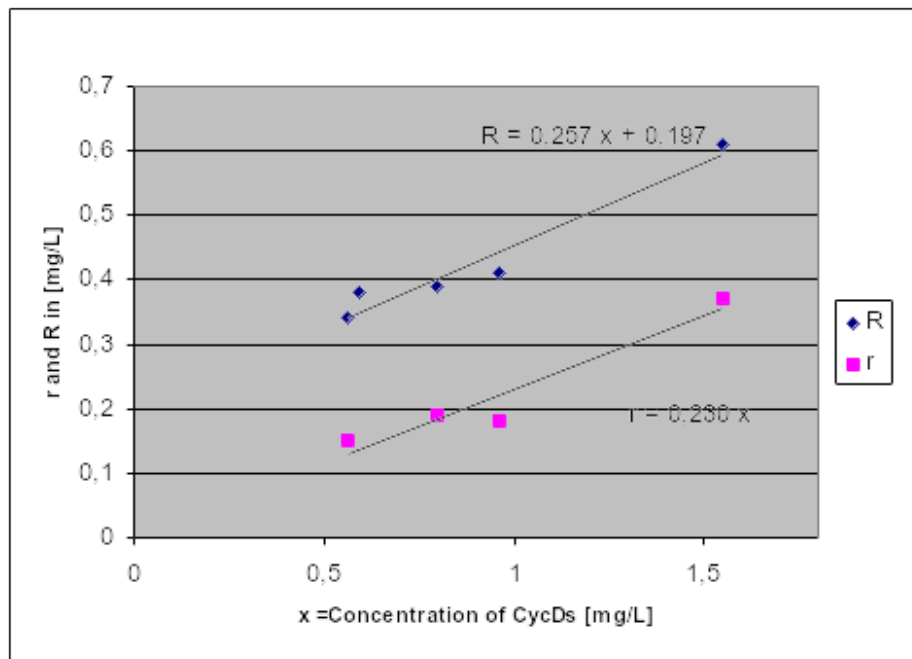

Figure 2. Correlation between CycDs concentration and r and R.

**Determination of releasable 2,4,6-trichloroanisole
in wine by cork stoppers**

OIV/OENO 296/2009

OIV-OENO 623-2018

1 SCOPE:

The method of determination of releasable 2,4,6-trichloroanisole (TCA) by cork stoppers measures the quantity of TCA released by a sample of cork stoppers macerated in a aqueous-alcoholic solution. The aim of this method is to evaluate the risk of releasing by the lot of analyzed cork stoppers and to provide a method for controlling the quality of cork stoppers.

2 PRINCIPLE

The method aims to simulate 2,4,6-trichloroanisole migration phenomena susceptible of being produced between the cork stopper and wine in bottles. Cork stoppers are macerated in a wine or a aqueous-alcoholic solution, until a balance is obtained. The TCA of the head space is sampled from an appropriate part of the macerate by the solid-phase micro-extraction technique (SPME), then analyzed by gas chromatography, with detection by mass spectrometer (or by electron-capture detector).

3 REAGENTS AND PRODUCTS

3.1 White wine with an alcoholic strength ranging between 10 and 12 % vol. (It can be replaced by an aqueous-alcoholic solution with an alcoholic strength of 12 % vol). The wine and/or the aqueous-alcoholic solution must be free of TCA.

3.2 Sodium chloride ≥ 99.5 %

3.3 Internal standard for GC/MS analysis: 2,4,6-trichloroanisole (TCA)-d5 purity $\geq 98\%$ or 2,3,6-trichloroanisole purity $\geq 99\%$.

Internal standard for GC/ECD analysis; 2,6-dibromoanisole purity $\geq 99\%$ or 2,3,6-trichloroanisole purity $\geq 99\%$.

3.4 2,4,6-trichloroanisole (TCA) purity $\geq 99.0\%$

**COMPENDIUM OF INTERNATIONAL ANALYSIS OF METHODS -
OIV
2,4,6-trichloroanisole**

3.5 Absolute ethanol

3.6 Pure de-ionised water void of TCA (Standard EN ISO 3696)

3.7 Aqueous-alcoholic solution at 12 % vol.

Prepared using absolute ethanol (3.5) and de-ionised water void of TCA (3.6).

3.8 Internal standard stock solution (500 mg/L)

Add either 0.050 g of 2,4,6-trichloroanisole-d₅ (or 2,6-dibromoanisole or 2,3,6-trichloroanisole (3.3) to approximately 60 ml of absolute ethanol (3.5). After dissolution, adjust the volume to 100 mL with absolute ethanol (3.5). It can be kept in a glass bottle with a metallic or glasscover.

3.9 Intermediate solution of internal standard (5.0 mg/L)

Add 1 mL of a solution of either 2,4,6-trichloroanisole-d₅ (or 2,6-dibromoanisole or 2,3,6-trichloroanisole) at 500 mg/L (3.8) to approximately 60 mL of absolute ethanol (3.5). Adjust the volume to 100 mL with absolute ethanol (3.5). It can be kept in a glass bottle with a metallic or glass cover.

3.10 Internal standard solution (2.0 µg/L)

Add 40 µL of a solution of either 2,4,6-trichloroanisole-d₅ (or 2,6-dibromoanisole or 2,3,6 trichloroanisole) at 5.0 mg/L (3.9) to approximately 60 mL of absolute ethanol (3.5). Adjust the volume to 100 ml with absolute ethanol (3.5). It can be kept at an ambient temperature in a glass bottle with a metallic or glass cover.

3.11 Stock solution of TCA standard (40 mg/L)

Add 0.020g of 2,4,6-trichloroanisole to approximately 400 ml of absolute ethanol (3.5). Following dissolution, adjust volume to 500 mL with absolute ethanol (3.5).

3.12 Intermediate solution A of TCA standard (80 µg/L)

Add 1 mL of 2,4,6-trichloroanisole solution at 40 mg/L (3.11) to approximately 400 mL of absolute ethanol (3.5). Following dissolution, adjust volume to 500 mL with absolute ethanol (3.5).

3.13 Intermediate solution B of TCA standard (160 ng/L)

Add 1 mL of solution 2,4,6-trichloroanisole at 80 µg/L (3.12) to approximately 400 mL of pure de-ionised water (3.6). Following dissolution, adjust the volume to 500 mL with pure de-ionised water (3.6)

3.14 Use the standard-addition technique to make up a range of standard solutions of TCA. Standard solutions in the range from 0.5 ng/L to 50 ng/L can be used, by making additions with a solution of 2,4,6-trichloroanisole at 160 ng/L

**COMPENDIUM OF INTERNATIONAL ANALYSIS OF METHODS -
OIV
2,4,6-trichloroanisole**

(3.13) to 6 ml of absolute ethanol (3.5). Following dissolution, adjust volume to 50 mL with pure de-ionised water (3.6)

The calibration curve obtained should be evaluated regularly and in any case whenever there is a major change in the GC/MS or GC/ECD systems.

3.15 Carrier gas: Helium, chromatographic purity (≥ 99.9990 %)

4. APPARATUS

4.1 Laboratory glassware

4.1.1 Graduated 100-mL flask

4.1.2 100- μ L microsyringe

4.1.3 Wide-neck glass jar of a capacity adapted to the sample size, closed with a glass or metallic stopper or a material which does not bind TCA.

4.1.4 20-mL glass sample bottle closed with a perforated capsule and a liner with one side Teflon-coated.

4.2 Solid-phase microextraction system (SPME) with a fiber coated with a polydimethylsiloxane film 100 μ m thick

4.3 Heating system for sample bottle (4.1.4)

4.4 Stirring system for sample bottle (4.1.4)

4.5 Gas chromatograph equipped with a "split-splitless" injector and a mass spectrometer detector (MS) or an electron-capture detector (ECD)

4.6 Data-acquisition system

4.7 If required, an automatic sampling and injection system operating with an SPME system

4.8 Capillary column coated with an apolar stationary phase, of the phenylmethylpolysiloxane type (e.g.: 5 % phenyl methylpolysiloxane, 30 m x 0,25 mm x 0,25 μ m film thickness or equivalent.)

5. SAMPLE PREPARATION

The corks are placed whole in a glass closed container. The container capacity (4.1.3), the same as the quantity of wine or aqueous-alcoholic solution (3.1 or 3.7), must be chosen in accordance to the sample size while ensuring that the corks are completely covered and immersed in the maceration container.

Example 1: 20 corks (45x24) mm, in a 1 L container;

Example 2: 50 corks (45x24) mm, in a 2 L container.

Most of the TCA released during maceration of the groups of stoppers is generally derived from a very low percentage of these stoppers. In order to obtain the best representation of a batch of stoppers, a number of appropriate analyses

**COMPENDIUM OF INTERNATIONAL ANALYSIS OF METHODS -
OIV
2,4,6-trichloroanisole**

according to sampling rules and risk with regard to wine contamination should be carried out.

6. OPERATING METHOD

6.1 Extraction

After macerating at ambient temperature for (24 ± 2) hours under laboratory ambient temperature conditions, the maceration is homogenized by inversion. A part of the aliquot of the 10ml maceration solution (5) is transferred to a glass sample bottle (4.1.4)

To increase extraction efficiency and subsequent sensitivity of the method, a quantity sodium chloride (3.2) can be added. The amount of sodium chloride can be adjusted / optimized by the users of this method, depending on the desired level of sensitivity and possible matrix effects that may occur. For example, a quantity of about 3 g of sodium chloride is suggested. 50 μ L of the internal standard solution at 2.0 μ g/L (3.10) are immediately added, then the bottle is closed using a perforated metal capsule fitted with a silicone / Teflon-coated liner. The capsule is crimped. The contents of the bottle are homogenized for 10 minutes by mixing using a stirring system (4.4) or by using an automatic system (4.7).

The bottle containing the sample is placed in the heating system (4.3) set to $35 \text{ }^\circ\text{C} \pm 2 \text{ }^\circ\text{C}$, with stirring (4.4). The extraction of the headspace is carried out using the SPME system (4.2) for at least 15 minutes.

6.2 Analysis

The fiber is then desorbed at $260 \text{ }^\circ\text{C}$ for at least 2 minutes in the injector of a gas chromatograph, in splitless mode (4.5). The separation is carried out using a capillary column with a non-polar stationary phase (4.8). The carrier gas is helium with a constant flow of 1 ml/min. A temperature program from $35 \text{ }^\circ\text{C}$ (for 3 min) to $265 \text{ }^\circ\text{C}$ (at $15 \text{ }^\circ\text{C}/\text{min}$) is given as an example.

6.3 Detection and quantification

Detection and quantification are carried out by mass spectrometry with a selection of specific ions. For example, the following ion ratio is suggested:

**COMPENDIUM OF INTERNATIONAL ANALYSIS OF METHODS -
OIV
2,4,6-trichloroanisole**

<i>Analysis in SIM mode</i>	<i>Analyte</i>	<i>Interesting ions for detection (m/z):</i>	<i>Ion Quantification (m/z) :</i>
	2,4,6-TCA	195, 210, 212	195
	(2,4,6-TCA)-d ₅	199, 215, 217	215
	2,3,6-TCA	195, 210, 212	212

<i>Analysis in tandem mode (MS/MS)</i>	<i>Analyte</i>	<i>Parent ions (m/z):</i>	<i>Daughter ion (m/z) :</i>
	2,4,6-TCA	212	169, 197
		196	167, 169
	(2,4,6-TCA)-d ₅	217	171, 199

For the determination of ECD, identify the analyte and internal standard (2,6-dibromoanisole or 2,3,6 trichloroanisole) in the chromatogram, by comparing the retention time of the sample peak corresponding to that of the standard solution peak.

7. CALCULATIONS

The area of the chromatographic peak obtained for the 2,4,6-trichloroanisole is corrected by the area obtained for the chromatographic peak of the internal standard. The content in 2,4,6-trichloroanisole of each sample is obtained using a calibration curve. The points on this curve are obtained by tracing the relative responses of the 2,4,6-trichloroanisole/internal standard, obtained for aqueous-alcoholic solutions (3.7) containing known concentrations of 2,4,6-trichloroanisole, as a function of the concentrations of these solutions (3.14).

The results are given in ng/L of TCA present in the maceration, rounded off to the nearest 0.1 ng/L.

8. CHARACTERISTICS OF THE METHOD

As an indication, the detection limit of the analysis of the macerations must be lower than 0.5 ng/L, and the quantification limit close to 1 ng/L. The coefficient of variation is lower than 5% for 5 ng/L, when the selected internal standard is the deuterated analogue TCA-d₅.

**COMPENDIUM OF INTERNATIONAL ANALYSIS OF METHODS -
OIV
2,4,6-trichloroanisole**

An interlaboratory trial was carried out in order to validate the method. This interlaboratory trial was not carried out according to the OIV protocol and the validation parameters mentioned in the FV 1224.

9. BIBLIOGRAPHY

HERVÉ E., PRICE S., BURNS G., Chemical analysis of TCA as a quality control tool for natural corks. *ASEV Annual Meeting*. 1999.

ISO standard 20752:2007 Cork stoppers — Determination of releasable 2, 4, 6-trichloroanisole (TCA).

FV 1224 - Résultats de l'analyse collaborative Ring test 3-TCA SPME.

Method OIV-MA-AS315-17

Type IV method

**Determining the presence and content of polychlorophenols
and polychloroanisols in wines, cork stoppers, wood and
bentonites used as atmospheric traps**

OIV/OENO 374/2009

1. SCOPE

All wines, cork stoppers, bentonites (absorption traps) and wood.

2. PRINCIPLE

Determination of 2,4,6-trichloroanisole, 2,4,6-trichlorophenol, 2,3,4,6-tetrachloroanisole, 2,3,4,6-tetrachlorophenol, pentachloroanisole and pentachlorophenol by gas chromatography, by injecting a hexane extract of the wine and an ether/hexane extract of the solid samples to be analyzed and internal calibration.

3. REAGENTS

Preliminary remark: all the reagents and solvents must be free of the compounds to be determined listed in 2 at the detection limit.

3.1 Purity of hexane > 99 %

3.2 Purity of ethylic ether > 99 %

3.3 Ether/hexane mixture (50/50; v/v)

3.4 or 2,5-dibromophenol purity \geq 99 %

3.5 Pure ethanol

3.6 Pure deionized water, TCA free, type II in accordance with ISO standard EN 3696

3.7 50 % vol. aqueous-alcoholic solution. Place 100 ml of absolute ethanol (3.<5) in a graduated 200-ml flask (4.9.9), add 200 ml of deionized water (3.6), and homogenize.

3.8 Internal standard:

3.8.1 200 mg/l stock solution. Place 20 mg of internal standard (3.4) in a graduated 100-ml flask (4.9.8), add the 50 % volume aqueous-alcoholic solution (3.7) and homogenize.

**COMPENDIUM OF INTERNATIONAL ANALYSIS OF METHODS -
OIV
Polychlorophenols, Polychloroanisols**

3.8.2 Internal standard solution (2 mg/l). Place 1 ml of the stock solution of internal standard (3.8.1) in a graduated 100-ml flask (4.9.8), add the 50% vol aqueous-alcoholic solution (3.7) and homogenize.

3.8.3 Internal standard solution (20 µg/l). Place 1 ml of stock solution of internal standard (3.8.2) in a 100 ml graduated flask (4.9.8), add with 50 % vol aqueous-alcoholic solution

3.9 Pure products

3.9.1 2,4,6-trichloroanisole: ≥ 99 %, case: 87-40-1

3.9.2 2, 4, 6-trichlorophenol: ≥ 99.8 %, case: 88-06-2

3.9.3 2,3,5,6-tetrachloroanisole: ≥ 99 %, case: 6936-40-9 (note: the product sought in the samples is 2,3,4,6-tetrachloroanisole but is does not exist on the market)

3.9.4 2, 3, 4, 6-tetrachlorophenol: ≥ 99 %, case: 58-90-2

3.9.5 pentachloroanisole: ≥ 99 %, case: 1825-21-1

3.9.6 pentachlorophenol: 99 %, case: 87-86-5

3.10 Reagents for derivatisation - Piridine: acetic anydride (1:0,4) vol.

3.10.1 Piridine: ≥ 99 %

3.10.2 Acetic anydride: ≥ 98 %

3.11 Calibration stock solution at 200 mg/l

In a graduated 100-ml flask (4.9.8), place approximately 20 mg of the pure reference products (3.9.1 to 3.9.6) but whose exactly weight is known (4.7), add absolute ethanol (3.5). Homogenize.

3.12 Intermediate calibration solution at 200 µg/l

In a graduated 100-ml flask (4.9.8) filled with absolute ethanol (3.5), add 100 µl of the calibration stock solution at 200 mg/l (3.11) using the 100-µl micro-syringe (4.9.1) and homogenize.

3.13 Calibration surrogate solution at 4 µg/l

In a graduated 50-ml flask (4.9.7) containing 50 % vol aqueous-alcoholic solution (3.7) add 1 ml of the intermediate calibration solution at 200 µg/l (3.11) using a 1-ml pipette (4.9.6). Add to volume 50 ml with pure ethanol (3.5) and homogenize.

3.14 Calibration solutions. It is possible to prepare various standard solutions with various concentrations by adding, using the 100-µl micro-syringe of (4.9.1), for example 50 µl of the surrogate calibration solution at 4 µg/l (3.12) to 50 ml of wine to enrich it with 4 ng/l of the substances to be determined.

**COMPENDIUM OF INTERNATIONAL ANALYSIS OF METHODS -
OIV
Polychlorophenols, Polychloroanisols**

The same reasoning can be used to prepare calibration solutions of various concentrations, either using aqueous-alcoholic solutions, or wine, or to enrich an extraction medium with a known quantity of pure products.

3.15 Commercially available Bentonite.

4. APPARATUS

4.1 Gas phase chromatograph with Split-splitless injector coupled to an electron capture detector. (It is likewise possible to use a mass spectrometer)

4.2 Capillary tube of non-polar steady-state phénylméthylpolysiloxane type: (0.32 mm x 50 m, thickness of film 0.12 µm or the equivalent)

4.3 Chromatographic conditions, as an example:

4.3.1 Injection in "split-splitless" mode (valve closing time 30 seconds)

4.3.2 Carrier gas flow rate: 30 ml/min including 1 ml in the column Hydrogen U ®² (It is likewise possible to use helium)

4.3.3 Auxiliary gas flow rate: 60 ml/min – Nitrogen with chromatographic purity (≥ 99,9990 %). It is also possible to use argon methane.

4.3.4 Furnace gradient temperature for information purposes:

- from 40 °C to 160 °C at a rate of 2 °C/min
- from 160 °C to 200 °C at a rate of 5 °C/min
- step at 220 °C for 10 min

4.3.5 Injector temperature: 250 °C

4.3.6 Detector temperature: 250 °C

4.4 Acquisition and integration: acquisition is by computer. The peaks of the various compounds identified by comparison with the reference are then integrated.

4.5 Magnetic agitator.

4.6 Vortex with adaptation for 30-ml flask (4.9.3)

4.7 Precision balance to within 0.1 mg

4.8 Manual or electric household grate

4.9 Laboratory equipment:

4.9.1 100-µl micro-syringe

4.9.2 10-µl micro-syringe

4.9.3 30-ml flask closing with a screwed plug and cover with one side

Teflon-coated

4.9.4 10-ml stick pipette graduated 1/10 ml

4.9.5 5-ml stick pipette graduated 1/10 ml

4.9.6 1-ml precision pipette

**COMPENDIUM OF INTERNATIONAL ANALYSIS OF METHODS -
OIV
Polychlorophenols, Polychloroanisols**

- 4.9.7 Graduated 50-ml flask
- 4.9.8 Graduated 100-ml flask
- 4.9.9 Graduated 200-ml flask
- 4.9.10 100-ml separating funnel
- 4.9.11 Pasteur pipettes and suitable propipette pear
- 4.9.12 Household aluminum foil, roll-form.
- 4.9.13 Centrifuge

5. SAMPLE PREPARATION

- 5.1 The stopper is grated (4.8) or cut into pieces (dimension < 3 mm)
- 5.2 Wood is cut with a clipper to obtain pieces (dimension < 3 mm)
- 5.3 The bentonite (3.15) (30 g for example) is spread out over a strip of aluminum foil (4.9.12) of approximately 30 cm x 20 cm and is exposed to the atmosphere to be analyzed for at least 5 days.

6. OPERATING METHOD

- 6.1 Extraction process for solid samples:
 - 6.1.1 Stopper: in a 30-ml flask (4.9.3), place approximately 1 g of grated stopper (5.1) but of a precisely known weight (4.7)
 - 6.1.2 Wood: in a 30-ml flask (4.9.3), place approximately 2 g of wood chips (5.2) but of a precisely known weight (4.7)
 - 6.1.3 Control Bentonite: in a 30-ml flask (4.9.3), place approximately 5 g of bentonite (3.15) but of a precisely known weight (4.7)
 - 6.1.4 Sample bentonite: in a 30-ml flask (4.9.3), place approximately 5 g of bentonite (5.3) of a precisely known weight (4.7)
 - 6.1.5 Add 10 ml (4.9.4) of ether/hexane mixture (3.3)
 - 6.1.7 Add with the micro-syringe (4.9.1) 50 µl of the internal standard solution (3.8.2)
 - 6.1.8 Agitate with the vortex (4.6) for 3 min
 - 6.1.9 Recover the ether/hexane liquid phase in a 30-ml flask (4.9.3)
 - 6.1.10 Repeat the extraction operation on the sample with 2 times 5 ml of ether/hexane mixture (3.3)
 - 6.1.11 Final extract: mix the 3 phases of ether/hexane.
- 6.2 Extraction of the wine and calibration solution
 - 6.2.1 Sample 50 ml of wine or calibration solution (using the graduated flask (4.9.7))
 - 6.2.2 Place them in the 100-ml graduated flask (4.9.8)

**COMPENDIUM OF INTERNATIONAL ANALYSIS OF METHODS -
OIV
Polychlorophenols, Polychloroanisols**

- 6.2.3 Add with the microsyringe (4.9.1) 50 µl of internal standard (3.8.3)
- 6.2.4 Add 4 ml (4.9.5) of hexane (3.1)
- 6.2.5 Carry out the extraction using the magnetic stirrer (4.5) for 5 min.
- 6.2.6 Elutriate into the funnel (4.9.10)
- 6.2.7 Recover the organic phase with the emulsion in a 30-ml flask (4.9.3) and aqueous phase in the 100-ml graduated flask (4.9.8)
- 6.2.8 Repeat the extraction of the wine or calibration solution using 2 ml of hexane (3.1)
- 6.2.9 Carry out the extraction using the magnetic stirrer (4.5) for 5 min.
- 6.2.10 Elutriate into the funnel (4.9.10)
- 6.2.11 Recover the organic phase with the emulsion in the same 30-ml flask mentioned in 6.2.7 (containing the organic phase obtained upon the first extraction)
- 6.2.12 Break the emulsion of the organic phase by centrifugation (4.9.13) by eliminating the lower aqueous phase using a Pasteur pipette (4.9.11) fitted with a propipette pear.
- 6.2.13 Final wine extract and calibration solutions: the residual organic extract

6.3 Analyze:

- 6.3.1 Add final extract (6.1.11 or 6.2.13) 100 µl (4.9.1) of the pyridine acetic anhydride reagent mixture (3.10) for the derivatisation.
- 6.3.2 Mix using a magnetic stirrer (4.5) for 10 min.
- 6.3.3 Inject 2 µl of derivatised final extract (6.3.2) into the chromatograph

7. CALCULATION:

$\text{Concentration of product} = \frac{\text{Product peak area}}{\text{Peak area of internal standard}} * \text{Response factor}$

Response factor = concentration of calibration solution (3.13) * (Peak area of the internal standard / *(Peak area of the pure product in the calibration solution).

Check the calibration by ensuring the response factors +/- 10 %.

8. RESULTS

The results are expressed in ng/l for the wine and ng/g for the cork stoppers, bentonites and wood.

**COMPENDIUM OF INTERNATIONAL ANALYSIS OF METHODS -
OIV
Polychlorophenols, Polychloroanisols**

9. CHARACTERISTICS OF THE METHOD

9.1 Coverage rate

The coverage rate calculated in relation to the quantities added in terms of wood chips, polychloroanisols and polychlorophenols of 115 ng/g is:

- 2,4,6-trichloroanisol: 96 %
- 2,4,6-trichlorophenol: 96 %
- 2,3,4,6-tetrachloroanisol: 96 %
- 2,3,4,6-tetrachlorophenol: 97 %
- pentachloroanisol: 96 %
- pentachlorophenol: 97 %

9.2 Measurement repeatability

Calculated for each product, the uncertainties are as follows:

In a stopper ng/g	Mean	Standard deviation	Repeatability
2,4,6-trichloroanisol	1.2	0.1	0.28
2,4,6-trichlorophenol	26	3.3	9.24
2,3,4,6-tetrachloroanisol	1.77	0.44	1.23
2,3,4,6-tetrachlorophenol	2.59	0.33	0.92
pentachloroanisol	23.3	2.9	8.12
pentachlorophenol	7.39	1.91	5.35

In wood with 23 ng/g	Standard deviation	Repeatability
2,4,6-trichloroanisol	1.9	5.3
2,4,6-trichlorophenol	1.9	5.3
2,3,4,6-tetrachloroanisol	2.6	7.4
2,3,4,6-tetrachlorophenol	3.3	9.3
pentachloroanisol	2.7	7.5
pentachlorophenol	3.6	10.1

In wine with 10 ng/l	Standard deviation	Repeatability
2,4,6-trichloroanisol	0,4	1,1
2,4,6-trichlorophenol	2,1	5,9
2,3,4,6-tetrachloroanisol	0,6	1,7
2,3,4,6-tetrachlorophenol	4	11,2
pentachloroanisol	1,2	3,4
pentachlorophenol	6,5	18,2

**COMPENDIUM OF INTERNATIONAL ANALYSIS OF METHODS -
OIV
Polychlorophenols, Polychloroanisols**

In bentonite with 15ng/g	Standard deviation	Repeatability
2,4,6-trichloroanisol	0,9	2,5
2,4,6-trichlorophenol	4	11,2
2,3,4,6-tetrachloroanisol	1,2	3,4
2,3,4,6-tetrachlorophenol	5,2	14,6
pentachloroanisol	4,3	12,0
pentachlorophenol	12,1	33,9

9.3 Detection limits (DL) and quantification limits (QL) calculated according to the OIV method:

9.3.1 Wood

	DL in ng/g	QL in ng/g
2,4,6-trichloroanisol	0.72	2.4
2,4,6-trichlorophenol	0.62	2.0
2,3,4,6-tetrachloroanisol	0.59	2.0
2,3,4,6-tetrachlorophenol	1.12	3.74
pentachloroanisol	0.41	1.4
pentachlorophenol	0.91	3.1

9.3.2 Bentonite

	DL in ng/g	QL in ng/g
2,4,6-trichloroanisol	0.5	1
2,4,6-trichlorophenol	1	3
2,3,4,6-tetrachloroanisol	0.5	1
2,3,4,6-tetrachlorophenol	1	3
pentachloroanisol	0.5	1
pentachlorophenol	Not det.	Not det.

9.3.3 Stopper

	DL in ng/g	QL in ng/g
2,4,6-trichloroanisol	0.5	1.5
2,4,6-trichlorophenol	1	2
2,3,4,6-tetrachloroanisol	0.5	1.5
2,3,4,6-tetrachlorophenol	1	2
pentachloroanisol	0.5	1.5
pentachlorophenol	1	2

**COMPENDIUM OF INTERNATIONAL ANALYSIS OF METHODS -
OIV
Polychlorophenols, Polychloroanisols**

9.3.4 Wine

	DL in ng/l	QL in ng/l
2,4,6-trichloroanisol	0.3	1
2,4,6-trichlorophenol	1	3
2,3,4,6-tetrachloroanisol	0.3	1
2,3,4,6-tetrachlorophenol	0.3	1
pentachloroanisol	0.5	3
pentachlorophenol	1	3

®² Air Liquide

Analysis of biogenic amines in musts and wines using HPLC

OIV/OENO 346/2009

1. SCOPE

This method can be applied for analysing biogenic amines in musts and wines:

Ethanolamine: up to 20 mg/l
Histamine: up to 15 mg/l
Methylamine: up to 10 mg/l
Serotonin: up to 20 mg/l
Ethylamine: up to 20 mg/l
Tyramine: up to 20 mg/l
Isopropylamine: up to 20 mg/l
Propylamine: normally absent
Isobutylamine: up to 15 mg/l
Butylamine: up to 10 mg/l
Tryptamine: up to 20 mg/l
Phenylethylamine: up to 20 mg/l
Putrescine or 1,4-diaminobutane: up to 40 mg/l
2-Methylbutylamine: up to 20 mg/l
3-Methylbutylamine: up to 20 mg/l
Cadaverine or 1,5-diaminopentane: up to 20 mg/l
Hexylamine: up to 10 mg/l

2. DEFINITION

The biogenic amines measured are:

Ethanolamine: C_2H_7NO – CAS [141 – 43 – 5]
Histamine: $C_3H_9N_3$ - CAS [51 – 45 – 6]
Methylamine: CH_5N – CAS [74 – 89 – 5]
Serotonin: $C_{10}H_{12}N_2O$ – CAS [153 – 98 – 0]
Ethylamine: C_2H_7N – CAS [557 – 66 – 4]
Tyramine: $C_8H_{11}NO$ - CAS [60 – 19 – 5]
Isopropylamine: C_3H_9N - CAS [75 – 31 – 0]
Propylamine: C_3H_9N – CAS [107 – 10 – 8]
Isobutylamine: $C_4H_{11}N$ – CAS [78 – 81 – 9]
Butylamine: $C_4H_{11}N$ – CAS [109 – 73 – 9]
Tryptamine: $C_{10}H_{12}N_2$ – CAS [61 – 54 – 1]

COMPENDIUM OF INTERNATIONAL METHODS OF ANALYSIS-OIV
Biogenic amines

Phenylethylamine: $C_8H_{11}N$ – CAS [64 – 04 – 0]
Putrescine or 1,4-diaminobutane: $C_4H_{12}N_2$ – CAS [333 – 93 – 7]
2-Methylbutylamine: $C_5H_{13}N$ - CAS [96 – 15 – 1]
3-Methylbutylamine: $C_5H_{13}N$ - CAS [107 – 85 – 7]
Cadaverine or 1,5-diaminopentane: $C_5H_{14}N_2$ – CAS [1476 – 39 – 7]
1,6-Diaminohexane: $C_6H_{16}N_2$ – CAS [124 – 09 – 4]
Hexylamine: $C_6H_{15}N$ – CAS [111 – 26 – 2]

3. PRINCIPLE

The biogenic amines are directly determined by HPLC using a C_{18} column after O-phthalaldehyde (OPA) derivatization and fluorimetric detection.

4. REAGENTS AND PRODUCTS

- 4.1 High purity resistivity water ($18M\Omega \cdot cm$)
- 4.2 Dihydrate disodium hydrogenophosphate - purity $\geq 99\%$
- 4.3 Acetonitrile - Transmission minimum at 200 nm - purity $\geq 99\%$
- 4.4 O-phthalaldehyde (OPA) - Application for fluorescence - purity $\geq 99\%$
- 4.5 Disodium tetraborate decahydrate - purity $\geq 99\%$
- 4.6 Methanol - purity $\geq 99\%$
- 4.7 Hydrochloric acid 32 %
- 4.8 Sodium hydroxide pellets - purity $\geq 99\%$
- 4.9 Ethanolamine - Purity $\geq 99\%$
- 4.10 Histamine dichlorhydrate - Purity $\geq 99\%$
- 4.11 Ethylamine chlorhydrate - Purity $\geq 99\%$
- 4.12 Serotonin - Purity $\geq 99\%$
- 4.13 Methylamine chlorhydrate – Purity $\geq 98\%$
- 4.14 Tyramine chlorhydrate - Purity $\geq 99\%$
- 4.15 Isopropylamine purity $\geq 99\%$
- 4.16 Butylamine - Purity $\geq 99\%$
- 4.17 Tryptamine chlorhydrate - purity $\geq 98\%$
- 4.18 Phenylethylamine - Purity $\geq 99\%$
- 4.19 Putrescine dichlorhydrate - Purity $\geq 99\%$
- 4.20 2-Methylbutylamine - Purity $\geq 98\%$
- 4.21 3-Methylbutylamine - Purity $\geq 98\%$
- 4.22 Cadaverine dichlorhydrate - Purity $\geq 99\%$
- 4.23 1-6-Diaminohexane - Purity $\geq 97\%$
- 4.24 Hexylamine - Purity $\geq 99\%$
- 4.25 Nitrogen (maximum impurities: $H_2O \leq 3\text{ mg/l}$; $O_2 \leq 2\text{ mg/L}$; $C_nH_m \leq 0.5\text{ mg/l}$)

4.26 Helium (maximum impurities: $\text{H}_2\text{O} \leq 3 \text{ mg/l}$; $\text{O}_2 \leq 2 \text{ mg/L}$; $\text{C}_n\text{H}_m \leq 0.5 \text{ mg/l}$)

Preparation of reagent solutions:

4.27 Preparation of eluents

Phosphate solution A: Weigh $11.12 \text{ g} \pm 0.01 \text{ g}$ of di-basic sodium phosphate (4.2) in a 50-ml beaker (5.5) on a balance (5.27). Transfer to a 2-litre volumetric flask (5.9) and make up to 2 litres with high purity water (4.1). Homogenize using a magnetic stirrer (5.30) and filter over a $0.45 \mu\text{m}$ membrane (5.17). Put in the 2-litre bottle (5.12).

Solution B: The acetonitrile (4.3) is used directly.

4.28 OPA solution – Daily preparation

Weigh $20 \text{ mg} \pm 0.1 \text{ mg}$ of OPA (4.4) in a 50-ml flask (5.7) on the precision balance (5.27). Make up to 50 ml with methanol (4.6). Homogenize.

4.29 Preparation of the borate buffer (4.29) – Weekly preparation

Weigh $3.81 \text{ g} \pm 0.01 \text{ g}$ of $\text{Na}_2\text{B}_4\text{O}_7 \cdot 10\text{H}_2\text{O}$ (4.5) in a 25-ml beaker (5.6) on the precision balance (5.27). Transfer to a 100-ml volumetric flask (5.8) and make up to 100 ml with demineralised water (4.1). Homogenize with a magnetic stirrer (5.30), transfer to a 150-ml beaker (5.4) and adjust to pH 10.5 using a pH meter (5.28 and 5.29) with 10 N soda (4.8).

4.30 0.1 M hydrochloric acid solution: Put a little demineralised water (4.1) into a 2-litre volumetric flask (5.9). Add 20 ml of hydrochloric acid (4.7) using a 10-ml automatic pipette (5.24 and 5.25)

4.31 Calibration solution in 0.1 M hydrochloric acid

Guideline concentration of the calibration solution - weigh at $\pm 0.1 \text{ mg}$

COMPENDIUM OF INTERNATIONAL METHODS OF ANALYSIS-OIV
Biogenic amines

	Indicative final concentration in the calibration mix in mg/l
Ethanolamine	5
Histamine	5
Methylamine	1
Serotonin	20
Ethylamine	2
Tyramine	7
Isopropylamine	4
Propylamine	2.5
Isobutylamine	5
Butylamine	5
Tryptamine	10
Phenylethylamine	2
Putrescine	12
2- Methylbutylamine	5
3- Methylbutylamine	6
Cadaverine	13
1,6 Diaminohexane	8
Hexylamine	5

The true concentration of the calibration solution is recorded with the batch number of the products used.

Certain biogenic amines being in salt form, the weight of the salt needs to be taken into account when determining the true weight of the biogenic amine.

The stock solution is made in a 100-ml volumetric flask (5.8).

The surrogate solution is made in a 250-ml volumetric flask (5.10).

4.32 1,6 Diaminohexane internal standard

Weigh exactly 119 mg in a 25-ml Erlenmeyer flask (5.1) on a balance (5.26).

Transfer to a 100-ml volumetric flask (5.8) and top up to the filling mark with 0.1 N hydrochloric acid (4.30).

4.33 2-Mercaptoethanol - Purity \geq 99 %.

5. APPARATUS

- 5.1 25-ml Erlenmeyer flasks
- 5.2 250-ml Erlenmeyer flasks
- 5.3 100-ml beakers
- 5.4 150-ml beakers
- 5.5 50-ml beaker
- 5.6 25-ml beaker
- 5.7 50-ml volumetric flasks
- 5.8 100-ml volumetric flasks
- 5.9 2,000-ml volumetric flasks
- 5.10 250-ml volumetric flask
- 5.11 1-litre bottles
- 5.12 2-litre bottle
- 5.13 2-ml screw cap containers suitable for the sample changer
- 5.14 50-ml syringe
- 5.15 Needle
- 5.16 Filter holder
- 5.17 0.45 µm cellulose membrane
- 5.18 0.8 µm cellulose membrane
- 5.19 1.2 µm cellulose membrane
- 5.20 5 µm cellulose membrane
- 5.21 Cellulose pre-filter
- 5.22 1-ml automatic pipette
- 5.23 5-ml automatic pipette
- 5.24 10-ml automatic pipette
- 5.25 Cones for 10-ml, 5-ml and 1-ml automatic pipettes
- 5.26 Filtering system
- 5.27 Balances for weighing 0 to 205 g at ± 0.01 mg
- 5.28 pH meter
- 5.29 Electrode
- 5.30 Magnetic stirrer
- 5.31 HPLC pump
- 5.32 Changer-preparer equipped with an oven

Note: An oven is indispensable, if a changer-preparer is used for injecting several samples one after another. This operation may likewise be done manually) the results may be less precise;

- 5.33 Injection loop
- 5.34 5 µm C₁₈ column, 250 mm × 4 (which must lead to a similar chromatogram as presented in annex B);

- 5.35 Fluorimetric detector
- 5.36 Integrator
- 5.37 Borosilicic glass tube with a stopper and closure cap covered with PTFE (ex Sovirel 15).

6. PREPARATION OF SAMPLES

Samples are previously purged of gas with nitrogen (4.25).

6.1 Filtering

Filter approximately 120 ml of the sample over membrane:

- for a wine: 0.45 μm (5.17),
- for a must or non-clarified wine: 0.45 (5.17) – 0.8 (5.18) – 1.2 (5.19) - 5 μm (5.20) + pre-filter (5.21), pile filters in the following order, the sample pushed by the top: 0.45 μm (5.17) + 0.8 μm (5.18) + 1.2 μm (5.19) + 5 μm (5.20) + prefiltered (5.21)

6.2 Preparation of the sample

Put 100 ml of the sample (6.1) into a 100-ml volumetric flask (5.8);
Add 0.5 ml of 1-6-diaminohexane (4.32) at 119 mg/100 ml using a 1-ml automatic pipette (5.21 and 25);
Draw off 5 ml of the sample using the pipette (5.23 and 5.25); pour this into a 25-ml Erlenmeyer flask (5.1);
Add 5 ml of methanol to this (4.6) using the pipette (5.23 and 5.25);
Stir to homogenize;
Transfer to containers (5.13);
Start the HPLC pump (5.31), then inject 1 μl (5.32 and 5.33)

6.3 Derivatisation

In a borosilicic glass tube (5.37), pour 2 ml of OPA solution (4.28), 2 ml of borate buffer (4.29), 0,6 ml of 2-mercaptoethanol (4.33). Close, mix (5.30). Open and pour 0,4 ml of sample. Close, mix (5.30). **Inject immediately, as the derivative is not stable.** Rinse recipient immediately after injection, due to odour.

Note: Derivatisation can be carried out by an automatic changer-preparer. In this case, the process will be programmed to come close to the proportion of manual derivatisation

6.4 Routine cleaning

Syringe (5.13) and needle (5.14) rinsed with demineralised water (4.1) after each sample;

filter holder (5.16) rinsed with hot water, then MeOH (4.6). Leave to drain and dry.

7. PROCEDURE

Mobile phase (5.31)

- A: phosphate buffer (4.2)

- B: acetonitrile (4.3)

Elution gradient:

time (in mins)	% A	% B
0	80	20
15	70	30
23	60	40
42	50	50
55	35	65
60	35	65
70	80	20
95	80	20

Note: The gradient can be adjusted to obtain a chromatogram close to the one presented in annex B

Flow rate: 1 ml/min;

Column temperature: 35 °C (5.32);

Detector (5.35): Exc = 356 nm, Em = 445 nm (5.30);

Internal calibration

The calibration solution is injected for each series;

Calibration by internal standard;

Calculation of response factors:

$$RF = C_{cis} \times \text{area } i / \text{area } is \times C_{ci}$$

C_{ci} = concentration of the component in the calibration solution and

C_{cis} = concentration of the internal standard in the calibration solution (1-6-diaminohexane).

Area i = area of the product peak present in the sample

Area is = area of the internal standard peak in the sample

Calculation of concentrations:

$$C_{ci} = (XF \times \text{area } i) / (\text{area } is \times RF)$$

Area i = area of the product peak present in the sample

Area is = area of the internal standard peak present in the sample

XF = quantity of internal calibration added to samples for analysis

XF = $119 \times 0.5/100 = 5.95$.

8. EXPRESSION OF RESULTS

Results are expressed in mg/l with one significant digit after the decimal point.

9. RELIABILITY

	r (mg/l)	R (mg/l)
Histamine	$0.07x + 0.23$	$0.50x + 0.36$
Methylamine	$0.11x + 0.09$	$0.40x + 0.25$
Ethylamine	$0.34x - 0.08$	$0.33x + 0.18$
Tyramine	$0.06x + 0.15$	$0.54x + 0.13$
Phenylethylamine	$0.06x + 0.09$	$0.34x + 0.03$
Diaminobutane	$0.03x + 0.71$	$0.31x + 0.23$
2-methylbutylamine et 3-methylbutylamine	$0.38x + 0.03$	$0.38x + 0.03$
Diaminopentane	$0.14x + 0.09$	$0.36x + 0.12$

The details of the interlaboratory trial with regard to reliability of the method are summarised in appendix A.

10. OTHER CHARACTERISTICS OF THE ANALYSIS

The influence of certain wine components: amino acids are released at the beginning of the analysis and do not impede in detection of biogenic amines.

COMPENDIUM OF INTERNATIONAL METHODS OF ANALYSIS-OIV
Biogenic amines

The limit of detection (LOD) and limit of quantification (LOQ) according to an intralaboratory study

	LOD (in mg/l)	LOQ (in mg/l)
Histamine	0,01	0,03
Methylamine	0,01	0,02
Ethylamine	0,01	0,03
Tyramine	0,01	0,04
Phenylethylamine	0,02	0,06
Diaminobutane	0,02	0,06
2-methylbutylamine	0,01	0,03
3-methylbutylamine	0,03	0,10
Diaminopentane	0,01	0,03

11. QUALITY CONTROL

Quality controls may be carried out with certified reference materials, with wines the characteristics of which result from a consensus or spiked wines regularly inserted into analytical series and by following the corresponding control charts.

COMPENDIUM OF INTERNATIONAL METHODS OF ANALYSIS-OIV
Biogenic amines

Annex A

Statistical data obtained from the results of interlaboratory trials
The following parameters were defined during an interlaboratory trial. This trial was carried out by the Oenology Institute of Bordeaux (France) under the supervision of the National Interprofessional Office of Wine (ONIVINS – France).

Year of interlaboratory trial: 1994

Number of laboratories: 7

Number of samples: 9 double blind samples

(Bulletin de l'O.I.V. November-December 1994, 765-766, p.916 to 962) numbers recalculated in compliance with ISO 5725-2:1994.

Types of samples: white wine (BT), white wine (BT) fortified = B1, white wine (BT) fortified = B2, red wine n°1 (RT), red wine fortified = R1, red wine (RT) fortified = R2, red wine n°2 (CT), red wine (CT) fortified = C1 and red wine (CT) fortified = C2. fortified in mg/l.

	HistN	MetN	EthN	TyrN	PhEtN	DiNbut	IsoamN	DiNpen
wine B1	wine BT + 0,5	wine BT + 0,12	wineBT + 0,13	wine BT + 0,36	wine BT + 0,15	wine BT + 0,5	wine BT + 0,28	wineBT + 0,25
wine B2	wine BT + 2	wine BT + 0,40	wine BT + 0,50	wine BT + 1,44	wine BT + 0,60	wine BT + 2	Wine BT + 0,1,74	wine BT + 1,04
wine C1	wine CT + 2	wine CT + 0,1	wine CT + 0,18	wine CT + 0,72	wine CT + 0,15	wine CT + 2	wine CT + 0,29	wine CT + 0,26
wineC2	wine CT + 4	wine CT + 0,41	wine CT + 0,50	wine CT + 2,90	wine CT + 0,58	wine CT + 8	wine CT + 1,14	wine CT + 1,04
wine R1	wine RT + 2	wine RT + 0,14	wine RT + 0,13	wine RT + 1,45	wine RT + 0,19	wine RT + 3	wine RT + 0,0,57	wine RT + 0,51
wine R2	wine RT + 5	wine RT + 0,41	wine RT + 0,50	wine RT + 2,88	wine RT + 0,59	wine RT + 10	wine RT + 2,28	wine RT + 2,08

HistN : histamine, MetN : methylamine, EthN : ethylamine, TyrN : tyramine,
 PhEtN : phenylethylamine, DiNbut : diaminobutane, IsoamN : isoamylamine and
 DiNpen : diaminopentane.

Annex B : Chromatogram model obtained by this method

**COMPENDIUM OF INTERNATIONAL METHODS OF ANALYSIS-OIV
Biogenic amines**

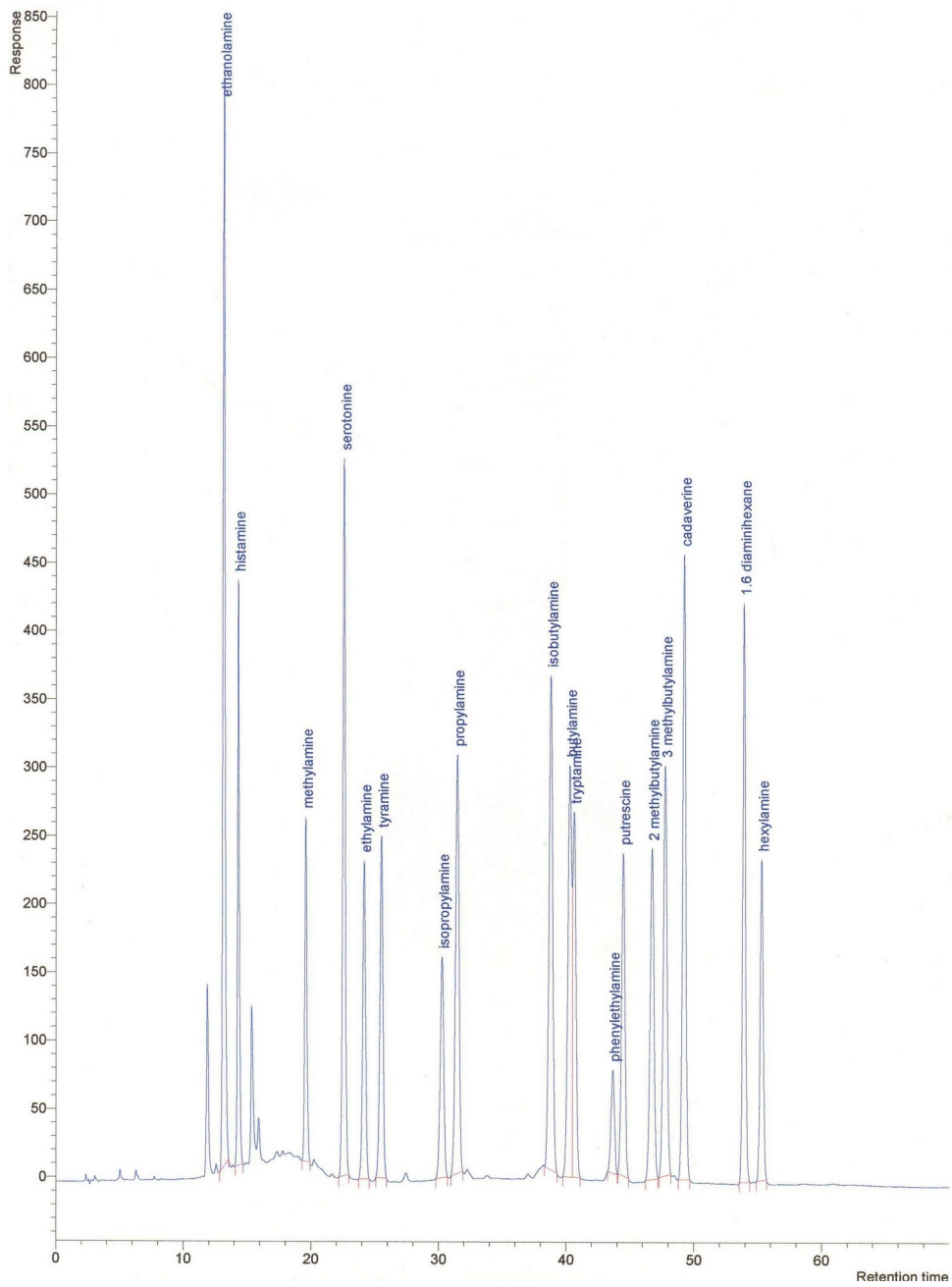

BIBLIOGRAPHY

TRICARD C., CAZABEIL J.-M., SALAGOÏTI M.H. (1991): Dosage des amines biogènes dans les vins par HPLC, *Analisis*, 19, M53-M55.

PEREIRA MONTEIRO M.-J. et BERTRAND A. (1994): validation d'une méthode de dosage – Application à l'analyse des amines biogènes du vin. *Bull. O.I.V.*, (765-766), 916-962.

Determination of glutathione in musts and wines by capillary electrophoresis

OIV/OENO 345/2009

1. Scope

This method makes it possible to determine the glutathione content of musts and wines in a concentration range of 0 to 40 mg/L. It uses capillary electrophoresis (CE) associated with fluorimetric detection (LIF).

2. Principle

The method used, which proceeds by capillary electrophoresis, is an adaptation of the method developed by Noctor and Foyer (1998) to determine non-volatile thiols in poplar leaves using HPLC coupled with fluorimetric detection.

The separation of a mixture's solutes by capillary electrophoresis is obtained by differential migration in an electrolyte. The capillary tube is filled with this electrolyte.

The sample to be separated is injected into one end of the capillary tube. As a result of electrical field activity generated by the electrodes immersed in the electrolyte, the solutes separate due to differences in migration speed and are detected near the other end of the capillary tube in the form of peaks. In given operating conditions, migration times constitute a criterion for the identification of chemical species and the peak area is proportional to the quantity injected.

3. Products and reagents

3.1 List of products

- 3.1.1 Glutathione (GSH, > 98 %)
- 3.1.2 Dithiothreitol (DTT, > 99 %)
- 3.1.3 Anhydrous monobasic sodium phosphate (NaH_2PO_4 , > 99 %)
- 3.1.4 Anhydrous dibasic sodium phosphate (Na_2HPO_4 , > 99 %)
- 3.1.5 2-(N-cyclohexylamino)ethanesulfonic acid (CHES, > 98 %),
- 3.1.6 Monobromobimane (MBB, 97 %)
- 3.1.7 Ethylenediamine tetraacetic acid sodium salt (EDTA, > 99 %)
- 3.1.8 Sodium hydroxide
- 3.1.9 Hydrochloric acid (35 %)
- 3.1.10 Acetonitrile (99.5 %)

3.1.11 Ultra-pure water with a resistance of $>18 \text{ M}\Omega\cdot\text{cm}$.

3.2 List of solutions

All solutions are homogenised prior to use

3.2.1 Electrophoretic buffer: phosphate buffer, 50 mM, pH 7

This buffer is prepared using two solutions - A and B

3.2.1.1 Solution A: 3 mg of anhydrous monobasic phosphate (3.1.3) taken up by 250 ml ultra-pure water (3.1.11)

3.2.1.2 Solution B: 3.55 mg of anhydrous dibasic phosphate (3.1.4) taken up by 250 ml ultra-pure water (3.1.11)

The phosphate buffer is obtained by the addition of 40 ml of solution A (3.2.1.1) and 210 ml of solution B (3.2.1.2) and then made up to 500 ml with ultra-pure water (3.1.11). The buffer's pH is then adjusted to 7 using hydrochloric acid (3.1.9).

3.2.2 Monobromobimane solution (MBB) - 50 mM

25 mg of monobromobimane (MBB) (3.1.6) are taken up by 1,850 μl of acetonitrile (3.1.10).

Stored in the dark at $-20 \text{ }^\circ\text{C}$, this reagent remains stable for three months.

3.2.3 0.1 M sodium hydroxide solution

0.4 g of sodium hydroxide (3.1.8) are put into a 100-ml volumetric flask and taken up by 100 ml of ultra-pure water (3.1.11).

3.2.4 5 M sodium hydroxide solution

20 g of sodium hydroxide (3.1.8) are put into a 100-ml volumetric flask and taken up by 100 ml of ultra-pure water (3.1.11).

3.2.5 CHES buffer: 0.5 M, pH 9.3

2.58 g of 2-(N-cyclohexylamino) ethanesulfonic acid (CHES) (3.1.5) are dissolved in approximately 20ml of ultra pure water (3.1.11). The pH buffer is adjusted to 9.3 by the addition of sodium hydroxide 5 M (3.2.4). The volume is then adjusted to 25 ml with ultra pure water (3.1.11). This buffer is divided between the 1.5-ml test tubes (Eppendorf type) with 1 ml per tube. Stored at $-20 \text{ }^\circ\text{C}$, the CHES aqueous solution may be kept for several months.

3.2.6 Dithiothreitol solution (DTT) - 10 mM

15.4 mg of dithiothreitol (3.1.2) is dissolved in 10 mL of ultra pure water (3.1.11) then this solution is divided in 1.5-ml test tube (Eppendorf type) with 1 ml per tube

Stored at $-20 \text{ }^\circ\text{C}$, this DTT aqueous solution may be kept several months.

4. Apparatus

4.1 Capillary electrophoresis

Capillary electrophoresis equipped with a hydrostatic-type injector is coupled with a laser-induced fluorescence detector with an excitation wavelength similar to the absorption wavelength of the MBB-GSH adduct: e.g.= 390 nm (e.g. Zetalif detector).

4.2 The capillary tube

The total length of the non-grafted silica capillary tube is 120 cm. Its effective length is 105 cm, and its internal diameter is 30 µm.

5. Preparation of samples

The method of determination used consists of the derivatization of the SH functions by the monobromobimane (MBB) (Radkowsky & Kosower, 1986). Samples of musts or non-bottled wines are clarified by centrifugation prior to analysis. Bottled wines are analysed without prior clarification.

Preparation of samples:

In a 1.5-ml test tube (Eppendorf type), put successively:

- 200 µl of the sample,
- 10 µl of the DTT solution (3.2.4) - final concentration of 0.25 mM,
- 145 µl of CHES (3.2.3) - final concentration of 179 mM,
- 50 µl of MBB (3.2.2) - final concentration of 6.2 mM.

After stirring the reagent mixture, the derivatization of thiol functions by the MBB requires a 20-minute incubation period in the dark at ambient temperature. In these analytical conditions, the MBB-SR derivatives thus formed are relatively unstable; CE-LIF determination should be carried out immediately after incubation.

6. Procedure

6.1 Capillary tube preparation

Before being used for the first time and as soon as migration times increase, the capillary tube (4.2) should be treated in the following way:

- 6.1.1. Rinse with 0.1 M sodium hydroxide (3.2.5) for 3 minutes,
- 6.1.2. Rinse with ultra-pure water (3.1.12) for 3 minutes,
- 6.1.3. Rinse with the electrophoretic phosphate buffer (3.2.1) for 3 minutes.

6.2 Migration conditions

6.2.1 Injection of the sample is of the hydrostatic type; 3 s at 50 kPa.
This is followed by injection of 50 μ l electrophoretic buffer (3.2.1) to improve peak resolution (Staking).

6.2.2 Analysis.

A voltage of +30 kV, applied throughout separation, generates a current of 47 μ A. These conditions are reached in 20 s. Separation is carried out at a constant temperature of 21 °C.

6.2.3 Rinsing the capillary tube

The capillary tube should be rinsed after each analysis, successively with:

- 0.1M sodium hydroxide (3.2.5) for 3 minutes,
- ultra-pure water (3.1.12) for 3 minutes,
- electrophoretic phosphate buffer (3.2.1) for 3 minutes.

7. Results

At the concentration ultimately used in the sample, the presence of DTT during derivatization makes it possible to stabilise the unstable functions of thiols that have an alkaline pH and are very easily oxidized by quinines produced by phenolic compound auto-oxidation, but does not break the disulphide bonds. Thus, under these analytical conditions, the reduced glutathione content (GSH) found in a wine with or without addition of 10 mg/l of oxidized glutathione (GSSG) is strictly comparable (Figure 1). This method therefore makes it possible to determine its reduced form alone.

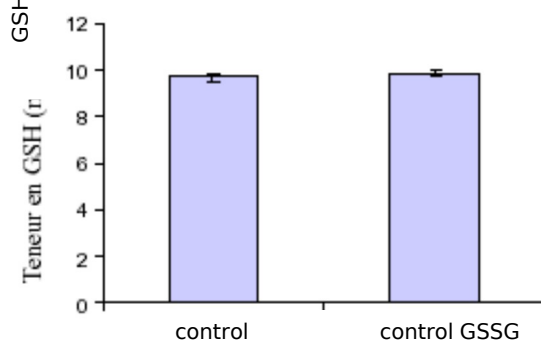

Figure 1: Demonstration of the stability of disulphide bonds according to the conditions of derivatization described. (DTT, ultimately 0.25 mM).

Figure 2 shows the electrophoretic profile of a white grape must sample (Sauvignon) in which cysteine, glutathione, N-acetyl-cysteine and sulphur dioxide are identified. The first peak corresponds to excess reagents (DTT, MBB). The separation of non-volatile thiols takes less than 20 minutes. Only certain peaks could be identified (Figure 2, A) (Newton et al., 1981). These thiols, apart from the sulphur dioxide, are generally present in varying quantities in grapes (Cheynier et al., 1989), fruit and vegetables (Mills et al., 2000).

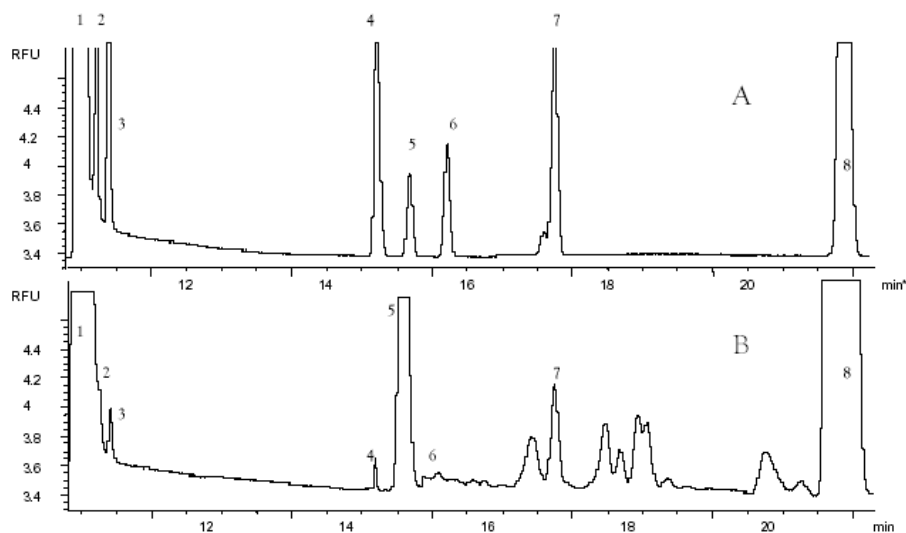

Figure 2: Example of the separation of the known non-volatile thiols in an HCl/EDTA solution (A) 1 and in a grape must (B): DTT; 2: homocysteine; 3: cysteine; 4: Cys-Gly; 5: GSH; 6: g Glu-Cys; ,7: NAC; 8: SO₂ .

In these analytical conditions, MBB-RS adduct retention times are as follows: MBB-homocysteine 10.40 mins; MBB-cysteine 10.65 mins, MBB-GSH 14.14 mins; MBB-NAC 15.41mins; MBB-SO₂ 18.58mins.

8. Characteristics of the method

Certain internal elements of validation were determined, but do not constitute formal validation according to the protocol for the design, conducts and interpretation of methods of analysis performance studies (OIV 6/2000).

Wine is used as a matrix to produce calibration curves and repeatability tests for each compound. Each concentration is calculated based on the average of three

COMPENDIUM OF INTERNATIONAL METHODS OF ANALYSIS-OIV Glutathione

determinations obtained by using the right of the calibration curb regression. Results are expressed in mg/L.

Linear regressions and correlation coefficients are calculated according to the least squares method. The stock solutions of the various thiols are produced from an HCl/EDTA solution, allowing them to be stored at +6 °C for several days with no loss. Successive dilutions of these solutions allow the threshold limits for detection in wine to be estimated, for a signal-to-noise ratio of three or more.

The linearity spectrum varies according to thiols (Table 1).

Table 1: Linearity spectrum, linear regression properties for each thiol in solutions prepared in exactly the same way as that of the glutathione.

	Linearity spectrum	Linear regression	Correlation coefficient
Homocysteine	0 - 15 mg/l	$Y = 0.459X - 0.231$	0.9987
Cysteine	0 - 15 mg/l	$Y = 0.374X - 0.131$	0.9979
Glutathione	0 - 40 mg/l	$Y = 0.583X - 0.948$	0.9966
N-acetyl-cysteine	0 - 10 mg/l	$Y = 0.256X - 0.085$	0.9982

These analytical conditions make it possible to eliminate interference caused by MBB hydrolysis products, unlike the reported findings of other works (Ivanov et al., 2000).

The method's repeatability is calculated on the basis of ten analyses of the same sample of wine. For a thiol concentration of 10 mg/l, the coefficient of variation is 6.0 % for the glutathione; besides this, it is 3.2 % for the homocysteine, 4.8 % for the cysteine and 6.4 % for the N-acetyl-cysteine.

The limit for detecting glutathione is 20 µg/l and the quantification limit is 60 µg/l.

9. Bibliography

- Noctor, G. and C. Foyer, 1998. Simultaneous measurement of foliar glutathione, gamma-glutamylcysteine, and amino acids by high-performance liquid chromatography: comparison with two other assay methods for glutathione, *Analytical Biochemistry*, **264**, 98-110.
- Kosower, N.S., Kosower E. M., Newton G. L., and Ranney H. M., 1979. Bimane fluorescent labels: Labeling of normal human red cells under physiological conditions. *Proc. Natl. Acad. Sci.*, **76** (7), 3382-3386.
- Newton, G.L., R. Dorian, and R.C. Fahey, *Analysis of biological thiols: derivatisation with monobromobimane and separation by reverse-phase high-performance liquid chromatography*. *Anal. Biochem.*, 1981. **114**: p. 383-387.
- Cheyrier, V., J.M. Souquet, and M. Moutounet, 1989. Glutathione content and glutathione to hydroxycinnamic acid ratio in *Vitis vinifera* grapes and musts. *Am. J. Enol. Vitic.*, **40** (4), 320-324.
- Mills, B.J., Stinson C. T., Liu M. C. and Lang C. A., 1997. Glutathione and cyst(e)ine profiles of vegetables using high performance liquid chromatography with dual electrochemical detection. *Journal of food composition and analysis*, **10**, 90-101.
- Ivanov, A.R., I.V. Nazimov, and L. Baratova, 2000. Determination of biologically active low molecular mass thiols in human blood. *Journal of Chromatogr. A.*, **895**, 167-171.

**COMPENDIUM OF INTERNATIONAL ANALYSIS OF
METHODS – OIV
 α -dicarbonyl compounds by HPLC after derivatization**

Method OIV-MA-AS315-20

Type IV method

**METHOD FOR THE DETERMINATION OF α -DICARBONYL
COMPOUNDS OF WINE by HPLC AFTER DERIVATIZATION BY
1,2-DIAMINOBENZENE
OIV/OENO 386A/2010**

1. Introduction

The principal α -dicarbonyl compounds found in wine (Fig 1) are: glyoxal, methylglyoxal, diacetyl and pentane-2,3-dione, but only α -diketones are relatively abundant in wine. Carbonyl compounds exist in all types of wines, particularly after malolactic fermentation and in red wines. In addition, sweet white wines produced with botrytized grapes can contain high levels of glyoxal and methylglyoxal.

Glyoxal: OCH-CHO (ethanedial)

Methylglyoxal: $\text{CH}_3\text{-CO-CHO}$ (2-oxopropanal)

Diacetyl: $\text{CH}_3\text{-CO-CO-CH}_3$ (2,3-butanedione)

2,3-Pentanedione: $\text{CH}_3\text{-CH}_2\text{-CO-CO-CH}_3$

2,3-Hexanedione: $\text{CH}_3\text{-CH}_2\text{-CH}_2\text{-CO-CO-CH}_3$

Figure 1. The principal α -dicarbonyl compounds of wine (2,3-hexanedione is not naturally present in wine but it is used as internal standard).

Dicarbonyl compounds are important in wine for different reasons: their sensory impact, the reactivity with other components of the wine or possible microbiological effects.

**COMPENDIUM OF INTERNATIONAL ANALYSIS OF
METHODS – OIV
 α -dicarbonyl compounds by HPLC after derivatization**

2. Applicability

This method applies to all types of wines (white, red, sweetened or fortified), for dicarbonyl compounds with a content that ranges from 0.05 mg/l to 20 mg/l .

3. Principle

The method is based on the formation of derivatives of the quinoxaline type based on the α -dicarbonyl compounds of the wine with 1,2-diaminobenzene (Figure 2).

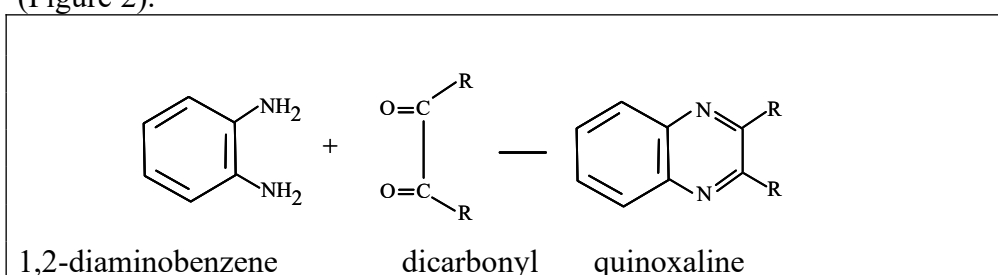

Figure 2 Formation of derivatives.

The reaction takes place directly in the wine at pH 8 and after a reaction time of 3 h at 60°C. The analysis of the derivatives is then carried out directly by high-performance liquid chromatography (HPLC) and detection by UV absorption at 313 nm.

4. Reagents and products

4.1 Dicarbonyl compounds

- 4.1.1 Glyoxal in a solution at 40% (CAS N° 107-22-3)
- 4.1.2 Methylglyoxal in a solution at 40% (CAS N° 78-98-8)
- 4.1.3 Diacetyl, purity > 99% (CAS N° 431-03-8)
- 4.1.4 2,3-Pentanedione, purity > 97% (CAS N° 600-14-6)

**COMPENDIUM OF INTERNATIONAL ANALYSIS OF
METHODS – OIV
 α -dicarbonyl compounds by HPLC after derivatization**

- 4.1.5 2,3-Hexanedione, purity > 90% (CAS N° 3848-24-6)
- 4.2 1,2-Diaminobenzene in powder form, purity > 97%
- 4.3 Water for HPLC (for example microfiltered and with a resistivity of 18.2 M Ω) (CAS N° 95-54-5)
- 4.4 Pure ethanol for HPLC (CAS N° 64-17-5)
- 4.5 Sodium Hydroxide M (CAS N° 1310-73-2)
- 4.6 Pure crystallisable acetic acid (CAS N° 64-19-7)
- 4.7 Solvent A for the analysis by HPLC
To 1 l of water for HPLC (4.3) add 0.5 ml of acetic acid (4.8), mix, degas (for example by sonication)
- 4.8 Solvent B for HPLC
Pure methanol for HPLC (CAS N° 67-56-1)
- 4.9 Aqueous-alcoholic solution at 50% vol.
Mix 50 ml of pure ethanol for HPLC (4.4) with 50 ml of water (4.3)
- 4.10 Solution of internal standard 2,3-hexanedione at 2.0 g/l
Place 40 mg of 2,3-hexanedione (4.2) in a 30-ml flask, dilute in 20 ml of aqueous-alcoholic solution to 50% vol (4.9) and stir until it has completely dissolved.

5. Equipment

- 5.1 High-performance liquid chromatograph with detection by UV absorption (313 nm);
 - 5.1.1 Analytical column filled with 5 μ m octadecyl silica whose dimensions are for example 250 mm x 4.6 mm.
 - 5.1.2 Data acquisition system.
- 5.2 pH measuring apparatus.
- 5.3 Magnetic stirrer.
- 5.4 Balance with a precision of 0.1 mg.
- 5.5 Solvent degasification system for HPLC (for example an ultrasonic bath).
- 5.6 Oven which can be set to 60°C.
- 5.7 Standard laboratory glassware including pipettes, 30-ml screw-cap flasks, and microsyringes.

**COMPENDIUM OF INTERNATIONAL ANALYSIS OF
METHODS – OIV
 α -dicarbonyl compounds by HPLC after derivatization**

6. Preparation of the sample

No specific preparation is necessary.

7. Procedure

Place 10 ml of wine in a 30-ml flask (5.7)

Bring to pH 8 while stirring, with sodium hydroxide M (4.5)

Add 5 mg of 1,2-diaminobenzene (4.2)

Add 10 μ l of 2,3-hexanedione (internal standard) at 2.0 g/L (4.10)

Close the flask using a screw-cap fitted with a Teflon-faced seal

Stir until the reagent has completely disappeared (5.3)

Place in the oven at 60°C for 3 h (5.6)

Cool.

7.1 Optimisation and analytical conditions

The yield of the reaction of the dicarbonyl compounds with the 1-2-diaminobenzene is optimal at pH 8. Solutions of dicarbonyl compounds have been derivatized at 25, 40 or 60°C and then analysed by HPLC according to the protocol described in point 7.2 at different times (Table 1). Diketones require much more reaction time and a higher reaction temperature. The reaction is slower with molecules with longer chains (2,3-pentanedione and 2,3-hexanedione).

In addition, no interference of SO₂ with the formation of quinoxalines was noted during the study of the method.

**COMPENDIUM OF INTERNATIONAL ANALYSIS OF
METHODS – OIV
 α -dicarbonyl compounds by HPLC after derivatization**

Table 1. Effect of reaction time and temperature on the formation of derivatives by diaminobenzene from glyoxal, diacetyl and 2,3-hexanedione

	Temperature (°C)	Reaction time		
		1h	2h	3h
		Recovery rate (%)		
Glyoxal	25	92	93	94
	40	95	97	98
	60	96	98	100
Diacetyl	25	23	77	87
	40	64	89	94
	60	85	100	100
2,3-Hexanedione	25	17	67	79
	40	55	79	88
	60	69	93	100

7.2 Analysis by HPLC

- *Injection.* After cooling, 20 μ l of the reaction medium containing the quinoxalines is directly injected into the HPLC system.
- *Elution programme.* For the separation, the elution programme is presented in Table 2

Table 2. Elution programme for the analysis by HPLC

Time in minutes	solvent A	solvent B
0	80	20
8	50	50
26	25	75
30	0	100
32	0	100
40	100	0
45	80	20

**COMPENDIUM OF INTERNATIONAL ANALYSIS OF
METHODS – OIV
 α -dicarbonyl compounds by HPLC after derivatization**

50

80

20

The flow rate is 0.6 ml/min

- *Separation.* The chromatogram obtained by HPLC is shown in Figure 3.
- *Detection.* The maximum absorbance was studied for all the derivatized dicarbonyl compounds and set at 313 nm as being optimal.
- *Identification of derivatives.* The identification of the derivatives was carried out by comparing the retention times with standard reference solutions. The chromatographic conditions permit a good separation of the peaks in all wines.

7. 2.1 Characteristics of the method by HPLC

Some internal validation methods have been determined but do not constitute a formal validation process according to the protocol governing the planning, the implementing and the interpreting of performance studies pertaining to analysis methods (OIV 6/2000)

- *Repeatability.* The repeatability of the method was calculated using 10 analyses of the same wine (Table 3).

Table 3. Repeatability study and performance of the method

	Average*	Standard deviation	CV (%)
<u>White wine</u>			
Glyoxal	4.379	0.101	2.31
Methylglyoxal	2.619	0.089	3.43
Diacetyl	5.014	0.181	3.62
2,3-Pentanedione	2.307	0.097	4.21
<u>Red wine</u>			
Glyoxal	2.211	0.227	10.30
Methylglyoxal	1.034	0.102	9.91
Diacetyl	1.854	0.046	2.49
2,3-Pentanedione	0.698	0.091	13.09

* Results in mg/l based on 10 analyses of the same wine.

**COMPENDIUM OF INTERNATIONAL ANALYSIS OF
METHODS – OIV
 α -dicarbonyl compounds by HPLC after derivatization**

- *Linearity.* The linearity of the method was tested using standard solutions (using an aqueous-alcoholic solution at 12% vol. as a matrix) (Table 4). The quantitative analysis of the additions of dicarbonyl compounds showed that the method is linear for the four compounds and that its precision is satisfactory.

Table 4. Study of the linearity and recovery tests with standard solutions (water-ethanol at 12% v/v) Value of the correlation coefficient

Glyoxal value ^a peak area ^b	Methylglyoxal value ^a peak area ^b	Diacetyl value ^a peak area ^b	Pentane-2,3-dione value ^a peak area ^b
1			
R = 0.992	R = 0.997	R = 0.999	R = 0.999

- *The recovery* of additions carried out in red and white wines demonstrated the satisfactory performance of the method . Contained in the 92% - 116% range for extreme values

- *The quantification limit* of the dicarbonyl compounds is very low, the best results being obtained with diacetyl, whose detection limit is 10 times lower than that of the other compounds (Table 5).

Table 5. Performance of the method by HPLC for the quantification of dicarbonyl compounds

Limits	detection ^a	determination ^a	quantification ^a
Glyoxal	0.015	0.020	0.028
Methylglyoxal	0.015	0.020	0.027
Diacetyl	0.002	0.002	0.003
2.3-Pentanedione	0.003	0.004	0.006

a: results in mg/l, aqueous-alcoholic solution (10% vol).

**COMPENDIUM OF INTERNATIONAL ANALYSIS OF
METHODS – OIV
 α -dicarbonyl compounds by HPLC after derivatization**

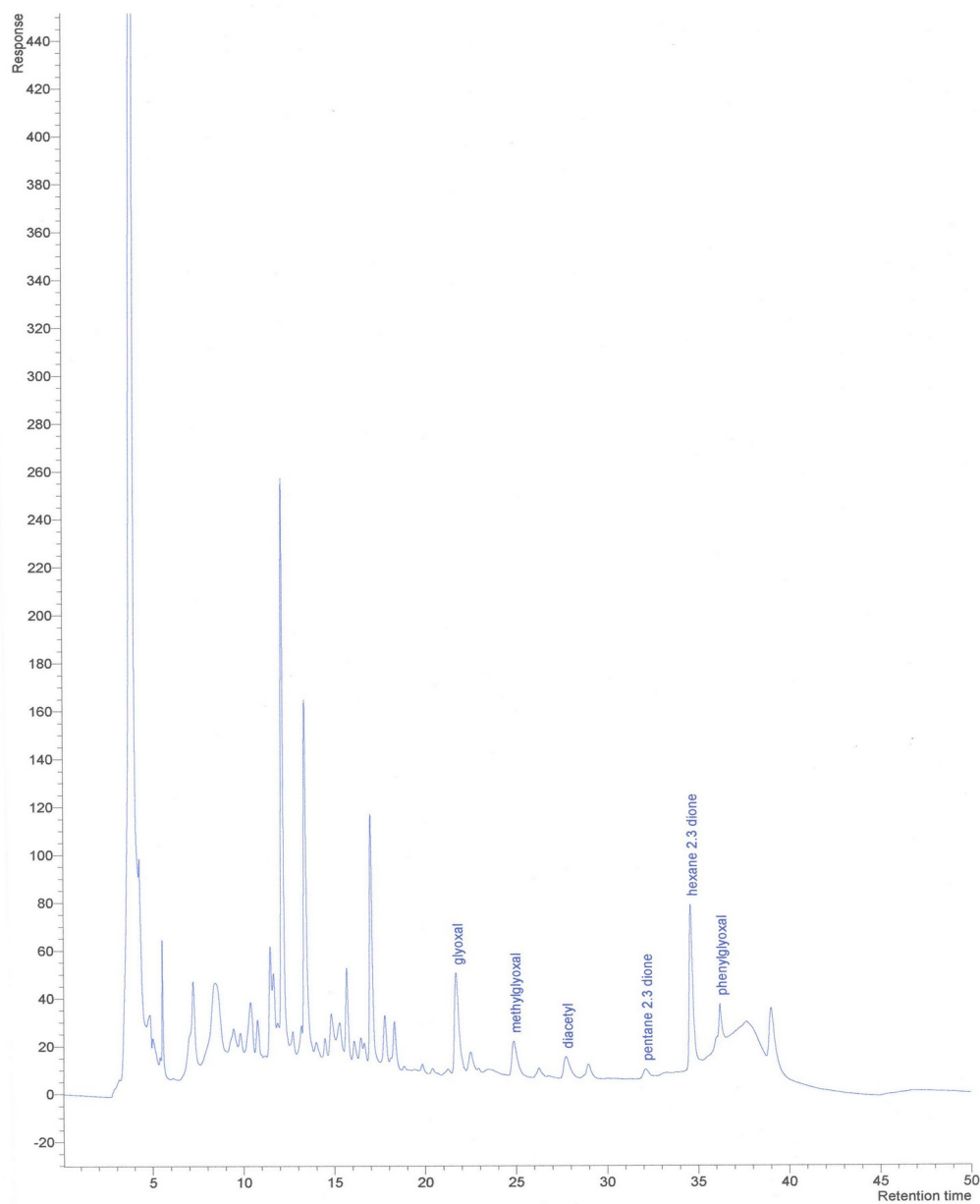

Figure 3. High-performance liquid phase chromatogram of dicarbonyl compounds derivatized by 1,2-diaminobenzene from a white wine, detected by UV at 313 nm. Spherisorb ODS Column 250 mm x 4.6 mm x 5 μ m.

**COMPENDIUM OF INTERNATIONAL ANALYSIS OF
METHODS – OIV
 α -dicarbonyl compounds by HPLC after derivatization**

Bibliography

Bartowski E.J. and Henschke P.A., The buttery attribute of wine – diacetyl – desirability spoilage and beyond. *Int. J. Food Microbiol.* 96: 235-252 (2004).

Bednarski W., Jedrychowski L., Hammond E., and Nikolov L., A method for determination of α -dicarbonyl compounds. *J. Dairy Sci.* 72:2474-2477 (1989).

Leppanen O., Ronkainen P., Koivisto T. and Denslow J., A semiautomatic method for the gas chromatographic determination of vicinal diketones in alcoholic beverages. *J. Inst. Brew.* 85:278- 281 (1979).

Martineau B., Acree T. and Henick-Kling T., Effect of wine type on the detection threshold for diacetyl. *Food Res. Int.* 28:139-143 (1995).

Moree-Testa P. and Saint-Jalm Y., Determination of α -dicarbonyl compounds in cigarette smoke. *J. Chromatogr.* 217:197-208 (1981).

De Revel G., Pripis-Nicolau L., Barbe J.-C. and Bertrand A., The detection of α -dicarbonyl compounds in wine by the formation of quinoxaline derivatives. *J. Sci. Food Agric.* 80:102-108 (2000).

De Revel G. and Bertrand A., Dicarbonyl compounds and their reduction products in wine. Identification of wine aldehydes. *Proc. 7th Weurman Flavour Research Symp, Zeist, June*, pp 353-361 (1994).

De Revel G. and Bertrand A., A method for the detection of carbonyl compounds in wine: glyoxal and methylglyoxal. *J. Sci. Food Agric.* 61:267-272 (1993).

Voulgaropoulos A., Soilis T. and Andricopoulos N., Fluorimetric determination of diacetyl in wines after condensation with 3,4-diaminoanisole. *Am. J. Enol. Vitic.* 42:73-75 (1991).

Gilles de Revel et Alain Bertrand Analyse des composés α -dicarbonyles du vin après dérivation par le 2,3-diaminobenzène OIV FV 1275

**COMPENDIUM OF INTERNATIONAL ANALYSIS OF
METHODS – OIV
 α -dicarbonyl compounds by GC after derivatization**

**METHOD FOR THE DETERMINATION OF α -
DICARBONYL COMPOUNDS OF WINE BY GC AFTER
DERIVATIZATION BY 1,2-DIAMINOBENZENE
OIV/OENO 386B/2010**

Method OIV-MA-AS315-21

Type IV method

1. Introduction

The principal α -dicarbonyl compounds found in wine (Fig 1) are: glyoxal, methylglyoxal, diacetyl and 2,3-pentanedione, but only α -diketones are relatively abundant in wine. Carbonyl compounds exist in all types of wines, particularly after malolactic fermentation and in red wines. In addition, sweet white wines produced with botrytized grapes can contain high levels of glyoxal and methylglyoxal.

Glyoxal: OCH-CHO (ethanedial)

Methylglyoxal: $\text{CH}_3\text{-CO-CHO}$ (2-oxopropanal)

Diacetyl: $\text{CH}_3\text{-CO-CO-CH}_3$ (2,3-butanedione)

2,3-pentanedione: $\text{CH}_3\text{-CH}_2\text{-CO-CO-CH}_3$

2,3-hexanedione: $\text{CH}_3\text{-CH}_2\text{-CH}_2\text{-CO-CO-CH}_3$

Figure 1. The principal α -dicarbonyl compounds of wine (2,3-hexanedione is not naturally present in wine but it is used as internal standard).

COMPENDIUM OF INTERNATIONAL ANALYSIS OF METHODS – OIV

α -dicarbonyl compounds by GC after derivatization

Dicarbonyl compounds are important in wine for different reasons: their sensory impact, the reactivity with other components of the wine or possible microbiological effects.

2. Applicability

This method applies to all types of wines (white, red, sweetened or fortified), for carbonyl derivatives content ranging from 0.05 mg/L and 20 mg/L.

3. Principle

The method is based on the formation of derivatives of the quinoxaline type based on the α -dicarbonyl compounds of the wine with 1,2-diaminobenzene (Figure 2).

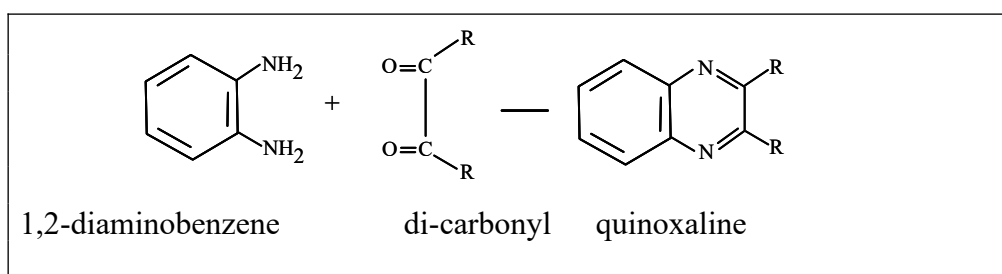

Figure 2 Formation of derivatives.

The reaction takes place directly in the wine at pH 8 and after a reaction time of 3 h at 60°C. The analysis of the derivatives is then carried out after extraction of the derivatives by dichloromethane and analysis by gas chromatography with detection by mass spectrometry (GC-MS) or using a nitrogen-specific detector.

4. Reagents and products

4.1 Dicarbonyl compounds

4.1.1 Glyoxal in a solution at 40% (CAS n° 107-22-3)

4.1.2 Methylglyoxal in a solution at 40% (CAS n° 78-98-8)

4.1.3 Diacetyl, purity > 99% (CAS n° 431-03-8)

4.1.4 2,3-Pentanedione, purity > 97% (CAS n° 600-14-6)

4.1.5 2,3-Hexanedione, purity > 90% (CAS n° 3848-24-6)

4.2 1,2-Diaminobenzene in powder form, purity > 97% (CAS n° 95-54-5)

**COMPENDIUM OF INTERNATIONAL ANALYSIS OF
METHODS – OIV
 α -dicarbonyl compounds by GC after derivatization**

4.3 Water for HPLC (for example microfiltered and with a resistivity of 18.2

M Ω)

4.4 Pure ethanol for HPLC (CAS n° 64-17-5)

4.5 Sodium hydroxide M. (CAS n° 1310-73-2)

4.6 Sulphuric acid 2M (CAS n° 7664-93-9)

4.7 Dichloromethane (CAS n° 75-09-2)

4.8 Anhydrous sodium sulphate (CAS n° 7757-82-6)

4.9 Aqueous-alcoholic solution at 50% vol .

Mix 50 ml of pure ethanol for HPLC (4.4) with 50 ml of water (4.3)

4.10 Solution of internal standard 2,3-hexanedione at 2.0 g/L

Place 40 mg of 2,3-hexanedione (4.2) in a 30-ml flask, dilute in 20 ml of aqueous-alcoholic solution to 50% vol (4.9) and stir until it has completely dissolved.

4.11 Anhydrous sodium sulphate (CAS n° 7757-82-6)

5. Equipment

5.1 Gas chromatograph with detection by mass spectrometry (GC-MS) or a nitrogen-specific detector.

5.1.1 Relatively polar, polyethylene glycol capillary column (CW 20M, BP21 etc.) with the following characteristics (as an example): 50 m x 0.32 mm x 0.25 μ m.

5.1.2 Data acquisition system.

5.2 pH measuring apparatus

5.3 Magnetic stirrer

5.4 Balance with a precision of 0.1 mg.

5.5 Oven which can be set to 60°C

5.6 Standard laboratory glassware including pipettes, screw-cap flasks, and microsyringes.

6. Preparation of the sample

No specific preparation is necessary

7. Procedure

Place 50 ml of wine in a flask (5.6)

**COMPENDIUM OF INTERNATIONAL ANALYSIS OF
METHODS – OIV
 α -dicarbonyl compounds by GC after derivatization**

Bring to pH 8 while stirring, with sodium hydroxide M (4.5)

Add 25 mg of 1,2-diaminobenzene (4.2)

Add 50 μ l of 2,3-hexanedione (internal standard) at 2.0 g/L (4.10)

Close the flask using a screw-cap fitted with a Teflon-faced seal

Stir until the reagent has completely disappeared (5.3)

Place in the oven at 60°C for 3 h (5.5)

Cool.

7.1 Optimisation and analytical conditions (this study was carried out by HPLC analysis, see this method)

The yield of the formation of derivatives of the dicarbonyl compounds with the 1-2-diaminobenzene is optimal at pH 8 at 60°C after three hours of reaction time

In addition, no interference of SO₂ with the formation of quinoxalines was noted during the study of the method.

7.2 Analysis by GC

7.2.1 Extraction of quinoxalines

- The reaction medium prepared in 7 is brought to pH 2 using H₂SO₄ 2M (4.6);

- Extract 2 times using 5 ml of dichloromethane (4.7) by magnetic stirring for 5 minutes;

- Decant the lower phase each time;

- Mix the two solvent phases;

- Dry on approximately 1 g of anhydrous sodium sulphate (4.11);

- Decant.

7.2.2 Chromatographic analysis (given as an example)

- *Detection.* For the analysis by GC-MS, a Hewlett Packard HP 5890 gas-phase chromatograph was coupled with Chemstation software and an HP 5970 mass spectrometer (electronic impact 70eV, 2.7 kV),

Note: It is also possible to use a nitrogen-specific detector

- *Column.* The column is a BP21 (SGE, 50 m x 0.32 mm x 0.25 μ m).

- *Temperatures.* The temperature of the injector and the detector are respectively 250°C and 280°C; that of the oven is held at 60°C for 1min,

**COMPENDIUM OF INTERNATIONAL ANALYSIS OF
METHODS – OIV
 α -dicarbonyl compounds by GC after derivatization**

then programmed to increase at a rate of 2°C/min to 220°C and the final isothermal period lasts 20 min.

- *Injection.* The volume injected is 2 μ l and the splitless time of the injector valves is 30s.

7.2.3 Analysis of quinoxalines formed

- *Separation.* The chromatogram of the derivatives from a wine obtained with 1,2-diaminobenzene, using selected-ion monitoring (SIM), is shown in Figure 3. Good separations were obtained with all types of wines (white, red, sweetened or fortified), and even with fermenting musts.

- *Identification of the peaks.* GC-MS was used to identify the dicarbonyl compounds derivatized from the wine based on the total ion current method (scan) which is used to obtain the mass spectra of derivatized quinoxalines and to compare them with those recorded in the library; in addition, the retention times were compared with those for pure compounds treated in the same way. Table 1 shows the principal ions of the mass spectra for the derivatized dicarbonyl compounds obtained.

- *Determination.* The quantitative determination of the dicarbonyl compounds is performed with the SIM method, by selecting ions $m/z = 76, 77, 103, 117, 130, 144, 158$ and 171 . The ions $m/z = 76$ and 77 are used for the quantification and the others as qualifiers, i.e. glyoxal: ions $m/z = 103$ and 130 , methylglyoxal: ions $m/z = 117$ and 144 , diacetyl: ions $m/z = 117$ and 158 , 2,3-pentandione: ions $m/z = 171$ and 2,3-hexanedione: ions $m/z = 158$ and 171 .

7.2.4 Characteristics of the method

Some elements of internal validation were determined, but this is not a formal validation according to the protocol governing the planning, the implementing and the interpreting of the performance studies pertaining to the analysis methods (OIV 6/2000)

- *Repeatability.* The repeatability of the GC-MS-SIM method shows coefficients of variation ranging between 2 and 5% for the four dicarbonyl compounds;

- *Recovery rate.* The quantities added to a wine were recovered with a recovery rate ranging between 92 and 117%;

**COMPENDIUM OF INTERNATIONAL ANALYSIS OF
METHODS – OIV
 α -dicarbonyl compounds by GC after derivatization**

- *Linearity*. Linear correlations were obtained in concentrations ranging from 0.05 to 20 mg/l.
- *Limit of detection*. The limit of detection of most of the derivatized dicarbonyl compounds using wine as a matrix is 0.05 mg/l

Table 1. Mass spectra (ion m/z and abundance of the ion in relation to that of the base peak) of derivatives of dicarbonyl compounds using 1,2-diaminobenzene

Dicarbonyl compound	Derivative	Mass spectrum (principal ions and abundance)
Glyoxal	Quinoxaline	130 (100), 103 (56.2), 76 (46.8), 50 (20.2), 75 (10.4), 131 (9.4)
Methylglyoxal	2-Methylquinoxaline	144 (100), 117 (77.8), 76 (40.5), 77 (23.3), 50 (21.9), 75 (11.3), 145 (10.3)
Diacetyl	2,3-Dimethylquinoxaline	117 (100), 158 (75.6), 76 (32.3), 77 (23.1), 50 (18.3), 75 (10.4)
2,3-Pentanedione	2-Ethyl-3-methylquinoxaline	171 (100), 172 (98), 130 (34.1), 75 (33.3), 77 (21), 50 (19.4), 144 (19), 143 (14.1), 103 (14)
2,3-Hexanedione	2,3-Diethylquinoxaline	158 (100), 171 (20.1), 76 (13.7), 77 (12.8),

**COMPENDIUM OF INTERNATIONAL ANALYSIS OF
METHODS – OIV
 α -dicarbonyl compounds by GC after derivatization**

159 (11.4), 157 (10.8),
50 (8.1)

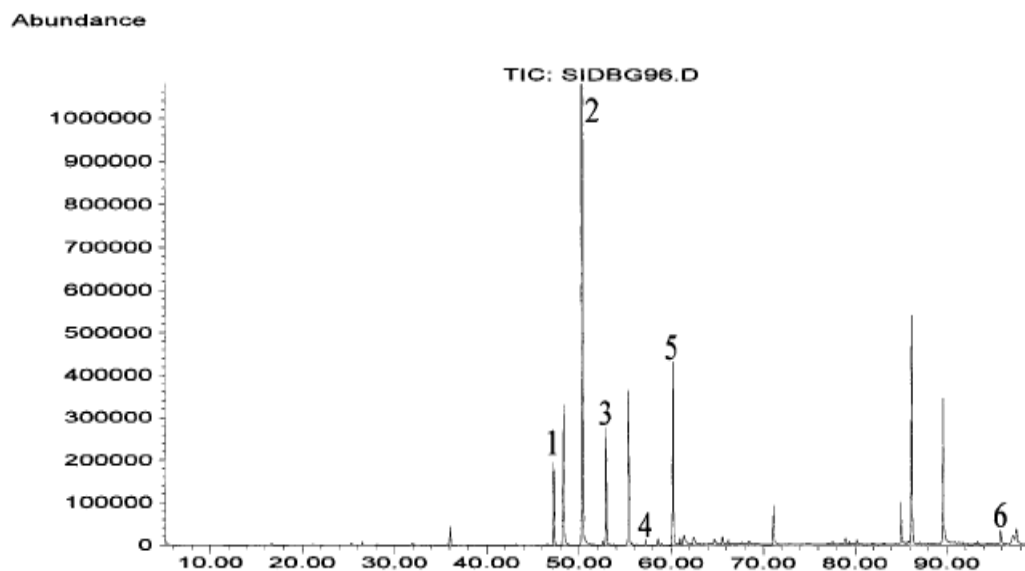

Figure 3. Gas chromatogram of the extract from the dicarbonyl compounds derivatized by 1,2-diaminobenzene from a white wine, detected by mass spectrometry by selecting the ions $m/z = 76, 77, 103, 117, 130, 131, 144, 158, 160$ and 171 . BP21 Column, $50\text{m} \times 0.32\text{mm} \times 0.25 \mu\text{m}$ oven temperature 60°C for 1min, then programmed increase of $2^\circ\text{C}/\text{min}$ up to 220°C . Injector temperature: 250°C .

1. glyoxal; 2. methylglyoxal; 3. diacetyl; 4. 2,3-pentanedione; 5. 2,3-hexanedione (internal standard); 6. phenylglyoxal (not studied with this method).

**COMPENDIUM OF INTERNATIONAL ANALYSIS OF
METHODS – OIV
 α -dicarbonyl compounds by GC after derivatization**

Bibliography

Bartowski E.J. and Henschke P.A. The buttery attribute of wine – diacetyl – desirability spoilage and beyond. *Int. J. Food Microbiol.* 96: 235-252 (2004).

Bednarski W., Jedrychowski L., Hammond E., and Nikolov L., A method for determination of α -dicarbonyl compounds. *J. Dairy Sci.* 72:2474-2477 (1989).

Leppanen O., Ronkainen P., Koivisto T. and Denslow J. A semiautomatic method for the gas chromatographic determination of vicinal diketones in alcoholic beverages. *J. Inst. Brew.* 85:278- 281 (1979).

Martineau B., Acree T. and Henick-Kling T., Effect of wine type on the detection threshold for diacetyl. *Food Res. Int.* 28:139-143 (1995).

Moree-Testa P. and Saint-Jalm Y., Determination of α -dicarbonyl compounds in cigarette smoke. *J. Chromatogr.* 217:197-208 (1981).

De Revel G., Pripis-Nicolau L., Barbe J.-C. and Bertrand A., The detection of α -dicarbonyl compounds in wine by the formation of quinoxaline derivatives. *J. Sci. Food Agric.* 80:102-108 (2000).

De Revel G. and Bertrand A. Dicarbonyl compounds and their reduction products in wine. Identification of wine aldehydes. *Proc 7th Weurman Flavour Research Symp., Zeist, June, pp 353-361 (1994).*

De Revel G. and Bertrand A., A method for the detection of carbonyl compounds in wine: glyoxal and methylglyoxal. *J. Sci. Food Agric.* 61:267-272 (1993).

Voulgaropoulos A., Soilis T. and Andricopoulos N., Fluorimetric determination of diacetyl in wines after condensation with 3,4-diaminoanisole. *Am. J. Enol. Vitic.* 42:73-75 (1991).

Gilles de Revel et Alain Bertrand, Analyse des composés α -dicarbonyles du vin après dérivation par le 1-2-diaminobenzène OIV FV 1275

**Determination of carboxymethyl cellulose (cellulose gum,
CMC) in white wines**
(OIV/OENO 404/2010)

OIV-MA-AS315-22

Type of method: IV

1. Introduction

Carboxymethyl cellulose (CMC) is a polymer derived from natural cellulose that has been routinely used for many years now as a food additive (INS 466) in products such as ice creams and pre-cooked meals [1], to give them smoothness. The use of CMC in white wines and sparkling wines to contribute to their tartaric stabilisation [2] was recently accepted by the OIV in resolution Oeno 2/2008 provided that the dose added to the wine is less than 100 mg/l. A specific method for determination of CMC in white wine has therefore been developed based on the method of H.D Graham published in 1971 [3].

2. Field of application

The method applies to white wines (still and sparkling).

3. Principle

Once the CMC has been isolated from the wine by dialysis, it is hydrolysed in an acid medium to form glycolic acid which is then degraded to form formaldehyde. 2,7-Dihydroxynaphthalene (DHN) is added to form 2,2,7,7-tetrahydroxydinaphthylmethane in the presence of formaldehyde. The complex formed develops a purple-blue colour under the action of concentrated sulphuric acid, at 100 °C, allowing colorimetric measurement at 540nm (Figure 1).

**COMPENDIUM OF INTERNATIONAL ANALYSIS OF METHODS –
OIV
CMC in white wines**

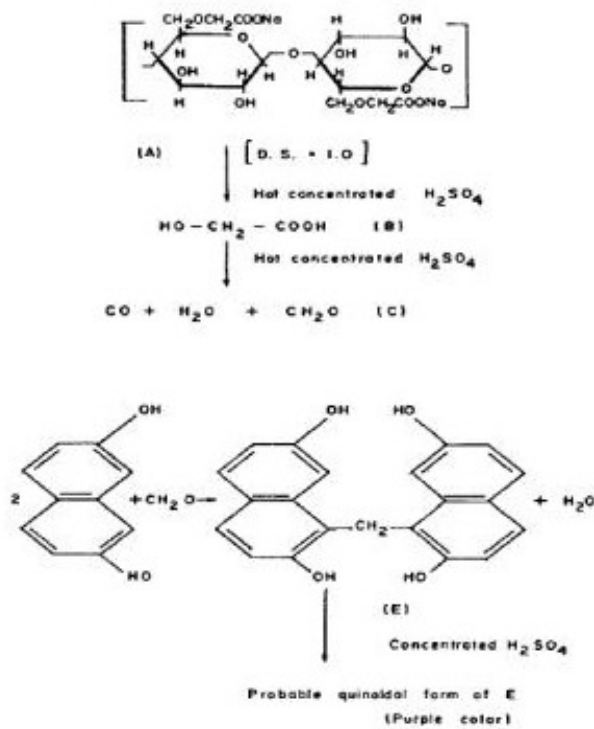

Figure 1: Mechanism of reaction of CMC with DHN in hot concentrated sulphuric acid (Feigl, 1966)

4. Reagents

- Sodium carboxymethylcellulose [N° CAS [9004-32-4](#)] (21902 - average viscosity 400-1000 mPa·s, substitution degree 0.60-0.95)
- 2,7-Dihydroxynaphthalene [N° CAS [582-17-2](#)] (purity > 98,0 % - HPLC)
- 95 % concentrated sulphuric acid
- Purified water for laboratory use (example of quality: EN ISO 3696)

5. Equipment

- Laboratory glassware
- Dialysis membrane (6000 to 8000 Da)
- Temperature-controlled bath
- Double-beam UV-visible spectrophotometer

6. Operating procedure

6.1 Preparation of the reagent

- Place 50 mg of DHN weighed to within 1 mg in a calibrated 100 mL phial.
- Add concentrated sulphuric acid up to the gauge line.
- Place the calibrated phial in a temperature-controlled bath at 28 °C for 4h (without stirring).
- After heating, decant the reagent into a brown flask and store it in a refrigerator at 4 °C.

6.2 Preparation of wine test specimens

- Insert 20 mL of wine, after degassing, into the dialysis membrane.
- Place the dialysis membrane containing the wine in a 6-litre flask filled with distilled water.
- Leave to dialyse for 24h, changing the dialysis water twice.

6.3 Colour reaction

- Place 1 mL of dialysed wine into a test tube.
- Add 9 mL of reagent.
- Place the test tube in a temperature-controlled bath at 100 °C for 2h.
- Analyse the coloured solution by UV-visible spectrophotometer at 540nm and read the absorbance value.

6.4 Calculation of the wine's CMC content

- Recording the absorbance value read in point 6.3 on the calibration curve obtained for a wine (see figure 2)

7. Characteristics of the method

Certain elements of the internal validation were determined but these do not constitute a formal validation according to the protocol governing the planning, the implementing and the interpretation of performance studies pertaining to analysis methods (OIV 6/2000)

7.1 Linearity of the response

A white wine has been added with incremental quantities of CMC ranging between 0 and 100 mg/L, then submitted to dialysis and treated in the conditions defined in the procedure described above. The response is linear for the concentrations under consideration (figure 2).

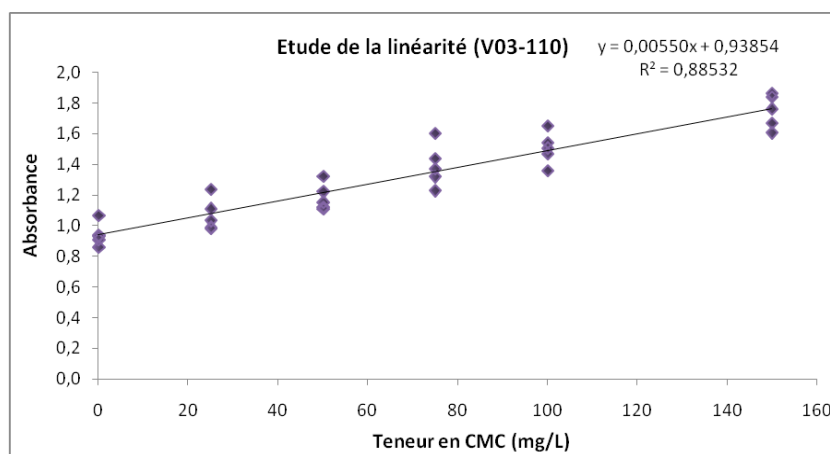

Figure 2: Linearity of CMC determination in white wine

7.2 Repeatability

The repeatability of the determination of CMC in white wines was defined on the basis of the results achieved on 22 samples of wine that underwent 2 successive analyses, so as to be analysed in identical conditions. The results are given in table 1.

**COMPENDIUM OF INTERNATIONAL ANALYSIS OF METHODS –
OIV
CMC in white wines**

	calculated values
Repeatability:	
standard deviation	0,075
CV in %	7,2 %
r-limit	0,21
r-limit in %	20 %

Table 1: Repeatability of CMC determination in white wine

7.3 Reproducibility

The reproducibility of the determination of CMC in white wines was defined through the analysis of a white wine by CMC, on 12 occasions at different dates. The results are given in table 2.

	calculated values
reproducibility	
standard deviation	0,082
CV in %	9,6 %
R-limit	0,23
R-limit in %	27 %

Table 2: Reproducibility of CMC determination in white wine

7.4 Specificity

The specificity of CMC determination was verified by adding known quantities of CMC into white wines. The recovery rates thus measure are given in table 3.

**COMPENDIUM OF INTERNATIONAL ANALYSIS OF METHODS –
OIV
CMC in white wines**

Sample	Added concentration (mg/l)	Resulting concentration (mg/l)	Recovery rate
Wine 1	50	33	66 %
Wine 1	50	51	102 %
Wine 1	50	24	77 %
Wine 2	75	78	104 %
Wine 2	75	90	121 %
Wine 2	75	69	92 %
Wine 3	100	109	109 %
Wine 3	100	97	97 %
Wine 3	100	103	103 %
Wine 4	150	163	109 %
Wine 4	150	149	100 %
Wine 4	150	159	106 %

Table 3: Specificity of CMC determination in white wine

7.4 Detection and quantification limits

The detection limits (LD) and quantification limits (LQ) were calculated for an untreated wine that underwent 10 analyses. The detection limit thus determined is of 14 mg/l and the quantification limit is of 61 mg/l.

The method therefore enables to detect the adding of CMC into white wine in quantities exceeding 20 mg/l and to quantify the addition when it exceeds 60 mg/l; this is not highly satisfactory but remains compatible with the maximum authorised dose of 100 mg/l.

7.5 Uncertainty

The uncertainty was calculated at 3 different concentration levels (25, 75 and 150 mg/l) based on the analysis results for wines that have undergone CMC treatment,

using the standard deviation reproducibility. The uncertainty thus obtained is of 40 mg/l, regardless of the CMC determination.

8. Bibliography

- [1] Regulation (CE) N° 1333/2008 of the 16th of December, 2008 concerning food additives
- [2] Stabilisation tartrique des vins par la carboxyméthylcellulose - Bulletin de l'OIV 2001, vol 74, n°841-842, p151-159.
- [3] Determination of carboxymethylcellulose in food products - H.D Graham, Journal of food science 1971, p 1052-1055

**COMPENDIUM OF INTERNATIONAL ANALYSIS OF METHODS –
OIV**
**Criteria for the quantification of potentially allergenic residues of
fining agent proteins in wine**

OIV-MA-AS315-23

Type of Method: IV

**CRITERIA FOR THE METHODS OF QUANTIFICATION
OF POTENTIALLY ALLERGENIC RESIDUES OF
FINING AGENT PROTEINS IN WINE**

OIV/OENO 427/2010
OIV-COMEX 502-2012

1 Method Criteria Definitions

Trueness the closeness of agreement between the average value obtained from a large series of test results and an accepted reference value

$r =$ Repeatability limit, the value below which the absolute difference between 2 single test results obtained under repeatability conditions (i.e., same sample, same operator, same apparatus, same laboratory, and short interval of time) may be expected to lie within a specific probability (typically 95%) and hence $r = 2.8 \times S_r$.

$S_r =$ Standard deviation, calculated from results generated under repeatability conditions.

$RSD_r =$ Relative standard deviation, calculated from results generated under repeatability conditions $[(S_r/\bar{x}) \times 100]$, where \bar{x} is the average of results over all laboratories and samples.

**COMPENDIUM OF INTERNATIONAL ANALYSIS OF METHODS –
OIV**

**Criteria for the quantification of potentially allergenic residues of
fining agent proteins in wine**

R =	Reproducibility limit, the value below which the absolute difference between single test results obtained under reproducibility conditions (i.e., on identical material obtained by operators in different laboratories, using the standardised test method), may be expected to lie within a certain probability (typically 95%); $R = 2.8 \times S_R$.
S_R =	Standard deviation, calculated from results under reproducibility conditions.
RSD_R =	Relative standard deviation calculated from results generated under reproducibility conditions $[(S_R/\bar{x} \times 100]$
Ho_R =	HORRAT value: the observed RSD_R value divided by the RSD_R value calculated from the Horwitz equation.
B_0 =	Mean blank
LOD =	Limit of detection, calculated as $LOD = B_0 + 3 \times S_t(B_0)$
LOQ =	Limit of quantification, calculated as $LOQ = B_0 + 10 \times S_t(B_0)$

2. General Aspects

Requirement

The method of analysis must be associated with specific oenological practices

Additives or processing aids containing allergenic proteins

Each product must be characterized from the chemical point of view and quality control is strictly necessary

Class of analytical methods

**COMPENDIUM OF INTERNATIONAL ANALYSIS OF METHODS –
OIV**

**Criteria for the quantification of potentially allergenic residues of
fining agent proteins in wine**

Generally speaking, immunoenzymatic approaches are considered the most suitable and easy methods for routine control of allergens.

The determination of allergenic fining agent proteins residues in wines could use Sandwich, Competitive, Direct or Indirect ELISA methods. If no enzyme-labeled antibody is available a biotinylated antibody and avidine-HRP conjugate can be used for detection.

Antibody

- Antibody characterization (evaluation of detection of allergens with higher or lower affinity)
- High specificity for the commercial processing aids (characterized as described above)
- Cross-reactivity characterization taking in account the proteins usually included in enological practices
- Capability to detect allergen derivatives that could be formed by enological treatments (proteolysis or modified molecules)

Method

- Antibody must have optimal binding properties in wine samples
- Methods must have optimal performances in wine samples having different chemical characteristics (pH and dry extract, red and white wine, etc..)
- Results in wines coming from different geographical area (even when different enological practices are applied) must be comparable
- The binding properties of the antibodies must be optimal with different condition of maturation of wine (time, temperatures, color changes ...)

3. Type of methods

Specific methods for the determination of fining agent proteins in wine are not prescribed yet. Several ELISA methods are already available and can be applied.

**COMPENDIUM OF INTERNATIONAL ANALYSIS OF METHODS –
OIV**

**Criteria for the quantification of potentially allergenic residues of
fining agent proteins in wine**

Laboratories shall use a method validated to OIV requirements that fulfils the performance criteria indicated in Table 1. Wherever possible, the validation shall include a certified reference material in the collaborative trial test materials. If not available, an alternative estimation of trueness should be used.

The General Protocol for the Direct and Indirect ELISA Method

The direct, one-step method uses only one labeled antibody. This labeled antibody is incubated with the antigen contained in the sample/standard and bound to the well.

The indirect, two-step method uses a labeled secondary antibody for detection. First, a primary antibody is incubated with the antigen contained in the sample/standard and bound to the well. This is followed by incubation with a labeled secondary antibody that recognizes the primary antibody.

Direct

1. Prepare a surface to which antigen in sample is bound.
2. Block any non-specific binding sites on the surface.
3. Apply enzyme-linked antibodies that bind specifically to the antigen.
4. Wash the plate, so that the antibody-enzyme conjugates in excess (unbound) are removed.
5. Apply a chemical which is converted by the enzyme into a color or fluorescent or electrochemical signal.
6. Measure the absorbance or fluorescence or electrochemical signal (e.g., current) of the plate wells to determine the presence and quantity of antigen.

Before the assay, the antibody preparations must be purified and conjugated.

Indirect

1. Prepare a surface to which antigen in sample is bound.
2. Block any non-specific binding sites on the surface.
3. Apply primary antibodies that bind specifically to the antigen

**COMPENDIUM OF INTERNATIONAL ANALYSIS OF METHODS –
OIV**

**Criteria for the quantification of potentially allergenic residues of
fining agent proteins in wine**

4. Wash the plate, so that primary antibodies in excess (unbound) are removed.
5. Apply enzyme-linked secondary antibodies which are specific to the primary antibodies.
6. Wash the plate, so that the antibody-enzyme conjugates in excess (unbound) are removed.
7. Apply a chemical which is converted by the enzyme into a color or fluorescent or electrochemical signal.
8. Measure the absorbance or fluorescence or electrochemical signal (e.g., current) of the plate wells to determine the presence and quantity of antigen.

Before the assay, both antibody preparations must be purified and one must be conjugated.

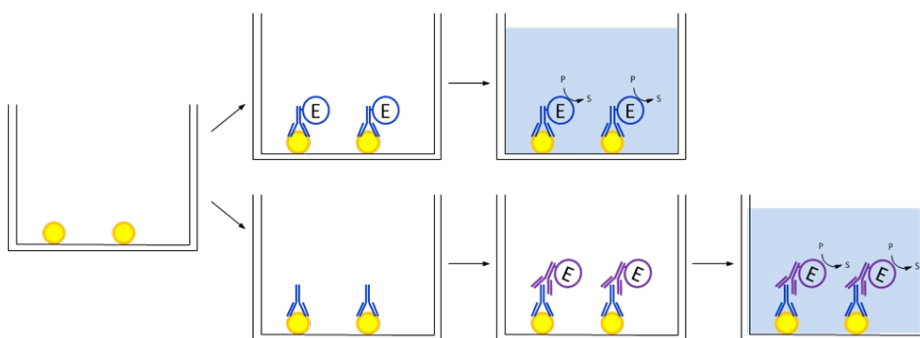

Figure 1: Direct and indirect ELISA

For most applications, a high-binding polystyrene microtiter plate is best; however, consult manufacturer guidelines to determine the most appropriate type of plate for binding the given antigen.

The major advantage of direct and indirect ELISA is the high sensitivity, achieved via a comparably easy set-up with reduced chances of unspecific binding. However, it is only applicable in samples containing low amounts of non-antigen protein.

**COMPENDIUM OF INTERNATIONAL ANALYSIS OF METHODS –
OIV**

**Criteria for the quantification of potentially allergenic residues of
fining agent proteins in wine**

General Protocol for the competitive ELISA Method

The term "competitive" describes assays in which measurement involves the quantification of a substance by its ability to interfere with an established system. The detection can be done directly, one-step method, or indirectly, two-step method.

Direct

1. Prepare a surface to which a known quantity of wanted antigen is bound.
2. Block any non-specific binding sites on the surface.
3. Apply the sample or standard (antigen) and the enzyme-linked antibodies that bind specifically to the antigen on the coated microplate. The antigens immobilized on the surface and the antigens in solution “compete” for the antibodies. Hence, the more antigen in the sample, the less antibody will be bound to the immobilized antigens.
4. Wash the plate so that the antibodies in excess (unbound) and unbound antigen-antibody-complexes are removed.
5. Apply a chemical which is converted by the enzyme into a color or fluorescent or electrochemical signal.
6. Measure the absorbance or fluorescence or electrochemical signal (e.g., current) of the plate wells to determine the presence and quantity of antigen.

Before the assay, the antibody preparations must be purified and must be conjugated.

Indirect

1. Prepare a surface to which a known quantity of antigen is bound.
2. Block any non-specific binding sites on the surface.
3. Apply the sample or standard (antigen) and the specific primary antibody to the coated microplate. The antigens immobilized on the surface and the antigens in solution “compete” for the antibodies.

**COMPENDIUM OF INTERNATIONAL ANALYSIS OF METHODS –
OIV**

**Criteria for the quantification of potentially allergenic residues of
fining agent proteins in wine**

Hence, the more antigen in the sample, the less antibody will be bound to the immobilized antigens.

4. Wash the plate so that the antibodies in excess (unbound) and unbound antigen-antibody-complexes are removed.
5. Add a secondary antibody, specific to the primary antibody, conjugated with an enzyme.
6. Wash the plate so that the conjugated antibodies in excess (unbound) are removed
7. Apply a chemical which is converted by the enzyme into a color or fluorescent or electrochemical signal.
8. Measure the absorbance or fluorescence or electrochemical signal (e.g., current) of the plate wells to determine the presence and quantity of antigen.

Before the assay, both antibody preparations must be purified and one must be conjugated.

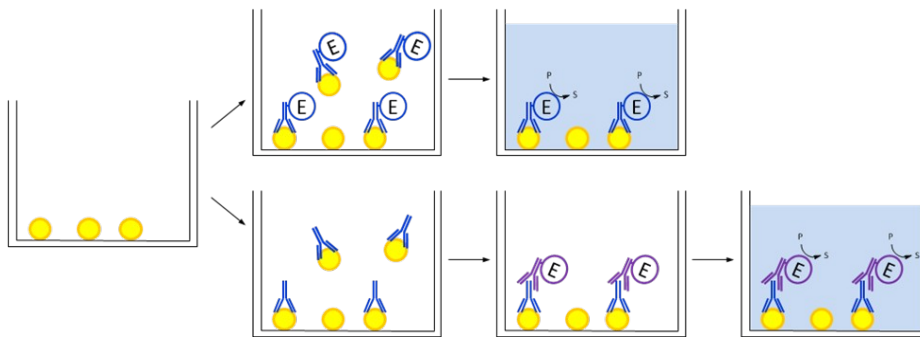

Figure 2: Direct and indirect competitive ELISA

For competitive ELISA, the higher the original antigen concentration, the weaker is the signal.

For most applications, a high-binding polystyrene microtiter plate is best; however, consult manufacturer guidelines to determine the most appropriate type of plate for binding the given antigen.

**COMPENDIUM OF INTERNATIONAL ANALYSIS OF METHODS –
OIV**

**Criteria for the quantification of potentially allergenic residues of
fining agent proteins in wine**

General Protocol for the Sandwich ELISA Method

The Sandwich ELISA measures the amount of antigen between two layers of antibodies (i.e. capture and detection antibody). The antigen to be measured must contain at least two different antigenic sites (epitopes) for binding two different antibodies. Either monoclonal or polyclonal antibodies can be used.

Direct

1. Prepare a surface to which capture antibody is bound.
2. Block any non-specific binding sites on the surface.
3. Apply the antigen-containing sample or standard to the plate.
4. Wash the plate, so that unbound antigen is removed.
5. Apply enzyme-linked antibodies (detection antibodies) that bind specifically to the antigen.
6. Wash the plate, so that the enzyme-linked antibodies in excess (unbound) are removed.
7. Apply a chemical which is converted by the enzyme into a color or fluorescent or electrochemical signal.
8. Measure the absorbance or fluorescence or electrochemical signal (e.g., current) of the plate wells to determine the presence and quantity of antigen.

Before the assay, both antibody preparations must be purified and one must be conjugated.

Indirect

1. Prepare a surface to which capture antibody is bound.
2. Block any non specific binding sites on the surface.
3. Apply the antigen-containing sample or standard to the plate.
4. Wash the plate, so that unbound antigen is removed.
5. Apply primary antibodies that bind specifically to the antigen.
6. Wash the plate, so that primary antibody in excess (unbound) is removed.
7. Apply enzyme-linked antibodies (secondary antibodies) that bind specifically to the primary antibody.

**COMPENDIUM OF INTERNATIONAL ANALYSIS OF METHODS –
OIV**

**Criteria for the quantification of potentially allergenic residues of
fining agent proteins in wine**

8. Wash the plate, so that the enzyme-linked antibodies in excess (unbound) are removed.
9. Apply a chemical which is converted by the enzyme into a color or fluorescent or electrochemical signal.
10. Measure the absorbance or fluorescence or electrochemical signal (e.g., current) of the plate wells to determine the presence and quantity of antigen.

Before the assay, all the antibody preparations must be purified and one of them must be conjugated.

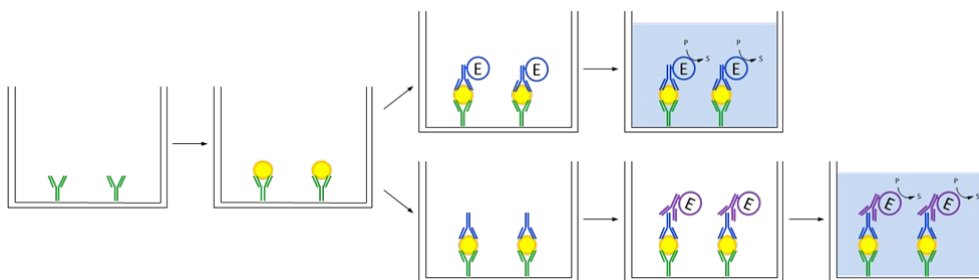

Figure 3: Direct and indirect Sandwich-ELISA

For indirect Sandwich-ELISA, it is necessary for the capture antibodies and the detection antibodies to be raised in different species (e.g. mouse and rabbit), so that the enzyme-linked secondary antibodies specific for the detection antibodies do not bind to the capture antibodies, as well.

For most applications, a high-binding polystyrene microtiter plate is best; however, consult manufacturer guidelines to determine the most appropriate type of plate for binding the given antigen.

For sandwich ELISA, the measure is proportional to the amount of antigen in samples.

The advantage of Sandwich ELISA is that even crude samples do not have to be purified before analysis, and the assay can be very sensitive.

**COMPENDIUM OF INTERNATIONAL ANALYSIS OF METHODS –
OIV**

**Criteria for the quantification of potentially allergenic residues of
fining agent proteins in wine**

Table 1: Performance criteria for methods of analyses for potentially allergenic fining agent proteins in wine

Parameter	Value/Comment
Applicability	Suitable for determining fining agents in wine for official purposes.
Detection limit	(expressed in mg/L) ≤ 0,25
Limit of quantification	(expressed in mg/L) ≤ 0,5
Precision	HORRAT values of less or equal to 2 in the validation collaborative trial
Recovery	80% - 105% (as indicated in the collaborative trial)
Specificity	Free from matrix interferences
Trueness	$ \bar{x} - m < 1,96 * \sqrt{S_R(lab)^2 - S_r(lab)^2 * (1 - 1/n)}$ <p>where m is the certified value of the wine reference material and \bar{x} is the average of n measurements of compound content in this wine, within the same laboratory.</p> <p>$S_r(lab)$ are standard deviations, calculated from results within the same laboratory under repeatability conditions.</p> <p>$S_R(lab)$ are standard deviations, calculated from results within different laboratories under reproducibility conditions.</p>

**COMPENDIUM OF INTERNATIONAL ANALYSIS OF METHODS –
OIV
Criteria for the quantification of potentially allergenic residues of
fining agent proteins in wine**

Method OIV-MA-AS315-24

Type IV method

**Determination of lysozyme in wine using high-
performance capillary electrophoresis**

OIV-OENO 385-2012

1. Introduction

This method is used to detect the addition of lysozyme in wine but is not suitable for the assay or determination of lysozyme as an allergenic compound.

Determination of residual lysozyme in treated wines is performed using high-performance capillary electrophoresis (HPCE).

2. Scope

This method applies to lysozyme determination in white wines at concentrations ranging from 9 mg/L to 100 mg / L, and by dilution above this level.

3. Principle

The wine samples are directly injected into the capillary-electrophoresis instrument after filtration and dilution, as needed. The quantification of lysozyme is performed against an external standard.

4. Reagents

Lysozyme extract of chicken egg white [CAS No. 12650-88-3]

85% Phosphoric acid [CAS No. 7664-38-2]

Hydroxypropyl methylcellulose (HPMC) [CAS No 9004-65-3]

Purified water for laboratory use, for example to EN ISO 3696 grade (water for analytical laboratory use - specification and test methods [ISO 3696:1987]).

5. Apparatus

Standard laboratory apparatus

Capillary electrophoresis instrument with a UV spectrophotometric detector

6. Sample preparation

The wine to be analysed is diluted four-fold in distilled water for analysis by capillary electrophoresis, in order to fit within the linear dynamic range of the method (lysozyme content lower than 100 mg/l).

7. Analytical conditions

Capillary: fused silica (37 cm length, 75 µm diameter)

Buffer: phosphoric acid (75 mm) HPMC (0.1 %), pH 1.68

Injection time: 15 sec

Injection mode: hydrostatic procedure (3447.38 Pa)

Temperature: 25°C

Applied voltage: 7 kV

Detection: UV 214 nm

8. Calculation

A calibration curve is produced based on lysozyme solutions in water at 10, 20, 50, and 100 mg/l. Depending on the external calibration method, lysozyme quantification is performed by measuring the lysozyme peak area in the wine and comparing it with the corresponding concentration on the calibration curve.

9. Method characteristics

9.1 Linearity of response

As the maximum authorized dose of lysozyme which may be added to wines is 500 mg/l, a standard range containing 5 to 500 mg/l of lysozyme in aqueous solution was prepared. Each solution was analysed five times.

Above 100 mg/l, the response is no longer linear. The linear dynamic range of the method is from 5 to 100 mg/l, as shown on the calibration curve in Figure 1.

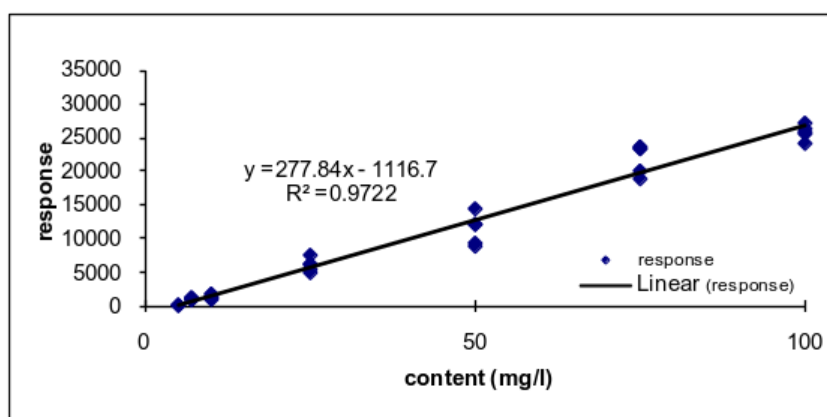

Figure 1: Linearity of lysozyme determination using HPCE

9.2 Repeatability

The repeatability of lysozyme determination in white wines has been determined from the results obtained across 20 wines with added lysozyme, analysed twice in succession, in order to be tested under identical conditions. The results are given in table 1:

Table 1: Repeatability of lysozyme determination using HPCE

Repeatability	Calculated values
standard deviation in mg/L	2.63
CV %	1.4%
r limit in mg/L	7.35
r limit %	4%

9.3 Reproducibility

The reproducibility of lysozyme determination in white wines has been determined by analysing the same white wine, with 200 mg/L of lysozyme added, 8 times on different dates. The results are given in Table 2.

Table 2 - Reproducibility of lysozyme determination using HPCE

Reproducibility	Calculated value
standard deviation in mg/L	11.75
CV %	5.8%
R limit in mg/L	32.90
R limit %	16%

9.4 Limits of detection and quantification

Limits of detection (LoD) and quantification (LoQ) are determined based on the background noise measured near the lysozyme peak corresponding to the first calibration point, i.e. 5 mg/L. The results obtained are as follows:

$$\text{LoD} = 3 \times \text{background noise (mg/L)} = 3 \text{ mg/L}$$

$$\text{LoQ} = 10 \times \text{background noise (mg/L)} = 9 \text{ mg/L}$$

9.5 Uncertainty

Uncertainty was determined using the intralaboratory reproducibility standard deviation, this is 12 %.

10. Bibliography

S. Chauvet, C. Lagrèze, A. Domec, M-H Salagoïty, B. Médina: Dosage du lysozyme dans le vin par électrophorèse capillaire haute performance OIV FV 1274

ME. Barbeito, C. Coria, C. Chiconofri : Influencia del filtrado de vinos para la determinación de lisozima según oeno 8/2007 OIV FV1306

Method OIV-MA-AS315-25

Type IV method

**Determination of lysozyme in wine using high-
performance liquid chromatography**
(OIV-OENO 458-2014)

1. Introduction

This method describes the analytical procedure used to determine lysozyme in red and white wines. The determination can be carried out on the sample directly for white wines, but for red wines a dissociation of the enzyme from the polyphenolic macromolecules by means of rapid alkalisation must be undertaken, using the principle of the amphoteric nature of the protein.

2. Field of application

This method allows the lysozyme (mg of protein·L⁻¹) content in red and white wines to be quantified independently from enzyme activity. It should be made clear that this method makes it possible to detect lysozyme added to wine, but the limit of detection of the method does not exclude any allergenicity associated with the presence of low levels of lysozyme.

3. Principle

The analysis is carried out using high performance liquid chromatography (HPLC) with a spectrofluorimetric detector. The unknown quantity in the wine sample is calculated according to the chromatographic peak area using the external standard method.

4. Materials and reagents

4.1. Solvents and working solutions

- 4.1.1. Acetonitrile (CH₃CN), HPLC grade (CAS no. 75-05-8)
- 4.1.2. Trifluoroacetic acid (TFA) (CAS no. 76-05-1)
- 4.1.3. Deionised water, HPLC grade (CAS no. 7732-18-5)
- 4.1.4. Lysozyme standard (CAS no. 9001-63-2)
- 4.1.5. Tartaric acid (CAS no. 87-69-4)
- 4.1.6. Ethanol (CAS no. 64-17-5)

**COMPENDIUM OF INTERNATIONAL ANALYSIS OF METHODS -
OIV**

**Determination of lysozyme in wine using high-performance
liquid chromatography**

- 4.1.7. Neutral potassium tartrate (CAS no. 921-53-9)
- 4.1.8. 28% Ammonium hydroxide (w/w) (CAS no. 1336-21-6)
- 4.1.9. 0.65 μm cellulose acetate filters

4.2 Stock solution: 1 $\text{g}\cdot\text{L}^{-1}$ of tartaric acid in 10% ethanol (v/v) adjusted to a pH of 3.2 with neutral potassium tartrate.

4.3 Eluents

- A: 1% CH_3CN , 0.2% TFA, 98.8% H_2O
- B: 70% CH_3CN , 0.2% TFA, 29.8% H_2O

4.4 Reference solution

Solution containing 250 $\text{mg}\cdot\text{L}^{-1}$ lysozyme standard dissolved in the stock solution by stirring continuously for 1 hour. It is stored in a refrigerator for a maximum of 4 weeks.

4.5 Preparation of working solutions

For the working solutions, the reference solution is diluted with the stock solution until the desired concentrations have been reached. These solutions are prepared daily.

5. Equipment

5.1 HPLC apparatus equipped with a pumping system suitable for gradient elution

5.2 Thermostatted column compartment (oven)

5.3 Spectrofluorimetric detector

5.4 20 μL loop injection

5.5 Reverse phase polymeric column with phenyl functional groups (porosity = 1,000 \AA , exclusion limit = 1,000,000 Da), Tosoh Bioscience TSK-gel Phenyl 5PW RP, 4.6 mm ID x 7.5 cm, for example.

5.6 Pre-column in the same material as the column: Tosoh Bioscience TSK-gel Phenyl 5PW RP Guardgel, 3.2 mm ID x 1.5 cm, for example.

6. Operating conditions (by way of example)

6.1 Eluent flow rate: 1 $\text{mL}\cdot\text{min}^{-1}$

6.2 Elution temperature: 40°C

6.3 Spectrofluorimetric detector: $\lambda_{\text{ex}} = 276 \text{ nm}$; $\lambda_{\text{em}} = 345 \text{ nm}$; Gain = 4

6.4 Average lysozyme retention time: 7.9 minutes

**COMPENDIUM OF INTERNATIONAL ANALYSIS OF METHODS -
OIV**

**Determination of lysozyme in wine using high-performance
liquid chromatography**

Time (min)	Mobile phase A (%)	Mobile phase B (%)
0	60	40
10.00	0	100
10.20	60	40
12.00	Controller	Stop

7. Sample preparation

7.1 White wines

White wine samples are filtered using cellulose acetate filters with 0.65 µm porosity and then undergo chromatographic analysis. (There is a lower recovery rate if using nylon filters with 0.45 µm porosity.)

7.2 Red wines

Red wine samples (50 mL) are adjusted to a pH of 11.5. The samples are alkalised using NH₄OH (taking into account the volume of the latter for the final calculation) and are then immediately filtered (after 5 min) using cellulose acetate filters with 0.65 µm porosity and injected into the liquid chromatograph. (There is a lower recovery rate if using nylon filters with 0.45 µm porosity.)

8. Control sample preparation

The reference standard solution (4.4) is added to the sample and it is prepared as described in point 7. The percentage recovery is determined.

9. Expression of results

Adequate resolution was observed for the chromatographic profile of lysozyme standard for the analyte tested, with the below chromatographic conditions (Fig. 1 and Fig.4). Analysis of the lysozyme-free sample enabled the wine profile to be observed without finding any interferences in the enzyme detection (Fig. 2 and Fig. 5).

In white wines, more than 95% of the enzyme was recovered (Fig. 3), while in red wines an enzyme recovery of between 70 and 95% was observed using this method, depending on the polyphenol concentration present in the wine sample (Fig. 6). The result is expressed in milligrams per litre (mg·L⁻¹).

Determination of lysozyme in wine using high-performance
liquid chromatography

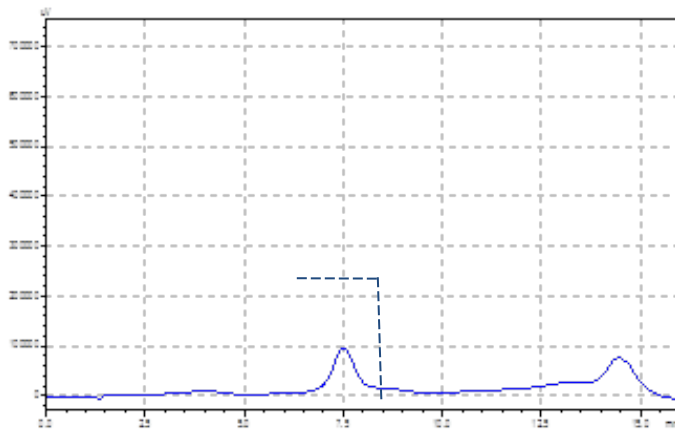

Fig. 1 Chromatogram of the 10 mg·L⁻¹ lysozyme standard

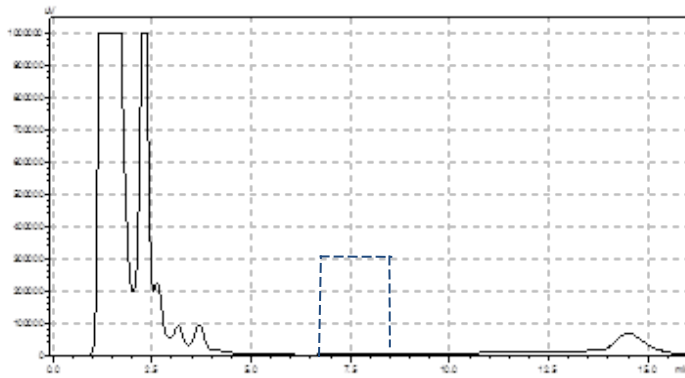

Fig. 2 Chromatogram of a white wine sample without lysozyme

Determination of lysozyme in wine using high-performance
liquid chromatography

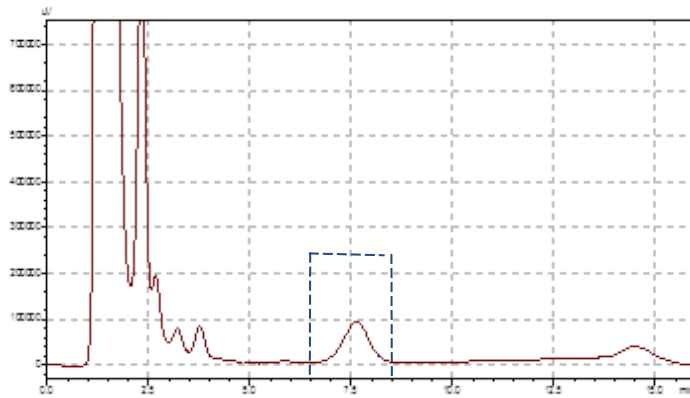

Fig. 3 Chromatogram of a white wine sample with 10 mg·L⁻¹ lysozyme

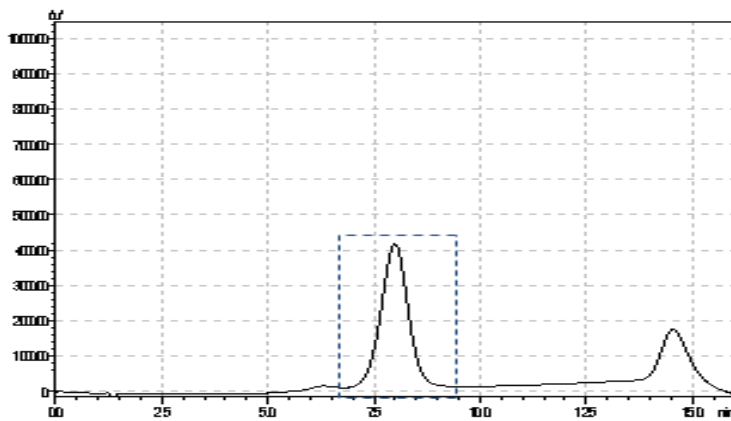

Fig. 4 Chromatogram of the 50 mg·L⁻¹ lysozyme standard

Determination of lysozyme in wine using high-performance
liquid chromatography

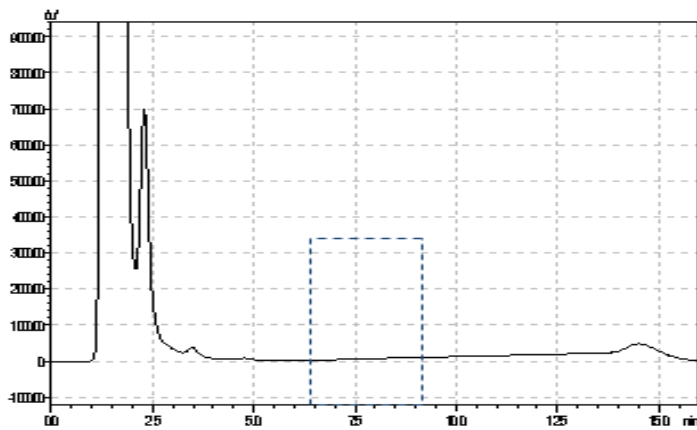

Fig. 5 Chromatogram of a red wine sample without lysozyme

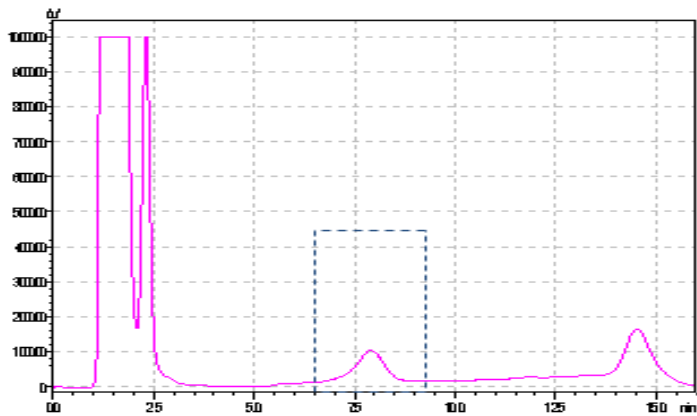

Fig. 6 Chromatogram of a red wine sample with 50 mg·L⁻¹ lysozyme.

**COMPENDIUM OF INTERNATIONAL ANALYSIS OF METHODS -
OIV**

**Determination of lysozyme in wine using high-performance
liquid chromatography**

10. Analytical procedure for white wines

10.1. Internal validation parameters

10.1.1. Repeatability

The repeatability of the method was studied for the interval between 2 mg·L⁻¹ and 25 mg·L⁻¹ in white wine. 17 samples of white wine enriched with various lysozyme concentrations were analysed in duplicate.

The repeatability results obtained at a probability level of 95% were as follows:

Concentration measured in mg·L⁻¹	Sr mg·L⁻¹	r (2.8xSr) mg·L⁻¹
2	0.25	0.7
5	0.30	0.82
10	0.42	1.1
15	0.61	1.7
25	0.40	1.12

The average repeatability limit (r) is 1.2 mg·L⁻¹

10.1.2. Linearity

For the calculation of linearity, 30 peak area measurements of 6 different concentrations of lysozyme in white wine were conducted, these being: an analytical blank without lysozyme, and concentrations of 2 mg·L⁻¹, 5 mg·L⁻¹, 10 mg·L⁻¹, 15 mg·L⁻¹, and 25 mg·L⁻¹. From these measurements, the y-intercept, the gradient and the coefficient of correlation were calculated.

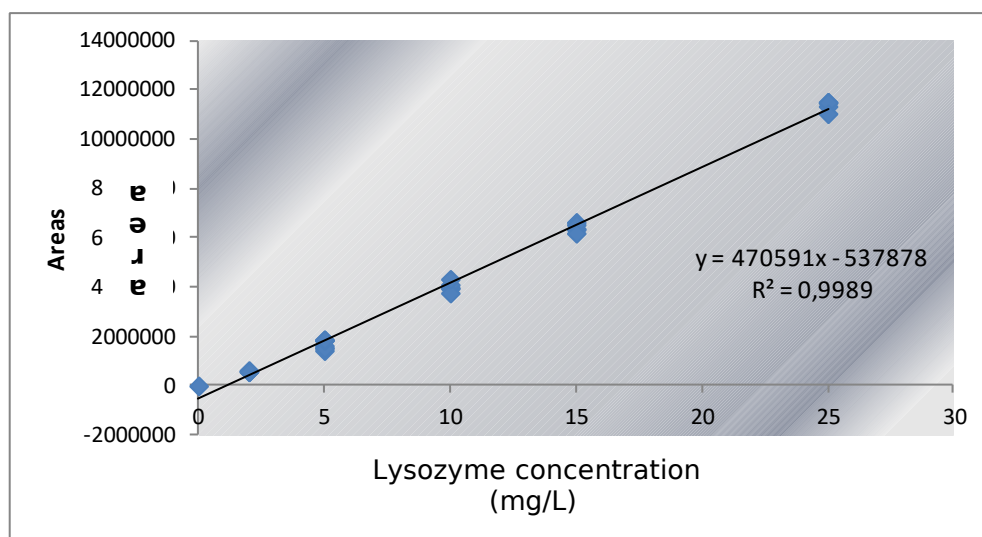

Fig. 7 Dynamic range of lysozyme in white wines up to $25 \text{ mg}\cdot\text{L}^{-1}$

10.1.3. Limit of detection and limit of quantification

The limit of detection obtained for this method was calculated using the graphic procedure derived from the background noise of the recording.

The values obtained were as follows:

LOD: $0.49 \text{ mg}\cdot\text{L}^{-1}$

LOQ: $1.62 \text{ mg}\cdot\text{L}^{-1}$

10.1.4. Intralaboratory reproducibility

The method intralaboratory reproducibility was studied for the interval between $2 \text{ mg}\cdot\text{L}^{-1}$ and $25 \text{ mg}\cdot\text{L}^{-1}$ in a white wine sample for a 30-day period. It should be pointed out that, due to the instability of the analyte, the wine sample was spiked with the lysozyme reference solution (4.4) on the same day as its analysis. 16 measurements were conducted at regular intervals.

The results obtained were as follows:

**COMPENDIUM OF INTERNATIONAL ANALYSIS OF METHODS -
OIV**

**Determination of lysozyme in wine using high-performance
liquid chromatography**

Concentration measured in $\text{mg}\cdot\text{L}^{-1}$	SR $\text{mg}\cdot\text{L}^{-1}$	R (2.8xSR) $\text{mg}\cdot\text{L}^{-1}$
2	0.19	0.53
5	0.36	1.0
10	0.48	1.3
15	0.64	1.8
25	0.93	2.6

The average reproducibility limit (R) is $1.45 \text{ mg}\cdot\text{L}^{-1}$

11. Analytical procedure for red wines

11.1 Internal validation parameters

11.1.1. Repeatability

The repeatability of the method was studied for the interval between $5 \text{ mg}\cdot\text{L}^{-1}$ and $25 \text{ mg}\cdot\text{L}^{-1}$ in red wine. 21 samples of red wine enriched with various lysozyme concentrations were analysed in duplicate.

The repeatability results obtained at a probability level of 95% were as follows:

Concentration measured in $\text{mg}\cdot\text{L}^{-1}$	Sr $\text{mg}\cdot\text{L}^{-1}$	r (2.8xSr) $\text{mg}\cdot\text{L}^{-1}$
5	0.38	1.06
10	0.64	1.79
15	0.59	1.65
25	0.30	0.8

The average repeatability limit (r) is $1.4 \text{ mg}\cdot\text{L}^{-1}$

COMPENDIUM OF INTERNATIONAL ANALYSIS OF METHODS - OIV

Determination of lysozyme in wine using high-performance liquid chromatography

11.1.2. Linearity

For the calculation of linearity, 25 peak area measurements of 5 different concentrations of lysozyme in red wine were conducted, these being: an analytical blank without lysozyme, and concentrations of 5 mg·L⁻¹, 10 mg·L⁻¹, 15 mg·L⁻¹, and 25 mg·L⁻¹. From these measurements, the y-intercept, the gradient and the coefficient of correlation were calculated.

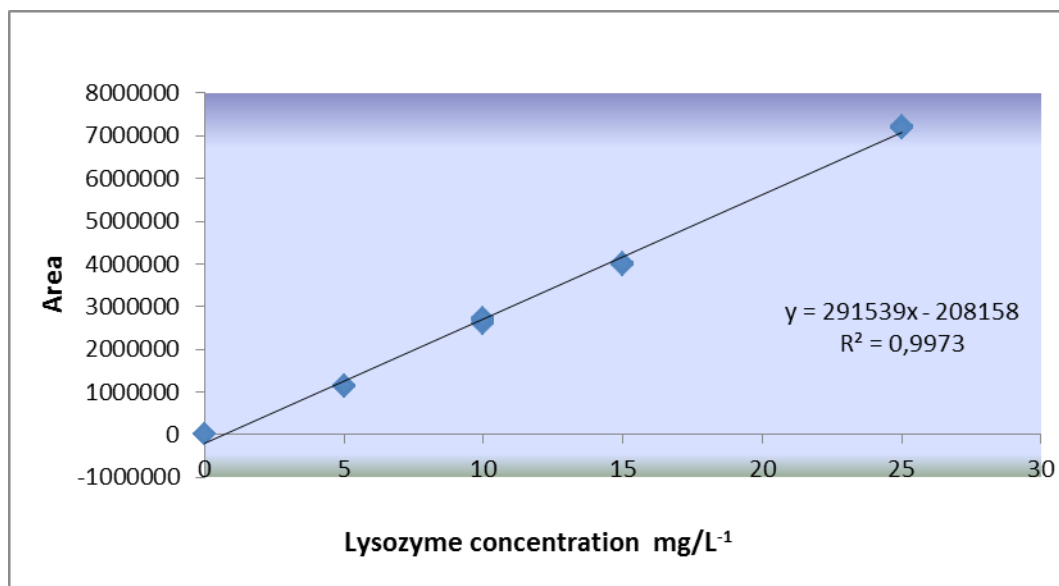

Fig. 8 Dynamic range of lysozyme in red wines up to 25 mg·L⁻¹

11.1.3. Limit of detection and limit of quantification

The limit of detection was calculated using the graphic procedure derived from the background noise of the recording.

The values obtained were as follows:

LOD: 0.88 mg·L⁻¹

LOQ: 2.90 mg·L⁻¹

**COMPENDIUM OF INTERNATIONAL ANALYSIS OF METHODS -
OIV**

**Determination of lysozyme in wine using high-performance
liquid chromatography**

11.1.4. Intralaboratory reproducibility

The method intralaboratory reproducibility was studied for the interval between 5 mg·L⁻¹ and 25 mg·L⁻¹ in a red wine sample for a 30-day period. It should be pointed out that, due to the instability of the analyte, the wine sample was spiked with the lysozyme reference solution (4.4) on the same day as its analysis. 16 measurements were conducted at regular intervals.

The results obtained were as follows:

Concentration measured in mg·L⁻¹	SR mg·L⁻¹	R (2.8xSR) mg·L⁻¹
5	0.4	1.12
10	0.91	2.54
15	0.54	1.5
25	0.53	1.5

The average reproducibility limit (R) is 1.7 mg·L⁻¹

12. Bibliography

1. Resolution OENO 8-2007 "Measurement of lysozyme in wine by high performance liquid chromatography" (2007).
2. Resolution OENO 10-2005 "A practical guide for the validation, quality control, and uncertainty assessment of an alternative oenological analysis method".

**COMPENDIUM OF INTERNATIONAL ANALYSIS OF METHODS -
OIV**

**Method of determination of biogenic amines in wine
by high-performance liquid chromatography
with photodiode array detection**

Method OIV-MA-AS315-26

Type IV method

**Method of determination of biogenic amines in wine by
high-performance liquid chromatography with
photodiode array detection**

OIV-OENO 457-2014

1. Scope

This method is applicable to the analysis of biogenic amines in wines:

Amines	Scope
Histamine	0.500 to 20 mg/L
Methylamine	0.250 to 20 mg/L
Ethylamine	0.450 to 20 mg/L
Tyramine	0.235 to 20 mg/L
Putrescine	0.098 to 20 mg/L
Cadaverine	0.480 to 20 mg/L
Phenethylamine (or Phenylethylamine)	0.096 to 20 mg/L
Isoamylamine	0.020 to 20 mg/L

2. Definition

The word biogenic means "created by life". The term "biogenic amines" is therefore given to all the amines produced by the metabolism of living, animal, plant, or microbial cells. Biogenic amines in wine are mainly of microbial origin. The main ones are histamine, putrescine, cadaverine, and tyramine.

**COMPENDIUM OF INTERNATIONAL ANALYSIS OF METHODS -
OIV**

**Method of determination of biogenic amines in wine
by high-performance liquid chromatography
with photodiode array detection**

Method of determination of biogenic amines in wine
by high-performance liquid chromatography
with photodiode array detection

3. Principle

The biogenic amines studied here are primary, secondary, tertiary, aliphatic, or aromatic amines. However, only aromatic amines absorb UV. This is because the detection of molecules by UV requires the presence of a chromophore in the molecule, usually a sequence of conjugated double bonds.

In order to use the HPLC/DAD, it is necessary to couple a chromophore to the biogenic amines. To do so, diethyl 2-(ethoxymethylene)malonate (DEEMM) is used which, by alkylation, also known as derivatisation, enables biogenic amines to be obtained that are visible by diode array detector [1].

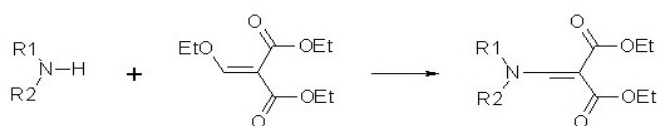

Derivatisation reaction

NB: The yield of the derivatisation is calculated by adding an internal standard (2,4,6-Trimethylphenethylamine hydrochloride or 2,4,6 TPA). Each of the biogenic amines is quantified against a standard range.

**COMPENDIUM OF INTERNATIONAL ANALYSIS OF METHODS -
OIV**

**Method of determination of biogenic amines in wine
by high-performance liquid chromatography
with photodiode array detection**

4. Reagents and Products

4.1 List of reagents

Product references:

	Product	CAS	Purity
4.1.1	Histamine	51-45-6	≥99%
4.1.2	Methylamine	74-89-5	>99.5%
4.1.3	Ethylamine	557-66-	97%
4.1.4	Tyramine	60-19-5	≥98%
4.1.5	Putrescine (diaminobutane)	333-93-	≥98%
4.1.6	Cadaverine (diaminopentane)	1476-	≥99%
4.1.7	Phenethylamine	64-04-0	≥99%
4.1.8	Isoamylamine	107-85-7	99%
4.1.9	Boric acid	10043-	≥98.5%
4.1.10	Sodium hydroxide	1310-73-	≥98%
4.1.11	Sodium azide	26628-	≥99.5%
4.1.12	2,4,6-Trimethylphenethylamine	3167-10-	97%
4.1.13	DEEMM (Diethyl 2-	87-13-8	97%
4.1.14	Glacial acetic acid	64-19-7	≥99.7%
4.1.15	Methanol HPLC	67-56-1	≥99.9%
4.1.16	Acetonitrile HPLC	75-05-8	≥99.93%
4.1.17	Hydrochloric acid	7646-01-	≥37%
4.1.18	Ultrapure water (18 MΩ)		

**COMPENDIUM OF INTERNATIONAL ANALYSIS OF METHODS -
OIV**

**Method of determination of biogenic amines in wine
by high-performance liquid chromatography
with photodiode array detection**

5. Internal standard solution

Preparation of a 2 g/L solution:

Weigh 20 mg of 2, 4, 6-Trimethylphenethylamine hydrochloride (4.1.12)
Dissolve in 10 mL of 0.1 M HCl (5.1)

Storage

The solution is kept at room temperature.

5.1 0.1 M HCL solution

Preparation of a 0.1 M HCl solution:

Take a sample of approximately 900 ml of ultrapure water (4.1.18) using a graduated cylinder (6.13)

Pour approximately 500 mL of ultrapure water (4.1.18) into a 1 L volumetric flask (6.9)

Take a 100 mL sample of 1M HCl (prepared from the commercial product 4.1.17) using a graduated cylinder (6.11)

Pour the 100 mL of 1 M HCl (4.1.17) into the volumetric flask (6.9)

Top up to 1 L with the remaining ultrapure water

Storage

The solution is kept at room temperature.

**COMPENDIUM OF INTERNATIONAL ANALYSIS OF METHODS -
OIV**

**Method of determination of biogenic amines in wine
by high-performance liquid chromatography
with photodiode array detection**

5.2 1M borate buffer

For 100 mL of solution:

Weigh 6.183 g of boric acid (4.1.9)

Dissolve in a beaker (6.2) by adding 80 mL of ultrapure water (measured using the graduated cylinder) (6.11)

Adjust the pH to 9 with a 4N NaOH solution (prepared from the commercial product 4.1.10)

Adjust to 100 mL in a volumetric flask (6.7)

Note: To obtain good dissolution, the crystals of boric acid should dissolve at a pH as low as possible. To do so, NaOH should be added in small doses (by 10 drops from a Pasteur pipette) (6.30) over a period of 3 hours.

Storage

The solution is kept at room temperature.

5.3 HPLC mobile phase

Mobile phase A: 25 mM acetate buffer + 0.02% of sodium azide pH 5.8:

Take a 1.8 L sample of ultrapure water in a 2 L beaker (6.3)

Add 2.86 mL of glacial acetic acid (4.1.14) (thoroughly rinse the tip in the beaker)

Then 0.4 g of sodium azide (4.1.11)

Stir with a magnetic stirrer (6.24)

Adjust the pH to 5.80 with the 4M NaOH using a Pasteur pipette (6.30) (about 6.5 mL)

Adjust to 2000 mL in a 2000 mL volumetric flask (6.10)

**COMPENDIUM OF INTERNATIONAL ANALYSIS OF METHODS -
OIV**

**Method of determination of biogenic amines in wine
by high-performance liquid chromatography
with photodiode array detection**

Mobile phase B: Acetonitrile/Methanol (80/20):

For 2 L of mobile phase

Take a 400 mL sample of methanol (4.1.15) using a graduated cylinder (6.12) and pour it into a 2 L cap bottles (6.20) and add in the same cap bottles 1600 mL sample of acetonitrile (4.1.16) measured using a graduated cylinder (6.14).

Storage

The solutions are kept at room temperature.

5.4 Biogenic amine standard range

Preparation of solutions A :

Stock solution A at 500 mg/L

Weigh about 50 mg (accurately known weight) of histamine (4.1.1), methylamine (4.1.2), ethylamine (4.1.3), tyramine (4.1.4) and putrescine (4.1.5) and dissolve them in the same 100 mL flask (6.7) with 0.1 M HCl (5.1)

Surrogate solution A at 50 mg/L

Take a 25 mL sample of solution A at 500 mg/L and pour into a 250 mL flask (6.8)

Top up to 250 mL with 0.1 M HCl (5.1)

Surrogate solution A at 40 mg/L

Take a 50 mL sample of 0.1 M HCl (5.1) and pour into a 250 mL flask (6.8)

Top up to 250 mL with the surrogate solution A at 50 mg/L

**COMPENDIUM OF INTERNATIONAL ANALYSIS OF METHODS -
OIV**

**Method of determination of biogenic amines in wine
by high-performance liquid chromatography
with photodiode array detection**

Preparation of solutions B

Stock solution B at 500 mg/L

Weigh about 50 mg (accurately known weight) of cadaverine (4.1.6), phenethylamine (4.1.7) and isoamylamine (4.1.8) and dissolve them in the same 100 mL flask (6.7) with 0.1 M HCl (5.1)

Surrogate solution B at 50 mg/L

Take a 25 mL sample of solution B to 500 mg/L and pour into a 250 mL flask (6.8)

Top up to 250 mL with 0.1 M HCl (5.1)

Surrogate solution B at 10 mg/L

Take a 50 mL sample of surrogate solution B at 50 mg/L and pour into a 250 mL flask (6.8)

Top up to 250 mL with 0.1 M HCl (5.1)

Combination of solutions A and B - Standard range

In a 100 mL flask (6.7) add 50 mL of solution A at 40 mg/L using a 50 mL volumetric flask (6.6)

Top up to 100 mL with the solution B at 10 mg/L: you obtain the **solution at 20 (A) / 5 (B) mg/L**

The next table explains how to prepare concentration points for the calibration curve:

Concentration of the initial	Volume of initial solution sampled	Adjusted to 100 mL with a 0.1 M	Concentration of the final
20(A) / 5 (B)	50	50	10 (A) / 2.5 (B)
10(A) / 2.5 (B)	50	50	5 (A) / 1.25 (B)
5(A) / 1.25 (B)	20	80	1 (A) / 0.25 (B)

In this way, four concentrations of biogenic amines are contained in solution A (20, 10, 5 and 1 mg/L), and four concentrations of biogenic amines are contained in solution B (5, 2.5, 1.25 and 0.25 mg/L).

**COMPENDIUM OF INTERNATIONAL ANALYSIS OF METHODS -
OIV**

**Method of determination of biogenic amines in wine
by high-performance liquid chromatography
with photodiode array detection**

Storage The solutions are kept at -20°C .

6. Equipment and apparatus

- 6.1 25 mL Beakers
- 6.2 250 mL Beakers
- 6.3 2000 mL Beakers
- 6.4 10 mL volumetric flasks
- 6.5 25 mL volumetric flasks
- 6.6 50 mL volumetric flasks
- 6.7 100 mL volumetric flasks
- 6.8 250 mL volumetric flasks
- 6.9 1000 mL volumetric flasks
- 6.10 2000 mL volumetric flasks
- 6.11 100 mL graduated cylinder
- 6.12 500 mL graduated cylinder
- 6.13 1000 mL graduated cylinder
- 6.14 2000 mL graduated cylinder
- 6.15 200 μL automatic pipette
- 6.16 1 mL automatic pipette
- 6.17 5 mL automatic pipette
- 6.18 10 mL automatic pipette
- 6.19 Tips for 1 mL, 5 mL and 10 mL automatic pipette
- 6.20 2-litre cap bottles
- 6.21 Pyrex 10 mL hydrolysis tubes with screw top
- 6.22 2 mL screw cap bottles adapted to the auto-sampler
- 6.23 Scales for weighing from 0 to 205 g
- 6.24 Magnetic stirrer
- 6.25 High-performance liquid chromatography (HPLC)
- 6.26 Data acquisition software
- 6.27 DAD detector (diode array)
- 6.28 Octadecyl-type column (for example HP® C18 - HL, 250 mm x 4.6 mm, 5 μm).
- 6.29 Dry bath at 70°C
- 6.30 Pasteur pipette
- 6.31 Ultrasonic bath

**COMPENDIUM OF INTERNATIONAL ANALYSIS OF METHODS -
OIV**

**Method of determination of biogenic amines in wine
by high-performance liquid chromatography
with photodiode array detection**

7. Sampling (sample preparation)

This method does not require special sampling in that 1 mL of wine to be analysed is collected and deposited directly into a Pyrex 10 mL hydrolysis tube with a screw cap (6.21) (see procedure).

However, it is recommended to carry out the derivatisation reaction with DEEMM on receipt of the sample because the histamine concentration in wine may reduce over time.

8. Procedure

8.1 Test sample

The manipulation must be done under a fume hood because of the toxicity of certain of the reagents.

If the buffer contains borate crystals, heat it to 50°C while stirring (lower initially, until the solution has heated up).

To avoid any risk of adsorption on the tips of the automatic pipettes, it is advisable to use the micropipette as follows:

- Pre-wet the cone once with the solution to be sampled
- Add the solution to the recipient without rinsing the tip with the contents of the recipient unless otherwise specified

Shake the solutions well before use (especially the frozen wine)

In a Pyrex 10 mL hydrolysis tube with a screw cap (6.21), introduce using suitable micropipettes:

- 1.75 mL of borate buffer (5.2)
- 750 µL of methanol (4.1.15)
- 1 mL of the sample to be derivatised (1 mL automatic pipette) (6.16)

**COMPENDIUM OF INTERNATIONAL ANALYSIS OF METHODS -
OIV**

**Method of determination of biogenic amines in wine
by high-performance liquid chromatography
with photodiode array detection**

- 40 µL of the internal standard (2,4,6 TPA to 2 g/L) (5.1)
- 30 µL of DEEMM (4.1.13)

Close the tube (fully tighten to avoid any evaporation) and shake manually.

Turn on the dry bath (6.29) to 70°C.

Place the tube in the ultrasonic bath (6.31) for 30 minutes (2 times 15 minutes, stirring every 5 minutes). Always use a plastic rack suitable for the water bath because the derivatisation is unsatisfactory when a metal rack is used.

Heat the reaction mixture to 70°C for 1h in the dry bath (6.29) to degrade the surplus DEEMM.

Turn off the dry bath

After the reaction mixture has returned to room temperature, fill the 2 mL bottles using Pasteur pipettes (6.30) (change Pasteur pipette with each tube). Shake the tubes manually before sampling.

8.2 Operating conditions

The operating conditions below are given as an example.

Mobile phase:

- A: 25 mM acetate buffer + 0.02% of sodium azide pH 5.8 :
- B: Acetonitrile/Methanol (80/20):

**COMPENDIUM OF INTERNATIONAL ANALYSIS OF METHODS -
OIV**

**Method of determination of biogenic amines in wine
by high-performance liquid chromatography
with photodiode array detection**

Gradient elution as follows, with a flow rate of 0.9 mL/min:

Time (min)	% A	% B
0	90	10
5	90	10
10	83	17
35	60	40
43	28	72
48	18	82
52	0	100
57	0	100

Column temperature: 15°C

Detection wavelength: 280 nm

Flow rate: 0.9 ml/min

Volume injected: 50 µL

Analysis time: 57 minutes

Identification of biogenic amines:

The biogenic amines are identified by their retention time. To do so, each biogenic amine was analysed individually in order to determine its retention time (Tr).

Amines		Average Tr (min)
Histamine	HI	25.46
Methylamine	ME	33.11
Ethylamine	ET	39.00
Tyramine	TY	41.50
Putrescine	PU	46.00
Cadaverine	CA	48.00
Phenethylamine	PH	48.75
Isoamylamine	IS	50.25
Internal standard	2,4,6-TPA	54.75

**COMPENDIUM OF INTERNATIONAL ANALYSIS OF METHODS -
OIV**

**Method of determination of biogenic amines in wine
by high-performance liquid chromatography
with photodiode array detection**

9. Calculations (Results)

Bias caused by the uncertainty on the derivatisation yield and the injection volume can be corrected using the internal standard.

Once the value of the peak has been corrected, the concentration of biogenic amine is calculated based on the slope value of the standard range of the corresponding biogenic amine. To do so, for each series of analyses a standard range is also derivatised and injected.

The results are expressed in mg/L to one figure after the decimal point.

10. Quality Control

Quality controls can be carried out with certified reference materials, wines whose characteristics are derived from consensus or wines to which standard additions have been regularly made during the analytical series and in accordance with the accompanying control charts.

11. Characteristics of the method: intralaboratory validation parameters

The validation parameters were determined according to [4].

11.1 Linearity

The approach chosen for the study of linearity is that of comparing the residual standard deviations from a linear regression model and a second-order polynomial regression model.

This study was conducted on two different wines spiked with biogenic amines at concentrations of 0, 1, 5, 10, and 20 mg / L (solution A) and 0, 0.25, 1.25, 2.5, and 5 mg/L (solution B).

Summary of the results for biogenic amines:

biogenic Amine	S _{res} Linear	S' _{res} Order	DS 2	PG	F (5%)	Conclusion
----------------	-------------------------	-------------------------	------	----	--------	------------

**COMPENDIUM OF INTERNATIONAL ANALYSIS OF METHODS -
OIV**

**Method of determination of biogenic amines in wine
by high-performance liquid chromatography
with photodiode array detection**

		2				
Methylamine	0.766	0.606	3.218	8.757	4.75	Linear
Ethylamine	0.371	0.371	0.140	1.014		Linear
Tyramine	1.065	1.065	1.135	1.000		Linear
Putrescine	0.524	0.523	0.286	1.043		Linear
Cadaverine	0.276	0.267	0.134	1.881		Linear
Phenethylamine	0.251	0.248	0.082	1.328		Linear
Isoamylamine	0.216	0.215	0.055	1.199		Linear
Histamine	0.591	0.589	0.316	1.084		Linear

11.2 Specificity

The principle of specificity measurement consists in examining the regression line $r = a + bv$ and verifying that slope b is equal to 1 ($T_{obs} < T_{critical}$) and that intercept point a is equal to 0 ($T'_{obs} < T_{critical}$). The hypotheses are tested using a t-test associated with the 1% risk of error.

The value of $T_{critical}$, bilateral [p=2, 1%] associated with the 1% risk of error for 3 degrees of freedom is 4.541.

Summary of the results for biogenic amines

biogenic Amine	Wine A		Wine B		Wine C		Wine D	
	T_{obs}	T'_{obs}	T_{obs}	T'_{obs}	T_{obs}	T'_{obs}	T_{obs}	T'_{obs}
Methylamine	4.482	2.321	2.933	0.013	1.563	0.007	5.199	2.864
Ethylamine	0.411	0.002	0.081	0.010	0.546	10.556	0.169	2.537
Tyramine	1.834	0.005	0.636	0.005	2.151	4.485	3.420	37.419
Putrescine	7.605	0.041	0.604	0.000	3.257	0.064	2.135	0.011
Cadaverine	5.499	0.033	1.719	1.314	10.929	0.049	8.466	0.026
Phenethylamine	3.348	0.01	1.26	0.00	10.23	0.034	5.925	0.009

**COMPENDIUM OF INTERNATIONAL ANALYSIS OF METHODS -
OIV**

**Method of determination of biogenic amines in wine
by high-performance liquid chromatography
with photodiode array detection**

ne		6	5	1	8			
Isoamylamine	12.98 0	0.01 6	2.29 7	0.00 4	12.99 6	0.020	11.12 1	0.000
Histamine	4.978	0.25 0	1.22 2	0.00 6	3.128	0.014	1.229	0.004

11.3 Repeatability

For this repeatability study, seven different red wines were selected, and three different repetitions were performed on each. Concentrations were from 0.5 mg/L to 15 mg/L depending on the biogenic amine and the wine.

biogenic Amine	S _r (mg/L)	r (mg/L)	Validation range (mg/L)
Methylamine	0.335	0.937	3 - 16
Ethylamine	0.173	0.486	2 - 7
Tyramine	0.276	0.773	2 - 20
Putrescine	0.500	1.400	7 - 26
Cadaverine	0.025	0.069	0.2 - 0.8
Phenethylamine	0.028	0.079	0.3 - 1.1
Isoamylamine	0.017	0.048	0.1 - 0.8
Histamine	0.108	0.303	5 - 16

11.4 Reproducibility

For this reproductibility study, three different red wines were selected, and two repetitions were performed with each.

biogenic Amine	S _r (mg/L)	R (mg/L)	Validation range (mg/L)
Methylamine	0.533	1.492	3 - 16
Ethylamine	0.884	2.475	2 - 7
Tyramine	0.341	0.955	2 - 20

**COMPENDIUM OF INTERNATIONAL ANALYSIS OF METHODS -
OIV**

**Method of determination of biogenic amines in wine
by high-performance liquid chromatography
with photodiode array detection**

Putrescine	0.419	1.172	7 - 26
Cadaverine	0.172	0.482	0.2 - 0.8
Phenethylamine	0.053	0.150	0.3 - 1.1
Isoamylamine	0.056	0.157	0.1 - 0.8
Histamine	1.333	3.732	5 - 16

**COMPENDIUM OF INTERNATIONAL ANALYSIS OF METHODS -
OIV**

**Method of determination of biogenic amines in wine
by high-performance liquid chromatography
with photodiode array detection**

11.5 Limits of detection (LOD) and limits of quantification (LOQ)

According to an intralaboratory study using the method of successive dilutions from a solution to 0.5 mg/L serially diluted to 0.01 mg/L :

Amines		LD (mg/L)	LQ (mg/L)
Histamine	HI	0.167	0.500
Methylamine	ME	0.083	0.250
Ethylamine	ET	0.150	0.450
Tyramine	TY	0.078	0.235
Putrescine	PU	0.033	0.098
Cadaverine	CA	0.160	0.480
Phenethylamine	PH	0.032	0.096
Isoamylamine	IS	0.007	0.020

12. Bibliography

- [1] Gomez-Alonzo S., Hermosin-Gutierrez I., Garcia-Romero E., 2007. Simultaneous HPLC analysis of biogenic amines, amino acids, and ammonium Ion as Aminoenone derivatives in wine and beer samples. *Journal of Agricultural and Food Chemistry*, 55, 608-613.
- [2] Tricard C., Cazabeil J.-M., Salagoïti M.H. (1991): dosage des amines biogènes dans les vins par HPLC, *Analisis*, 19, M53-M55.
- [3] RECUEIL DES METHODES INTERNATIONALES D'ANALYSES - OIV, Amines biogènes par HPLC, Méthode OIV-MA-AS315-18 , Analyse des amines biogènes des moûts et des vins par HPLC (Résolution OIV-Oeno 346-2009).
- [4] "Guide pratique pour la validation, le contrôle qualité et l'estimation de l'incertitude d'une méthode d'analyse œnologique alternative". Oeno Resolution 10/2005. OIV. October 2005. www.oiv.int.

**Analysis of volatile compounds in wines by gas
chromatography**

OIV-OENO 553-2016

OIV-OENO 606-2018

1 – Object

This method is applicable to the analysis of volatile compounds in wines containing less than 20 g/L sugar.

For wines with a sugar content higher than 20 g/L and for mistelles, prior distillation (identical to that practised to obtain the ABV) is necessary; however distillation sometimes removes a significant part of the compounds.

2 – Scope of application

The present method may be used for the quantification of the following compounds (non-exhaustive list):

ethanal,
ethyl acetate,
methanol,
butan-2-ol,
propan-1-ol,
2-methylpropan-1-ol,
isoamyl acetate,
butan-1-ol,
2-methylbutan-1-ol,
3-methylbutan-1-ol,

¹ Type II for ethyl acetate, propan-1-ol, 2-methylpropan-1-ol, butan-1-ol, 2-methylbutan-1-ol, 3-methylbutan-1-ol, acetoïn, ethyl lactate, hexan-1-ol, 3-ethoxypropanol, ethyl octanoate, butyrolactone, diethyl succinate and 2-phenyl ethanol.

Type III for methanol.

Type IV for other products (ethanal, butan-2-ol, butane-2,3-diol (levo + meso), propane-1,2-diol, diethyl malate).

pentan-1-ol,
acetoin,
ethyl lactate,
hexan-1-ol,
3-ethoxypropanol,
ethyl octanoate,
furfuraldehyde,
(2R,3R)-butane-2,3-diol,
(2R,3S)-butane-2,3-diol,
propane-1,2-diol,
butyrolactone,
diethyl succinate,
hexanoic acid (semi-quantitative),
2-phenylethanol,
diethyl malate,
octanoic acid (semi-quantitative),
decanoic acid (semi-quantitative).

Note: diacetyl and acetic acid cannot be quantified by this method yet they appear in the chromatograms.

3 – Principle

Volatile compounds are quantified by gas chromatography after direct injection of the sample, added with an internal standard, into a capillary column coated with a bonded polar phase and detection using flame ionisation.

4 – Reagents and products

The quantities and method of preparation are given by way of example and may be adapted as necessary to the types of wine.

4.1 - Demineralised water (e.g. ISO 3696 type II or resistivity $\geq 18 \text{ M}\Omega\cdot\text{cm}$);

4.2 - ethanol [CAS no. 64-17-5], purity $\geq 96\%$;

4.3 - high-purity hydrogen for GC (e.g. $\text{H}_2\text{O} \leq 4 \text{ ppm}$; $\text{O}_2 \leq 2 \text{ ppm}$; $\text{C}_n\text{H}_m \leq 0.5 \text{ ppm}$; $\text{N}_2 \leq 4 \text{ ppm}$);

4.4 - high-purity helium for GC ($\text{H}_2\text{O} \leq 3 \text{ ppm}$; $\text{O}_2 \leq 2 \text{ ppm}$; $\text{C}_n\text{H}_m \leq 1 \text{ ppm}$; $\text{N}_2 \leq 5 \text{ ppm}$);

4.5 - high-purity compressed air for GC;

4.6 - ethanal [CAS no. 75-07-0], purity $\geq 99\%$;

4.7 - ethyl acetate [CAS no. 141-78-6], purity $\geq 99.5\%$;

4.8 - methanol [CAS no. 67-56-1], purity $\geq 99.8\%$;

4.9 - diacetyl [CAS no. 431-03-08], purity $\geq 99\%$;

- 4.10 - butan-2-ol [CAS no. 15892-23-6], purity \geq 99.5%;
- 4.11 - propan-1-ol [CAS no. 71-23-8], purity \geq 99.5%;
- 4.12 - 2-methylpropan-1-ol [CAS no. 78-83-1], purity \geq 99.5%;
- 4.13 - isoamyl acetate [CAS no. 123-92-2], purity \geq 97%;
- 4.14 - butan-1-ol [CAS no. 71-36-3], purity \geq 99.5%;
- 4.15 - 4-methylpentan-2-ol (internal standard) [CAS no. 108-11-2], purity \geq 99%;
- 4.16 - 2-methylbutan-1-ol [CAS no. 137-32-6], purity \geq 99%;
- 4.17 - 3-methylbutan-1-ol [CAS no. 125-51-3], purity \geq 99.5%;
- 4.18 - pentan-1-ol [CAS no. 71-41-0], purity \geq 99%;
- 4.19 - acetoin [CAS no. 513-86-0], purity \geq 96%;
- 4.20 - ethyl lactate [CAS no. 687-47-8], purity \geq 98%;
- 4.21 - hexan-1-ol [CAS no. 111-27-3], purity \geq 99.0%;
- 4.22 - 3-ethoxypropanol [CAS no. 111-35-3], purity \geq 97%;
- 4.23 - ethyl octanoate [CAS no. 106-32-1], purity \geq 99%;
- 4.24 - furfuraldehyde [CAS no. 98-01-1], purity \geq 99.0%;
- 4.25 - acetic acid [CAS no. 64-19-7], purity \geq 99%;
- 4.26 - (2R,3R)- and (2R,3S)-butane-2,3-diol [CAS no. 513-85-9], purity \geq 98%;
- 4.27 - propane-1,2-diol [CAS no. 57-556], purity \geq 99.5%;
- 4.28 - butyrolactone [CAS no. 96-48-0], purity \geq 99%;
- 4.29 - diethyl succinate [CAS no. 123-25-1], purity \geq 99%;
- 4.30 - hexanoic acid [CAS no. 142-62-1], purity \geq 99.5%;
- 4.31 - 2-phenylethanol [CAS no. 60-12-8], purity \geq 99%;
- 4.32 - diethyl malate [CAS no. 7554-12-3], purity \geq 97%;
- 4.33 - octanoic acid [CAS no. 124-07-2], purity \geq 99.5%;
- 4.34 - decanoic acid [CAS no. 334-48-5], purity \geq 99.5%.

Note: diacetyl and acetic acid cannot be quantified by this method yet they appear in the chromatograms.

Preparation of reagent solutions (the quantities are given by way of example and may be adapted as necessary to the types of matrix to be analysed)

4.35 - 10% Aqueous-alcoholic mixture to be made up with ethanol (4.2) and water (4.1).

4.36 - Internal standard solution

Transfer 1 mL 4-methylpentan-2-ol (4.15) into a 100-mL flask (5.2). Fill up to the calibration mark with ethanol (4.2). Divide into flasks on which the date of preparation is noted. Keep refrigerated.

4.37 - Internal or external reference wine (a CRM (Certified Reference Material) wine or a wine used as a reference material from a proficiency-testing programme between laboratories for example).

RECUEIL INTERNATIONAL DES METHODES D'ANALYSES – OIV
Analysis of volatile compounds in wines by gas chromatography

4.38 - Stock calibration solution

The compounds are individually weighed at ± 1 mg (nominal weights given in the table below) using a precision balance (5.4). In order to avoid losses through evaporation, quickly add a small amount of ethanol (4.2). Mix and pour into a 1-L flask (5.3). Rinse with ethanol. Add 2.5 mL 4-methylpentan-2-ol (4.15). Make up to 1 L with ethanol (4.2) and mix. Divide into flasks and store in the freezer. Record the exact weights.

Compound	Nominal weight (mg)	Final concentration in the working calibration solution 4.39 (mg/L)	Compound	Nominal weight (mg)	Final concentration in the working calibration solution 4.39 (mg/L)
Ethanal (4.6)	500	50	Hexan-1-ol (4.21)	300	30
Ethyl acetate (4.7)	1500	150	3-Ethoxypropanol (4.22)	160	16
Methanol (4.8)	650	65	Furfuraldehyde (4.24)	50	5
Diacetyl (4.9)	50	5	Ethyl octanoate (4.23)	120	12
Butan-2-ol (4.10)	160	16	Acetic acid (5.25)	5000	500
Propan-1-ol (4.11)	350	35	Butane-2,3-diol (4.26)	4000	400
2-Methylpropan-1-ol (4.12)	240	24	Propane-1,2-diol (4.27)	1000	100
Isoamyl acetate (4.13)	250	25	Butyrolactone (4.28)	50	5
Butan-1-ol (4.14)	160	16	Diethyl succinate (4.29)	500	50
2-Methylbutan-1-ol (4.16)	160	16	Hexanoic acid (4.30)	250	25
3-Methylbutan-1-ol (4.17)	1000	100	2-Phenylethanol (4.31)	500	50
Pentan-1-ol (4.18)	160	16	Diethyl malate (4.32)	1000	100
Acetoin (4.19)	250	25	Octanoic acid (4.33)	500	50
Ethyl lactate (4.20)	1500	150	Decanoic acid (4.34)	750	75

4.39 - Working calibration solution

Just before use, dilute the stock calibration solution (4.38) ten times.

5 – Apparatus

5.1 - 20-mL volumetric flasks (class A);

5.2 - 100-mL volumetric flasks (class A);

5.3 - 1-L volumetric flasks (class A);

5.4 - precision balance with an accuracy of ± 1 mg;

5.5 - gas chromatograph equipped with:

"split-splitless" injector,

autosampler (optional),

detector: flame ionisation (FID);

5.6 - fused-silica capillary column:

Carbowax 20 M type with a bonded polar phase,

50 m in length,

internal diameter of 0.32 mm,

film thickness of 0.45 μm .

Note: other systems may be used on condition that they are capable of satisfactorily separating the different compounds.

6 – Preparation of the samples

Conduct a preliminary degassing of sparkling wine samples (for example, by first taking a sample using an automatic pipette and collecting it in a tube).

Distil the wines containing more than 20 g/L of sugar and the mistelles prior to preparation.

Introduce the sample into a 20-mL flask (5.1). Add 0.5 mL internal standard solution (4.36) and fill up to the calibration mark with wine.

7 – Procedure

Analyse using the gas chromatograph (5.5) equipped with a capillary column (5.6).

Analytical conditions (given by way of example):

Carrier gas (4.4): $P_{\text{helium}} = 90$ kPa

Note: another carrier gas such as hydrogen may be used, but nitrogen is best avoided.

Septum flow rate: 2.5 mL/min

Split flow rate: 40 mL/min

Split mode of injection

Volume injected: 1 µL

Temperature of the injector: 200 °C

Detector: FID (flame ionisation)

Detector temperature at 250 °C

Flame: P_{hydrogen (4.3)} = 50 kPa and P_{air (4.5)} = 130 kPa

Temperature programming:

. temp. 1 = 32 °C at 2.5 °C/min, up to 80 °C - t₁ = 0 min

. temp. 2 = 80 °C at 4 °C/min, up to 170 °C - t₂ = 20 min

. temp. 3 = 170 °C at 10 °C/min, up to 220°C - t₃ = 20 min

Calibration

Inject the working calibration solution (4.39) before each analysis series.

Calculation of response factors:

$$RF_i = (\text{area}_i \times C_{C_{IS}}) / (C_{C_i} \times \text{area}_{IS})$$

C_{C_i} = concentration of the constituent of the calibration solution

Area_i = area of the constituent of the calibration solution

C_{C_{IS}} = concentration of the internal standard in the calibration solution

Area_{IS} = area of the internal standard in the calibration solution

It is also possible to use a calibration curve.

By way of example, chromatograms of a standard solution and a wine sample are given in the Annexes.

8 – Calculations

In the case of use of a response factor, calculation of the concentrations is as follows:

$$C_{C_i} = (\text{area}_i \times C_{C_{IS}}) / (RF_i \times \text{area}_{IS}).$$

9 – Precision

See Annex C.

10 – Quality assurance and control

Traceable to the international references through mass, volume and temperature.

RECUEIL INTERNATIONAL DES METHODES D'ANALYSES – OIV
Analysis of volatile compounds in wines by gas chromatography

Synthetic mixtures or samples coming, for instance, from proficiency ring test are used as internal quality control. A control chart may be used.

11 – Results

Express concentrations in mg/L to the number of decimal places indicated below.

Analytical parameters	No. of decimal places	Analytical parameters	No. of decimal places
Ethanal	0	Ethyl lactate	0
Ethyl acetate	0	Hexan-1-ol	1
Methanol	0	3-Ethoxypropanol	0
Butan-2-ol	1	Ethyl octanoate	0
Propan-1-ol	0	Furfuraldehyde	1
2-Methylpropan-1-ol	0	(2R,3R)-Butane-2,3-diol	0
Isoamyl acetate	1	(Meso)-butane-2,3-diol	0
Butan-1-ol	1	Propane-1,2-diol	0
2-Methylbutan-1-ol	0	Butyrolactone	0
3-Methylbutan-1-ol	0	Diethyl succinate	0
Pentan-1-ol	1	2-Phenylethanol	0
Acetoin	0	Diethyl malate	0

Annex A
Bibliography

BERTRAND A., GUEDES DE PINHO P. and ANOCIBAR BELOQUI A. (1994).
Les constituants majoritaires du vin, FV 971, OIV, 15 pages.

ANNEX B
Example chromatograms

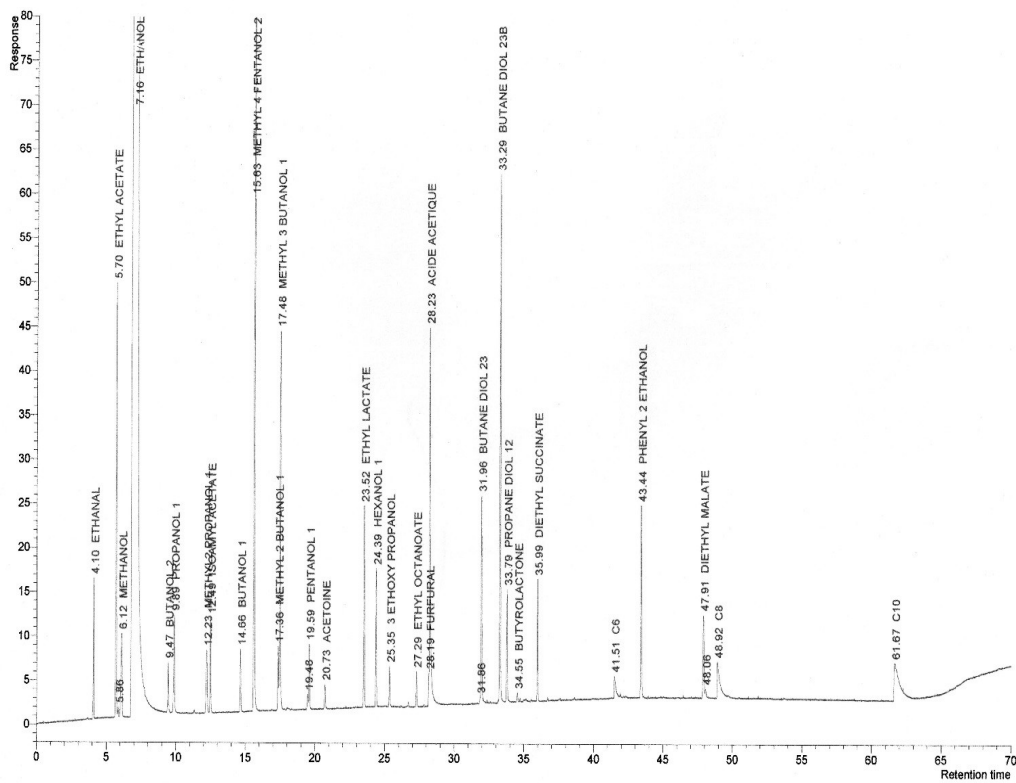

Figure 1: chromatogram of a standard solution of volatile compounds

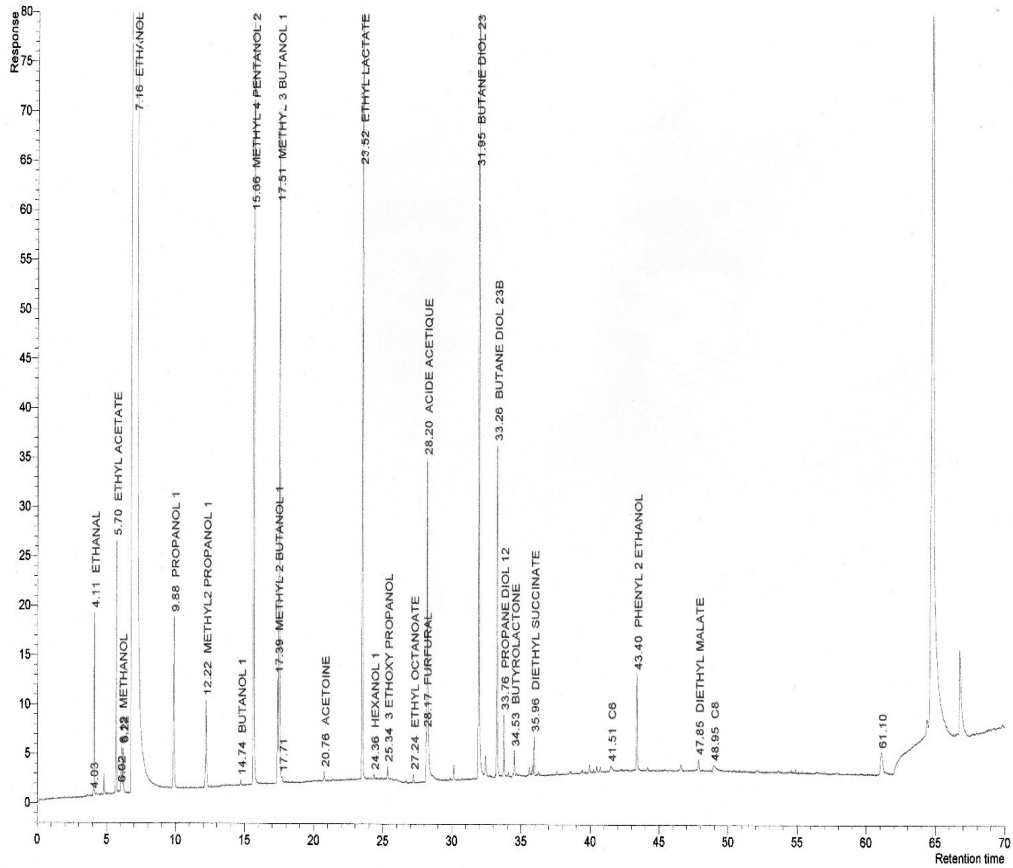

Figure 2 : chromatogram of volatile compounds in a white wine (sugar < 15 g/L)

Annexe C

C1 – Organisation of the study - Samples

This study was carried out by the Comité Interprofessionnel du Vin de Champagne in Epernay. A prevalidation occurred during October/December 2015 and actual interlaboratory during March/April 2016.

The trial involved 11 samples: two white wines identified B and E, two red wines identified C and F and one rosé wine identified A (blindly replicated) + one of the samples spiked with butan-2-ol, butan-1-ol, acetoin, hexan-1-ol and diethyl malate (identified D).

C2 - Fidelity

13 laboratories participated in the interlaboratory study:

Autoridade de Segurança Alimentar e Económica, Lisbon, Portugal;

Bundesinstitut für Risikobewertung, Berlin, Germany;

Bureau National Interprofessionnel du Cognac, Cognac, France;

Comité Interprofessionnel du vin de Champagne, Epernay, France;

Czech Agriculture and Food Inspection Authority, Brno, Czech Republic;

Instituto dos Vinhos do Douro e do Porto, Porto, Portugal;

Laboratoire DUBERNET, Montredon Corbières, France;

Laboratorio Arbitral Agroalimentario, Madrid, Spain;

Landesuntersuchungsamt, Mainz, Germany;

Miguel Torres S.A.- Finca, Barcelona, Spain;

Service Commun des Laboratoires Bordeaux-Pessac (SCL MINEFI), Pessac, France;

Service Commun des Laboratoires Montpellier (SCL MINEFI), Montpellier, France;

Union Nationale de Groupements des Distillateurs d'alcool (UNGDA), Malakoff, France.

The results were evaluated according to the OIV protocol (Collaborative study OIV-MA-AS1-07:R2000).

RECUEIL INTERNATIONAL DES METHODES D'ANALYSES – OIV
Analysis of volatile compounds in wines by gas chromatography

ISO 5725-2 §7.5 recommends to look for any functional relationship between the fidelity values and the content, which is expressed by the graphs below the data tables for each product.

C3 - Results tables

compound	r	R
ethyl acetate	$0.18x - 1.8$	$0.33x - 1.7$
methanol	$0.22x - 4.3$	$0.28x - 3.2$
propan-1-ol	4 mg/l	7 mg/L
2-methylpropan-1-ol	$0.20x - 1.4$	$0.36x - 0.7$
butan-1-ol	$0.07x + 0.2$	$0.14x + 0.3$
2-methylbutan-1-ol	$0.23x - 2.7$	$0.40x - 5.0$
3-methylbutan-1-ol	$0.35x - 35.7$	$0.45x - 41.8$
acetoin	$0.14x + 1.2$	$0.33x + 2.1$
ethyl lactate	$0.23x - 1.6$	$0.29x + 4.2$
hexanol	$0.07x + 0.3$	$0.10x + 0.8$
3-ethoxypropanol	$0.59x - 0.4$	$0.46x + 0.4$
ethyl octanoate	0.5 mg/l	0.7 mg/l
butyrolactone	$0.25x + 0.8$	$0.20x + 4.1$
diethyl succinate	$0.31x + 0.8$	$0.55x + 0.4$
2-phenylethanol	$0.24x + 0.3$	$0.50x - 2.6$

where x is the measured concentration

**Ethyl acetate - Fidelity
repeatability and reproducibility**

	wine A	wine B	wine C	wine D	wine E	wine F
Method	ISO 5725-2	ISO 5725-2	ISO 5725-2	ISO 5725-2	ISO 5725-2	ISO 5725-2
No. of laboratories that submitted results	13	13	13	13	13	13
No. of laboratories that submitted compliant results	13	13	13	13	13	13
No. of laboratories after elimination of outliers	12	12	12	13	12	13
Number of measurement values without outliers	42	42	42	23	42	46
Mean (mg/L)	26.4	60.5	55.5	60.6	25.5	68.4
Repeatability s.d. Sr	1.6	2.6	2.4	1.4	1.1	6.0
RSDr %	5.9	4.2	4.3	2.4	4.3	8.8
Limit of repeatability r	4.5	7.4	6.9	4.5	3.2	17.3
Relative limit of repeatability r%	16.9%	12.2%	12.3%	7.4%	12.5%	25.3%
Reproducibility s.d. SR	2.8	4.7	4.4	8.8	2.2	7.3
RSDR %	10.7	7.7	8.0	14.5	8.5	10.6
Limit of reproducibility R	8.1	13.4	12.6	25.8	6.2	20.7
Relative limit of reproducibility R%	30.5%	22.1%	22.7%	42.6%	24.2%	30.3%
HORRAT R	1.1	0.9	0.9	1.7	0.9	1.2

RECUEIL INTERNATIONAL DES METHODES D'ANALYSES – OIV
Analysis of volatile compounds in wines by gas chromatography

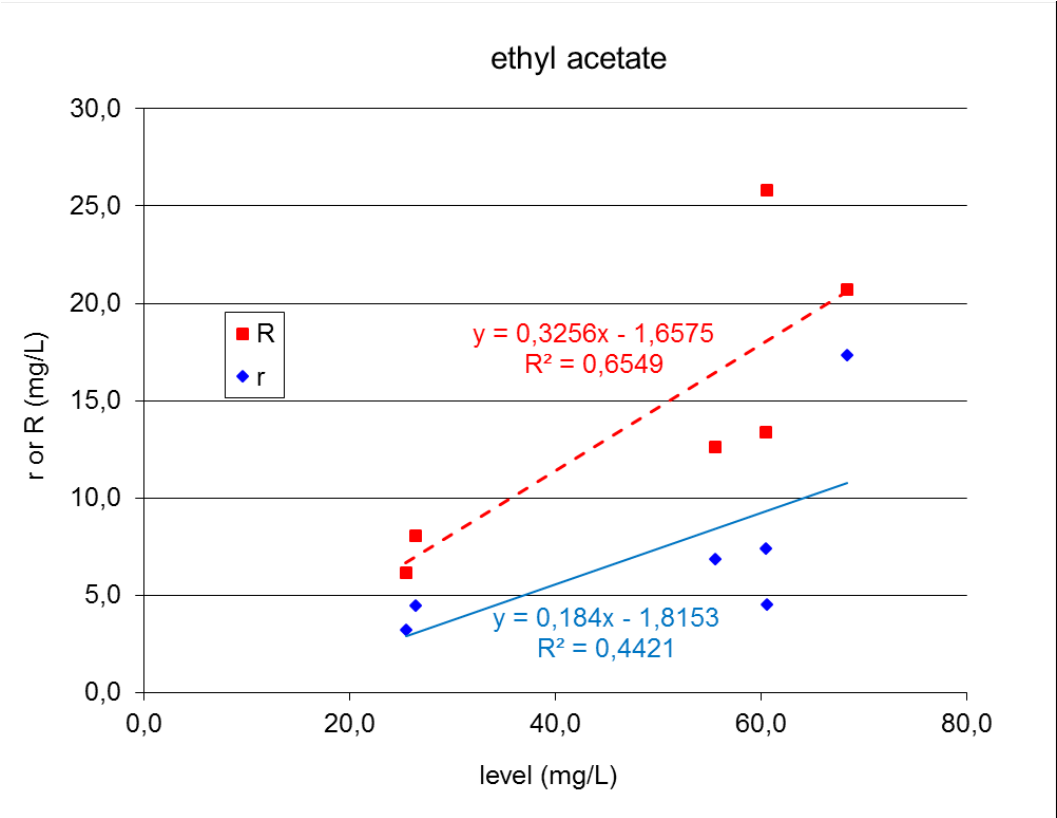

RECUEIL INTERNATIONAL DES METHODES D'ANALYSES – OIV
Analysis of volatile compounds in wines by gas chromatography

**Methanol - Fidelity
repeatability and reproducibility**

	wine A	wine B	wine C	wine D	wine E	wine F
Method	ISO 5725-2	ISO 5725-2	ISO 5725-2	ISO 5725-2	ISO 5725-2	ISO 5725-2
No. of laboratories that submitted results	13	13	13	13	13	13
No. of laboratories that submitted compliant results	13	13	13	13	13	13
No. of laboratories after elimination of outliers	13	13	13	13	13	13
Number of measurement values without outliers	46	46	46	23	46	46
Mean (mg/L)	66.8	57.2	129.8	57.8	59.4	165.6
Repeatability s.d. Sr	3.8	2.6	7.4	3.0	3.3	11.9
RSDr %	5.6	4.5	5.7	5.2	5.5	7.2
Limit of repeatability r	10.8	7.4	21.2	9.5	9.4	34.1
Relative limit of repeatability r%	16.2%	12.9%	16.3%	16.3%	15.8%	20.6%
Reproducibility s.d. SR	5.1	4.6	11.4	4.2	5.4	15.4
RSDR %	7.6	8.1	8.8	7.3	9.0	9.3
Limit of reproducibility R	14.5	13.2	32.5	12.3	15.3	43.9
Relative limit of reproducibility R%	21.7%	23.1%	25.0%	21.3%	25.7%	26.5%
HORRAT R	0.9	0.9	1.1	0.8	1.0	1.3

RECUEIL INTERNATIONAL DES METHODES D'ANALYSES – OIV
Analysis of volatile compounds in wines by gas chromatography

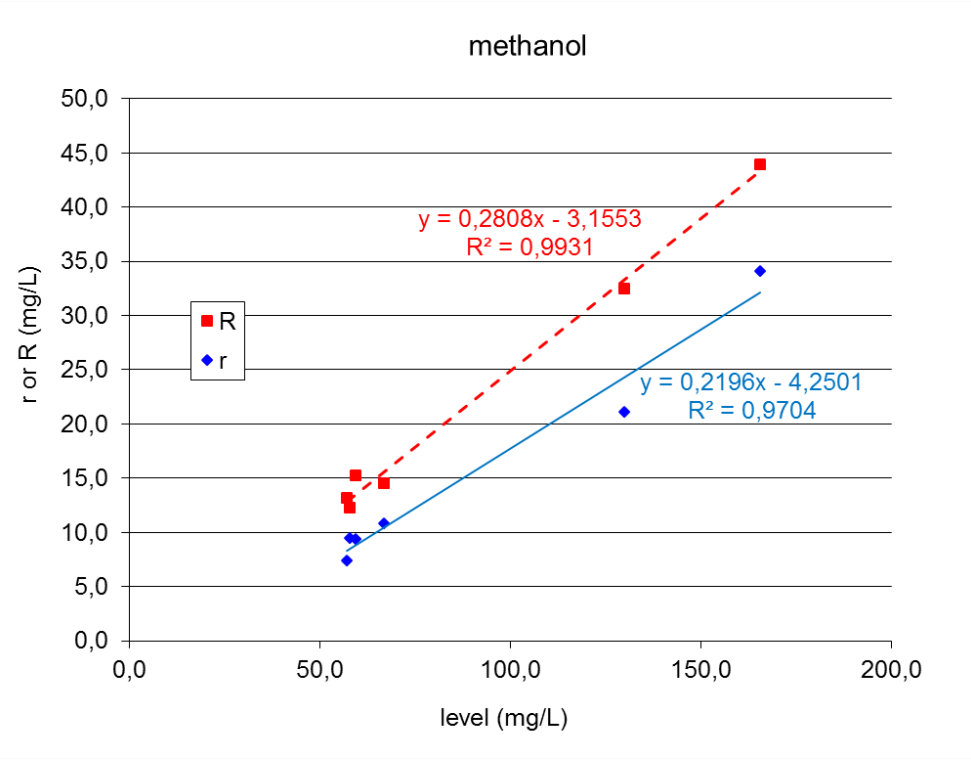

RECUEIL INTERNATIONAL DES METHODES D'ANALYSES – OIV
Analysis of volatile compounds in wines by gas chromatography

Propan-1-ol - Fidelity

repeatability and reproducibility

	wine A	wine B	wine C	wine D	wine E	wine F
Method	ISO 5725-2	ISO 5725-2	ISO 5725-2	ISO 5725-2	ISO 5725-2	ISO 5725-2
No. of laboratories that submitted results	13	13	13	13	13	13
No. of laboratories that submitted compliant results	13	13	13	13	13	13
No. of laboratories after elimination of outliers	13	13	13	13	13	13
Number of measurement values without outliers	46	46	46	23	46	46
Mean (mg/L)	31.1	36.1	39.5	36.7	32.9	22.7
Repeatability s.d. Sr	1.5	1.4	1.8	0.8	1.4	1.5
RSDr %	4.7	3.8	4.6	2.4	4.1	6.8
Limit of repeatability r	4.2	4.0	5.3	2.7	3.9	4.4
Relative limit of repeatability r%	13.4%	11.0%	13.4%	7.4%	11.8%	19.4%
Reproducibility s.d. SR	2.0	2.1	3.0	1.5	2.1	1.9
RSDR %	6.3	5.9	7.5	4.1	6.4	8.3
Limit of reproducibility R	6.7	7.3	10.2	4.4	7.2	6.4
Relative limit of reproducibility R%	21.6%	20.1%	25.7%	11.9%	22.0%	28.3%
HORRAT R	0.7	0.6	0.8	0.4	0.7	0.8

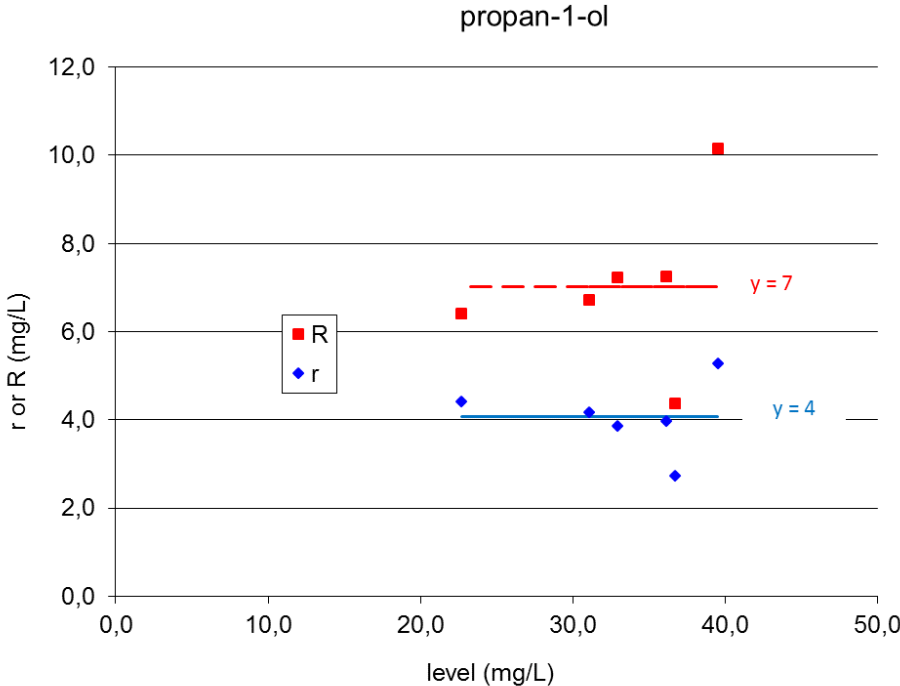

RECUEIL INTERNATIONAL DES METHODES D'ANALYSES – OIV
Analysis of volatile compounds in wines by gas chromatography

**2-methylpropan-1-ol - Fidelity
repeatability and reproducibility**

	wine A	wine B	wine C	wine D	wine E	wine F
Method	ISO 5725-2	ISO 5725-2	ISO 5725-2	ISO 5725-2	ISO 5725-2	ISO 5725-2
No. of laboratories that submitted results	13	13	13	13	13	13
No. of laboratories that submitted compliant results	13	13	13	13	13	13
No. of laboratories after elimination of outliers	13	13	13	12	13	13
Number of measurement values without outliers	46	46	46	21	46	46
Mean (mg/L)	21.2	22.2	40.0	30.8	17.7	49.9
Repeatability s.d. Sr	0.9	1.4	1.6	3.0	0.7	3.3
RSDr %	4.0	6.4	4.1	9.6	3.7	6.5
Limit of repeatability r	2.5	4.1	4.7	9.5	1.9	9.4
Relative limit of repeatability r%	11.6%	18.3%	11.8%	30.8%	10.8%	18.9%
Reproducibility s.d. SR	2.4	2.7	4.6	7.5	1.9	6.1
RSDR %	11.5	12.2	11.5	24.2	10.8	12.3
Limit of reproducibility R	6.9	7.7	13.2	22.0	5.5	17.5
Relative limit of reproducibility R%	32.8%	34.7%	33.0%	71.5%	30.8%	35.1%
HORRAT R	1.1	1.2	1.3	2.5*	1.0	1.4

*presumed outlier, not considered for computation of fidelity.

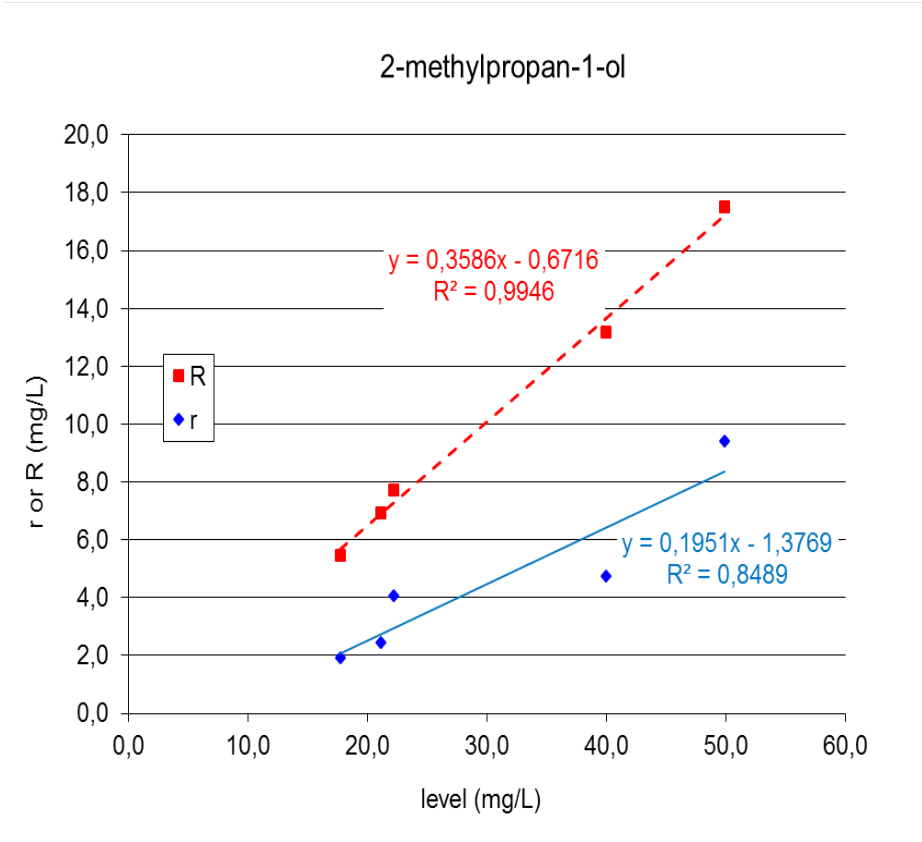

RECUEIL INTERNATIONAL DES METHODES D'ANALYSES – OIV
Analysis of volatile compounds in wines by gas chromatography

**Butan-1-ol – Fidelity
repeatability et reproducibility**

	vin A	vin B	vin C	vin D	vin E	vin F
Method	ISO 5725-2	ISO 5725-2	ISO 5725-2	ISO 5725-2	ISO 5725-2	ISO 5725-2
No. of laboratories that submitted results	13	13	13	13	13	13
No. of laboratories that submitted compliant results	9	8	10	13	9	10
No. of laboratories after elimination of outliers	9	8	10	13	9	10
Number of measurement values without outliers	28	26	34	23	28	32
Mean (mg/L)	0.87	0.87	1.77	11.36	0.81	1.36
Repeatability s.d. Sr	0.05	0.07	0.14	0.29	0.07	0.15
RSDr %	5.5	7.8	8.2	2.6	8.4	11.0
Limit of repeatability r	0.14	0.20	0.42	0.92	0.20	0.44
Relative limit of repeatability r%	16.2%	23.1%	23.9%	8.1%	24.8%	32.1%
Reproducibility s.d. SR	0.14	0.13	0.20	0.67	0.14	0.26
RSDR %	15.6	15.0	11.3	5.9	17.5	19.3
Limit of reproducibility R	0.39	0.38	0.58	1.96	0.41	0.76
Relative limit of reproducibility R%	45.2%	43.9%	32.5%	17.3%	50.9%	55.7%
HORRAT R	1.0	0.9	0.8	0.5	1.1	1.3

RECUEIL INTERNATIONAL DES METHODES D'ANALYSES – OIV
Analysis of volatile compounds in wines by gas chromatography

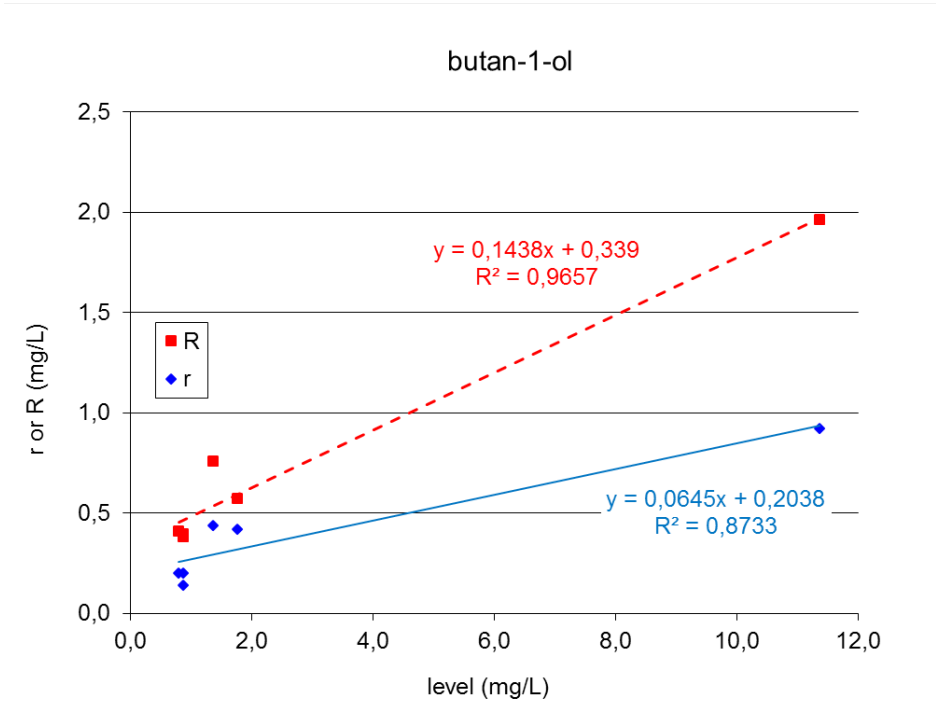

RECUEIL INTERNATIONAL DES METHODES D'ANALYSES – OIV
Analysis of volatile compounds in wines by gas chromatography

**2-methylbutan-1-ol - Fidelity
repeatability and reproducibility**

	wine A	wine B	wine C	wine D	wine E	wine F
Method	ISO 5725-2	ISO 5725-2	ISO 5725-2	ISO 5725-2	ISO 5725-2	ISO 5725-2
No. of laboratories that submitted results	13	13	13	13	13	13
No. of laboratories that submitted compliant results	9	9	9	9	9	9
No. of laboratories after elimination of outliers	9	9	9	9	9	9
Number of measurement values without outliers	32	32	32	16	32	32
Mean (mg/L)	24.3	22.4	47.6	22.6	20.4	52.0
Repeatability s.d. Sr	1.4	1.1	2.2	0.3	0.7	3.8
RSDr %	5.7	4.7	4.6	1.3	3.6	7.3
Limit of repeatability r	4.0	3.1	6.4	1.0	2.2	11.0
Relative limit of repeatability r%	16.6%	13.7%	13.3%	4.3%	10.6%	21.2%
Reproducibility s.d. SR	1.7	1.5	4.7	0.8	1.5	5.7
RSDR %	6.9	6.8	9.9	3.5	7.3	10.9
Limit of reproducibility R	4.8	4.4	13.7	2.4	4.3	16.3
Relative limit of reproducibility R%	19.9%	19.6%	28.6%	10.6%	21.2%	31.4%
HORRAT R	0.7	0.7	1.1	0.4	0.7	1.2

The laboratories that summed the peaks of 2-methylbutan-1-ol and 3-methylbutan-1-ol are excluded.

RECUEIL INTERNATIONAL DES METHODES D'ANALYSES – OIV
Analysis of volatile compounds in wines by gas chromatography

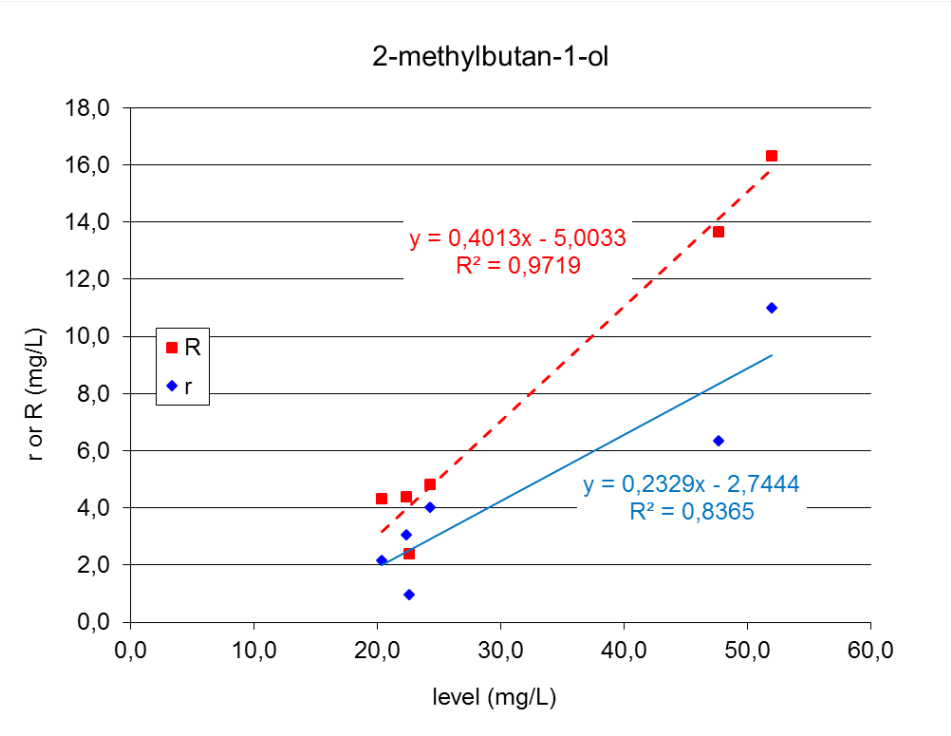

RECUEIL INTERNATIONAL DES METHODES D'ANALYSES – OIV
Analysis of volatile compounds in wines by gas chromatography

**3-methylbutan-1-ol - Fidelity
repeatability and reproducibility**

	wine A	wine B	wine C	wine D	wine E	wine F
Method	ISO 5725-2	ISO 5725-2	ISO 5725-2	ISO 5725-2	ISO 5725-2	ISO 5725-2
No. of laboratories that submitted results	13	13	13	13	13	13
No. of laboratories that submitted compliant results	9	9	9	9	9	9
No. of laboratories after elimination of outliers	9	9	9	9	9	9
Number of measurement values without outliers	32	32	32	16	32	32
Mean (mg/L)	142.2	147.8	200.5	150.2	134.4	201.7
Repeatability s.d. Sr	7.1	6.1	9.4	0.9	5.1	15.0
RSDr %	5.0	4.1	4.7	0.6	3.8	7.5
Limit of repeatability r	20.8	17.8	27.5	2.9	14.9	44.0
Relative limit of repeatability r%	14.6%	12.1%	13.7%	1.9%	11.1%	21.8%
Reproducibility s.d. SR	8.2	9.3	15.7	3.6	8.5	18.2
RSDR %	5.8	6.3	7.8	2.4	6.3	9.0
Limit of reproducibility R	23.7	26.9	45.2	10.9	24.6	52.6
Relative limit of reproducibility R%	16.6%	18.2%	22.5%	7.3%	18.3%	26.1%
HORRAT R	0.8	0.8	1.1	0.3	0.8	1.3

The laboratories that summed the peaks of 2-methylbutan-1-ol and 3-methylbutan-1-ol are excluded.

RECUEIL INTERNATIONAL DES METHODES D'ANALYSES – OIV
Analysis of volatile compounds in wines by gas chromatography

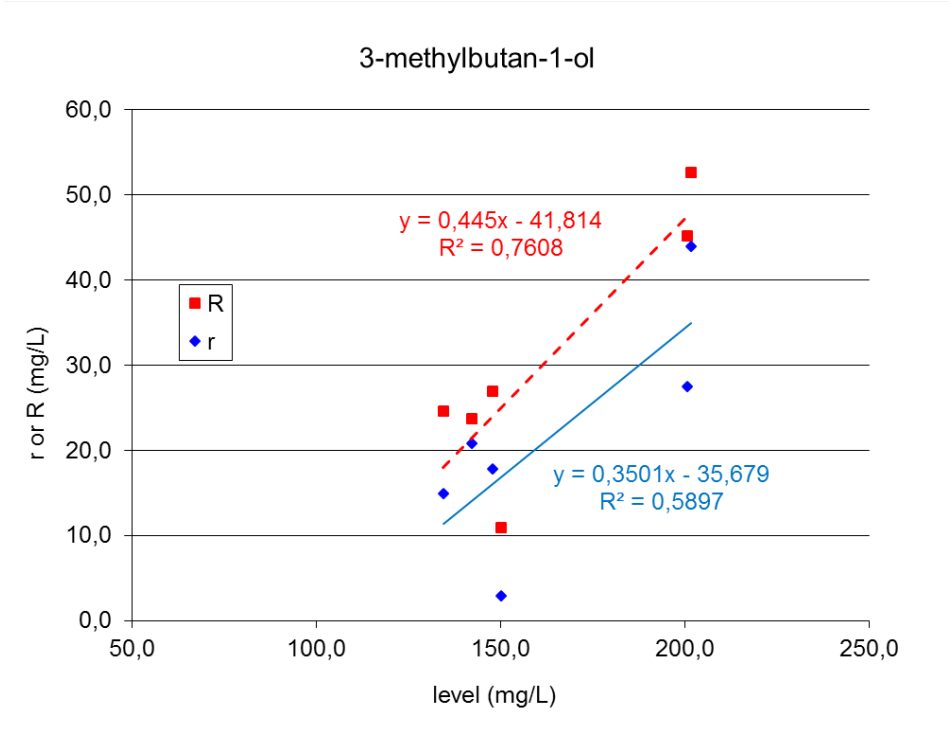

RECUEIL INTERNATIONAL DES METHODES D'ANALYSES – OIV
Analysis of volatile compounds in wines by gas chromatography

**Acetoin - Fidelity
repeatability and reproducibility**

	wine A	wine B	wine C	wine D	wine E	wine F
Method	ISO 5725-2	ISO 5725-2	ISO 5725-2	ISO 5725-2	ISO 5725-2	ISO 5725-2
No. of laboratories that submitted results	13	12	13	13	12	13
No. of laboratories that submitted compliant results	12	9	13	13	10	13
No. of laboratories after elimination of outliers	11	7	13	13	9	13
Number of measurement values without outliers	38	24	46	23	30	46
Mean (mg/L)	5.6	2.1	19.8	53.4	2.4	21.4
Repeatability s.d. Sr	0.7	0.2	1.7	2.6	0.5	1.8
RSDr %	11.5	8.3	8.8	4.9	19.7	8.5
Limit of repeatability r	1.9	0.5	5.0	8.3	1.4	5.2
Relative limit of repeatability r%	33.4%	24.7%	25.2%	15.5%	58.0%	24.3%
Reproducibility s.d. SR	1.3	0.6	3.4	6.5	0.7	3.5
RSDR %	23.1	28.3	17.2	12.2	30.2	16.6
Limit of reproducibility R	3.7	1.7	9.7	19.2	2.1	10.1
Relative limit of reproducibility R%	66.2%	82.8%	48.9%	36.0%	87.3%	47.3%
HORRAT R	1.9	2.0	1.7	1.4	2.2*	1.6

*presumed outlier, not considered for computation of fidelity.

RECUEIL INTERNATIONAL DES METHODES D'ANALYSES – OIV
Analysis of volatile compounds in wines by gas chromatography

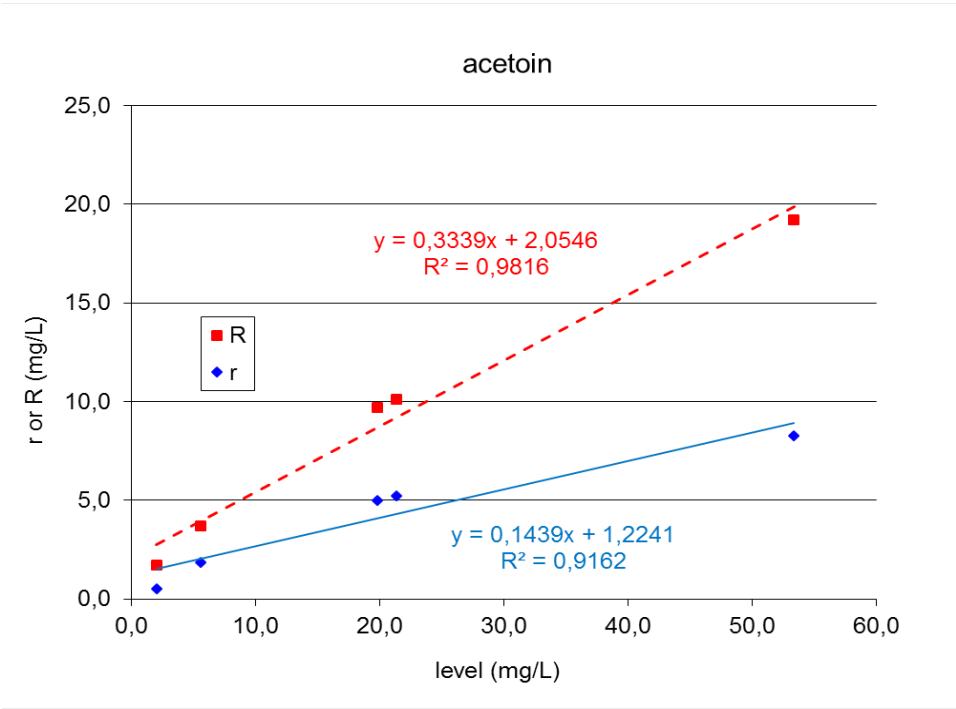

RECUEIL INTERNATIONAL DES METHODES D'ANALYSES – OIV
Analysis of volatile compounds in wines by gas chromatography

Ethyl lactate - Fidelity
repeatability and reproducibility

	wine A	wine B	wine C	wine D	wine E	wine F
Method	ISO 5725-2	ISO 5725-2	ISO 5725-2	ISO 5725-2	ISO 5725-2	ISO 5725-2
No. of laboratories that submitted results	13	13	13	13	13	13
No. of laboratories that submitted compliant results	13	13	13	13	13	13
No. of laboratories after elimination of outliers	13	13	13	13	13	13
Number of measurement values without outliers	46	46	46	23	46	46
Mean (mg/L)	81.5	21.4	149.2	21.8	34.3	118.2
Repeatability s.d. Sr	5.4	1.3	11.9	1.0	2.7	9.1
RSDr %	6.6	6.3	8.0	4.6	7.7	7.7
Limit of repeatability r	15.5	3.9	34.2	3.1	7.6	26.1
Relative limit of repeatability r%	19.0%	18.0%	22.9%	14.2%	22.2%	22.1%
Reproducibility s.d. SR	8.9	4.0	17.7	3.8	5.0	13.0
RSDR %	11.0	18.9	11.8	17.4	14.7	11.0
Limit of reproducibility R	25.5	11.5	50.3	11.1	14.3	37.0
Relative limit of reproducibility R%	31.3%	53.8%	33.7%	51.0%	41.7%	31.3%
HORRAT R	1.3	1.9	1.6	1.7	1.5	1.4

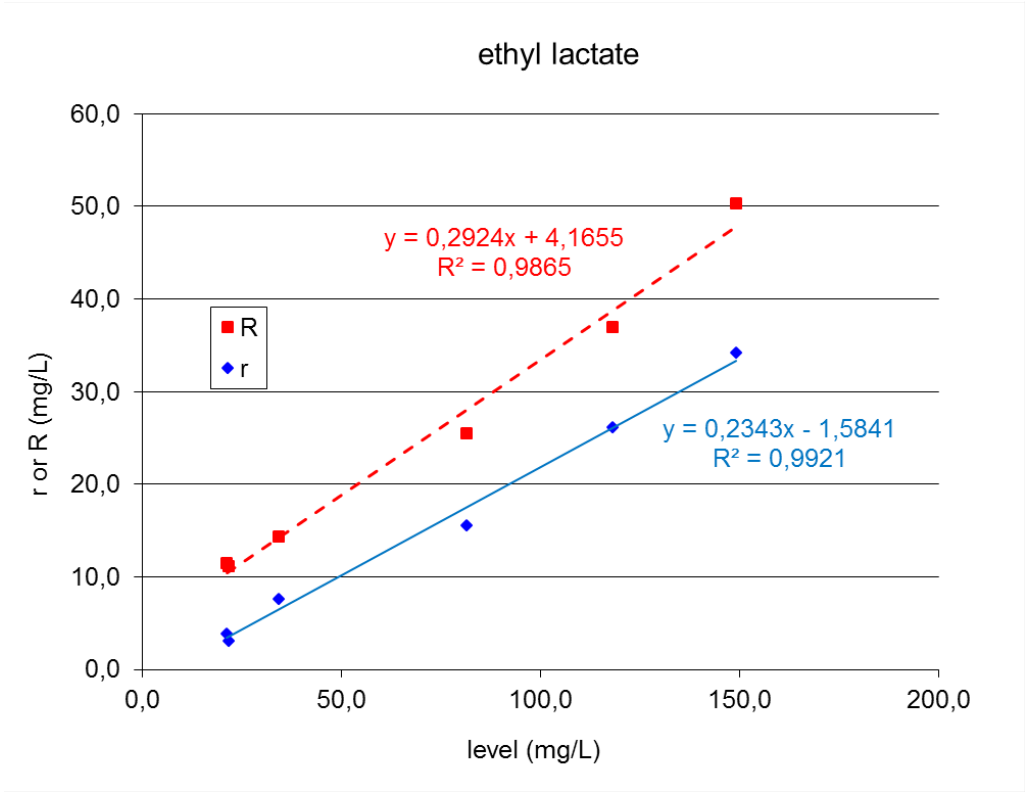

RECUEIL INTERNATIONAL DES METHODES D'ANALYSES – OIV
Analysis of volatile compounds in wines by gas chromatography

Hexan-1-ol - Fidelity
repeatability and reproducibility

	wine A	wine B	wine C	wine D	wine E	wine F
Method	ISO 5725-2	ISO 5725-2	ISO 5725-2	ISO 5725-2	ISO 5725-2	ISO 5725-2
No. of laboratories that submitted results	13	13	13	13	13	13
No. of laboratories that submitted compliant results	11	12	11	13	11	10
No. of laboratories after elimination of outliers	11	12	11	13	10	10
Number of measurement values without outliers	36	38	38	23	34	34
Mean (mg/L)	1.81	1.53	1.99	13.68	1.60	1.22
Repeatability s.d. Sr	0.12	0.16	0.20	0.39	0.10	0.32
RSDr %	6.6	10.6	10.2	2.9	6.6	26.1
Limit of repeatability r	0.35	0.47	0.59	1.23	0.31	0.93
Relative limit of repeatability r%	19.2%	30.7%	29.7%	9.0%	19.2%	76.2%
Reproducibility s.d. SR	0.29	0.30	0.50	0.70	0.21	0.65
RSDR %	15.8	19.8	25.1	5.1	13.1	53.2
Limit of reproducibility R	0.82	0.87	1.43	2.05	0.60	1.87
Relative limit of reproducibility R%	45.4%	56.7%	71.9%	15.0%	37.7%	152.9%
HORRAT R	1.1	1.3	1.7	0.5	0.9	3.4*

*presumed outlier, not considered for computation of fidelity.

RECUEIL INTERNATIONAL DES METHODES D'ANALYSES – OIV
Analysis of volatile compounds in wines by gas chromatography

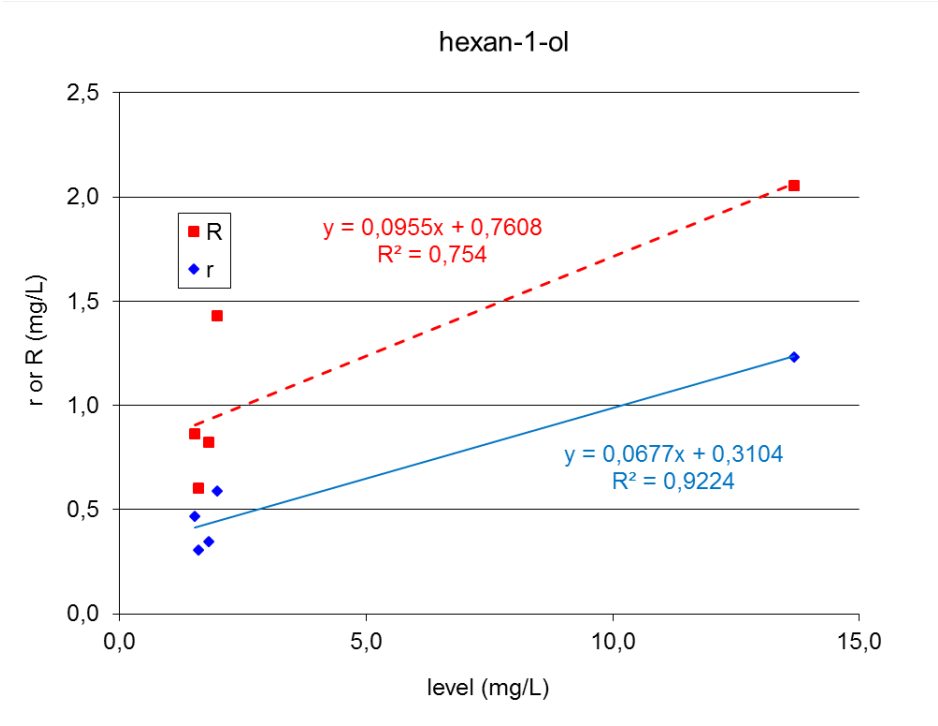

RECUEIL INTERNATIONAL DES METHODES D'ANALYSES – OIV
Analysis of volatile compounds in wines by gas chromatography

**3-ethoxypropanol - Fidelity
repeatability and reproducibility**

	wine A	wine B	wine C	wine D	wine E	wine F
Method	ISO 5725-2	ISO 5725-2	ISO 5725-2	ISO 5725-2	ISO 5725-2	ISO 5725-2
No. of laboratories that submitted results	12	12	12	12	12	11
No. of laboratories that submitted compliant results	7	11	8	11	11	6
No. of laboratories after elimination of outliers	7	11	8	10	11	6
Number of measurement values without outliers	21	37	23	17	30	17
Mean (mg/L)	1.7	3.6	1.4	3.7	3.0	1.1
Repeatability s.d. Sr	1.0	0.4	0.1	0.4	0.4	0.1
RSDr %	62.4	10.9	7.5	11.3	14.4	6.5
Limit of repeatability r	3.2	1.4	0.3	2.1	1.3	0.2
Relative limit of repeatability r%						20.2%
Reproducibility s.d. SDR						0.2
RSDR %						22.6
Limit of reproducibility R						0.7
Relative limit of reproducibility R%						67.7%
HORRAT R						1.4

*presumed outlier, not considered for computation of fidelity.

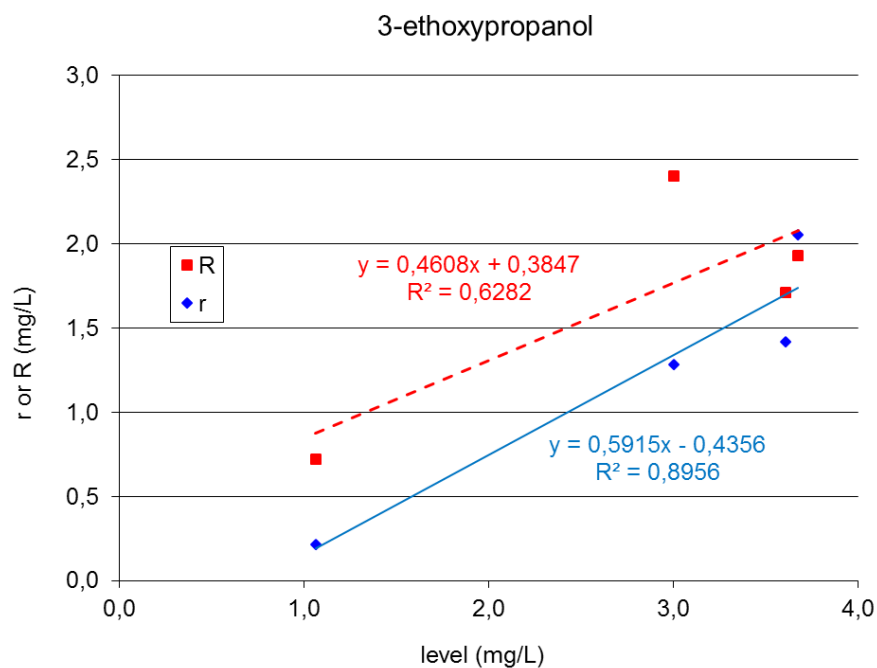

RECUEIL INTERNATIONAL DES METHODES D'ANALYSES – OIV
Analysis of volatile compounds in wines by gas chromatography

**Ethyl octanoate - Fidelity
repeatability and reproducibility**

	wine A	wine B	wine C	wine D	wine E	wine F
Method	ISO 5725-2	ISO 5725-2	ISO 5725-2	ISO 5725-2	ISO 5725-2	ISO 5725-2
No. of laboratories that submitted results	12	12	12	12	12	12
No. of laboratories that submitted compliant results	7	9	5	9	9	4
No. of laboratories after elimination of outliers	7	9	5	8	9	4
Number of measurement values without outliers	19	30	10	13	30	10
Mean (mg/L)	0.8	1.1	0.7	1.0	1.0	0.8
Repeatability s.d. Sr	0.03	0.2	0.3	0.1	0.2	0.4
RSDr %	4.1	20.6	47.0	10.3	24.0	49.5
Limit of repeatability r	0.1	0.7	1.2	0.3	0.7	1.4
Relative limit of repeatability r%	12.5%	60.7%	171.1%	34.4%	70.6%	171.3%
Reproducibility s.d. SR	0.2	0.3	0.6	0.1	0.3	0.8
RSDR %	29.9	23.5	91.4	8.2	31.8	90.3
Limit of reproducibility R	0.7	0.8	2.0	0.3	0.9	2.4
Relative limit of reproducibility R%	88.8%	67.9%	292.8%	25.3%	92.0%	288.8%
HORRAT R	1.8	1.5	5.4*	0.5	2.0	5.5*

*presumed outlier, not considered for computation of fidelity.

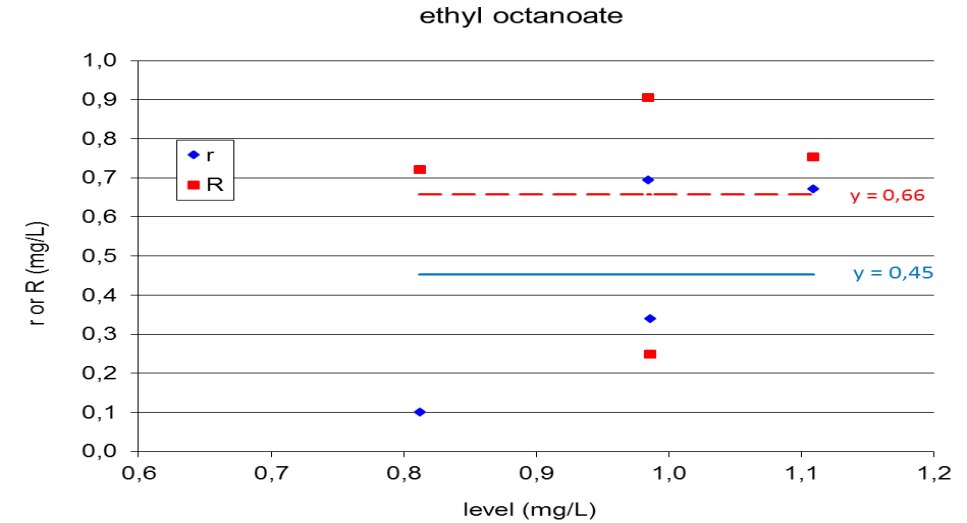

RECUEIL INTERNATIONAL DES METHODES D'ANALYSES – OIV
Analysis of volatile compounds in wines by gas chromatography

Butyrolactone - Fidelity
repeatability and reproducibility

	wine A	wine B	wine C	wine D	wine E	wine F
Method	ISO 5725-2	ISO 5725-2	ISO 5725-2	ISO 5725-2	ISO 5725-2	ISO 5725-2
No. of laboratories that submitted results	10	10	10	10	10	10
No. of laboratories that submitted compliant results	10	10	10	10	10	10
No. of laboratories after elimination of outliers	8	8	7	10	9	8
Number of measurement values without outliers	26	28	24	17	30	28
Mean (mg/L)	12.8	10.9	18.8	11.3	8.2	19.1
Repeatability s.d. Sr	1.4	1.2	1.6	1.2	2.9	2.1
RSDr %	11.1	10.6	8.6	10.3	34.9	11.1
Limit of repeatability r	4.2	3.4	4.8	3.9	8.5	6.3
Relative limit of repeatability r%	33.1%	31.2%	25.5%	34.3%	102.7%	32.8%
Reproducibility s.d. SR	2.6	2.0	2.6	3.9	2.9	2.8
RSDR %	19.9	18.2	13.9	34.4	35.6	14.5
Limit of reproducibility R	7.4	5.7	7.6	11.6	8.5	8.0
Relative limit of reproducibility R%	57.9%	52.7%	40.7%	103.1%	102.9%	42.1%
HORRAT R	1.8	1.6	1.4	3.1*	3.1*	1.4

*presumed outlier, not considered for computation of fidelity.

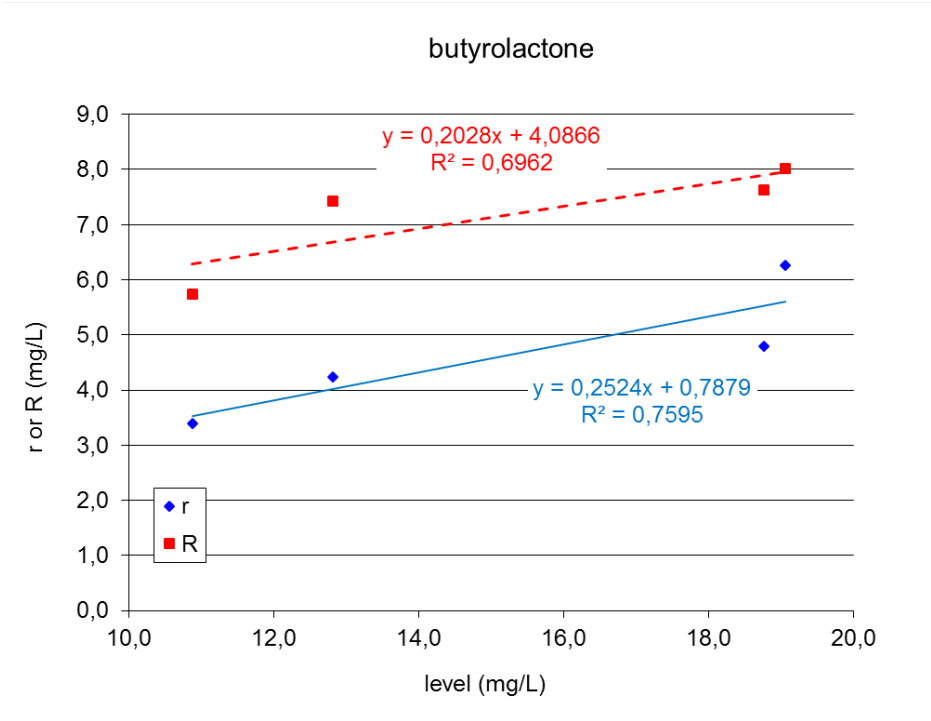

RECUEIL INTERNATIONAL DES METHODES D'ANALYSES – OIV
Analysis of volatile compounds in wines by gas chromatography

**Diethyl succinate - Fidelity
repeatability and reproducibility**

	wine A	wine B	wine C	wine D	wine E	wine F
Method	ISO 5725-2	ISO 5725-2	ISO 5725-2	ISO 5725-2	ISO 5725-2	ISO 5725-2
No. of laboratories that submitted results	13	13	13	13	13	13
No. of laboratories that submitted compliant results	13	10	13	10	12	13
No. of laboratories after elimination of outliers	11	10	13	10	12	12
Number of measurement values without outliers	40	34	46	17	35	42
Mean (mg/L)	6.5	3.3	15.9	4.0	3.7	10.7
Repeatability s.d. Sr	0.7	0.4	1.8	1.5	0.6	1.9
RSDr %	11.0	11.2	11.2	37.8	16.1	17.4
Limit of repeatability r	2.1	1.1	5.1	5.0	1.7	5.4
Relative limit of repeatability r%	31.7%	32.6%	32.1%	126.4%	47.1%	50.2%
Reproducibility s.d. SR	1.3	1.5	3.2	1.9	1.3	2.4
RSDR %	20.5	44.9	20.0	48.6	35.4	22.0
Limit of reproducibility R	3.8	4.3	9.0	5.8	3.7	6.7
Relative limit of reproducibility R%	58.6%	129.2%	56.9%	145.6%	101.7%	63.0%
HORRAT R	1.7	3.4*	1.9	3.7*	2.7*	2.0

*presumed outlier, not considered for computation of fidelity.

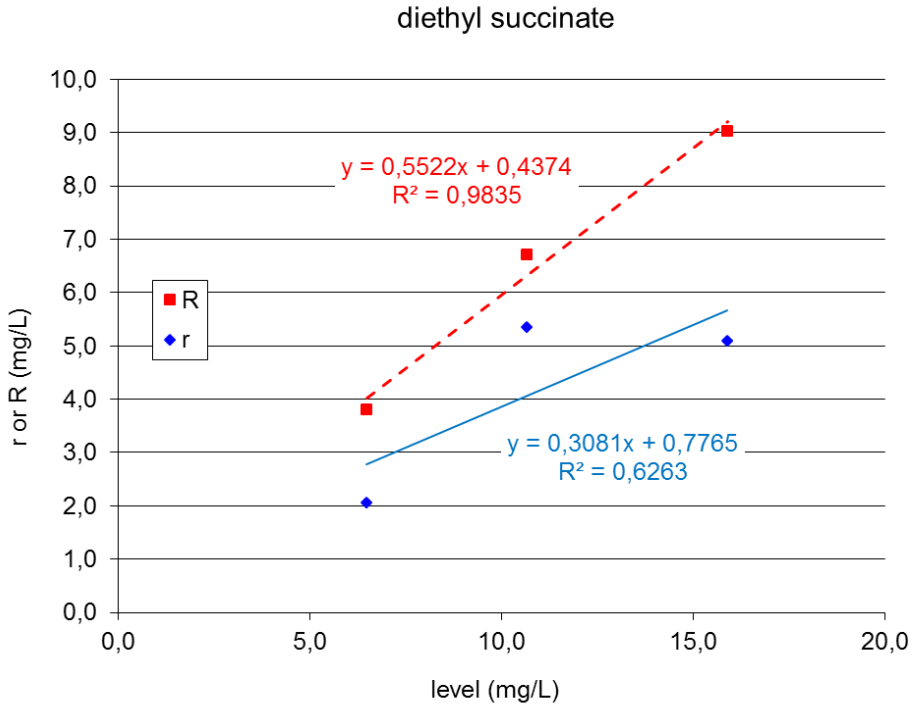

RECUEIL INTERNATIONAL DES METHODES D'ANALYSES – OIV
Analysis of volatile compounds in wines by gas chromatography

**2-phenylethanol - Fidelity
repeatability and reproducibility**

	wine A	wine B	wine C	wine D	wine E	wine F
Method	ISO 5725-2	ISO 5725-2	ISO 5725-2	ISO 5725-2	ISO 5725-2	ISO 5725-2
No. of laboratories that submitted results	13	13	13	13	13	13
No. of laboratories that submitted compliant results	13	13	13	13	13	13
No. of laboratories after elimination of outliers	12	12	12	12	12	13
Number of measurement values without outliers	42	42	42	21	42	46
Mean (mg/L)	19.4	18.8	47.0	18.7	15.6	53.1
Repeatability s.d. Sr	1.4	2.4	4.5	1.0	1.4	4.2
RSDr %	7.4	13.0	9.6	5.3	9.1	7.8
Limit of repeatability r	4.2	7.0	13.0	3.2	4.1	11.9
Relative limit of repeatability r%	21.5%	37.4%	27.7%	17.1%	26.3%	22.5%
Reproducibility s.d. SR	2.9	3.0	6.8	1.4	1.7	8.8
RSDR %	15.1	16.2	14.5	7.6	11.0	16.6
Limit of reproducibility R	8.4	8.7	19.5	4.2	4.9	25.2
Relative limit of reproducibility R%	43.1%	46.2%	41.4%	22.4%	31.5%	47.4%
HORRAT R	1.5	1.6	1.6	0.7	1.0	1.9

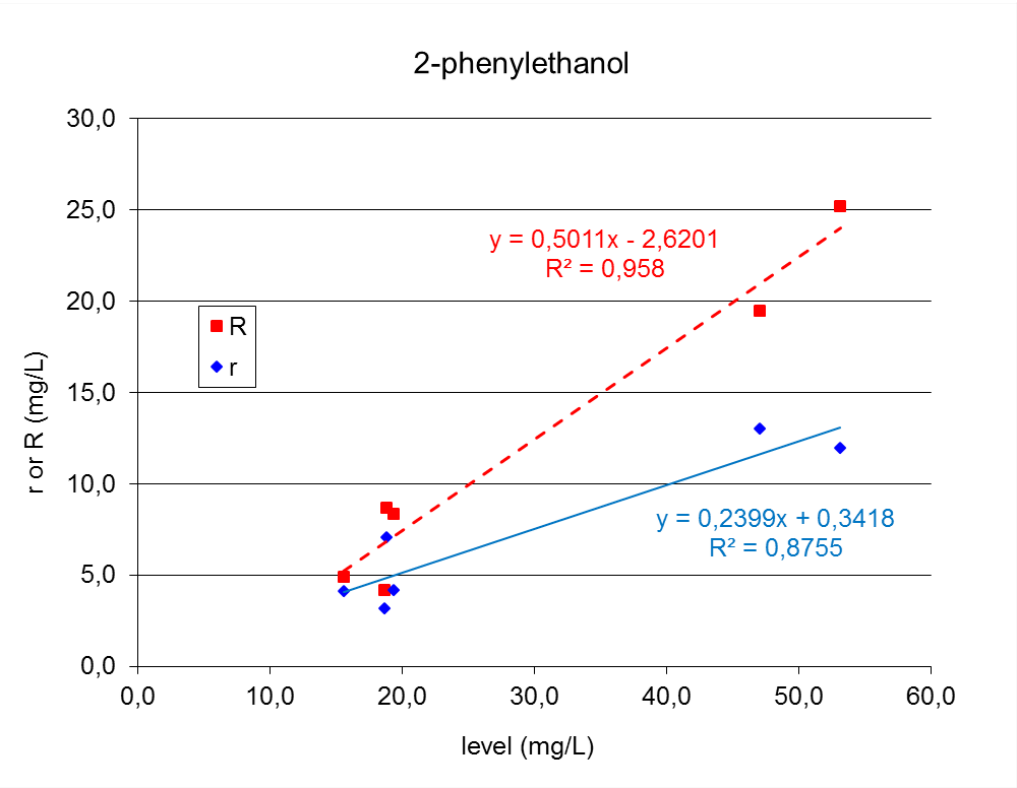

RECUEIL INTERNATIONAL DES METHODES D'ANALYSES – OIV
Analysis of volatile compounds in wines by gas chromatography

**Ethyl acetate - Fidelity
repeatability and reproducibility**

	wine A	wine B	wine C	wine D	wine E	wine F
Method	ISO 5725-2	ISO 5725-2	ISO 5725-2	ISO 5725-2	ISO 5725-2	ISO 5725-2
No. of laboratories that submitted results	13	13	13	13	13	13
No. of laboratories that submitted compliant results	13	13	13	13	13	13
No. of laboratories after elimination of outliers	12	12	12	13	12	13
Number of measurement values without outliers	42	42	42	23	42	46
Mean (mg/L)	26.4	60.5	55.5	60.6	25.5	68.4
Repeatability s.d. Sr	1.6	2.6	2.4	1.4	1.1	6.0
RSDr %	5.9	4.2	4.3	2.4	4.3	8.8
Limit of repeatability r	4.5	7.4	6.9	4.5	3.2	17.3
Relative limit of repeatability r%	16.9%	12.2%	12.3%	7.4%	12.5%	25.3%
Reproducibility s.d. SR	2.8	4.7	4.4	8.8	2.2	7.3
RSDR %	10.7	7.7	8.0	14.5	8.5	10.6
Limit of reproducibility R	8.1	13.4	12.6	25.8	6.2	20.7
Relative limit of reproducibility R%	30.5%	22.1%	22.7%	42.6%	24.2%	30.3%
HORRAT R	1.1	0.9	0.9	1.7	0.9	1.2

**Method of determination of 1,2-propanediol
and 2,3-butanediol**
(OIV-OENO 589-2017)

1. INTRODUCTION

Measurable quantities of 1,2-propanediol and 2,3-butanediol are formed following fermentation processes. These compounds are practically absent in unfermented musts, yet found within certain limits in wines.

2. PRINCIPLE

The analytes and the internal standard are extracted through the use of ethyl ether. Their transfer into the organic phase is facilitated by the increase in the ionic strength of the initial wine or must matrix. A large quantity of K_2CO_3 is added to the samples ('salting out') for this purpose. The extracts are analysed directly via GC-MS on a polar column. The detection is conducted according to the retention time and the mass spectrometer.

3. SCOPE OF APPLICATION

The method is suitable for determining 1,2-propanediol and 2,3-butanediol in musts and wines whose sugar content is greater than 20 g/L and whose analyte concentrations are between 1 mg/L and 500 mg/L.

4. ABBREVIATIONS

C	Concentration
PG	1,2-Propanediol
GC-MS	Gas Chromatograph-Mass Spectrometer
H ₂	Hydrogen
IS	Internal standard 1,3-butanediol
m/z	Mass/charge ratio
RF	Response factor
ML	Matrix calibration level

SS	Stock solution
CS	Calibration solution
RT	Retention time
CS	Calibration solutions for gas chromatography
BG	2,3-Butanediol
S	Wine with a sugar content > 20 g/L
M	Must

5. REAGENTS

- 5.1. K_2CO_3 (CAS no. 584-08-7)
- 5.2. Ethyl ether (CAS no. 60-29-7)
- 5.3. Absolute ethanol (CAS no. 64-17-5)
- 5.4. Fructose (CAS no. 57-48-7)
- 5.5. Glucose (CAS no. 50-99-7)
- 5.6. Glycerol (CAS no. 56-81-5)
- 5.7. 1,2-Propanediol, purity > 99% (CAS no. 57-55-6)
- 5.8. 2,3-Butanediol, purity > 99%, mix of (R,R)- and (R,S)-isomers (CAS no. 513-85-9). Estimate the relative quantity of the (R,R) and (R,S) forms as follows:
 - 5.8.1. prepare a 100 mg/L solution following the instructions in points 7.2.1 and 7.3, diluting the mix of 2,3-butanediol isomers (5.8) in water (5.10) instead of in the matrix model solution;
 - 5.8.2. inject into the GC, under the conditions described in point 7.6, and calculate the percentage of (R,R) and (R,S) forms from the percentage of the areas of the two peaks;
 - 5.8.3. take into consideration the relative quantity of the two forms to calculate the concentration of the calibration solutions, $C_{CS,i}$, used in paragraph 8.2.1 for the calculation of the RF_i relating to the (R,R) and (R,S) forms.
- 5.9. 1,3-Butanediol, purity > 99%, anhydrous (or dehydrated with sodium sulphate for 24 hours) (CAS no. 107-88-0)
- 5.10. Purified water for laboratory use, certified to the EN ISO 3696 standard
- 5.11. Nitrogen

6. APPARATUS

- 6.1. Everyday laboratory apparatus such as class-A 1000-mL, 200-mL and 100-mL flasks
- 6.2. Analytical scale with an accuracy of $\pm 0,0001$ g

6.3. Laboratory centrifuge (at least 4000 rpm or 2000 xg)

Note 1. The unit 'xg' refers to the acceleration experienced by particles in a centrifuge, while 'rpm' represents the number of revolutions the rotor of the centrifuge makes per minute. There is a relationship between these units of measurement:

$xg = 1.1178 \cdot 10^{-3} \cdot n^2 \cdot r$. In the laboratory that developed this method, $r = 0.115$ m.

6.4. Chromatograph coupled to a mass spectrometer and split-splitless injector

6.5. Precision micropipettes and Pasteur pipettes

6.6. 30-mL centrifuge tubes resistant to ether and provided with stoppers

6.7. Thermostatically-controlled water bath

6.8. Vertical vortex mixer

7. PROCEDURE

7.1. Preparation of the model solutions that simulate the matrix

To obtain a better response to the GC-MS during quantification, different solutions should be prepared that simulate the matrix of the sample in question as much as possible, given that the response to the analysis of glycols varies according to the matrix in which they were diluted.

Table 1: Preparation of the model solutions in 1000-mL calibrated flasks.

	Model solution	
	M	S
Fructose	100 g/L	50 g/L
Glucose	100 g/L	50 g/L
Glycerol	1 g/L	4 g/L
Absolute ethanol	1% v/v	5% v/v

7.2. Preparation of reference solutions

7.2.1. SS: PG and BG stock solutions

With an accuracy of 0.1 mg, weigh about 0.10 g of 1,2-propanediol (PG) and about 0.10 g of 2,3-butanediol (BG) into a 10-mL calibrated flask and fill up to the calibration mark with water (5.10). Make a note of the weights. Hermetically seal the flask and mix. The concentration is

approximately 10 mg/mL in the PG solution and 10 mg/mL in the BG solution.

If the quantities of PG and BG differ by 0.1 g, calculate the exact concentrations based on the weights noted.

7.2.2. IS: IS stock solution

With an accuracy of 0.1 mg, weigh about 0.10 g of 1,3-Butanediol (IS) into a 10-mL calibrated flask and fill up to the calibration mark with water (5.10). Make a note of the weight. Hermetically seal the flask and mix. The concentration of this solution is 10 mg/mL.

If the quantity of IS differs by 0.1 g, calculate the exact concentration based on the weights noted.

7.3. Preparation of the calibration matrix solution

The calibration solutions are prepared as follows, by diluting the SS solution into a model solution whose composition is as close as possible to that of the sample for analysis (for sweet wine, S model solution; for must, M model solution):

Table.2: Preparation of calibration solutions (CS) in 100-mL calibrated flasks:

	CS-M	CS-S
SS Solution	1 mL	1 mL
To reach a final volume of 100 mL, make up to volume with:	M model solution	S model solution

Every CS calibration solution contains the selected matrix and the concentration of PG and BG is 100 mg/L. The internal standard is added before the extraction as described in paragraph 7.5.

7.4. Preparation of samples

If the analyte concentration in the sample is greater than the maximum concentration provided within the scope of application, dilute the sample with the model solution (7.1).

Stir the sample before taking the 10 mL to be extracted.

In the case of musts or cloudy wines, sample the clear wine after filtration.

In the case of sparkling or semi-sparkling wines, carry out degassing as described in the OIV method 'Total Acidity' (OIV-MA-AS313-01, point 5.1).

Proceed with all of the preparation and carry out the tests in duplicate.

7.5. Extraction

7.5.1. *Adding the internal standard (IS) to the sample*

Prepare a solution containing 5 mL of IS solution (7.2.2) in a 100-mL flask and fill up to the calibration mark with the sample to be analysed, then shake well.

This solution contains 500 mg/L of IS.

7.5.2. *Musts and wines with a sugar content > 20 g/L*

7.5.2.1. *Addition of K₂CO₃*

Pour 10 mL of the solution just prepared, composed of the sample to be analysed and the IS solution, into the centrifuge test tube (6.6), then add 10 g of K₂CO₃ (5.1) and wait for it to cool. To speed up cooling you may use a thermostatically-controlled water bath at 20 °C (6.7).

7.5.2.2. *Extraction with ether*

Once cooled, add 10 mL of ethyl ether (5.2) and shake the whole mixture with a vertical vortex agitator, then put it in the centrifuge (6.3) at about 3500 rpm (or 1500 xg) for 10 minutes.

7.5.3. *Purification for GC/MS analysis*

The supernatant liquid is collected with a Pasteur pipette, transferred into a suitable flask and the solvent evaporated under a flow of nitrogen. The residue is recovered with about 1 mL of ethyl ether and placed in a tightly sealed GC vial ready for GC/MS analysis.

7.5.4. *Extraction of the CS calibration solutions*

This procedure must also be carried out for the chosen CS calibration solution (7.3). The CS solutions must be considered as samples to all intents and purposes, and must thus be treated in the same way as the sample starting from the moment the IS is added (7.5.1).

7.6. GC-MS analysis

By way of example, the specific parameters of the GC-MS analysis are given below. Alternative systems may be used, if they give adequate chromatographic performances and make it possible to separate the chromatographic peaks with a precision of greater than 2.

7.6.1. GC typical conditions

Column: 60 m x 0.25 mm x 0.25 µm DB-WAX

Carrier gas: He

Carrier gas flow: 1.0 mL/min

Injector temperature: 250 °C

Injection volume: 1 µL

Ionising current: 70 eV

Temperature settings:

	Increase (°C/min)	Temperature (°C)	Time (min)
Start		50	8.00
Ramp 1	4.0	220	
Ramp 2		220	40

7.6.2. Specific MS conditions

Source: 230 °C

MS detector: 150 °C scan, 35.00 – 350.00 amu.

Start time: 10 min

Acquisition time for each mass is 250 µs

Acquisition mode: Full Scan

8. EVALUATION

8.1. Identification

Identification is performed by comparing the retention time of the calibration solutions provided for this purpose and the mass spectrum found in the library associated with the GC-MS.

8.2. Calculations

For quantification, $m/z = 45$ is used for the IS, and also the PG and two forms of BG.

8.2.1. Determination of response factors

Quantification is carried out based on the response factor RF obtained by analysing the reference solution:

$$RF_i = \frac{A_{IS}/C_{IS}}{A_{CS,i}/C_{CS,i}}$$

where:

A_{IS} is the peak area of the internal standard and C_{IS} is its concentration;

$A_{CS,i}$ is the peak area of the PG or each of the isomeric forms of BG in the calibration solution and $C_{CS,i}$ is its concentration.

8.2.2. Calculation of the concentrations in the samples

Once the response factor RF has been calculated the calculation of the concentration of PG and each of the isomeric forms of BG in the samples can be performed, according to the following formula:

$$C_i = RF_i \times C_{CS} \times A_i/A_{is}$$

where:

A_i is the peak area of the PG or the BG in the sample and C_i is its concentration.

8.3. Expression of the results

The results are expressed in mg/L to the nearest whole number.

Express 2,3-butanediol as the sum of (R,R)-2,3-butanediol and (R,S)-2,3-butanediol.

9. BIBLIOGRAPHY

Carsten Fauhl, Reiner Wittkowski, Janice Lofthouse, Simon Hird, Paul Brereton, Giuseppe Versini, Michele Lees and Claude Guillou, 'Gas Chromatographic/Mass Spectrometric Determination of 3-Methoxy-1,2-Propanediol and Cyclic Diglycerols, By-Products of Technical Glycerol, in Wine: Interlaboratory Study', *JOURNAL OF AOAC INTERNATIONAL*, VOL. 87, NO. 5, 2004.

Di Stefano, R., García Moruno, E. and Borsa, D., 'Proposta di un metodo di preparazione del campione per la determinazione dei glicoli dei vini', *VINI D'ITALIA*, 4, 1992, pp. 61-64.

García Moruno, E. and Di Stefano, R., 'La determinazione del glicerolo, del 2,3-butanediolo e dei glicoli nei vini', *VINI D'ITALIA*, 5, 1989, pp. 41-46.

Di Stefano, R., Borsa, D. and García Moruno, E., 'Glicoli naturalmente presenti nei vini', *VINI D'ITALIA*, 5, 1988, pp. 39-44.

ANNEX 1

METHOD PERFORMANCE

1. Linearity

Verification of the linearity of the response for a 200 g/L sugar solution (100 g/L of glucose and 100 g/L of fructose). Each analyte was added at concentrations of 10, 100 and 500 mg/L, while the IS was added at a concentration of around 100 mg/L. The measurements were repeated three times.

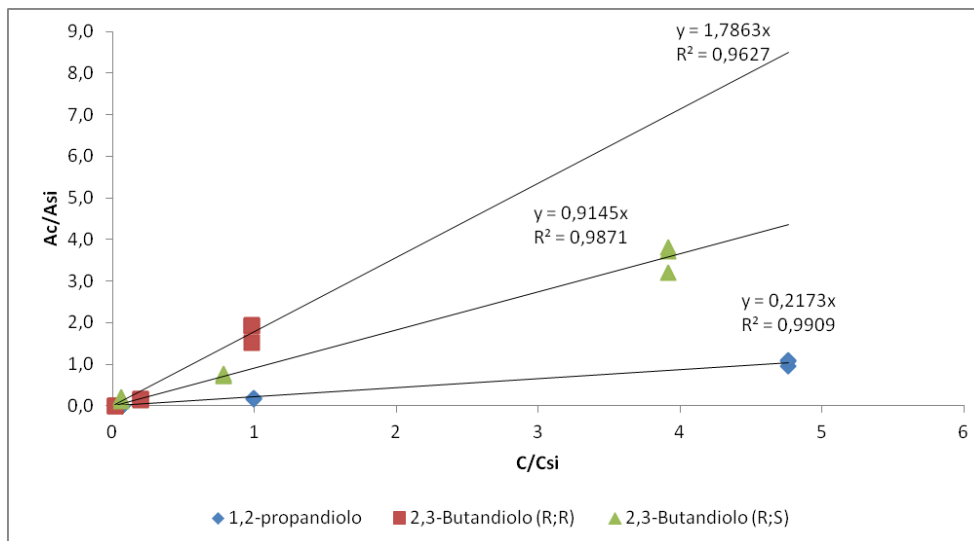

The mean response factors are:

1,2-Propanediol	$RF = (C/C_{IS})/(A/A_{IS}) = 1/0.2173 = 4.60$
(R,R)-2,3-Butanediol	$RF = (C/C_{IS})/(A/A_{IS}) = 1/1.7863 = 0.56$
(R,S)-2,3-Butanediol	$RF = (C/C_{IS})/(A/A_{IS}) = 1/0.9145 = 1.09$

2. Repeatability

The repeatability was evaluated for two must samples.

One was analysed as such (Must N°1) and the other was obtained by adding 100 mg/L of SS stock solution to it (Must N°2).

The following table makes reference to 10 repeated analyses, and the repeatability (r) is calculated according to the formula $r = 2.8 * Sr$. (Sr = repeatability standard deviation, RSDr = relative standard deviation of repeatability).

Compound	Must N°1				Must N°2			
	Mea n (mg/ L)	Sr (mg/ L)	RS Dr (%)	r (mg/ L)	Mea n (mg/ L)	Sr (mg/ L)	RS Dr (%)	r (mg/L)
1,2-Propanediol	1.5	0.5	36	1.5	107	9	9	30
(R,R)-2,3- Butanediol	3.2	1.6	52	4.6	30	3	9	9.0
(R,S)-2,3- Butanediol	5.4	1.7	33	4.9	104	11	10	34

Evaluation of the precision of the limit of repeatability according to the Horwitz equation and Horrat parameter (r):

**RECUEIL INTERNATIONAL DES METHODES D'ANALYSES – OIV
Method of determination of 1,2-propanediol and 2,3-butanediol**

Must no. 1

	Mean (mg/L)	C·10 ⁶ (m/m)	PRSD (R)	R Horwitz	Horrat (r)	r min H	r max H
1,2- Propanedio l	1.5	1.5	15	0.6	2.40	0.2	0.8
(R,R)-2,3- Butanediol	3.2	3.2	13	1.2	3.87	0.3	1.6
(R,S)-2,3- Butanediol	5.4	5.4	12	1.9	2.64	0.5	2.5

The limit of repeatability 'r' is not contained within the validation range specified by the Horwitz equation ($r_{\min H} < r < r_{\max H}$) due to the greater volatility of low-concentration measurements, close to the limit of quantification established in paragraph 5 of Annex 1.

Must no.2

	Mean (mg/L)	C·10 ⁵ (m/m)	PRSD (R)	R Horwitz	Horrat (r)	r min H	r max H
1,2- Propanedio l	107	11	7.9	24	1.09	5.9	31.8
(R,R)-2,3- Butanediol	30	3	9.5	8	0.98	2.0	10.7
(R,S)-2,3- Butanediol	104	10	7.9	23	1.29	5.7	30.8

The limit of repeatability 'r' is not contained within the validation range specified by the Horwitz equation ($r_{\min H} < r < r_{\max H}$).

3. Recovery rate

The recovery rate was evaluated for must N°2 before and after addition of the SS stock solution, as described in paragraph 7.3 of the method.

Compound	C. in the	C. added	Theoretica l C.	Measure d C.	Reco very
----------	--------------	-------------	--------------------	-----------------	--------------

RECUEIL INTERNATIONAL DES METHODES D'ANALYSES – OIV
Method of determination of 1,2-propanediol and 2,3-butanediol

	must (mg/ L)	(mg/ L)	(mg/L)	(mg/L)	rate (%)
1,2-Propanediol	0.7	99.5	100.2	107.5	107
(R,R)-2,3-Butanediol	12.6	21.7	34.3	29.9	87
(R,S)-2,3-Butanediol	11.4	86.8	98.2	103.7	106
<i>(R,R)- + (R,S)-2,3-Butanediol</i>	<i>24.0</i>	<i>108.5</i>	<i>132.5</i>	<i>133.6</i>	<i>101</i>

The recovery rate is satisfactory for 1,2-propanediol and for 2,3-butanediol evaluated overall as the sum of both forms.

4. Effect of the sugar matrix on the response factors

The RFs obtained for the equimolar glucose and fructose solutions with total sugar concentrations of 200 g/L and 2 g/L were compared.

	1,2-Propanediol		(R,R)-2,3-Butanediol		(R,S)-2,3-Butanediol	
Sugars	200 g/L	2 g/L	200 g/L	2 g/L	200 g/L	2 g/L
RF	4.60	5.90	0.55	0.56	1.08	1.09
$ \Delta\text{RF} \%$	22.0 %		1.8 %		0.9 %	

The effect of the matrix on 1,2-Propanediol is highly marked, while it is negligible for both forms of 2,3-Butanediol.

5. Limit of detection and limit of quantification

The limit of detection (LOD) and limit of quantification (LOQ) depend on specific analytical-chemical measurement conditions and should be determined by all those who use the method.

The limit of detection (LOD) and limit of quantification (LOQ) were evaluated using the above-mentioned equipment and conditions (point 8) and by following the instructions of Resolution OENO 7-2000 (OIV-MA-AS1-10) 'Estimation of the detection and quantification limits of a method of analysis' as described in paragraph 4.2 concerning the "Graph" Approach.

	1,2-Propanediol	(R,R)-2,3-Butanediol	(R,S)-2,3-Butanediol
LOD (mg/L)	0.2	0.2	0.2

RECUEIL INTERNATIONAL DES METHODES D'ANALYSES – OIV
Method of determination of 1,2-propanediol and 2,3-butanediol

LOQ (mg/L)	0.6	0.7	0.8
---------------	-----	-----	-----

Annex 2

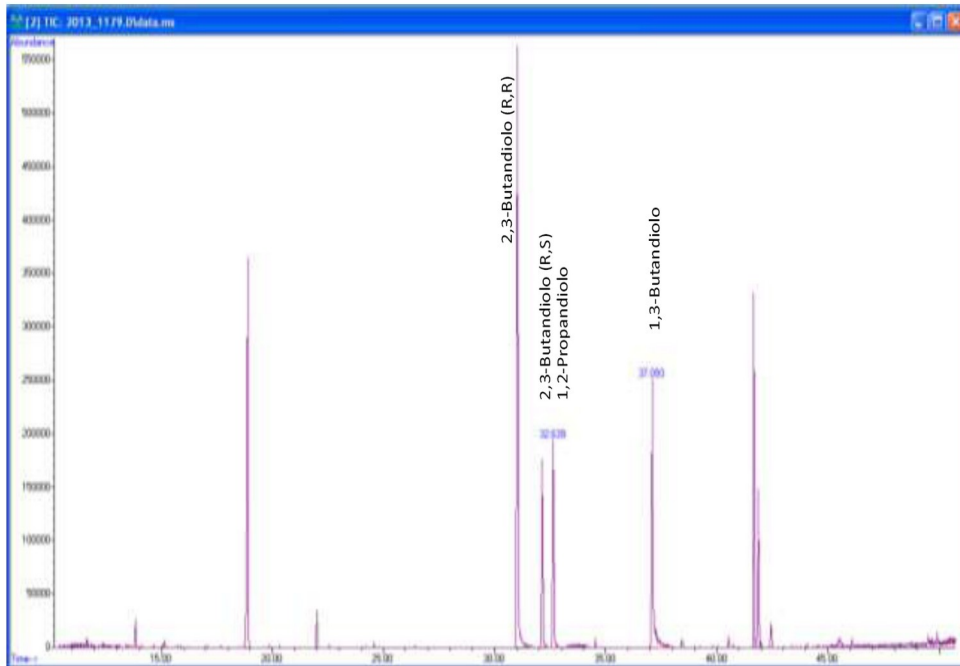

FIG. 1 Chromatogram of a wine.

Detection of chitinase and thaumatin-like
proteins in white wines
OIV-OENO 529/2017

1. Introduction

For the detection of unstable proteins and risks of protein *casé* in white wines, many tests are heat- or precipitation-based, the latter using a chemical agent. These tests give very different, unreliable and even contradictory results. This immunological method of semi-quantitative immunoprinting makes it possible to determine the presence or absence of unstable proteins in wines. Therefore, chitinase and thaumatin-like proteins can be detected from a total concentration of as low as 1 mg/L in wines. This value is taken from the comparison of results with the SDS electrophoresis method described in the *Compendium of Methods of Analysis* (OIV-MAA-AS315-12), for which the limit of detection is 1 mg/L.

2. Scope of application

This immunological method of immunoprinting applies to white wines.

3. Principle

The immunological method of immunoprinting is conducted in 3 steps:

- 3.1 Application of the wine sample to a nitrocellulose membrane
- 3.2 Detection of unstable proteins
- 3.3 Revelation of the presence of unstable proteins

The intensity of the coloured spots observed on the membrane is proportional to the quantity of unstable proteins and to the risk of protein *casé* in wine.

4. Reagents and products

- 4.1 List of reagents and products

RECUEIL INTERNATIONAL DES METHODES D'ANALYSES – OIV
Detection of chitinase and thaumatin-like
proteins in white wines

Unless otherwise indicated, use the products as marketed.

- 4.1.1 Ultra-pure water: resistivity $\geq 18 \text{ M}\Omega\cdot\text{cm}$ at 25 °C
- 4.1.2 A wine very rich in proteins and a wine containing no proteins following treatment with bentonite. These wines are used for the positive and negative controls respectively: verification and quantification of proteins present in these wines may be conducted using SDS-PAGE electrophoresis (Method OIV-MA-AS315-12)
- 4.1.3 Rabbit polyclonal antibodies directed against unstable proteins in wine: see the protocol in the Annex
- 4.1.4 Goat anti-rabbit IgA polyclonal antibodies conjugated to horseradish peroxidase (hereinafter referred to as: goat anti-rabbit-HRP antibodies)
- 4.1.5 Anhydrous sodium chloride (NaCl): CAS No. 7647-14-5
- 4.1.6 Anhydrous Tris-HCl: CAS No. 1185-53-1
- 4.1.7 Concentrated HCl in solution; purity $\geq 36.5\%$: CAS No. 7647-01-0
- 4.1.8 Tween 20: CAS No. 9005-64-5
- 4.1.9 Lyophilised Bovine Serum Albumin (BSA) powder; purity $\geq 96\%$: CAS No. 9048-46-8
- 4.1.10 4-Chloro-1-naphthol; purity $\geq 99\%$: CAS No. 604-44-4
- 4.1.11 Methanol; purity $\geq 99.8\%$: CAS No. 67-56-1
- 4.1.12 Hydrogen peroxide in solution (H_2O_2); purity $\geq 30\%$: CAS No. 7722-84-1

4.2 Preparation of working solutions

All of the solutions may be stored for 1 year at 4 °C.

4.2.1 TBS buffer (tris-buffered saline)

Dissolve 29.22 g of sodium chloride (4.1.5) and 2.42 g of anhydrous Tris-HCl (4.1.6) in 1 litre of ultra-pure water (4.1.1). Adjust the pH to 7.5 using a concentrated HCl solution (4.1.7).

4.2.2 TBS-Tween 20 buffer

Add 0.05% of Tween 20 (4.1.8) to the TBS buffer (4.2.1).

RECUEIL INTERNATIONAL DES METHODES D'ANALYSES – OIV
Detection of chitinase and thaumatin-like
proteins in white wines

4.2.3 Blocking solution

Add 4% of BSA (4.1.9) to the TBS buffer (4.2.1).

4.2.4 Polyclonal antibody solution (available on the market or according to the protocol described in the Annex)

4.2.4.1 Dilute the unstable anti-protein polyclonal antibodies (primaries) according to commercial recommendations or to their concentrations in the TBS buffer (4.2.1).

4.2.4.2 Dilute the goat anti-rabbit-HRP polyclonal antibodies (secondaries) according to commercial recommendations or to their concentrations in the TBS buffer (4.2.1).

4.2.5 Solutions for revelation of unstable proteins

4.2.5.1 Dissolve 30 mg of 4-chloro-1-naphthol (4.1.10) in 10 mL of methanol (4.1.11). Place this solution in the dark at -20 °C until needed.

4.2.5.2 Add 30 µL of 30% H₂O₂ (4.1.12) to 50 mL of TBS (4.2.1) just before use.

5. Materials

5.1 List of materials for the immunoprinting reaction:

- 5.1.1 nitrocellulose membrane with 0.2 µm pores for conducting immunoprinting;
- 5.1.2 0.5-10 µL and 100-1000 µL automatic pipettes, corresponding cone filters;
- 5.1.3 tubes, tube rack for dilutions of antibodies;
- 5.1.4 class-A graduated cylinders;
- 5.1.5 absorbent paper;
- 5.1.6 tweezers;
- 5.1.7 laboratory glassware to carry out the reaction: small crystalliser, Petri dish, tubes, stoppers, etc.;
- 5.1.8 platform shaker (for a reaction in a dish) or vortex mixer (for a reaction in a tube) with a maximum speed of 20 RPM.

5.2 Equipment required to prepare the solutions:

- 5.2.1 class-A calibrated flasks;

RECUEIL INTERNATIONAL DES METHODES D'ANALYSES – OIV
Detection of chitinase and thaumatin-like
proteins in white wines

- 5.2.2 pH meter;
- 5.2.3 precision weighing balance with an accuracy of 0.1 mg;
- 5.2.4 3000-g centrifuge and centrifuge tubes.

6. Sampling

The samples should be taken and stored at 4 °C so as not to modify the proteins naturally present in the wine.

6.1 Sample preparation

The samples (or laboratory samples) of wines are applied directly to the nitrocellulose membrane (5.1.1) using the pipette (5.1.2), without prior preparation.

7. Procedure

Analysis may be conducted on unfiltered wines on the sole condition that these wines do not contain bentonite in suspension. If this is the case, carry out centrifugation at 3000 g (5.2.4) for 10 min at room temperature.

As indicated in point 3, the immunological method of immunoprinting takes place in 3 steps, and the reactions are conducted at a room temperature of between 18 °C and 25 °C.

7.1 Application of the wine sample

Apply 5 µL (5.1.2) of test portion from the samples and standard colorimetric solutions to the nitrocellulose membrane (5.1.1).

Leave to dry for 15-20 min at room temperature.

7.2 Addition of monoclonal antibodies

7.2.1 Place the membrane in the dish or tube (5.1.7). The volume of the solutions will be dependent on the container and the size of the membrane. This membrane should be covered.

The volumes specified below are for a small Petri dish-type container (5.1.7).

Add the blocking solution (4.2.3). Mix for at least 30 minutes (5.1.8).

RECUEIL INTERNATIONAL DES METHODES D'ANALYSES – OIV
Detection of chitinase and thaumatin-like
proteins in white wines

7.2.2 Wash by draining off the solution, holding down the membrane if necessary with tweezers, before adding 20 mL of TBS (4.2.1) and mixing for several minutes (5.1.8).

Wash a second time as described above and drain off the solution.

7.2.3 Add 20 mL of primary antibody solution (4.2.4.1).

Mix for one hour (5.1.8).

Wash 3 times with the TBS-Tween 20 solution (4.2.2).

7.2.4 Add 20 mL of goat anti-rabbit-HRP secondary antibody solution (4.2.4.2).

Mix for one hour.

7.2.5 Wash with the TBS-Tween 20 solution (4.2.2) as described above for 5 min.

Wash 2 times with the TBS solution (4.2.1) as described above for 15 min.

Drain off the solution.

7.3 Revelation of the presence of unstable proteins

7.3.1 Mix the two solutions to reveal the unstable proteins (4.2.5.1 and 4.2.5.2) and place in contact with the membrane (5.1.1) prepared according to protocols 7.1 and 7.2, to which the wine has been applied, and stir.

A black-dark purple to mauve precipitate appears on the membrane where the unstable proteins are present.

The colour intensity is dependent upon the concentration of unstable proteins and therefore the risk of protein *cassee*.

After 20-30 min, when the spot corresponding with the application of the positive standard colorimetric solution (4.1.2) is very intense, stop the colouration by washing the nitrocellulose membrane (5.1.1) in water.

Place the membrane to be dried between 2 sheets of absorbent paper (5.1.5).

The results can be interpreted when the membrane is dry.

8. Results

For the results to be interpretable:

- the place of application of the positive standard colorimetric solution should show a spot of high colour intensity (dark purple-black),
- the place of application of the negative standard colorimetric solution should show no spots,

RECUEIL INTERNATIONAL DES METHODES D'ANALYSES – OIV
Detection of chitinase and thaumatin-like
proteins in white wines

- the background "noise" (place on the membrane where no sample has been applied) should be very light, even white.

A semi-quantitative result may be obtained by making a calibration curve based on a wine naturally rich in proteins, for which a dilution range will be used. This calibration curve will be dependent on the surface areas obtained through integration of the colour intensity of the spots corresponding to the formation of immunocomplexes. Analysis may be carried out with the same equipment as that used to analyse the electrophoresis gels described in the Method OIV-MA-AS315-12.

Interpretation of the results may also be carried out visually.

8.1 For direct control over the presence or absence of unstable proteins in wine

Proteins are present in the laboratory sample if the colour intensity of the spot obtained is higher than that of the spot for the negative standard colorimetric solution.

The colour intensity of the spot obtained after the reaction is proportional to the quantity of unstable proteins and, consequently, proportional to the risk of protein *casse* in this wine.

8.2 To verify the absence of proteins after treatment (in particular, with bentonite)

Proteins are present in the sample if the colour intensity of the spot obtained for the test portion without bentonite treatment is higher than that of the spot for the negative standard colorimetric solution.

In the case of application of a "range of treatment products (bentonite)" in a laboratory test, the colour intensity of the spots in each test portion should decrease as the treatment product concentration increases. Where this intensity is null or minimal for one spot but consistent in relation to the other samples in the range, the dose of the treatment product corresponding to the spot in question is applied to achieve protein stability in the tested wine.

RECUEIL INTERNATIONAL DES METHODES D'ANALYSES – OIV
Detection of chitinase and thaumatin-like
proteins in white wines

9. Annexes

Production of polyclonal antibodies directed against unstable proteins

The antibodies directed against unstable proteins in white and rosé wines may be prepared in rabbits. It is their specificity which makes the method reliable and precise.

9.1 Purification of Chitinase and Thaumatin-like proteins

9.1.1 List of products and equipment

- 9.1.1.1 Ultra-pure water: resistivity $\geq 18 \text{ M}\Omega\cdot\text{cm}$
- 9.1.1.2 Wine grape harvested at technological maturity (Chardonnay or Sauvignon blanc vine variety, for example)
- 9.1.1.3 Anhydrous sodium acetate: CAS No. 127-09-3
- 9.1.1.4 Triton X-100: CAS No. 9002-93-1
- 9.1.1.5 Anhydrous ammonium sulphate: CAS No. 127-09-3
- 9.1.1.6 Anhydrous sodium chloride (NaCl): CAS No. 7647-14-5
- 9.1.1.7 Anhydrous Tris-HCl: CAS No. 1185-53-1
- 9.1.1.8 37% Pure hydrochloric acid: CAS No. 7647-01-0
- 9.1.1.9 1M NaOH sodium hydroxide solution: CAS No. 1310-73-2
- 9.1.1.10 Laboratory glassware, including Class-A calibrated flasks and pipettes
- 9.1.1.11 Tweezers
- 9.1.1.12 10,000-g Centrifuge
- 9.1.1.13 Laboratory weighing balance with an accuracy of 0.1 mg
- 9.1.1.14 pH meter
- 9.1.1.15 Strong anionic resin
- 9.1.1.16 Anionic resin
- 9.1.1.17 Membrane with cut off of 10 kDa
- 9.1.1.18 Low-pressure liquid chromatography apparatus with concentration-gradient pump
- 9.1.1.19 Detector measuring the absorbance at $\lambda 280 \text{ nm}$
- 9.1.1.20 Conductivity detector

9.1.2 Preparation of sodium acetate buffer (9.1.1.3) diluted to 50 mM, 0.25% Triton X-100 (9.1.1.4) at pH 5

RECUEIL INTERNATIONAL DES METHODES D'ANALYSES – OIV
Detection of chitinase and thaumatin-like
proteins in white wines

Place the following successively in a 1-L calibrated flask (9.1.1.10):

- 4.1 g sodium acetate (9.1.1.3),
- 2.5 g Triton X-100 (9.1.1.4),
- make up to 1 L with ultra-pure water (9.1.1.1) and stir; adjust the pH to 5 using 37% HCl (9.1.1.8) in order to avoid having a basic environment that could have a harmful effect on the proteins to be extracted or impede their extraction.

9.1.3 Preparation of the 50-mM Tris-HCl buffer, pH 8.0

Place the following successively in a 1-L calibrated flask (9.1.1.10):

- 7.9 g anhydrous Tris-HCl (9.1.1.7)
- Make up to 1 L with ultra-pure water (9.1.1.1); adjust the pH to 8 using a 1M NaOH solution (9.1.1.9).

9.1.4 Preparation of the 50 mM Tris-HCl buffer, 100 mM NaCl

Place the following successively in a 1-L calibrated flask (9.1.1.10):

- 7.9 g anhydrous Tris-HCl (9.1.1.7),
- 5.8 g anhydrous sodium chloride (9.1.1.6),
- make up to 1 L with ultra-pure water (9.1.1.1) and mix.

9.1.5 Preparation of 100 mM sodium chloride solution

-Place the following successively in 1-L calibrated flask (9.1.1.10)

- 5.8 g anhydrous sodium chloride (9.1.1.6),
- make up to 1 L with ultra-pure water (9.1.1.1) and mix.

9.2 Procedure

Grapes from the Pinot noir or Chardonnay vine varieties are harvested at maturity and frozen at -20 °C. The seeds are removed from the frozen grapes before crushing. 3 g of seeded grapes are crushed into 10 mL of sodium acetate buffer (9.1.2), diluted to 50 mM, pH 5, containing 0.25% Triton X-100 (9.1.1.4). The insoluble material is removed by centrifugation (5 min at 3000 g) (9.1.1.12). The supernatant (2 mL) is then frozen overnight at -20 °C for clarification purposes. The extract is then centrifuged at 10,000 g for 15 min to remove the insoluble material.

RECUEIL INTERNATIONAL DES METHODES D'ANALYSES – OIV
Detection of chitinase and thaumatin-like
proteins in white wines

Ammonium sulphate (9.1.1.5) is added to the supernatant up to a concentration of 30%. The mixture is mixed for 1 hour at 4 °C then centrifuged once more as described above.

Ammonium sulphate (9.1.1.5) is again added to the supernatant up to a final concentration of 60%. The mixture is mixed for 2 hours at 4 °C then centrifuged once more as described above.

The protein precipitate is collected then re-dissolved in 1 mL of 50 mM Tris-HCl buffer, pH 8.0 (9.1.3). The proteins are bound to a column containing a strong anionic resin (5 x 30 cm) (9.1.1.15). The column is washed with the Tris-HCl buffer described above. Chitinase and Thaumatin-like proteins are then extracted using a Tris-HCl buffer containing 100 mM NaCl. All the fractions are collected then desalinated on a membrane with a MWCO of 10 kDa (9.1.1.17) using the 50 mM Tris-HCl buffer, pH 8.0 (9.1.4.3). The desalinated protein fractions are then loaded onto a low-pressure chromatography column (9.1.1.18) containing an anionic resin (9.1.1.16). Elution is carried out with 120 mL of a NaCl (9.1.5) gradient ranging from 0 to 100 mM by means of a concentration-gradient pump using a solution A of ultra-pure water (9.1.1.1) and a solution B of sodium chloride, 100 mM (9.1.5). The protein and salt concentrations are estimated respectively by measuring the absorbance at 280 nm and the conductivity of the fluids exiting the column using detectors (9.1.1.19 and 9.1.1.20). The Chitinase and Thaumatin-like protein fractions thus purified and separated are used for the production of antibodies.

9.3 Production of anti-Chitinase and Thaumatin-like polyclonal antibodies in rabbits

The protocol used is identical to that described in the Method OIV-MA-AS315-12.

10. Bibliography

1. **Anonymous.** 2004. "Determination of Plant Proteins in Wines and Musts," OIV, *Resolution Oeno 24/2004*. 1-7. (Method OIV-MA-AS315-12).
2. **Derckel, J. P.; Audran, J. C.; Haye, B.; Lambert, B. and Legendre, L.** 1998. "Characterization, Induction by Wounding and Salicylic Acid, and Activity against *Botrytis cinerea* of Chitinases and Beta-1,3-Glucanases of Ripening Grape Berries." *Physiologia Plantarum*, 104 (1), 56-64.

RECUEIL INTERNATIONAL DES METHODES D'ANALYSES – OIV
Detection of chitinase and thaumatin-like
proteins in white wines

3. **Manteau, S.; Lambert, B.; Jeandet, P. and Legendre, L.** 2003. "Changes in Chitinase and Thaumatin-Like Pathogenesis-Related Proteins of Grape Berries During the Champagne Winemaking Process." *American Journal of Enology and Viticulture*, 54 (4), 267-72.
4. **Manteau, S. and Poinsaut, P.** 2010. "Instabilité Protéique Des Vins Blancs Et Rosés. Partie 2/2: Comparaison Des Tests De Stabilité Protéique Dans Les Vins Blancs Et Rosés Et Mise Au Point D'un Nouveau Test: L'immunoTest [®]." *Revue des Œnologues*, 135, 23-27.
5. **Manteau, S.; Sauvage, F.-X.; Poinsaut, P.; Scotti, B.; Sieczkowski, N. and Moutounet, M.** 2006. "Haze in White Wine: Involvement of Proteins Other Than Pathogenesis-Related Proteins in Spontaneous Haze," Eds. P. Jeandet, C. Clement and A. Conreux, *Macrowine: Macromolecules and Secondary Metabolites of Grape and Wine*. Reims: Intercept Publishers - Lavoisier, 165-68.
6. **Ribéreau-Gayon, J. and Peynaud, E.** 1961. "Précipitation Des Protéines," *Traité d'Oenologie. Tome II - Composition, Transformations Et Traitements Des Vins*. Librairie Polytechnique Ch. Béranger, 346-356.
7. **Waters, E.; Hayasaka, Y.; Tattersall, D.; Adams, K. and Williams, P.** 1998. "Sequence Analysis of Grape (*Vitis Vinifera*) Berry Chitinases That Cause Haze Formation in Wines." *Journal of Agricultural and Food Chemistry*, 46 (12), 4950-57.

Method OIV-MA-AS315-30

Type IV method

**Determination of alkylphenols in wines by gas
chromatography-mass spectrometry (GC-MS or
GC-MS/MS)**
(OIV-OENO 620-2020)

1. Scope of application

The following method allows for the determination of the following molecules:

	Range studied
• 2-tert-butylphenol	1-100 µg/L
• 4-tert-butylphenol	1-100 µg/L
• 6-methyl-2-tert-butylphenol	1-100 µg/L
• 4-methyl-2-tert-butylphenol	1-100 µg/L
• 5-methyl-2-tert-butylphenol	1-100 µg/L
• 4,6-di-methyl-2-tert-butylphenol	1-100 µg/L
• 2,6-di-tert-butylphenol	1-100 µg/L
• 2,4-di-tert-butylphenol	1-100 µg/L

2. Standard references

- ISO 78-2: Chemistry – Layouts for standards,
- ISO 3696: Water for analytical laboratory use,
- Resolution OIV-OENO 418-2013.

3. Principle of the method

The method describes the analysis, on the one hand, by gas chromatography coupled with mass spectrometry (GC-MS), and on the other, by gas chromatography coupled with tandem mass spectrometry (GC-MS/MS). The sample is extracted in the headspace using the solid-phase microextraction (SPME) technique.

4. Reagents and working solutions

During analysis – unless otherwise indicated – only quality, recognised analytical reagents and distilled or demineralised water, or water of equivalent purity, are to be used.

4.1. Reagents

- 4.1.1. Quality I or II water for analytical usage (ISO 3696 standard)
- 4.1.2. Absolute ethanol (CAS No. 64-17-5)
- 4.1.3. Sodium chloride (CAS No. 7647-14-5)
- 4.1.4. 4-tert-butylphenol-d13 (CAS 225386-58-3)
- 4.1.5. 4-tert-butylphenol (CAS No. 98-54-4)
- 4.1.6. 2-tert-butylphenol (CAS No. 88-18-6)
- 4.1.7. 4-methyl-2-tert-butylphenol (CAS No. 2409-55-4)
- 4.1.8. 5-methyl-2-tert-butylphenol (CAS No. 88-60-8)
- 4.1.9. 6-methyl-2-tert-butylphenol (CAS No. 2219-82-1)
- 4.1.10. 4,6-di-methyl-2-tert-butylphenol (CAS No. 1879-09-0)
- 4.1.11. 2,4-di-tert-butylphenol (CAS No. 96-76-4)
- 4.1.12. 2,6-di-tert-butylphenol (CAS No. 128-39-2)

4.2. Stock solutions

Individual stock solutions at 1 g/L are prepared in ethanol for each alkylphenol as well as for the internal standard (e.g. 4-tert-butylphenol-d13).

Based on the individual stock solutions, working solutions are prepared in ethanol to the desired concentrations so as to cover the whole measurement range.

4.3 Calibration solutions

In order to ensure the best possible traceability to the International System of Units (SI), the calibration range should be made up of solutions and powders with (a high grade of) purity of different alkylphenols, prepared by weight or volumetrically according to the SI.

The calibration range is carried out with 12% (v/v) ethanol (4.1.2), with the range of measurement (1-100 $\mu\text{g}\cdot\text{L}^{-1}$) covering 5 points, for example. These solutions are prepared at the time of analysis for immediate use after preparation (within a few hours).

The calibration equation obtained is generally a quadratic function.

5. Apparatus

- 5.1. GC-MS equipped with a “split-splitless” injector and mass-spectrometer detector or tandem mass spectrometer
- 5.2. Capillary column with apolar stationary phase, 5% phenylmethylpolysiloxane (e.g. 5MS, 30 m x 0.25 mm x 0.25 µm film) or equivalent
- 5.3. Calibrated 100-µL, 1-mL and 10-mL micropipettes
- 5.4. 20-mL SMPE vial, sealable by a perforated cap and Teflon seal
- 5.5. Solid-phase microextraction system (SPME) with polydimethylsiloxane-film-coated fibre of 100 µm in thickness, or equivalent
- 5.6. Balance
With traceability to the SI and 0.1 mg precision.
- 5.7. Measuring glassware

The measuring glassware for the preparation of reagents and calibration solutions is class A.

6. Preparation of samples

The internal standard 4-tert-butylphenol-d13 is used here by way of example; it is possible to use other internal standards.

A sample of 10 mL wine is placed in a 20-mL SPME glass vial (5.4) with roughly 2 g NaCl (4.1.3) and 50 µL 4-tert-butylphenol-d13 (internal standard) solution at 5 mg/L (4.1.4).

The vial is closed with a perforated cap and Teflon seal (5.4).

7. GC-MS Procedure

The procedure is given by way of example. The GC-MS technique used allows for the necessary variations or optimisations to be made according to the equipment configuration.

7.1. Extraction

The headspace SPME extraction is carried out for 20 minutes at 40 °C.

7.2. Injection

Desorption from the fibre is carried out for 10 minutes in the injector.

Injector at 260 °C in splitless mode

Helium flow rate: 1 mL/min

7.3 Gas chromatography parameters

Column: 5MS UI 30 m x 0.25 mm x 0.25 µm

Transfer line temperature: 300 °C

Oven: 50 °C

Then 10 °C/min up to 300 °C

Then 300 °C for 3 minutes

Run time: 28.0 minutes

7.4 Acquisition

Source temperature: 250 °C

Quad temperature: 150 °C

COMPENDIUM OF INTERNATIONAL ANALYSIS OF METHODS - OIV
Determination of alkylphenols in wines by gas chromatography-
mass spectrometry (GC-MS or GC-MS/MS)

Acquisition: SIM

	Run time (min)	Ions (quantified)	Ions (qualified)
2-tert-butylphenol	8.9	135	107-150
4-tert-butylphenol-d13 (IS)	9.1	145	113-163
4-tert-butylphenol	9.2	135	107-150
6-methyl-2-tert-butylphenol	9.4	149	164-121
4-methyl-2-tert-butylphenol	10.0	149	164-121
5-methyl-2-tert-butylphenol	10.2	149	164-121
4,6-dimethyl-2-tert-butylphenol	10.5	163	135-178
2,6-di-tert-butylphenol	11.2	191	206-192
2,4-di-tert-butylphenol	12.0	191	206-192

Table 1: Ions used in mass spectrometry.

8. GC-MS/MS procedure

The procedure is given by way of example. The GC-MS/MS technique used allows for the necessary variations or optimisations to be made according to the equipment configuration.

8.1. Extraction

The headspace SPME extraction is carried out for 5 minutes at 40 °C.

8.2. Injection

Desorption from the fibre is carried out for 8 minutes in the injector.

Injector at 250 °C in pulsed-split mode with a split ratio of 2:1

Helium flow rate: 2 mL/min

8.3. Gas chromatography parameters

Column: 5MS UI 30 mx0.25 mm x 0.25 µm or equivalent

Transfer line: 300 °C

Oven: 50 °C

Then 25 °C/min up to 130 °C

Then 10 °C/min up to 170 °C

Then 25 °C/min up to 300 °C

Then 300 °C for 3 minutes

Run time: 15.4 minutes

8.4. Acquisition

Source temperature: 250 °C

Quad temperature: 150 °C

Acquisition: MRM

	Run time (min)	Quantification transitions	Qualification transitions
2-tert-butylphenol	5.0	135>107	150>107 & 150>135
4-tert-butylphenol-d13 (IS)	5.1	145>113	163>113 & 163>145
4-tert-butylphenol	5.2	135>107	150>107 & 150>135
6-methyl-2-tert-butylphenol	5.3	149>121	164>121 & 164>149
4-methyl-2-tert-butylphenol	5.7	149>121	164>121 & 164>149

COMPENDIUM OF INTERNATIONAL ANALYSIS OF METHODS - OIV
Determination of alkylphenols in wines by gas chromatography-
mass spectrometry (GC-MS or GC-MS/MS)

5-methyl-2-tert-butylphenol	5.8	149>121	164>121 & 164>149
4,6-dimethyl-2-tert-butylphenol	6.1	163>135	178>135 & 178>163
2,6-di-tert-butylphenol	6.6	206>191	191>163 & 191>57
2,4-di-tert-butylphenol	7.2	191>57	191>163 & 206>191

Table 2: Ions used in tandem mass spectrometry.

9. Expression of results

The results are expressed in µg/L.

COMPENDIUM OF INTERNATIONAL ANALYSIS OF METHODS - OIV
Determination of alkylphenols in wines by gas chromatography-
mass spectrometry (GC-MS or GC-MS/MS)

10. Annex 1: Results of internal validation

The performance was measured using an intra-laboratory experimental approach: 5 materials covering the scope of application of the method (1; 5; 25; 50; 100 µg/L) were formulated, within a synthetic wine matrix (hydroalcoholic solution at 12% (v/v), 6 g/L tartaric acid, pH adjustment to 3.5 with 1M NaOH).

Each material was analysed 5 times under conditions of intermediate precision with 2 repetitions of each analysis. The analyses were performed in September and October 2018.

The calculations were made according to Resolution OIV-OENO 418-2013, “Practical Guide for the assessment, quality control, and uncertainty analysis of an oenological analysis method”.

GC-MS	% CV (k=2) Intermediate precision	CV _r (%) Repeatability	Validated LOQ
2-tert-butylphenol	6.7%	4.3%	1 µg/L
4-tert-butylphenol	7.3%	5.1%	1 µg/L
6-methyl-2-tert-butylphenol	12.1%	10.2%	1 µg/L
4-methyl-2-tert-butylphenol	6.0%	4.6%	1 µg/L
5-methyl-2-tert-butylphenol	6.4%	4.9%	1 µg/L
4,6-dimethyl-2-tert-butylphenol	12.7%	10.5%	1 µg/L
2,6-di-tert-butylphenol	19.5%	14.6%	1 µg/L
2,4-di-tert-butylphenol	11.9%	9.9%	1 µg/L

Table 3: Performance obtained with mass spectrometry.

COMPENDIUM OF INTERNATIONAL ANALYSIS OF METHODS - OIV
Determination of alkylphenols in wines by gas chromatography-
mass spectrometry (GC-MS or GC-MS/MS)

GC-MS/MS	% CV (k=2) Intermediate precision	CV _r (%) Repeatability	LOQ
2-tert-butylphenol	11.3%	10.1%	1 µg/L
4-tert-butylphenol	10.4%	11.0%	1 µg/L
6-methyl-2-tert-butylphenol	13.9%	13.5%	1 µg/L
4-methyl-2-tert-butylphenol	11.1%	9.6%	1 µg/L
5-methyl-2-tert-butylphenol	12.3%	10.3%	1 µg/L
4,6-dimethyl-2-tert-butylphenol	13.4%	12.6%	1 µg/L
2,6-di-tert-butylphenol	16.6%	16.8%	1 µg/L
2,4-di-tert-butylphenol	14.5%	12.4%	1 µg/L

Table 4: Performance obtained with tandem mass spectrometry.

COMPENDIUM OF INTERNATIONAL ANALYSIS OF METHODS - OIV

Determination of alkylphenols in wines by gas chromatography-mass spectrometry (GC-MS or GC-MS/MS)

11. Annex 2: Example chromatograms and calibration curves

11.1 2-tert-butylphenol

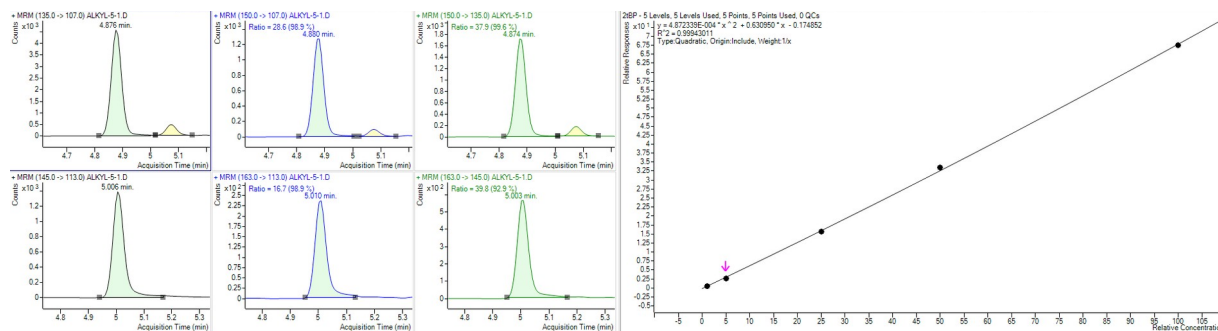

11.2 4-tert-butylphenol

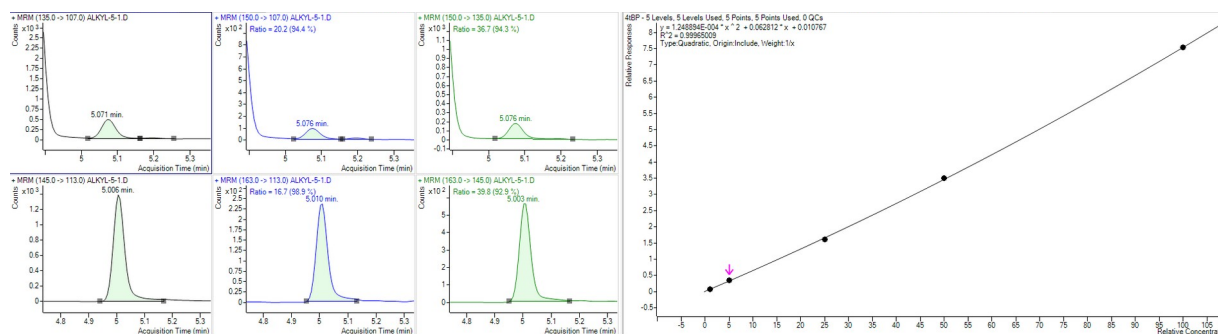

COMPENDIUM OF INTERNATIONAL ANALYSIS OF METHODS - OIV
Determination of alkylphenols in wines by gas chromatography-mass spectrometry
(GC-MS or GC-MS/MS)

11.3 6-methyl-2-tert-butylphenol

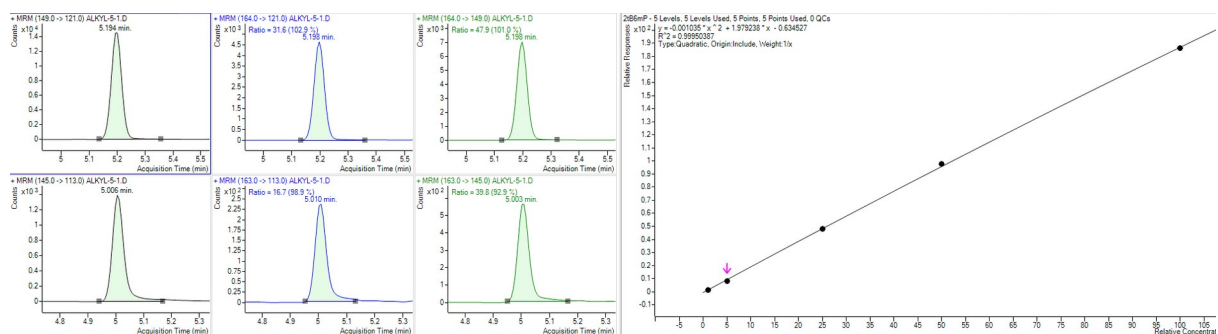

11.4 4-methyl-2-tert-butylphenol

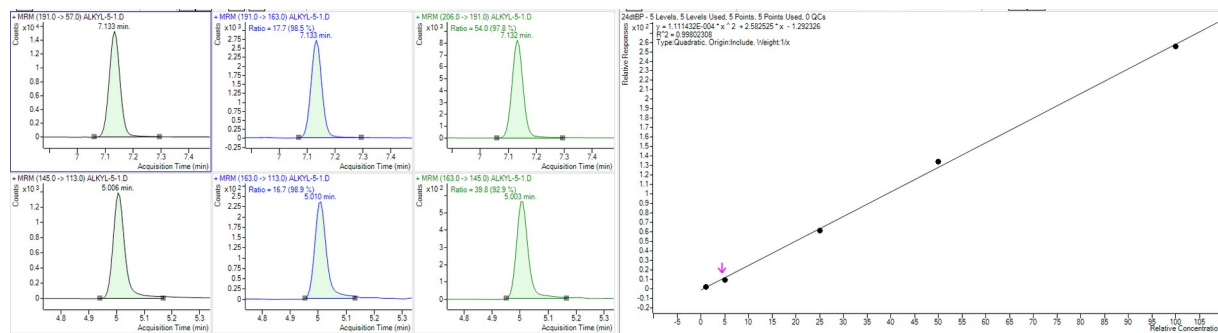

COMPENDIUM OF INTERNATIONAL ANALYSIS OF METHODS - OIV
Determination of alkylphenols in wines by gas chromatography-mass spectrometry
(GC-MS or GC-MS/MS)

11.5 5-methyl-2-tert-butylphenol

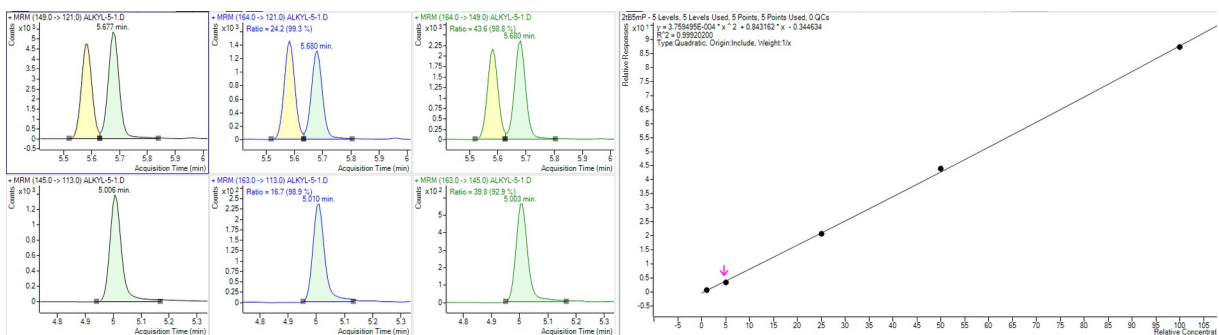

11.6 4,6-dimethyl-2-tert-butylphenol

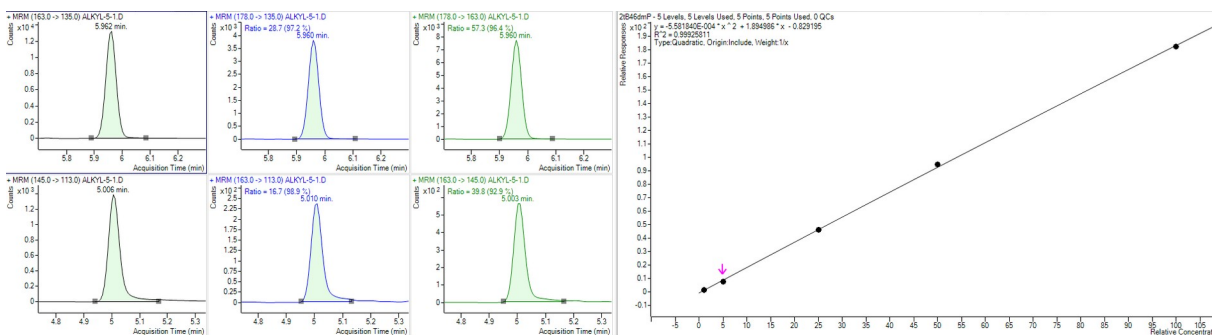

COMPENDIUM OF INTERNATIONAL ANALYSIS OF METHODS - OIV
Determination of alkylphenols in wines by gas chromatography-mass spectrometry
(GC-MS or GC-MS/MS)

11.7 2,6-di-tert-butylphenol

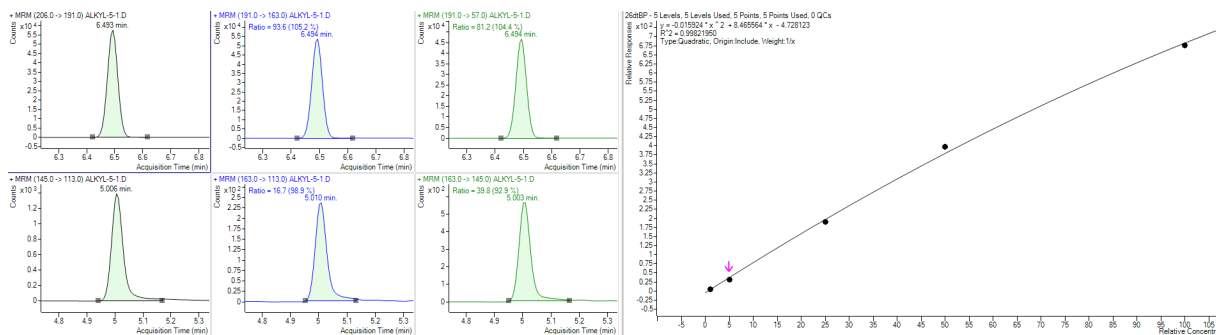

11.8 2,4-di-tert-butylphenol

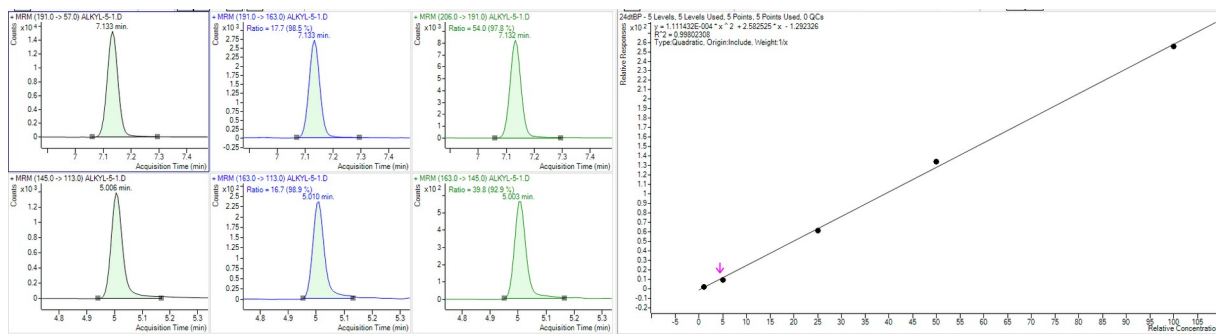

COMPENDIUM OF INTERNATIONAL METHODS OF ANALYSIS – OIV
Qualitative determination of sweeteners in wine by liquid
chromatography coupled with mass spectrometry (LC-MS)

Method OIV-MA-AS315-31

Type IV Method

Qualitative determination of sweeteners in wine by liquid
chromatography coupled with mass spectrometry (LC-MS)

(OIV-OENO 636-2021)

1. Scope

This method is suitable for the determination of presence of five artificial sweeteners (aspartame, potassium acesulfame, sodium cyclamate, saccharin and sucralose) as well as the natural sweetener stevioside in white, rosé and red wine.

2. Definitions

ESI – Electrospray Ionisation

LC – Liquid chromatography

LC-MS – Liquid chromatography coupled with mass spectrometry

m/z – Mass to charge ratio

MS – Mass spectrometry

MS/MS – Mass spectrometry acquisition mode measuring product ions

QTOF – Quadrupole time-of-flight mass spectrometry

RP – Reverse phase

RT – Retention time

UHPLC – Ultra-high-performance liquid chromatography

COMPENDIUM OF INTERNATIONAL METHODS OF ANALYSIS – OIV
Qualitative determination of sweeteners in wine by liquid
chromatography coupled with mass spectrometry (LC-MS)

3. Principle

Wine is analysed directly using a liquid chromatography coupled with mass spectrometry system (LC-MS). In liquid chromatography (LC), separation is performed using a reverse phase (RP) column and detection is accomplished by mass spectrometry (MS) according to the compounds' mass to charge ratio (m/z). The MS data combined with the retention time (RT) are used for the identification and quantitation of sweeteners.

4. Reagents and materials

4.1. Reagents:

- 4.1.1. Acetonitrile, purity ≥ 99.95 % (CAS Number 75-05-8)
- 4.1.2. Purified water: 18 M Ω .cm, TOC ≤ 5 μ g/L
- 4.1.3. Formic Acid, purity ≥ 98 % (CAS Number 64-18-6)
- 4.1.4. Aspartame, purity ≥ 99.0 % (CAS Number 22839-47-0)
- 4.1.5. Acesulfame K, purity ≥ 99.9 % (CAS Number 55589-62-3)
- 4.1.6. Cyclamate, Sodium, purity ≥ 99.8 % (CAS Number 139-05-9)
- 4.1.7. Saccharin, purity ≥ 99 % (CAS Number 81-07-2)
- 4.1.8. Sucralose, purity ≥ 98.0 % (CAS Number 56038-13-2)
- 4.1.9. Stevioside, purity ≥ 95.0 % (CAS Number 57817-89-7)
- 4.1.10. Wines representative of the working matrices and previously verified to be absent of any sweeteners in order to be used for the preparation of calibration solutions and standards.

4.2. Solution preparation (as an example)

Standards and calibration solutions are kept in the fridge at approximately 6 °C. Aspartame solutions are unstable in acid media. Therefore, they must be prepared fresh each time the standard is analysed.

4.2.1. Standard solutions

Individual standard solutions at 1 g/L are prepared, e.g., by dissolving 10.0 mg of each sweetener in 10 mL volumetric flasks and filling up to the mark with water (4.1.2.) or with ethanol solution at 12% V/V.

4.2.2. Calibration standards

COMPENDIUM OF INTERNATIONAL METHODS OF ANALYSIS – OIV
Qualitative determination of sweeteners in wine by liquid
chromatography coupled with mass spectrometry (LC-MS)

Calibration standards are prepared and analysed by LC-MS as any other sample (see 6.).

The calibration standards are prepared in wine (4.1.10.) by diluting the appropriate amount of standard solution (4.2.1.) to obtain the concentrations 50 µg/L, 100 µg/L, 500 µg/L and 1000 µg/L of each sweetener.

If better method performance is needed it is recommended to perform calibration with the same matrix being evaluated.

5. Apparatus

- 5.1. Syringe filters: 0.2 µm polypropylene membrane, 25 mm diameter.
- 5.2. Laboratory glassware, namely class A volumetric flasks.
- 5.3. Analytical balance with a resolution of ±0.0001 g.
- 5.4. Micropipettes for volumes from 5 µL to 1000 µL.
- 5.5. High Performance Liquid Chromatography instrument coupled with mass spectrometer.
 - 5.5.1. Standard HPLC and UPLC systems are possible given that the chromatographic separation is adjusted accordingly.
 - 5.5.2. Several MS system configurations are possible such as quadrupole, ion trap, time-of-flight and also hybrid systems.

6. Sampling

Each wine sample is prepared by filtration with a syringe filter (5.1.) prior to injection.

If necessary, samples are degassed beforehand using, for example, an ultrasound bath or nitrogen bubbling. If concentrations fall outside the calibration range, samples should be diluted.

Better performance may also be achieved with additional sample preparation steps such as dilution (relying on the instrument sensitivity), sample cleanup and extraction.

7. Procedure

COMPENDIUM OF INTERNATIONAL METHODS OF ANALYSIS – OIV
Qualitative determination of sweeteners in wine by liquid chromatography coupled with mass spectrometry (LC-MS)

The following description, given as an example, refers to a UHPLC-QTOF instrument equipped with an ESI source. Modifications may occur according to the type of equipment or manufacturer's instructions.

7.1. LC analysis:

- Mobile phase A: purified water (4.1.2.) with 0.1 % formic acid (4.1.3.)
- Mobile phase B: acetonitrile (4.1.1.) with 0.1 % formic acid (4.1.3.)
- Injection volume: 2 μ L
- Sampler temperature: 10 °C
- Column: RP C8 2.1 mm x 100 mm, 1.9 μ m
- Column Oven: 30 °C

- Gradient:

Time Min	Flow mL/min	% A	% B
0	0.4	90	10
3	0.4	60	40
3	0.4	1	99
4	0.4	1	99
4	0.8	1	99
5.5	0.8	1	99
5.5	0.5	90	10
9.5	0.5	90	10
9.5	0.4	90	10
10	0.4	90	10

7.2. Mass Spectrometer parameters:

- ESI: negative ionisation
- Source Temp: 200 °C
- Capillary Voltage: 3000 V
- Acquisition Mode: broadband collision-induced dissociation (bbCID)
 - Consists of alternating acquisition of spectra of Full Scan and MS/MS modes (acquisition of precursor and product ions respectively)
- Collision Energy: 30 eV
- Acquisition spectra rate: 2.0 Hz
- Dry Gas Flow: 8 L/min;

COMPENDIUM OF INTERNATIONAL METHODS OF ANALYSIS – OIV
Qualitative determination of sweeteners in wine by liquid chromatography coupled with mass spectrometry (LC-MS)

- Nebuliser pressure: 2.0×10^5 Pa (2.0 bar)

8. Identification

Sweetener identification is confirmed using a standard for each compound (4.1.4., 4.1.5., 4.1.6., 4.1.7., 4.1.8. and 4.1.9.). The data gathered for peak confirmation is the RT for guidance (these may vary depending on the chromatographic parameters) and m/z of the precursor and product ions (Table 1).

Table 1 – Sweeteners identification data: RT, precursor m/z and product m/z

Sweetener	RT min	Ion	Precursor m/z	Product m/z
Acesulfame K	1.24	[M] ⁻	<u>161.9867</u>	77.9655
Aspartame	2.30	[M-H] ⁻	<u>293.1143</u>	261.0881
Cyclamate Na	1.66	[M] ⁻	<u>178.0543</u>	79.9574
Saccharin	1.55	[M-H] ⁻	<u>181.9917</u>	41.9985
Sucralose	2.14	[M-H] ⁻	<u>395.0073</u>	359.0306
Stevioside	3.63	[M-H] ⁻	803.3707	<u>641.3026</u>

Note: The ions used for quantitation are underlined in Table 1.

Ion signals are monitored with extracted ion chromatograms with ± 3 mDa tolerance (Figure 1).

COMPENDIUM OF INTERNATIONAL METHODS OF ANALYSIS – OIV
Qualitative determination of sweeteners in wine by liquid
chromatography coupled with mass spectrometry (LC-MS)

Figure 1 – Precursor and product peak confirmation for 250 µg/L standard

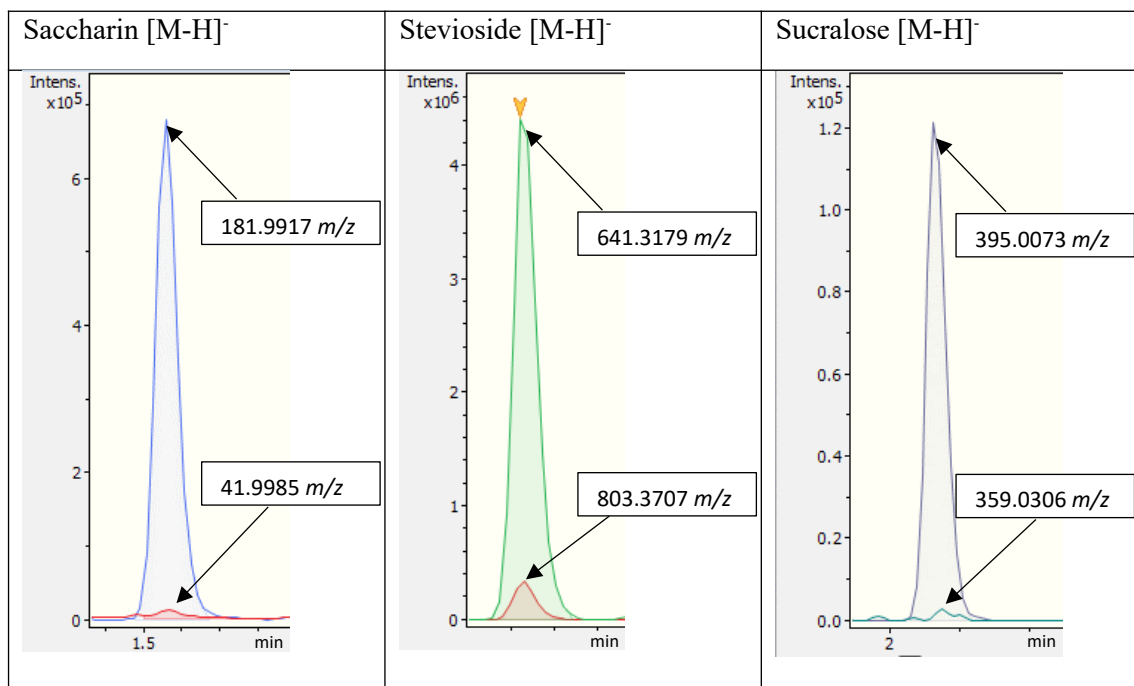
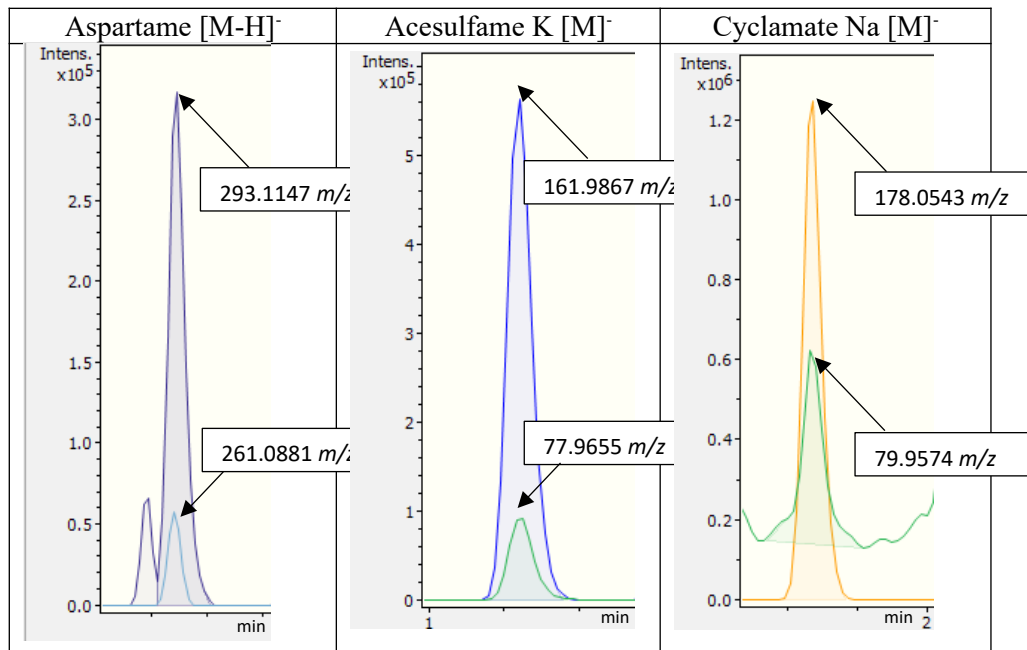

Note: An example of low standard sensitivity and additional transitions are given in appendix

COMPENDIUM OF INTERNATIONAL METHODS OF ANALYSIS – OIV
Qualitative determination of sweeteners in wine by liquid
chromatography coupled with mass spectrometry (LC-MS)

9. Calculus

Results are calculated from the calibration curve which is obtained with the amount (µg/L) vs the peak area of each sweetener:

$$C = A_s - \frac{\int i}{S} i$$

Where C is the sweetener concentration (µg/L), A_s is the sample peak area, $\int i$ is the calibration curve Y-axis interception point and S is the calibration curve slope.

10. Results

Concentrations are expressed in µg/L without decimals.

11. Internal validation

11.1. Matrices

Validation was performed using a total of 43 different wines: 20 red wines, 10 rosé wines and 13 white wines. These wines were selected from several regions with the aim of obtaining great variability of characteristics in order to make a comprehensive approach. Bellow there is a table summarizing the major characteristics of the wines.

Table 2 – Matrices main characteristics

	Red wine (R)		Rosé wine (Ro)		White wine (W)	
Regions	Alentejo	4	Douro	3	Açores	1
	Bairrada	1	Vinho Verde	1	Alentejo	2
	Dão	3	Other ⁽¹⁾	6	Dão	1
	Douro	4			Douro	1
	Lisboa	1			Lisboa	1
	Valladolid	1			Vinho Verde	4

COMPENDIUM OF INTERNATIONAL METHODS OF ANALYSIS – OIV
Qualitative determination of sweeteners in wine by liquid chromatography coupled with mass spectrometry (LC-MS)

	Other ⁽¹⁾	6	Other ⁽¹⁾	3
Alcoholic Strength by Volume % v/v	12.1 – 17.2		9.8 – 12.6	8.7 – 13.6
Sugar content g/L (glucose + fructose)	0.5 – 108.0		0.7 – 28.8	0.2 – 17.1
Total Acidity g/L (tartaric acid)	4.6 – 6.4		4.7 – 6.0	5.2 – 7.1
pH	3.5 – 3.8		3.2 – 3.5	3.2 – 3.4
Intensity	2.4 – 16.2		0.1 – 0.5	0.03 – 0.29 ⁽²⁾

⁽¹⁾ Without geographical indication

⁽²⁾ Absorbance at 420 nm instead of intensity

11.2. Linearity

The method proved to be linear within a range of concentrations between 50 µg/L and 1000 µg/L

11.3. Calibration

A total of 14 independent calibrations were made counting 6 red wines, 4 rosé wines and 4 white wines. Then, for each compound, calibrations were made considering 3 different approaches:

- One unified calibration for all the matrices
- 2 groups of matrices consisting in one group for white wines and another group with the remaining wines (red wines and rosé wines)
- 3 groups of matrices consisting of white wines, rosé wines and red wines

Herein presented are the optimized results of the validation study. According to the selected calibration conditions, for acesulfame, saccharin and sucralose calibration functions and subsequent calculations were performed considering one group for white wines and a second group with the remaining

COMPENDIUM OF INTERNATIONAL METHODS OF ANALYSIS – OIV
Qualitative determination of sweeteners in wine by liquid
chromatography coupled with mass spectrometry (LC-MS)

matrices, red wines and rosé wines. For aspartame, cyclamate and stevioside three groups of matrices were considered: red wines, rosé wines and white wines.

Table 3 – Calibration scheme for each compound

Calibrations	Individual			Combined
	White wine	Rosé wine	Red wine	
Matrices				Red wines + Rosé wines
Acesulfame	X			X
Aspartame	X	X	X	
Cyclamate	X	X	X	
Saccharin	X			X
Stevioside	X	X	X	
Sucralose	X			X

Given the heteroskedasticity and normal distribution of the residuals, the regression model employed was the weighted least square regression.

As an example, sucralose for the group of red and rosé wines at a concentration range 50 µg/L to 1000 µg/L is presented below.

Figure 2 – Calibration curve, standardized residuals and Q-Q plot for the combined red and rosé wines calibration for sucralose

COMPENDIUM OF INTERNATIONAL METHODS OF ANALYSIS – OIV
Qualitative determination of sweeteners in wine by liquid chromatography coupled with mass spectrometry (LC-MS)

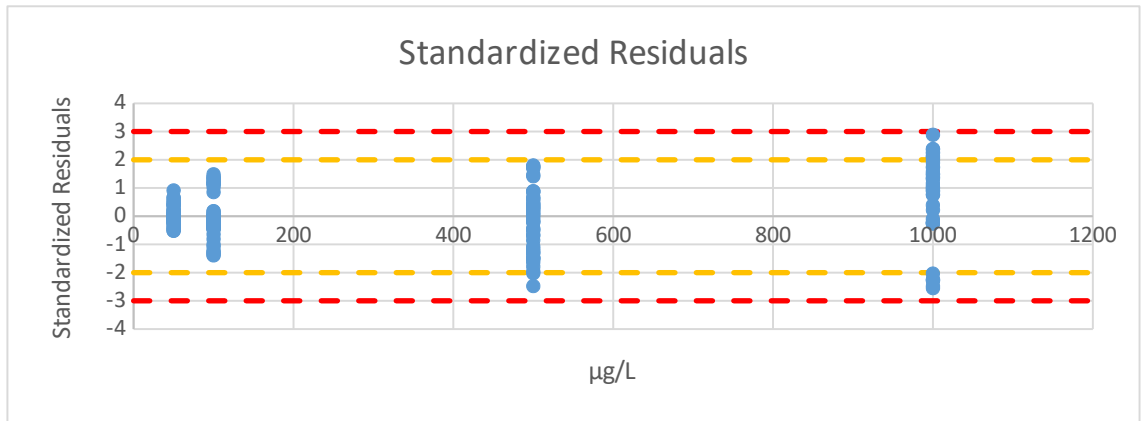
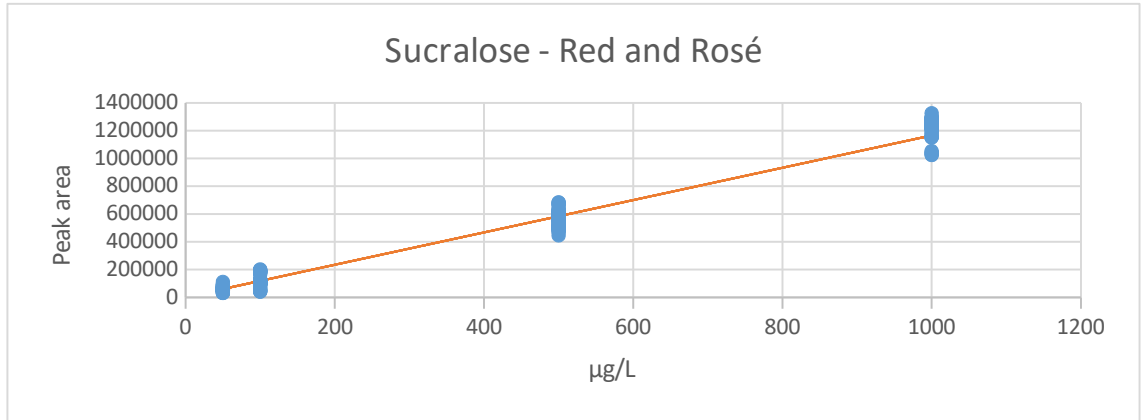

yellow	2x standard deviation
red	3x standard deviation

COMPENDIUM OF INTERNATIONAL METHODS OF ANALYSIS – OIV
Qualitative determination of sweeteners in wine by liquid chromatography coupled with mass spectrometry (LC-MS)

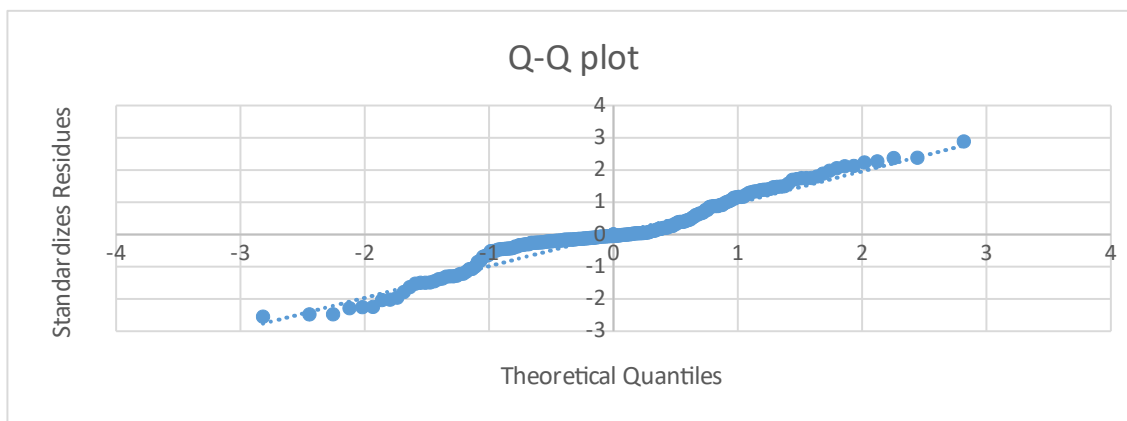

11.4. Limits of detection and limits of quantitation

The limits of quantitation were obtained through calculation from the calibration curves

Table 4 – LOD and LOQ values obtained for each compound

	LOD (mg/L)			LOQ (mg/L)		
	White wine	Rosé wine	Red wine	White wine	Rosé wine	Red wine
Acesulfame K	0.003	0.003		0.011	0.011	
Aspartame	0.004	0.006	0.004	0.014	0.019	0.014
Cyclamate Na	0.002	0.005	0.004	0.006	0.015	0.014
Saccharin	0.002	0.005		0.006	0.016	
Stevioside	0.002	0.002	0.005	0.005	0.005	0.016

OIV-MA-AS315-31: R2021

COMPENDIUM OF INTERNATIONAL METHODS OF ANALYSIS – OIV
Qualitative determination of sweeteners in wine by liquid
chromatography coupled with mass spectrometry (LC-MS)

Sucralose	0.014	0.007	0.048	0.022
------------------	-------	-------	-------	-------

11.5. Repeatability

Repeatability was assessed at three spiking levels: 50 µg/L corresponding to the reporting limit, 250 µg/L and 1000 µg/L. This evaluation is based on 8 replicate injections at each spiking level and for each matrix.

In the following tables the repeatability values obtained for each sweetener are presented including the mean concentration measured in each sample, the standard deviation (Std. Dev.), the percentual relative standard deviation for repeatability (RSDr %) and the Horwitz Ratio for repeatability (HorRat (r)).

Table 5 – Repeatability values for potassium acesulfame at 3 spiking levels

Acesulfame	White wine (W)								
Sample	W1	W2	W3	W4	W5	W6	W7	W8	W9
Mean µg/L	45	42	49	233	207	240	1036	926	1060
Std. Dev.	1.4	2.1	0.8	3.3	5.2	2.6	13.2	13.7	15.8
Recovery %	89 %	84 %	98 %	93 %	83 %	96 %	104 %	93 %	106 %
RSDr %	3.2 %	5.0 %	1.6 %	1.4 %	2.5 %	1.1 %	1.3 %	1.5 %	1.5 %
HorRat (r)	0.13	0.20	0.06	0.07	0.13	0.05	0.08	0.09	0.09

Acesulfame	Rosé wine (Ro)
-------------------	-----------------------

COMPENDIUM OF INTERNATIONAL METHODS OF ANALYSIS – OIV
Qualitative determination of sweeteners in wine by liquid
chromatography coupled with mass spectrometry (LC-MS)

e									
Sample	Ro1	Ro2	Ro3	Ro4	Ro5	Ro6	Ro7	Ro8	Ro9
Mean µg/L	49	52	53	248	248	247	1063	1091	1097
Std. Dev.	2.0	1.2	1.4	2.9	3.5	3.9	14.1	13.2	15.5
Recovery %	98 %	104 %	107 %	99 %	99 %	99 %	106 %	109 %	110 %
RSDr %	4.1 %	2.3 %	2.6 %	1.2 %	1.4 %	1.6 %	1.3 %	1.2 %	1.4 %
HorRat (r)	0.17	0.09	0.10	0.06	0.07	0.08	0.08	0.08	0.09

Acesulfame	Red wine (R)								
Sample	R1	R2	R3	R4	R5	R6	R7	R8	R9
Mean µg/L	56	50	57	275	241	260	1195	1064	1160
Std. Dev.	1.2	2.0	1.4	3.2	5.1	4.3	13.8	14.5	10.0
Recovery %	112 %	101 %	115 %	110 %	96 %	104 %	120 %	106 %	116 %
RSDr %	2.1 %	3.9 %	2.4 %	1.2 %	2.1 %	1.6 %	1.2 %	1.4 %	0.9 %
HorRat (r)	0.08	0.16	0.10	0.06	0.11	0.08	0.07	0.09	0.05

Table 6 - Repeatability values for aspartame at 3 spiking levels

Aspartame	White wine (W)								
Sample	W1	W2	W3	W4	W5	W6	W7	W8	W9
Mean µg/L	34	51	45	237	231	235	981	973	982
Std. Dev.	7.3	4.2	6.7	27.5	7.6	10.9	29.0	18.0	23.2
Recovery %	68 %	101 %	91 %	95 %	92 %	94 %	98 %	97 %	98 %

OIV-MA-AS315-31: R2021

COMPENDIUM OF INTERNATIONAL METHODS OF ANALYSIS – OIV
Qualitative determination of sweeteners in wine by liquid
chromatography coupled with mass spectrometry (LC-MS)

RSDr %	21.6 %	8.3 %	14.7 %	11.6 %	3.3 %	4.6 %	3.0 %	1.8 %	2.4 %
HorRat (r)	0.87	0.33	0.59	0.59	0.17	0.24	0.19	0.12	0.15

Aspartame	Rosé wine (Ro)								
Sample	Ro1	Ro2	Ro3	Ro4	Ro5	Ro6	Ro7	Ro8	Ro9
Mean µg/L	38	42	41	200	211	210	833	905	916
Std. Dev.	3.0	2.9	4.3	6.8	5.2	5.9	20.9	34.0	22.5
Recovery %	75 %	85 %	82 %	80 %	84 %	84 %	83 %	90 %	92 %
RSDr %	8.0 %	6.9 %	10.6 %	3.4 %	2.5 %	2.8 %	2.5 %	3.8 %	2.5 %
HorRat (r)	0.32	0.28	0.43	0.17	0.13	0.14	0.16	0.24	0.15
Aspartame	Red wine (R)								
Sample	R1	R2	R3	R4	R5	R6	R7	R8	R9
Mean µg/L	46	51	50	227	254	230	956	1099	1013
Std. Dev.	8.6	3.2	8.1	16.9	10.4	7.3	21.8	39.0	20.2
Recovery %	92 %	103 %	100 %	91 %	102 %	92 %	96 %	110 %	101 %
RSDr %	18.5 %	6.3 %	16.2 %	7.4 %	4.1 %	3.2 %	2.3 %	3.5 %	2.0 %
HorRat (r)	0.74	0.25	0.65	0.38	0.21	0.16	0.14	0.22	0.13

Table 7 - Repeatability values for sodium cyclamate at 3 spiking levels

Cyclamate	White wine (W)								
Sample	W1	W2	W3	W4	W5	W6	W7	W8	W9
Mean	51	50	50	261	247	246	1092	1040	1045

OIV-MA-AS315-31: R2021

COMPENDIUM OF INTERNATIONAL METHODS OF ANALYSIS – OIV
Qualitative determination of sweeteners in wine by liquid
chromatography coupled with mass spectrometry (LC-MS)

µg/L									
Std. Dev.	1.0	1.4	1.4	2.8	4.2	3.5	12.2	17.7	14.4
Recovery %	103 %	100 %	101 %	104 %	99 %	99 %	109 %	104 %	105 %
RSDr %	1.9 %	2.9 %	2.9 %	1.1 %	1.7 %	1.4 %	1.1 %	1.7 %	1.4 %
HorRat (r)	0.08	0.12	0.11	0.05	0.09	0.07	0.07	0.11	0.09

Cyclamate	Rosé wine (Ro)								
Sample	Ro1	Ro2	Ro3	Ro4	Ro5	Ro6	Ro7	Ro8	Ro9
Mean µg/L	42	42	44	232	228	233	982	992	1002
Std. Dev.	1.6	1.3	0.8	2.8	4.4	4.5	14.9	6.0	12.9
Recovery %	84 %	85 %	88 %	93 %	91 %	93 %	98 %	99 %	100 %
RSDr %	3.9 %	3.0 %	1.7 %	1.2 %	2.0 %	1.9 %	1.5 %	0.6 %	1.3 %
HorRat (r)	0.16	0.12	0.07	0.06	0.10	0.10	0.10	0.04	0.08

Cyclamate	Red wine (R)								
Sample	R1	R2	R3	R4	R5	R6	R7	R8	R9
Mean µg/L	51	55	54	250	265	243	1069	1160	1086
Std. Dev.	1.2	1.3	1.4	5.5	5.2	4.2	27.4	13.9	18.4
Recovery %	103 %	110 %	108 %	100 %	106 %	97 %	107 %	116 %	109 %
RSDr %	2.4 %	2.4 %	2.6 %	2.2 %	2.0 %	1.7 %	2.6 %	1.2 %	1.7 %
HorRat (r)	0.10	0.10	0.10	0.11	0.10	0.09	0.16	0.08	0.11

OIV-MA-AS315-31: R2021

COMPENDIUM OF INTERNATIONAL METHODS OF ANALYSIS – OIV
Qualitative determination of sweeteners in wine by liquid
chromatography coupled with mass spectrometry (LC-MS)

Table 8 - Repeatability values for saccharin at 3 spiking levels

Saccharin	White wine (W)								
Sample	W1	W2	W3	W4	W5	W6	W7	W8	W9
Mean µg/L	45	45	59	216	214	252	920	909	1055
Std. Dev.	1.5	1.4	1.4	5.1	5.1	3.7	21.3	23.7	21.5
Recovery %	89 %	91 %	119 %	86 %	86 %	101 %	92 %	91 %	105 %
RSDr %	3.3 %	3.0 %	2.4 %	2.4 %	2.4 %	1.5 %	2.3 %	2.6 %	2.0 %
HorRat (r)	0.13	0.12	0.10	0.12	0.12	0.08	0.15	0.16	0.13

Saccharin	Rosé wine (Ro)								
Sample	Ro1	Ro2	Ro3	Ro4	Ro5	Ro6	Ro7	Ro8	Ro9
Mean µg/L	58	56	56	303	276	278	1263	1190	1204
Std. Dev.	1.4	2.0	0.6	5.5	3.5	4.8	28.8	24.8	25.2
Recovery %	116 %	112 %	112 %	121 %	110 %	111 %	126 %	119 %	120 %
RSDr %	2.4 %	3.5 %	1.1 %	1.8 %	1.3 %	1.7 %	2.3 %	2.1 %	2.1 %
HorRat (r)	0.10	0.14	0.04	0.09	0.07	0.09	0.14	0.13	0.13
Saccharin	Red wine (R)								
Sample	R1	R2	R3	R4	R5	R6	R7	R8	R9
Mean µg/L	47	44	46	224	203	199	955	906	885
Std. Dev.	1.4	0.5	1.5	4.4	2.2	2.9	20.6	20.1	25.8

OIV-MA-AS315-31: R2021

COMPENDIUM OF INTERNATIONAL METHODS OF ANALYSIS – OIV
Qualitative determination of sweeteners in wine by liquid
chromatography coupled with mass spectrometry (LC-MS)

Recovery %	94 %	88 %	92 %	89 %	81 %	80 %	95 %	91 %	88 %
RSDr %	3.0 %	1.1 %	3.2 %	2.0 %	1.1 %	1.5 %	2.2 %	2.2 %	2.9 %
HorRat (r)	0.12	0.04	0.13	0.10	0.06	0.07	0.14	0.14	0.18

Table 9 - Repeatability values for stevioside at 3 spiking levels

Stevioside	White wine (W)								
Sample	W1	W2	W3	W4	W5	W6	W7	W8	W9
Mean µg/L	41	43	30	262	265	204	1094	1116	860
Std. Dev.	0.4	0.4	0.7	2.0	31.2	1.9	13.6	12.9	6.6
Recovery %	83 %	86 %	60 %	105 %	106 %	81 %	109 %	112 %	86 %
RSDr %	1.0 %	1.0 %	2.2 %	0.8 %	11.8 %	0.9 %	1.2 %	1.2 %	0.8 %
HorRat (r)	0.04	0.04	0.09	0.04	0.60	0.05	0.08	0.07	0.05

Stevioside	Rosé wine (Ro)								
Sample	Ro1	Ro2	Ro3	Ro4	Ro5	Ro6	Ro7	Ro8	Ro9
Mean µg/L	50	39	41	237	254	286	935	1104	1109
Std. Dev.	0.8	1.3	0.9	2.6	5.3	7.1	10.5	10.2	18.3
Recovery %	99 %	77 %	81 %	95 %	102 %	114 %	93 %	110 %	111 %
RSDr %	1.7 %	3.4 %	2.2 %	1.1 %	2.1 %	2.5 %	1.1 %	0.9 %	1.6 %
HorRat (r)	0.07	0.14	0.09	0.06	0.11	0.13	0.07	0.06	0.10

COMPENDIUM OF INTERNATIONAL METHODS OF ANALYSIS – OIV
Qualitative determination of sweeteners in wine by liquid
chromatography coupled with mass spectrometry (LC-MS)

Stevioside	Red wine (R)								
Sample	R1	R2	R3	R4	R5	R6	R7	R8	R9
Mean µg/L	60	40	43	262	211	210	1048	904	921
Std. Dev.	0.9	0.7	0.4	4.0	4.0	2.6	18.0	18.4	11.9
Recovery %	120 %	80 %	86 %	105 %	85 %	84 %	105 %	90 %	92 %
RSDr %	1.5 %	1.8 %	1.0 %	1.5 %	1.9 %	1.3 %	1.7 %	2.0 %	1.3 %
HorRat (r)	0.06	0.07	0.04	0.08	0.10	0.06	0.11	0.13	0.08

Table 10 - Repeatability values for sucralose at 3 spiking levels

Sucralose	White wine (W)								
Sample	W1	W2	W3	W4	W5	W6	W7	W8	W9
Mean µg/L	53	52	53	221	225	223	986	973	1021
Std. Dev.	5.3	7.8	8.1	10.8	27.5	6.5	29.8	43.9	31.5
Recovery %	106 %	103 %	105 %	88 %	90 %	89 %	99 %	97 %	102 %
RSDr %	10.0 %	15.1 %	15.4 %	4.9 %	12.2 %	2.9 %	3.0 %	4.5 %	3.1 %
HorRat (r)	0.40	0.61	0.62	0.25	0.63	0.15	0.19	0.28	0.19
Sucralose	Rosé wine (Ro)								
Sample	Ro1	Ro2	Ro3	Ro4	Ro5	Ro6	Ro7	Ro8	Ro9

OIV-MA-AS315-31: R2021

COMPENDIUM OF INTERNATIONAL METHODS OF ANALYSIS – OIV
Qualitative determination of sweeteners in wine by liquid
chromatography coupled with mass spectrometry (LC-MS)

Mean µg/L	35	43	36	215	236	194	944	1075	905
Std. Dev.	4.1	2.1	2.2	7.2	7.4	7.7	21.3	27.5	19.3
Recovery %	70 %	86 %	71 %	86 %	94 %	78 %	94 %	108 %	91 %
RSDr %	11.7 %	5.0 %	6.2 %	3.3 %	3.1 %	4.0 %	2.3 %	2.6 %	2.1 %
HorRat (r)	0.47	0.20	0.25	0.17	0.16	0.20	0.14	0.16	0.13

Sucralose	Red wine (R)								
Sample	R1	R2	R3	R4	R5	R6	R7	R8	R9
Mean µg/L	50	46	48	236	255	228	1017	1194	1041
Std. Dev.	7.7	3.1	6.8	11.5	9.2	8.4	16.9	27.5	23.0
Recovery %	100 %	92 %	96 %	94 %	102 %	91 %	102 %	119 %	104 %
RSDr %	15.3 %	6.9 %	14.1 %	4.9 %	3.6 %	3.7 %	1.7 %	2.3 %	2.2 %
HorRat (r)	0.61	0.28	0.57	0.25	0.18	0.19	0.10	0.15	0.14

Table 11 – Repeatability summary table

Compound	Recovery	RSDr %	HorRat (r)
Acesulfame	83 % – 120 %	0.9 % – 5.0 %	0.05 – 0.20

OIV-MA-AS315-31: R2021

COMPENDIUM OF INTERNATIONAL METHODS OF ANALYSIS – OIV
Qualitative determination of sweeteners in wine by liquid
chromatography coupled with mass spectrometry (LC-MS)

Aspartame	68 % – 110 %	1.8 % – 21.6 %	0.12 – 0.87
Cyclamate	84 % – 116 %	0.6 % – 3.9 %	0.04 – 0.16
Saccharin	80 % – 126 %	1.1 % – 3.5 %	0.04 – 0.18
Stevioside	60 % – 112 %	0.8 % – 11.8 %	0.04 – 0.60
Sucralose	70 % – 119 %	1.7 % – 15.4 %	0.10 – 0.63

11.6. Intermediate Precision

Intermediate precision was evaluated by analyzing samples spiked with 50 µg/L, 250 µg/L and 1000 µg/L in different moments spanning throughout several days. The results are presented in the following tables. Count represents the number of points considered for the determination of the mean values and respective standard deviation (Std. Dev.). The recovery percentage, the relative standard deviation (RSD%) and the Horwitz ratio (HorRat) are also displayed for each case.

Table 12 – Intermediate precision values for potassium acesulfame at 3 spiking levels

Acesulfame	White wine (W)			Red (R) and Rosé wines (Ro)					
	W1	W2	W3	Ro1	Ro2	Ro3	R1	R2	R3
Sample	W1	W2	W3	Ro1	Ro2	Ro3	R1	R2	R3
Count	12	12	11	12	12	12	12	12	12
Mean µg/L	46	223	928	54	252	1089	53	252	1113
Std. Dev.	6.1	31.4	76.6	6.1	23.6	66.3	2.4	9.1	41.3
Recovery %	91 %	89 %	93 %	108 %	101 %	109 %	106 %	101 %	111 %
RSD% IP	13.2 %	14.1 %	8.2 %	11.3 %	9.4 %	6.1 %	4.5 %	3.6 %	3.7 %
HorRat	0.53	0.72	0.52	0.46	0.48	0.38	0.18	0.18	0.23

COMPENDIUM OF INTERNATIONAL METHODS OF ANALYSIS – OIV
Qualitative determination of sweeteners in wine by liquid chromatography coupled with mass spectrometry (LC-MS)

Table 13 - Intermediate precision values for aspartame at 3 spiking levels

Aspartame	White wine (W)			Rosé wine (Ro)			Red (R)		
	W1	W2	W3	Ro1	Ro2	Ro3	R1	R2	R3
Sample	W1	W2	W3	Ro1	Ro2	Ro3	R1	R2	R3
Count	11	10	10	11	12	12	11	12	12
Mean µg/L	57	281	1190	41	202	841	41	222	998
Std. Dev.	5.5	21.8	91.9	4.1	12.9	73.9	7.5	15.4	43.5
Recovery %	114 %	113 %	119 %	82 %	81 %	84 %	83 %	89 %	100 %
RSD % IP	9.6 %	7.7 %	7.7 %	10.0 %	6.4 %	8.8 %	18.1 %	6.9 %	4.4 %
HorRat	0.38	0.40	0.49	0.40	0.32	0.55	0.73	0.36	0.27

Table 14 - Intermediate precision values for sodium cyclamate at 3 spiking levels

Cyclamate	White wine (W)			Rosé wine (Ro)			Red (R)		
	W1	W2	W3	Ro1	Ro2	Ro3	R1	R2	R3
Sample	W1	W2	W3	Ro1	Ro2	Ro3	R1	R2	R3
Count	10	10	10	11	12	12	12	12	12
Mean µg/L	48	237	1011	40	210	918	49	226	999
Std. Dev.	5.5	27.3	134.3	2.5	20.1	70.7	1.3	7.4	26.6
Recovery %	97%	95%	101%	80%	84%	92%	98%	91%	100 %
RSD% IP	11.3 %	11.5 %	13.3 %	6.3 %	9.6 %	7.7 %	2.7 %	3.3 %	2.7%
HorRat	0.45	0.59	0.84	0.25	0.49	0.48	0.11	0.17	0.17

Table 15 - Intermediate precision values for saccharin at 3 spiking levels

Saccharin	White wine (W)			Red (R) and Rosé wine (Ro)					
	W1	W2	W3	Ro1	Ro2	Ro3	R1	R2	R3
Sample	W1	W2	W3	Ro1	Ro2	Ro3	R1	R2	R3
Count	11	10	10	12	12	12	12	12	12

OIV-MA-AS315-31: R2021

COMPENDIUM OF INTERNATIONAL METHODS OF ANALYSIS – OIV
Qualitative determination of sweeteners in wine by liquid
chromatography coupled with mass spectrometry (LC-MS)

Mean µg/L	51	241	1010	56	270	1166	44	195	857
Std. Dev.	2.6	8.4	36.8	2.8	10.7	47.6	3.0	8.3	31.7
Recovery %	103%	96%	101%	112%	108%	117%	88%	78%	86%
RSD % IP	5.0%	3.5%	3.6%	5.1%	4.0%	4.1%	6.9%	4.3%	3.7%
HorRat	0.20	0.18	0.23	0.20	0.20	0.26	0.28	0.22	0.23

Table 16 - Intermediate precision values for stevioside at 3 spiking levels

Stevioside	White wine (W)			Rosé wine (Ro)			Red (R)		
Sample	W1	W2	W3	Ro1	Ro2	Ro3	R1	R2	R3
Count	11	10	10	12	12	12	12	12	12
Mean µg/L	35	232	977	31	210	921	41	208	905
Std. Dev.	6.5	45.8	184.1	8.1	45.4	184.4	3.1	22.2	84.5
Recovery %	70%	93%	98%	61%	84%	92%	81%	83%	91%
RSD% IP	18.5%	19.7%	18.8%	26.4%	21.6%	20.0%	7.6%	10.7%	9.3%
HorRat	0.74	1.01	1.19	1.06	1.10	1.26	0.31	0.55	0.59

Table 17 - Intermediate precision values for sucralose at 3 spiking levels

COMPENDIUM OF INTERNATIONAL METHODS OF ANALYSIS – OIV
Qualitative determination of sweeteners in wine by liquid
chromatography coupled with mass spectrometry (LC-MS)

Sucralose	White wine (W)			Red (R) and Rosé wine (Ro)					
	W1	W2	W3	Ro1	Ro2	Ro3	R1	R2	R3
Sample	10	11	11	10	11	12	12	12	12
Count	10	11	11	10	11	12	12	12	12
Mean µg/L	51	197	776	51	295	1196	42	228	1069
Std. Dev.	10.4	41.6	137.5	11.9	48.7	184.5	5.3	18.0	51.3
Recovery %	101%	79%	78%	101%	118%	120%	85%	91%	107%
RSD % IP	20.5%	21.1%	17.7%	23.5%	16.5%	15.4%	12.5%	7.9%	4.8%
HorRat	0.82	1.08	1.12	0.94	0.84	0.97	0.50	0.40	0.30

Table 18 - Intermediate precision summary table

Compound	Recovery	RSD%	HorRat
Acesulfame	89 % – 111 %	3.6 % – 14.1 %	0.18 – 0.72
Aspartame	81 % – 119 %	4.4 % – 18.1 %	0.27 – 0.73
Cyclamate	80 % – 101 %	2.7 % – 13.3 %	0.11 – 0.84
Saccharin	78 % – 117 %	3.5 % – 6.9 %	0.18 – 0.28
Stevioside	61 % – 98 %	7.6 % – 26.4 %	0.31 – 1.26
Sucralose	78 % – 120 %	4.8 % – 23.5 %	0.30 – 1.12

12. Bibliography

EUROPEAN COMMISSION DIRECTORATE GENERAL FOR HEALTH AND FOOD SAFETY, SANTE/11813/2017, “Analytical quality control and method validation procedures for pesticide residues and analysis in food and feed”. Implemented by 01/01/2018

Horwitz W., Albert R., 2006. The Horwitz Ratio (HorRat): A Useful Index of Method Performance with Respect to Precision. J AOAC Int, 89, 1095-1109.

OIV, 2021. International Code of Oenological Practices. Issue 2021, OIV, Paris.

COMPENDIUM OF INTERNATIONAL METHODS OF ANALYSIS – OIV
Qualitative determination of sweeteners in wine by liquid
chromatography coupled with mass spectrometry (LC-MS)

Regulation (EC) No 1333/2008 of the European Parliament and of the Council of 16 December 2008 on food additives (Text with EEA relevance), 2008. OJ, L354, 16–33.

Appendix

A1. Quantitation performance for a wine sample spiked with 50 µg/L of each sweetener

OIV-MA-AS315-31: R2021

24

COMPENDIUM OF INTERNATIONAL METHODS OF ANALYSIS – OIV
Qualitative determination of sweeteners in wine by liquid
chromatography coupled with mass spectrometry (LC-MS)

Sweetener	S/N
Acesulfame K	789.4
Aspartame	586.5
Cyclamate Na	282.5
Saccharin	24.3
Sucralose	80.5
Stevioside	224.1

A2 . Sweeteners identification data - additional transitions given as guidance

Sweetener	Additional transition in ESI negative
Acesulfame K	162 > 82
Aspartame	293 > 200
Cyclamate Na	178 > 96
Saccharin	182 > 106
Sucralose	397 > 361
Stevioside	641 > 479 641 > 317

COMPENDIUM OF INTERNATIONAL ANALYSIS OF METHODS - OIV
Determination of sweeteners in white wine and white wine-
based beverages by high performance liquid chromatography
coupled with a diode array detector and a charged aerosol
detector

Method OIV-MA-AS315-32

Type IV method

Determination of sweeteners in white wine and white wine-
based beverages by high performance liquid chromatography
coupled with a diode array detector and a charged aerosol
detector

(OIV-OENO 665-2022)

1. Scope of application

This method makes it possible to determine five artificial sweeteners (acesulfame-K, aspartame, saccharine, sodium cyclamate and sucralose) in white wine (and white-wine-based beverages), within concentration ranges of up to 50 mg/L for saccharine, 125 mg/L for acesulfame-K and 250 mg/L for sucralose, sodium cyclamate and aspartame.

For greater concentrations, dilution of the sample is necessary.

Note: The presence of anthocyanins interferes with the determination of these sweeteners in rosé wine and red wines.

2. Principle

The five sweeteners are analysed by high performance liquid chromatography through separation on a C18 reverse-phase column coupled with a diode array detector and charged aerosol detector connected in series (HPLC/UV-CAD).

3. Reagents and solutions

3.1. Reagents:

3.1.1. Water compliant with EN ISO 3696 or equivalent

3.1.2. Acesulfame-K (purity \geq 99%) (CAS No. 55589-62-3)

3.1.3. Aspartame (purity \geq 98%) (CAS No. 22839-47-0)

3.1.4. Sodium cyclamate (purity \geq 98%) (CAS No. 139-05-9)

3.1.5. Saccharine sodium salt dihydrate (purity \geq 98%) (CAS No. 6155-57-3)

3.1.6. Sucralose (purity \geq 98%) (CAS No. 56038-13-2)

3.1.7. Formic acid (purity \geq 98%) (CAS No. 64-18-6)

COMPENDIUM OF INTERNATIONAL ANALYSIS OF METHODS - OIV
Determination of sweeteners in white wine and white wine-
based beverages by high performance liquid chromatography
coupled with a diode array detector and a charged aerosol
detector

3.1.8. Ammonium bicarbonate (purity \geq 98%) (CAS No. 1066-33-7)

3.1.9. HPLC-grade methanol (purity \geq 99.9%) (CAS No. 67-56-1)

3.1.10. HPLC-grade acetone (purity \geq 99.8%) (CAS No. 67-64-1)

3.2. Preparation of buffer solution

Prepare an ammonium bicarbonate (3.1.8) buffer solution at 0.4 g/L in water (3.1.1) and adjust the pH to 4.6 with formic acid (3.1.7).

This solution can be kept for 1 month at room temperature.

4. Apparatus

4.1. Everyday laboratory equipment

4.2. pH meter

4.3. Stirrer

4.4. Ultrasound bath

4.5. Analytical balance with precision of \pm 0.01 mg

4.6. Class A volumetric flasks

4.7. 0.45 μ m regenerated cellulose syringe filters (for example)

4.8. C18 HPLC column (15 cm in length, 4.6 mm in internal diameter, 5 μ m)

4.9. Chromatography system composed of:

- pump system with a minimum of three channels,
- thermostatically-controlled sampler,
- column oven,
- diode array or UV-VIS detector,
- charged aerosol detector (CAD),
- system of data acquisition, integration and calculation.

5. Procedure

5.1. Preparation of samples

- Filter the sample with syringe filters before placing it in a vial,
- if the sample is too concentrated, dilute with the buffer solution to bring the concentration within the above-specified range.

5.2. Preparation of standard solutions

5.2.1. Preparation of the stock solution, L3 (given by way of example)

COMPENDIUM OF INTERNATIONAL ANALYSIS OF METHODS - OIV
Determination of sweeteners in white wine and white wine-
based beverages by high performance liquid chromatography
coupled with a diode array detector and a charged aerosol
detector

In a 100-mL flask, add the following approximate amounts (weighed and recorded accurately):

- 12.5 mg acesulfame-K (3.1.2),
- 25 mg aspartame (3.1.3),
- 25 mg sodium cyclamate (3.1.4),
- 5 mg saccharine (3.1.5),
- 25 mg sucralose (3.1.6).

Dissolve in approx. 20 mL water/ethanol (1:1), then make up to the mark with the buffer solution. Use ultrasonic processing if necessary.

This solution, L3, can be stored for 6 months at between 2 °C and 8 °C.

5.2.2. Preparation of working solutions, L2 and L1

Prepare two other concentration levels from solution L3:

L2: solution L3 diluted to 1/2 its initial concentration. For example, add 10 mL L3 solution to a 20 mL flask and make up to volume with the buffer solution.

L1: solution L3 diluted to 2/25 its initial concentration. For example, add 2 mL L3 solution to a 25 mL flask and make up to volume with the buffer solution.

Filter the standard solutions with syringe filters and place the vials in the sampler.

Summary table of standard solutions (given by way of example):

<i>Sweeteners</i>	<i>Stock solution (Level 3)</i>			<i>Working solution (L2)</i>			<i>Working solution (L1)</i>		
	Weight (mg)	Flask volume	Concentration in mg/L	Sampled volume of L3	Flask volume	Concentration in mg/L	Sampled volume of L3	Flask volume	Concentration in mg/L
Acesulfame-K	12.5	100 mL	125	10 mL	20 mL	62.5	2 mL	25 mL	10
Aspart	25		250			125			20

COMPENDIUM OF INTERNATIONAL ANALYSIS OF METHODS - OIV
Determination of sweeteners in white wine and white wine-
based beverages by high performance liquid chromatography
coupled with a diode array detector and a charged aerosol
detector

ame									
Na cyclamate	25		250			125			20
Saccharine	5		50			25			4
Sucralose	25		250			125			20

5.3. Chromatography conditions

By way of example, the conditions used to achieve the performance described in the annex are as follows:

- Column oven temperature: 30 °C
- Sampler temperature: 20 °C
- Composition of the mobile phase (HPLC-quality reagents):
 - Phase A: 72% methanol / 25% buffer / 3% acetone
 - Phase B: 12% methanol / 88% buffer
- UV detection wavelength: 210 nm
- Flow rate: 1 mL/min
- Injection volume: 10 µL
- CAD parameters:
 - Filter: 3.6
 - Data collection rate: 10 Hz
 - Temperature: high (50 °C)
 - Power function: 0-13 min: 1.50; 13-40 min: 1.48

- Elution gradient to be applied:

Temps (min)	Percentage of A	Percentage of B
0	0%	100%
4	0%	100%
11	53%	47%

COMPENDIUM OF INTERNATIONAL ANALYSIS OF METHODS - OIV
Determination of sweeteners in white wine and white wine-
based beverages by high performance liquid chromatography
coupled with a diode array detector and a charged aerosol
detector

18.5	82%	18%
25	82%	18%
27	100%	0%
31	100%	0%
32	0%	100%
40	0%	100%

Stabilise the column for as long as necessary with mobile phase B, in addition to the CAD and DAD.

6. Calculations

The results are calculated by external calibration according to the peak area of each sweetener and expressed in mg/L, according to the calculation formula:

$$\text{Concentration of sample } \left(\frac{mg}{L} \right) = \frac{A_s - Int}{P} \times Dilution$$

Where A_s is the peak area of the sample, Int is the intercept of the calibration curve and P is the slope of the calibration curve.

7. Expression of results

For concentrations of ≤ 10 mg/L, the results can be expressed in mg/L to one significant figure after the decimal point.

For concentrations of ≥ 10 mg/L, the results can be expressed in mg/L to the nearest whole number.

8. Bibliography

COMPENDIUM OF INTERNATIONAL ANALYSIS OF METHODS - OIV

Determination of sweeteners in white wine and white wine-based beverages by high performance liquid chromatography coupled with a diode array detector and a charged aerosol detector

- International Organisation of Vine and Wine (OIV), *Compendium of International Methods of Analysis of Wines and Musts*, Vol. 1 and 2.
- NF EN 15911: Simultaneous determination of nine sweeteners by high performance liquid chromatography and evaporative light scattering detection in beverages and canned fruits.
- ISO 3696: Water for analytical laboratory use — Specification and test methods.
- ISO 11352: Water quality — Estimation of measurement uncertainty based on validation and quality control data.

Annex 1: Example chromatogram for a level 3 standard solution

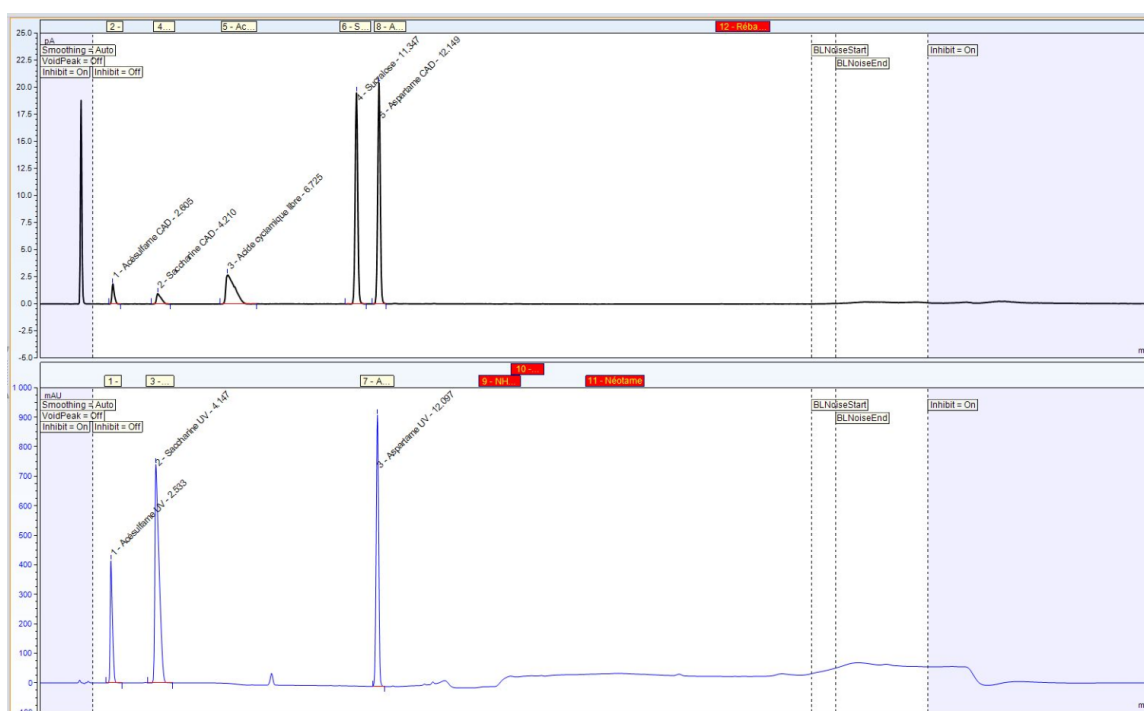

Annex 2: Example internal validation

COMPENDIUM OF INTERNATIONAL ANALYSIS OF METHODS - OIV
Determination of sweeteners in white wine and white wine-
based beverages by high performance liquid chromatography
coupled with a diode array detector and a charged aerosol
detector

The method has been the object of a performance evaluation and an internal validation study has been carried out for the white wine matrix and the white-wine-based beverage.

The method characteristics obtained as a result of this work are summarised in the following table:

Sweetener	Repeatability in % (r%)	Interlaboratory reproducibility in % (R%)	Limit of Detection applied in mg/L	Limit of Quantification applied in mg/L	Linearity range in mg/L
Acesulfame-K	2.5	8.5	2	5	5-125
Saccharine	1.7	6.8	1	2	2-50
Aspartame	1.9	8.7	4	10	10-250
Sodium Cyclamate	5.5	12.8	4	10	10-250
Sucralose	6.6	12.9	4	10	10-250

The Limit of Quantification applied corresponds to level 1; this is the first point within the calibration range.

The Limit of Detection applied corresponds to 1/3 of the Limit of Quantification.

The linearity has been verified by analysis of 5 concentration levels for each sweetener from 5 repetitions per level on different days.

The repeatability and reproductivity were obtained by analysis of each sweetener in each type of matrix on 5 different days with 2 repetitions each time, being on 3 concentration levels chosen in the linearity range of the method.

**COMPENDIUM OF INTERNATIONAL ANALYSIS OF METHODS – OIV
Quantitation of glucose, malic acid, acetic acid, fumaric acid,
shikimic acid and sorbic acid in wine using quantitative nuclear
magnetic resonance spectrometry (¹H NMR)**

Method OIV-MA-AS316-01

Type IV method

**Quantitation of glucose, malic acid, acetic acid, fumaric acid,
shikimic acid and sorbic acid in wine using quantitative nuclear
magnetic resonance spectrometry (¹H NMR)**

OIV-OENO 618-2020

1. Introduction

NMR spectroscopy is a so called primary quantitative analytical technique with broad linear ranges (5-6 orders of magnitude). Multiple suppression of water and ethanol signals can significantly increase the sensitivity for matrices containing water and ethanol (such as wine) during automated measurements. Various compounds in wine can be identified and quantified by specific signals in only one analytical run.

2. Scope

The described method is suitable for the quantitative determination of glucose, malic acid, acetic acid, fumaric acid, shikimic acid at their natural concentrations in wine and in addition for the preserving agent sorbic acid.

Working range mg/L:

Glucose	600 – 50000
Malic acid	300 – 5000
Acetic acid	30 – 2000
Fumaric acid	20 – 300
Shikimic acid	20 – 500
Sorbic acid	20 – 800

3. Abbreviations

NMR Nuclear Magnetic Resonance

¹H NMR Proton Nuclear Magnetic Resonance

COMPENDIUM OF INTERNATIONAL ANALYSIS OF METHODS – OIV
Quantitation of glucose, malic acid, acetic acid, fumaric acid,
shikimic acid and sorbic acid in wine using quantitative nuclear
magnetic resonance spectrometry (1H NMR)

TSP 3 - (trimethylsilyl) propionic acid sodium salt

PULCON PULse length based CONcentration determination

4. Principle

The wine sample is diluted with 10% buffer in D₂O. TSP is used as an internal standard to adjust the chemical shift (δ) (0 ppm). After that the sample is measured by 1H NMR. At least single water suppression has to be applied. To increase sensitivity, also suppress the signal from the ethanol. The selected wine analytes are evaluated and quantified using appropriate signals (see 11.1 Annex Table 1).

5. Reagents and materials

The reagents used and the water (5.8) must be free from the analytes to be determined. Unless otherwise stated, solution means an aqueous solution.

5.1 D₂O (99.9 atom % D) CAS 7789-20-0

5.2. 3 - (trimethylsilyl) propionic acid 2,2,3,3-d₄ sodium salt (TSP) (98 atom % D)
CAS 24493-21-8

5.3 Buffer-Solution pH 2.9 – 3.3 to adjust the pH of wine

For example: 1 M KH₂PO₄ (Potassium dihydrogen phosphate, CAS 7778-77-0, 0.1 % TSP (3 - (trimethylsilyl) propionic acid sodium salt) (5.2),

3 mM NaN₃ (sodium azide, CAS 26628-22-8) in D₂O (5.1), pH 3.10

5.4 1 M hydrochloric acid, CAS 7647-01-0

5.5 1 M sodium hydroxide, CAS 1310-73-2

5.6 Buffer solutions for the calibration of electrodes

pH 4.00 and pH 2.00 (certified Reference Material, e. g. Certipur®)

5.7 Citric acid monohydrate, CAS 5949-29-1

5.8 Agua ultrapura, ISO 3696.

COMPENDIUM OF INTERNATIONAL ANALYSIS OF METHODS – OIV
Quantitation of glucose, malic acid, acetic acid, fumaric acid,
shikimic acid and sorbic acid in wine using quantitative nuclear
magnetic resonance spectrometry (1H NMR)

6. Apparatus

The membrane filters (6.8) must be free from the analytes to be determined.

6.1 5 mm NMR tubes, max. ± 1 % inner diameter deviation

6.2 Spinner with template for adjustment of NMR tubes

6.3 Device for pH measurement (± 0.01 pH units)

6.4 Automatic titration system (adjustment of the pH to ± 0.01 pH units);
alternativ manual adjustment

6.5 NMR spectrometer, for example, 400 MHz with 5 mm probe (z-Gradient) and
temperature stabilization ± 0.2 K

6.6 100 - 1000 μ l pipettes

6.7 1.5 ml reaction vials

6.8 Polyvinylidene Fluoride (PVDF) membrane filter, 0.2 μ m pore size, 15 mm
diameter

7. Sampling

Wine samples must be clear and have to be filtered (6.8) otherwise. For the sample preparation, wines are diluted with 10% buffer in D₂O. TSP is used as an internal standard for referencing the chemical shift to δ 0 ppm. The final pH of the sample solutions should be 3.10 ± 0.02 .

For example, 900 μ l of wine is mixed with 100 μ l buffer (5.3) and the pH adjusted exactly to 3.10 (± 0.02 pH units) with hydrochloric acid (5.4) or sodium hydroxide (5.5) in order to use the quantification parameters given in 11.1 Annex Table 1. For this purpose, suitable automatic titration systems or manual adjustment with a sensitive pH meter should be used. From this mixture 600 μ l is transferred in a 5 mm NMR tube and is directly measured.

COMPENDIUM OF INTERNATIONAL ANALYSIS OF METHODS – OIV
Quantitation of glucose, malic acid, acetic acid, fumaric acid,
shikimic acid and sorbic acid in wine using quantitative nuclear
magnetic resonance spectrometry (1H NMR)

8. Procedure

8.1 NMR Spectrometer and Measurement

The measurements have to be performed with water and ethanol multipresaturation suppression schemes. Several techniques for suppressing unwanted signals, such as selective multi-presaging and watergate, are available. To properly suppress the water signal, spectrometers are equipped with appropriate pulse sequences.

The signal-to-noise ratio of the selected signals for quantification of the analytes shall be more than 10:1.

In principle, the essential parameters are as follows:

- The recycling delay has to be at least 6 sec.
- The measurements have to be performed at 300 K (27 °C) with temperature stability of ± 0.2 K without rotation.
- Resolution equal or better 16 points/Hz
- The sweep width (SW) must be equal or greater than 18 ppm.
- The calibration and measurements of wine samples must be carried out under the same pulse angle.

8.2 Quantification of compounds

The quantification is performed on the recommended signal areas/intensities of the analytes (see 11.1 Annex Table 1). It can be done by internal or external (PULCON) standardization and calibration. The signals of appropriate analytes have to be assigned (see 11.1 Annex Table 1). Pure standards in comparable concentrations have to be measured under the same conditions as samples in order to obtain the additional response correction factor for the analyte in question (e.g. by spiking experiments). Suitable signals of the target substances are listed in 11.1 Annex Table 1.

9. Calculations

9.1 Calculation with internal standard

For the quantification, appropriate signals of analytes can be evaluated according to the following formula (internal standard):

**COMPENDIUM OF INTERNATIONAL ANALYSIS OF METHODS – OIV
Quantitation of glucose, malic acid, acetic acid, fumaric acid,
shikimic acid and sorbic acid in wine using quantitative nuclear
magnetic resonance spectrometry (1H NMR)**

$$m_x = \frac{MW_x}{MW_{std}} \cdot \frac{nH_{std}}{nH_x} \cdot \frac{A_x}{A_{std}} \cdot m_{std} \cdot CF$$

m_x and m_{std}	Masses of analyte and standard [g]
MW_x and MW_{std}	Molecular weights of analyte and standard [g/mol]
nH_x and nH_{std}	Numbers of protons of analyte and standard
A_x and A_{std}	Areas for the selected peaks of analyte and standard
x	Analyte
std	Reference standard, internal standard (e.g. TSP 5.2)
CF	Correction factor – see 11.1 Annex Table 1 (if needed, obtained by spiking experiments of the analyte in question)

9.2 Calculation with external standard, PULCON method

For the quantification, appropriate signals of analytes can be evaluated according to the PULCON method by the following formula F1. For quantification an external sample with known concentration of suitable substances for calibration is used each run, Quantref sample (citric acid 20 g/L). The resulting quantification factor is part of the data of each sample. The Quantref sample is used to calculate qf according to formula F2. The PULCON method is based on the following formula:

$$F. 1 \quad \gamma_{An} = \frac{I_{An} \cdot SW_{An} \cdot M_{An} \cdot P_{An} \cdot k_{An}}{SI_{An} \cdot qf \cdot P_{Ref} \cdot N_{H,An} \cdot d_{An}^2 \cdot NS_{An}}$$

with:

γ_{An} = searched analyte mass concentration (in mg/L)

I_{An} = absolute integral of analyte in sample

SW_{An} = spectral width (e.g. 20.55 ppm)

M_{An} = molar mass of the analyte (g/mol)

P_{An} = excitation pulse length used for the sample (in μ s)

k_{An} = correction factor (if needed, obtained by spiking experiments of the analyte in question)

SI_{An} = Size (e.g. 131072)

qf = mean value quantification factor from QuantRef

**COMPENDIUM OF INTERNATIONAL ANALYSIS OF METHODS – OIV
Quantitation of glucose, malic acid, acetic acid, fumaric acid,
shikimic acid and sorbic acid in wine using quantitative nuclear
magnetic resonance spectrometry (1H NMR)**

P_{Ref} = excitation pulse length used for the QuantRef (in μs)
 $N_{H, An}$ = number of protons per analyte molecule giving this resonance
 d_{An} = inner diameter of the analyte tube
 NS_{An} = number of acquired FIDs for the analyte tube

$$F. 2 \quad qf = \frac{I_{Ref} \cdot SW_{Ref} \cdot M_{Ref}}{SI_{Ref} \cdot \gamma_{Ref} \cdot N_{H,Ref} \cdot d_{Ref}^2 \cdot NS_{Ref}} \left(\text{in } \frac{\text{a. u.} \cdot \text{ppm} \cdot \text{l}}{\text{mol}} \right)$$

With:

I_{Ref} = absolute integral of the reference signal
 SW_{Ref} = spectral width (e.g. 20.55 ppm)
 M_{Ref} = molar mass of the reference substance (g/mol)
 SI_{Ref} = size (e.g. 131072 = 128k = 2^{17})
 γ_{Ref} = mass concentration of the reference substance
 $N_{H, Ref}$ = number of protons per reference molecule giving this resonance
 d_{Ref} = inner diameter of sample tube for the reference tube
 NS_{Ref} = number of acquired FIDs for the reference tube

Furthermore, it is mandatory to acquire both reference and analyte spectra respectively with the same setting for receiver sensitivity (receiver gain). It is also advisable to keep all measurement parameters the same (temperature, the type of sample tube, SI, SW, NS) when determining qf or y_{An} respectively.

9.3 Expression of results

Results should be expressed in mg/L with one decimal for minor constituents (<1 g/L) and without decimals for major constituents (>1 g/L).

10. Precision

A ring trial was conducted to provide a realistic indication of the method performance. Details are given in Godelmann et al. 2016.

10.1 Repeatability and reproducibility

Table 1 summarizes the relative standard deviations of the repeatability and reproducibility for the different analytes (Godelmann et al. 2016).

**COMPENDIUM OF INTERNATIONAL ANALYSIS OF METHODS – OIV
Quantitation of glucose, malic acid, acetic acid, fumaric acid,
shikimic acid and sorbic acid in wine using quantitative nuclear
magnetic resonance spectrometry (1H NMR)**

Table 1: Relative standard deviations of the repeatability and reproducibility, taken from the proficiency test (Godelmann et al. 2016) for the different analytes.

	Glucose	Malic acid	Acetic acid	Fumaric acid	Shikimic acid	Sorbic acid
NMRP01 (Model wine)						
Number of laboratories	15	14	15	14	13	14
Mean mg/L	9903	2628	1056	82.1	103.6	126.1*
RSDr %	1.5	1.7	1.4	1.5	1.8	7.5
RSDR %	5.5	4.3	7.5	12.5	5	11.9
NMRP02 (white wine)						
Number of laboratories	15	14	15	14 12.1	13	15
Mean mg/L	28304	3528	868	(<LOQ)	45.8	164.6
RSDr %	1.3	1.7	1.6		4	2.1
RSDR %	4.6	14.3	9		18.3	5.1
NMRP03 (red wine)						
Number of laboratories	14	9 240	14	13	13	14
Mean mg/L	11505	(<LOQ)	544	29.1	34.6	149.7
RSDr %	2.2		3.6	3.1	14.7	2.7
RSDR %	4.3		7.6	9.1	20	5.4
NMRP04 (red wine)						
Number of laboratories	14	11	14		13	5 10.9
Mean mg/L	12538	251	627	n.d.	61.8	(<LOQ)
RSDr %	1.7	6.6	2.7		9.4	
RSDR %	3.9	11.4	5.8		15.3	
NMRP05 (white wine)						
Number of laboratories	14	13	14	13	13	15
Mean mg/L	30303	2615	1011	27.1	29.3	191.8
RSDr %	3.2	4.6	2.7	3	8.8	3.9
RSDR %	5	13.7	7	5.3	15.6	7
NMRP06 (red wine)						
Number of laboratories	14	11	14	4	12	14
Mean mg/L	6090	267	630	n.d.	30	158.5

**COMPENDIUM OF INTERNATIONAL ANALYSIS OF METHODS – OIV
Quantitation of glucose, malic acid, acetic acid, fumaric acid,
shikimic acid and sorbic acid in wine using quantitative nuclear
magnetic resonance spectrometry (1H NMR)**

RSDr %	3	6.1	2.1		9.6	4.3
RSDR %	5.3	10.2	4.9		12.6	6.3
NMRP07 (white wine)						
Number of laboratories	13	10	14	14	13	4
Mean mg/L	5297	8036	794	n.d.	36.2	3.2 (<LOQ)
RSDr %	1.5	3.7	2.6		11.5	
RSDR %	6.3	5.9	7.4		14.7	
NMRP08 (white wine)						
Number of laboratories	14	14	14	13	13	6
Mean mg/L	16518	5254	301	n.d.	68.4	5.4 (<LOQ)
RSDr %	1	2.2	3		4.2	
RSDR %	4.5	8.6	7.1		6.4	
NMRP09 (white wine)						
Number of laboratories	14	12	14	14	13	15
Mean mg/L	2091	2390	176	45.9	44.1	98
RSDr %	3.1	2.6	4.6	2.2	4.3	1.8
RSDR %	6.6	5.7	12	4.6	8.4	5.1
NMRP10 (red wine)						
Number of laboratories	9	7	14	15	13	15
Mean mg/L	442 (<LOQ)	178 (<LOQ)	502	90.6	58	200.3
RSDr %			2.4	2.5	5.2	2.9
RSDR %			11.7	7.7	16.4	6.8

10.2 Limit of detection and limit of quantification

The limit of detection (LOD) and the limit of quantification (LOQ) need to be estimated individually by the laboratories and depend on the NMR system used (particularly on the field strength). Nevertheless to give an indication the LODs and LOQs listed in Table 2 were calculated according to the instructions of the resolution OENO 7-2000 (E-AS1-10-LIMDET) on basis of sample preparation and parameters of NMR measurement previously (400 MHz, and using ethanol suppression).

Table 2: Limit of detection and limit of quantification

Analyte	LOD mg/L	LOQ mg/L
---------	----------	----------

COMPENDIUM OF INTERNATIONAL ANALYSIS OF METHODS – OIV
Quantitation of glucose, malic acid, acetic acid, fumaric acid,
shikimic acid and sorbic acid in wine using quantitative nuclear
magnetic resonance spectrometry (1H NMR)

Glucose	150	600
Malic acid	90	300
Acetic acid	10	30
Fumaric acid	5	20
Shikimic acid	5	20
Sorbic acid	5	20

COMPENDIUM OF INTERNATIONAL ANALYSIS OF METHODS – OIV

Quantitation of glucose, malic acid, acetic acid, fumaric acid, shikimic acid and sorbic acid in wine using quantitative nuclear magnetic resonance spectrometry (1H NMR)

11. Annex

11.1 Table 1 Quantification Parameters, according 400 MHz, pH 3.10

Analyte	Molarity (g/mol)	Signal used for Quantification	n of Protons	Description	Typical Region (example) ppm	Correction Factor	Comment for Correction
Malic Acid	134	H3B, 4 Signals @ approx. 2.88ppm	1	Region: Left Signal + 4.5Hz, Right Signal - 4.5Hz Local Baseline-Correction	2.8465-2.9216	1.05	Due to truncated region
Sorbic Acid	112	Half of H2, Left signal of Doublet @ approx. 5.85 ppm	0.5	Region: Left Signal of Doublet ± 7Hz Local Baseline-Correction	5.8250-5.8600	0.95	Due to roof-effect of doublet
Fumaric Acid	116	H2+H3, Singlet @ approx. 6.75 ppm	2	Region: Signal ± 3Hz Local Baseline-Correction (zero/first order)	6.7350-6.7600	1.00	-
Acetic Acid	60	H2A + H2B + H2C, Singlet @ approx. 2.07 ppm	3	Region: Signal ± 3Hz Local Baseline-Correction (zero order)	2.0720-2.0830	1.28 (combined factor)	Due to T1 (factor 1.16) and truncated region (factor 1.1)
Glucose	180	H1-alpha, Doublet @ approx. 5.21 ppm	1	Region: Center of Doublet ± 5Hz Local Baseline-Correction (zero order)	5.1900-5.2300	2.50 (combined factor)	alpha/beta-glucose (factor 2.33), truncated region (factor 1.07)
Shikimic Acid	174	H2, Higher Order (5) @ approx. 6.8 ppm	1	Region: Center of Multiplet ± 6Hz Local Baseline-Correction (zero/first order)	6.7850-6.8200	1.00	-

**COMPENDIUM OF INTERNATIONAL ANALYSIS OF METHODS – OIV
Quantitation of glucose, malic acid, acetic acid, fumaric acid, shikimic acid and
sorbic acid in wine using quantitative nuclear magnetic resonance
spectrometry (1H NMR)**

11.2 Trueness/Recovery

The recovery was determined for the ring test samples by comparing the mean values of the NMR method with respective analysis of the relevant parameter by the OIV method (for acetic acid enzymatic/HPLC methods and fumaric acid HPLC method were used)

The calculated recoveries are for glucose 100.3 % (n=9, 95.2 – 106.4), for acetic acid 108.9 % (n=10, 99.9 – 123), for malic acid 104.1 % (n=7, 91.4 – 124.1), for shikimic acid 105.2 % (n=10, 91.2 – 122.3), for sorbic acid 100.2 % (n=8, 97.9 – 102.5) and for fumaric acid 96.8 % (n=6, 80.5 – 104.1). Only for the parameter acetic acid were yielded always findings of above

100% with a total mean of 109%. For these findings, the correction factor of 1.28 could be the reason – see 11.1 Annex Table 1. The recoveries are calculated on the basis of analysis of reference values originating from OIV methods.

Table 2 Recoveries of analytes

Analyte	Mean recovery % n: number of ring test samples calculated	Variation %
Glucose	100.0 (n=9)	95.2 – 106.4
Malic acid	104.1 (n=7)	91.4 – 124.1
Acetic acid	108.9 (n=10)	99.9 – 123
Fumaric acid	96.8 (n=6)	80.5 – 104.1
Shikimic acid	105.2 (n=10)	91.2 – 122.3
Sorbic acid	100.2 (n=8)	97.9 – 102.5

11.3 Horrat values of all compounds

Table 4

Parameter	Horrat-Value			Samples
	0,5 – 1,5	1,6 – 2,0	> 2,0	
				<LOQ
Acetic Acid	7 (0,8 – 1,3)	3 (1,6; 1,6; 1,9)	0	0
Malic Acid	4 (0,9 – 1,5)	2 (1,6; 2,0)	2 (2,8; 3,1)	2
Glucose	9 (1,0 – 1,5)	0	0	1
Sorbic Acid	7 (0,6 – 1,5)	0	0	3
Fumaric Acid	6 (0,5 - 1,5)	0	0	4
Shikimic Acid	4 (0,6 – 1,3)	5 (1,6; 1,6; 1,8; 1,9; 2,0)	1 (2,1)	0

11.4 Example for an NMR spectra

Figure 1. NMR spectra of model wine with selected signals for quantification

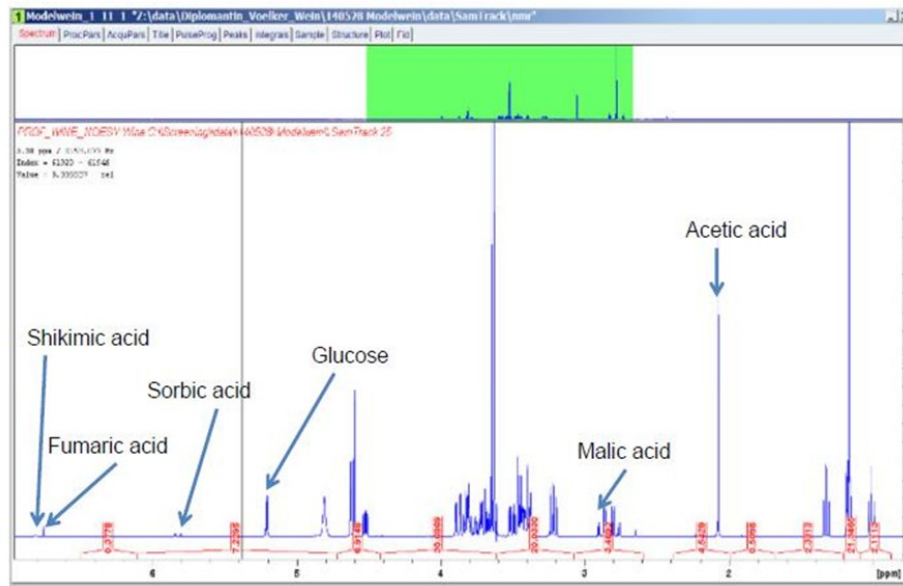

12. Literature

OIV-MA-AS316-01 : R2020

1. Godelmann R., Fang Fang, Humpfer E., Schütz B., Bansbach M., Schäfer H., Spraul M., (2013), Targeted and Nontargeted Wine Analysis by ¹H NMR Spectroscopy Combined with Multivariate Statistical Analysis. Differentiation of Important Parameters: Grape Variety, Geographical Origin, Year of Vintage, *J. Agric. Food Chem.* 61, 5610–5619
2. Monakhova Y.B., Schäfer H., Humpfer E., Spraul M., Kuballa T., Lachenmeier D., (2011), Application of automated eightfold suppression of water and ethanol signals in ¹H NMR to provide sensitivity for analyzing alcoholic beverages, *Magn. Reson. Chem.* 49,734-739
3. G. Wider, L. Dreier: Measuring Protein Concentrations by NMR Spectroscopy, *J. Am. Chem. Soc.* 2006, 128, 2571-2576
4. Godelmann R., Kost C., Patz C., Ristow R., Wachter H., (2016), Quantitation of compounds in wine using ¹H NMR spectroscopy – Description of the method and collaborative study, *Journal of AOAC International* Vol. 99, No. 5, 1295-1304
5. Horwitz W. (1995) Protocol for the design, conduct and interpretation of method- performance studies, *Pure and Applied Chemistry* 67, 331-343
6. Horwitz, W. (1982) *Anal. Chem.* 54, 67A-76A
7. Peeler, J.T., Horwitz W., & Albert R. (1989) *J. Assoc. Off. Anal. Chem.* 72, 784-806
8. Herbert-Pucheta, J.E., Mejía-Fonseca, I., Zepeda-Vallejo, L.G., Milmo-Brittingham, D., Maya, G.P. The “Wine-T1” NMR experiment of novel wine-metabolome fingerprinting with nuclear-spin relaxation DOI: 10.1051/bioconf/20191202029
9. Herbert-Pucheta, J.E., Pino-Villar, C., Rodríguez, González, F., Padilla-Mata, G., Milmo-Brittingham, D., Zepeda-Vallejo, L.G. “One-shot” analysis of wine parameters in non-Saccharomyces large-scale alcohol reduction processes with one- and two-dimensional nuclear magnetic resonance, DOI: 10.1051/bioconf/20191502016
10. Resolución OENO 7-2000 (E-AS1-10-LIMDET), “Estimación del límite de detección y de cuantificación de un método de análisis”
11. ISO 3696.

**COMPENDIUM OF INTERNATIONAL METHODS OF ANALYSIS -
OIV
Total bromide**

Method OIV-MA-AS321-01

Type IV method

**Total Bromide
(A23 revised by OIV/OENO 377/2009)**

1. Principle

The wine is ashed at 525 °C in presence of an excess of soda lime. A solution of the residue (at pH 4.65) is treated with chloramine T to liberate bromide. The bromide is reacted with phenolsulfonephthalein to form phenoltetra-bromophthalein-3'-3''-disulfonic acid, which is determined by spectrophotometer at 590 nm.

2. Apparatus

- 2.1 Boiling water-bath 100°C
- 2.2 Temperature-controlled electric furnace
- 2.3 Spectrophotometer capable of measuring absorbance at wavelengths between 300 and 700 nm

3. Reagents

- 3.1 Sodium hydroxide solution, 50% (*m/m*)
- 3.2 Calcium hydroxide suspension containing 120 g of CaO per liter
- 3.3 Phenolsulfonephthalein solution:
0.24 g of phenolsulfonephthalein (phenol red) are dissolved in 24 mL sodium hydroxide solution, 0.1 M, and made up to the liter with distilled water.
- 3.4 pH 4.65 buffer solution:
Acetic acid, 2 M 500 mL
Sodium hydroxide, 2 M 250 mL
Distilled water to 1 L
- 3.5 Oxidizing solution:
Chloramine T 2 g
Distilled water to 1 L
Prepare this solution 48 hours before use
Storage: two weeks at ± 4 °C
- 3.6 Reducing solution:
Sodium thiosulfate
25 g/L.
Distilled water to 1 L

**COMPENDIUM OF INTERNATIONAL METHODS OF ANALYSIS -
OIV**

Total bromide

- 3.7 Sulfuric acid, 10%(v/v): sulfuric acid ($r_{20} = 1.84$ g/mL) diluted 1/10.
- 3.8 Sulfuric acid, 1%(v/v): sulfuric acid ($r_{20} = 1.84$ g/mL) diluted 1/100.
- 3.9 Potassium bromide solution corresponding to 1 g of bromide per liter. 1.489g of potassium bromide, KBr, is dissolved in distilled water and made up to one liter.

4. Procedure

4.1 *How to obtain ash and ash solution*

Place 50 mL of wine in a silica dish of 7 cm diameter, add 0.5 mL 50% sodium hydroxide solution, (3.1), and 1 mL calcium hydroxide suspension (3.2). Check that the pH is at least pH 10. Leave the dish covered with a watch glass for 24 hours. Evaporate the liquid until dry on a boiling water bath. To accelerate the evaporation, a hot air current can be used in the final stages.

Ash as follows: place the dish 30 minutes in a furnace (2.2) at 525°C. After cooling, mix the residue with a little distilled water. Evaporate on the boiling water-bath. Ash again at 525°C. Repeat the operation until the ash is gray/white.

Mix the residue with 5 mL boiling distilled water. Add using a burette: first 10% sulfuric acid (3.7), then sufficient 1% sulfuric acid (3.8) to bring the pH to between 4 and 5 as measured by indicator paper. Let X mL = the volume added of sulfuric acid (3.7 & 3.8). Add 10.2-(X+5) mL of distilled water. Crush the precipitated calcium sulfate with a glass rod. Transfer the content of the dish to a centrifugation tube. Centrifuge for 10 min. Place 8 to 9 mL of the clear supernatant into a test tube.

4.2 *Qualitative test*

This test is performed to determine if the bromide content of the wine is between 0 and 1 mg/L, which would enable the determination to be performed on the undiluted ash solution.

Place in a small test tube:

- 1 mL of ash solution
- 1 drop of pH 4.65 buffer solution
- 1 drop of phenolsulfonephthalein solution
- 1 drop of chloramine T solution

After exactly 1 minute, stop the reaction by adding 1 drop of sodium thiosulfate solution.

**COMPENDIUM OF INTERNATIONAL METHODS OF ANALYSIS -
OIV**

Total bromide

If the coloration obtained is yellow, brownish yellow or greenish yellow, the ash solution can be used undiluted.

If the obtained coloration is blue, purple or violet, the wine contains more than 1 mg of bromide per liter and the ash solution must be diluted 1/12 or 1/5 until the coloration obtained corresponds to the conditions above.

4.3 Quantitative method

Place in a test tube:

- 5 mL of ash solution, diluted or undiluted, add:
- 0.25 mL of pH 4.65 buffer solution
- 0.25 mL of phenolsulfonephthalein solution
- 0.25 mL T chloramine solution

Wait exactly 1 minute and add:

- 0.25 mL of sodium thiosulfate

Measure using a spectrophotometer set at 590 nm with a 1 cm cell, the difference in absorbance between the sample and the blank obtained by adding the same quantities of reagents to 5 mL of distilled water.

Note: When the bromide content is low (yellow coloration, slightly greenish) determine the absorbance in a cell of 2 cm optical path.

4.4 Preparation of the calibration curve

At the time of use, prepare a solution containing 10 mg of bromine per liter by making 2 successive dilutions (1/10) of standard potassium bromide solution, 1 g/L.

In a set of 8 test tubes, place 0.25, 0.50, 0.75, 1.00, 1.25, 1.50, 2.00 and 2.50 mL respectively of bromide standard, 1g/L (3.9) and make up to 5 mL with distilled water. (The solutions are equivalent to 0.10, 0.20, 0.30, 0.40, 0.50, 0.60, 0.80 and 1 mg of bromine per liter of wine without dilution of the ash solution). Continue as in 4.3 using the calibration solutions instead of the ash solution. Determine the absorbance of these solutions and a blank, as in 4.3, using 5 mL of distilled water in the blank solution. The absorbance obtained corresponding to the bromide concentration is plotted on a line that curves slightly towards the origin.

5. Expression of results

5.1 Calculations

The bromide content in wine is obtained by plotting on the calibration curve, the net absorbance of the ash solution

**COMPENDIUM OF INTERNATIONAL METHODS OF ANALYSIS -
OIV**

Total bromide

(taking into account the thickness of the cell used and any dilution of the ash solution) and interpolating the bromide concentration. The total bromide content is expressed in milligrams per liter (mg/L) to two decimal places.

BIBLIOGRAPHY

DAMIENS A., *Bull. Sci. Pharmacologiques*, 1920, **27**, 609; Ibid, 1921, **28**, 37, 85 et 105.

BALANTRE P., *J. Pharm. Chem.*, 1936, **24**, 409.

PERRONET M., ROCQUES Mme S., *Ann. Fals. Fraudes*, 1952, **45**, 347.

CABANIS J.-C., *Le brome dans les vins*, Thèse doct. Pharm., Montpellier, 1962.

JAULMES P., BRUN Mme S., Cabanis J.-C., *Chim anal.*, 1962, 327.

STELLA C., *Riv. Viticolt. Enol.*, Conegliano, 1967, 5.

Chlorides

(A15 revised by OIV/OENO 377/2009)

1. Principle

Chloride is determined directly in the wine by potentiometry using an Ag/AgCl electrode.

2. Apparatus

- 2.1 pH/mV meter graduated at intervals of at least 2 mV.
- 2.2 Magnetic stirrer.
- 2.3 Ag/AgCl electrode with a saturated solution of potassium nitrate as electrolyte.
- 2.4 Microburette graduated in 0.01 mL.
- 2.5 Chronometer.

3. Reagents

- 3.1 Standard chloride solution: 2.1027 g of potassium chloride, KCl (max. 0.005% Br), dried before use, by leaving in a desiccator for several days, is dissolved in distilled water and made up to one liter. 1 mL of this solution contains 1 mg Cl⁻.
- 3.2 Silver nitrate solution: 4.7912 g of analytical grade silver nitrate, AgNO₃, is dissolved in ethanol solution, 10% (v/v) and made up to one liter. 1 mL of this solution corresponds to 1 mg Cl⁻.
- 3.3 Nitric acid, not less than 65% ($\rho_{20} = 1.40$ g/mL).

4. Procedure

- 4.1 Place 5.0 mL of standard chloride solution (3.1) into a 150 mL cylindrical vessel placed on a magnetic stirrer (2.2), dilute with distilled water to approximately 100 mL and acidify with 1.0 mL of nitric acid (3.3). After immersing the electrode, add silver nitrate solution (3.2) with the microburette, with moderate stirring using the following procedure: begin by adding the first 4 mL in 1 mL fractions and read the corresponding millivolt values. Add the next 2 mL in fractions of 0.20 mL. Finally, continue the addition in fractions of 1 mL until a total of 10 mL has been added. After each addition, wait for approximately 30 sec before reading the

**COMPENDIUM OF INTERNATIONAL METHODS OF ANALYSIS -
OIV
Chloride**

corresponding millivolt value. Plot the values obtained on a graph against the corresponding milliliters of titrant and determine the potential corresponding to the equivalence point.

- 4.2 Place 5 mL of the standard chloride solution (3.1) in a 150 mL cylindrical vessel with 95 mL of distilled water and 1 mL of nitric acid (3.3). Immerse the electrode and titrate, while stirring, until the potential of the equivalence point is obtained. This determination is repeated until a good degree of agreement in the results is obtained. This check must be carried out before each series of measurements of chloride in the samples.
- 4.3 Place 50 mL of wine into a 150 mL cylindrical vessel. Add 50 mL of distilled water and 1 mL of nitric acid (3.3) and titrate using the procedure described in 4.2.

5 Expression of results

5.1 Calculations

If n represents the number of milliliter of silver nitrate titrant, the chloride content in the tested liquid, is given by:

$20 \times n$ expressed as milligrams Cl per liter

$0.5633 \times n$ expressed as milliequivalents per liter,

$32.9 \times n$ expressed as milligrams of NaCl per liter.

- 5.2 *Repeatability (r)*: $r = 1.2$ mg Cl/L
 $r = 0.03$ mEq/L
 $r = 2.0$ mg NaCl/L

- 5.3 *Reproducibility (R)* $R = 4.1$ mg/L
 $R = 0.12$ mEq/L
 $R = 6.8$ mg NaCl/L

6. Note: For very precise determination.

Refer to the complete titration curve obtained during determination of the test liquid (4.2).

- a) Measure 50 mL of the wine to be analyzed into a 150 mL cylindrical vessel. Add 50 mL of distilled water and 1 mL of nitric acid (3.3). Titrate using silver nitrate solution (3.2), adding 0.5 mL at a time and recording the corresponding potential in millivolts. Estimate from this first titration the approximate volume of silver nitrate solution (3.2) required.
- b) Repeat the determination adding 0.5 mL of titrant at a time until the volume added is 1.5 to 2 mL less than the volume

**COMPENDIUM OF INTERNATIONAL METHODS OF ANALYSIS -
OIV
Chloride**

determined in (a). Thereafter add 0.2 mL at a time. Continue to add the solution beyond the estimated equivalence point in a symmetrical manner, i.e. by adding 0.2 mL and then 0.5 mL at a time.

The end point of the measurement and the exact volume of silver nitrate consumed are obtained:

- either by drawing the curve and determining the equivalence point;
- or by the following calculation:

$$V = V' + \Delta V_i \frac{\Delta \Delta E_1}{\Delta \Delta E_1 + \Delta \Delta E_2}$$

Where:

V = volume of titrant at the equivalence point;

V' = volume of titrant before the largest potential change;

ΔV_i = constant volume of the increments of titrant, i.e. 0.2 mL;

ΔE_1 = second difference in potential before the largest potential change;

ΔE_2 = second difference in potential after the largest potential change.

Example:

Volume of AgNO ₃ titrating solution	E potential in mV	Difference ΔE	Second difference $\Delta \Delta E$
0	204		
0.2	208	4	
0.4	212	4	0
0.6	218	6	2
0.8	224	6	0
1.0	230	6	0
1.2	238	8	2
1.4	250	12	4
1.6	272	22	10
1.8	316	44	22
2.0	350	34	10
2.2	376	26	8
2.4	396	20	6

**COMPENDIUM OF INTERNATIONAL METHODS OF ANALYSIS -
OIV
Chloride**

In this example, the end point of the titration is between 1.6 and 1.8 mL: the largest potential change ($\Delta E = 44$ mV) occurs in this interval. The volume of silver nitrate titrant consumed to measure the chlorides in the test sample is:

$$V = 1.6 + 0.2 \frac{22}{22+10} = 1.74 \text{ mL}$$

BIBLIOGRAPHY

- MIRANDA PATO C. de, *F.V., O.I.V.*, 1959, n^o12.
HUBACH C.E., *J. Ass. Off. Agric. Chem.*, 1966, **49**, 498.
Fédération internationale des Producteurs de jus de fruits, *F. O.I.V.*, 1968, n^o37.
JUNGE Ch., *F.V., O.I.V.*, 1973, n^o440.

Method OIV-MA-AS321-03

Type II method

**Determination of fluoride content in wine using a fluoride
selective ion electrode, and a standard addition method**

(A22; OENO 22/2004; OIV/OENO 377/2009)

1. SCOPE

This method is applicable to the analysis of fluoride in all wines. With proper dilution, the range of detection is 0.1 mg/l to 10.0 mg/l.

2. PRINCIPLE

The concentration of fluoride in the sample is measured after addition of a buffer, using a fluoride ion selective electrode. The buffer provides a high, constant background ionic strength; complexes iron and aluminium (which would otherwise complex with fluoride); and adjusts the pH to a level that minimises the formation of a HF•HF complex. The matrix effects are then minimised using standard addition.

3. REAGENTS

3.1 Deionized or distilled water

3.2 Sodium chloride ≥ 99.0% purity

3.3 Trisodic citrate ≥ 99.0% purity

3.4 CDTA (1,2-diaminocyclohexane-N,N,N',N'- tetracetic hydrate acid) ≥ 98.0% purity

3.5 Sodium hydroxide ≥ to 98.0% purity

3.6 Sodium hydroxide solution 32% (w/v) made from 3.5

3.7 Glacial acetic acid ≥ 99.0% purity

3.8 Sodium fluoride ≥ 99.0% purity

**COMPENDIUM OF INTERNATIONAL ANALYSIS OF METHODS -
OIV
Fluoride**

**3.9 Commercial Total Ionic Strength Adjustment Buffer (TISAB) (i.e. III-
Orion Research Inc. Cat. # 940911) or equivalent (See 4.2).**

**COMPENDIUM OF INTERNATIONAL ANALYSIS OF METHODS -
OIV
Fluoride**

3.10 Alternative TISAB:

3.10.1 To ca. 700 ml water (3.1) in a 1 l beaker (4.3), add 58.0 g \pm 0.1 g sodium chloride (3.2) and 29.4 g \pm 0.1 g of tri-sodium citrate (3.3).

3.10.2 Dissolve 10.0 g \pm 0.1 g of CDTA (1,2-diaminocyclohexane-N,N,N',N'-tetraacetic acid) (3.4) and 6 ml of 32% (w/v) sodium hydroxide (3.6) in approximately 50 ml of distilled water. (3.1)

3.10.3 Mix the two solutions together then add 57 ml of glacial acetic acid (3.7) and adjust pH to 5.5 with 32% (m/v) sodium hydroxide (3.6). Cool to room temperature, transfer to 1 l volumetric flask (4.10), and dilute to volume with water (3.1).

3.11 Fluoride standard solutions

3.11.1 Fluoride stock standard solution (100 mg/l):

Weigh 221 mg \pm 1 mg of sodium fluoride (3.8) (dried at 105°C for 4 hours) into a 1 l polyethylene volumetric flask (4.10) and make to volume with water. (3.1)

3.11.2 Fluoride calibration standards at 1.0 mg/l, 2.0 mg/l and 5.0 mg/l : make 1.0 mg/l, 2.0 mg/l, and 5.0 mg/l calibration standards by pipetting 1 ml, 2 ml, and 5 ml of the 100 mg/l stock standard (3.11.1) into three polyethylene 100 ml volumetric flasks (4.10) respectively and diluting to volume with water (3.1).

3.12 Wine blank : a wine known to be fluoride free is used as a matrix blank

3.13 1 mg/l spiked wine standard - Place 10 ml (4.11) of 100 mg/l fluoride stock standard solution(3.11.1)into a 1 l volumetric flask (4.10) and bring to volume with fluoride free wine (3.12).

**COMPENDIUM OF INTERNATIONAL ANALYSIS OF METHODS -
OIV
Fluoride**

4. APPARATUS

- 4.1 pH/ion analyser with standard addition capability (e.g. Corning pH/ion Analyser 455, Cat. # 475344) or pH/ion analyser with extended mV range.
- 4.2 Fluoride ion selective electrode and single junction reference electrode or combination electrode (e.g., Corning Fluoride Electrode Cat. # 34108-490).
- 4.3 Beakers - 150 ml, 1 l, polyethylene
- 4.4 **Cylinder** - 50 ml graduated, polyethylene, pouring.
- 4.5 Magnetic stirrer
- 4.6 Magnetic stir bars, PTFE coated.
- 4.7 Plastic bottles with caps, 125 ml (Nalgene or equivalent)
- 4.8 Precision pipette, 500 μ l
- 4.9 Ultrasonic bath
- 4.10 Volumetric flasks, Class A, 50 ml, 100 ml, and 1 l
- 4.11 Volumetric pipettes, Class A, 1 ml, 2ml, 5 ml, 10 ml, 20 ml, and 25 ml

5. PREPARATION OF CALIBRATION STANDARDS

5.1 Place 25 ml (4.11) of 1.0 mg/l, 2.0 mg/l, and 5.0 mg/l standard solutions (3.11.2) respectively into three 150 ml beakers (4.3), add 20 ml (4.11) of water (3.1) and (4.11) 5 ml of commercial TISAB (3.9) to each. Mix with a magnetic stirring. (4.5 and 4.6).

5.2 If using alternative TISAB reagent (3.10) : place 25 ml (4.11) of each standard solution (3.11.2) into three 150 ml beakers (4.3) and add 25 ml (4.11) of alternative TISAB reagent (3.10) to each. Mix with a magnetic stirrer. (4.5 and 4.6)

6. PREPARATION OF THE TEST SAMPLES

Mix the wine sample thoroughly before sampling. Sparkling wines should be degassed before sampling by transferring to a clean beaker and placing in an ultrasonic bath (4.9) until gas no longer evolves.

6.1 If using reagent (3.9), commercial TISAB : place 25 ml (4.11) of wine sample into a 150 ml beaker (4.3) with 20 ml (4.11) of water (3.1) and add 5 ml (4.11) of commercial TISAB (3.9) solution. Mix with a magnetic stirrer (4.5 and 4.6). Dilution factor (DF) = 1.

6.2 If using alternative TISAB reagent (3.10) : place 25 ml (4.11) of wine sample in a 150 ml beaker (4.3) and add 25 ml (4.11) of alternative TISAB reagent (3.10). Mix with a magnetic stirrer (4.5 and 4.6). Dilution factor (DF) = 1.

7. PROCEDURE

Measurement (all standard and wine sample solutions must be at the same temperature).

7.1 Calibration standards

Measure the potential of each of the calibration solutions, using the meter (4.1), fluoride selective electrode (4.2), and reference electrode (4.2). The final reading must be taken when the readings have stabilised (stability is obtained when the potential varies by not more than 0.2 to 0.3 mV/ 3 minutes). Record the readings for each of the calibration standards.

The \log_{10} of each of the standard concentrations versus the millivolt reading measured for each standard concentration is plotted on graph paper in order to determine the slope of the electrode.

7.2 Wine samples

Measure and record the potential expressed in mV (E1) of the sample (6.1 or 6.2) after the readings have stabilised. Add 500 μ l (4.8) of 100 mg/l fluoride standard (3.11.1) to the sample (6.1 or 6.2). After the readings have stabilised, read and record the potential expressed in mV (E2) of the wine solution.

The final concentration must be at least double the fluoride concentration in the sample solution. To make sure, if the fluoride concentration in the test sample is above 2 mg/l on the first determination, a second determination must be made after dilution of the sample as follows (7.2.1 or 7.2.2).

7.2.1 When using the commercial TISAB buffer (3.9): pipette (4.11) 25 ml of wine sample in a 50 ml volumetric flask (4.10) and bring to volume with water. Take 25 ml (4.11) of this diluted wine in a 150 ml cylindrical beaker (4.3) and add 25 ml of commercial TISAB (3.9). Mix with a magnetic stirrer (4.5 and 4.6) and then proceed with measurement as in 7.02. Dilution factor (DF) = 2.

7.2.2 When using the alternative TISAB buffer (3.9): pipette (4.11) 25 ml of wine sample in a 50 ml volumetric flask (4.10) and bring to volume with water. Pour 25 ml (4.11) of this diluted wine in a 150 ml cylindrical beaker (4.3) and add 25 ml of alternative TISAB buffer (3.10). Mix with a magnetic stirrer (4.5 and 4.6) and then proceed with measurement as in 7.2. Dilution factor: (DF) = 2.

8 CALCULATION

The fluoride content of the sample solution expressed in mg/l is obtained by using the following formula:

$$C_f = \frac{V_a \times C_a}{V_o} \times \frac{1}{((\text{anti log } \Delta E / S) - 1)}$$

If the added standard solution V_{std} is < 1% of the volume of the solution after the addition, so $V_a = V_o$ and

$$C_f = DF \times C_a \times \frac{1}{((\text{anti log } \Delta E / S) - 1)}$$

C_f = fluoride concentration of the sample solution (mg/l)

DF = dilution factor. If it is necessary to dilute the sample as in (7.2.1) or in (7.2.2), use the identical values for the dilution and the sample. That is to say, DF = 2 for a diluted sample (7.2.1) and (7.2.2) or DF = 1 if it is not as in (6.1) or (6.2)

**COMPENDIUM OF INTERNATIONAL ANALYSIS OF METHODS -
OIV
Fluoride**

V_o = initial volume of the sample solution before standard addition (ml)

V_a = volume of the solution after standard addition (ml)

ΔE = difference between potentials E1 and E2 obtained in (7.2) in mV.

S = slope of the calibration curve of the electrode.

$$C_a = \frac{V_{std} \times C_{std}}{V_{samp}}$$

where

C_a = concentration (in mg/l) of fluoride added to the sample volume (V_o) obtained by multiplying the standard volume (3.11.1) added to the solution (V_{std}) by the concentration (C_{std}) of standard (3.11.1) and divided by the sample volume (25 ml) using (6.1) or (6.2)

V_{std} = volume added standard (3.11.1) (0.5 ml)

V_{samp} = sample volume used in (6.1) or (6.2), $V_{samp} = 25$ ml

C_{std} = standard concentration (3.11.1)

Calculation example:

(1) for a sample prepared as in (6.2) and measured as in (7.2)

$DF = 1$

$$C_a = \frac{V_{std} \times C_{std}}{V_{samp}} = \frac{0.5 \text{ ml} \times 100 \text{ mg/l}}{25 \text{ ml}} = 2 \text{ mg/l}$$

$\Delta E = 19.6$ mV

$S = -58.342$

$$C_f = DF \times C_a \times \frac{1}{((\text{anti} \log \Delta E / S) - 1)}$$

$$C_f = 1 \times 2 \text{ mg/l} \times \frac{1}{((\text{anti} \log 19.6 / 58.342) - 1)}$$

$$C_f = 1 \times 2 \text{ mg/l} \times 0.856 = 1.71 \text{ mg/l of fluoride}$$

(2) for a sample prepared as in (7.2.2), and measured as in (7.2)

**COMPENDIUM OF INTERNATIONAL ANALYSIS OF METHODS -
OIV
Fluoride**

$$DF = 2$$

$$C_a = \frac{V_{std} \times C_{std}}{V_{samp}} = \frac{0.5 \text{ ml} \times 100 \text{ mg/l}}{25 \text{ ml}} = 2 \text{ mg/l}$$

$$\Delta E = 20.4 \text{ mV}$$

$$S = -55.937$$

$$C_f = DF \times C_a \times \frac{1}{((\text{anti log } \Delta E / S) - 1)}$$

$$C_f = 2 \times 2 \text{ mg/L} \times \frac{1}{((\text{anti log } 20.4 / 55.937) - 1)}$$

$$C_f = 2 \times 2 \text{ mg/l} \times 0.760 = 3.04 \text{ mg/l of fluoride}$$

9. PRECISION

The details of inter laboratory study are given in Annex B. the Horrat (Ho_R) ranges from 0.30 to 0.97 and indicates a very good reproducibility among participants.

The results of the statistical calculations are given in Annex B table 2.

The standard deviation of repeatability (RDS_r) ranges from 1.94% to 4.88%. The standard deviation of reproducibility (RDS_R) ranges from 4.15% to 18.40%. Average % recovery ranged between 99.8% and 100.3% of the mean target.

10. QUALITY ASURANCE AND MANAGEMENT

10.1 Analyse a standard solution from 1.0 mg/l (3.11.2) at the beginning and end of each series of measurement. The results must be 1.0 ± 0.1 mg/l.

10.2 Before each measurement series analyse a blank sample (3.12) and for the internal quality control (CQI) a overloaded wine (3.13). The blank sample must not be over $0.0 \text{ mg/l} \pm 0.1 \text{ mg/l}$. and the CQI must not be over $1.0 \text{ mg/l} \pm 0.2 \text{ mg/l}$.

Annex A

References

1. AOAC International, AOAC Official Methods Program, Associate Referee's Manual On Development, Study, Review, and Approval Process, 1997
2. Postel, W.; Prasz, E., Wein-Wissenschaft, (1975) 30 (6), 320-326
3. Office International de la Vigne et du Vin, Compendium of International Methods of Wine Analysis, 255-257
4. Gil Armentia, J. M.; Arranz, J. F.; Barrio, R. J.; Arranz, A., Anales de Bromatologia, (1988) 40 (1) 71-77
5. Gran, G; Analyst (1952) 77, 661
6. Corning fluoride ion selective electrode – Instruction Manual, 1994
7. Corning Instruction Manual pH/ion analyzer 455, 109121-1 Rev. A, 11/96
8. Horwitz, W.; Albert, R.; Journal of the Association of Official Analytical Chemists, (1991) 74 (5) 718

Annex B

Inter laboratory Study

VALIDATION OF A FLUORIDE ION SELECTIVE ELECTRODE,
STANDARD ADDITION METHOD FOR THE MEASUREMENT OF
FLUORIDE IN WINE

B.1 Introduction

The validation by collaborative trial of a fluoride selective ion electrode, standard addition method for the determination of fluoride in wine is described. The collaborative trial involved a total of twelve participants, six European and six Americans, who took part in the study. The collaborative study was performed using the AOAC, Youden protocol⁽¹⁾.

B2 Participants

The twelve participants of this validation consisted of laboratories from Austria, France, Germany, Spain, and the United States and comprised of the following: BATF Alcohol and Tobacco Laboratory—Alcohol Section, SF, Walnut Creek, CA., United States; BATF, National Laboratory Ctr., Rockville, MD, United States; Bundesinstitut für Gesundheitlichen Verbraucherschutz, Berlin, Germany; Canandaigua Winery, Madera, CA, United States; CIVC, Epernay, France; E. & J. Gallo Winery-Analytical Services Laboratory, Modesto, CA, United States; E. & J. Gallo Winery-Technical Analytical Services Laboratory, Modesto, CA, United States; ETS Labs, St. Helena, CA, United States; Höhere Bundeslehranstalt & Bundesamt für Wein und Obstbau, Klosterneuburg, Austria; Institut Catala de la Vinya i el Vi, Vilafranca del Penedes (Barcelona), Spain; Laboratorio Arbitral Agroalimentario, Madrid, Spain; and Sutter Home Winery, St. Helena, CA., United States.

B3 Samples used in the trial

The samples used in the trial are given in Appendix I. They were distributed as twelve wine samples (six Youden pairs of samples comprised of three red wines and three white wines).

**COMPENDIUM OF INTERNATIONAL ANALYSIS OF METHODS -
OIV
Fluoride**

<u>Sample</u>	<u>Sample description</u>
1	White wine with no fortification (total of 0.6 mg/l F ⁻)
2	White wine fortified with 0.3 mg /l (total of 0.9 mg/l F ⁻)
3	White wine fortified with 0.9 mg /l (total de 1,5 mg/l F ⁻)
4	White wine fortified with 1.2 mg /l (total de 1,8 mg/l F ⁻)
5	White wine fortified with 1.4 mg /l (total de 2,0 mg/l F ⁻)
6	White wine fortified with 1.7 mg /l (total de 2,3 mg/l F ⁻)
7	Red wine with no fortification (total de 0,2 mg/l F ⁻)
8	Red wine fortified with 0.3 mg /l (total de 0,5 mg/l F ⁻)
9	Red wine fortified with 0.8 mg /l (total de 1,0 mg/l F ⁻)
10	Red wine fortified with 1.1 mg /l (total de 1,3 mg/l F ⁻)
11	Red wine fortified with 2.5 mg /l (total de 2,7 mg/l F ⁻)
12	Red wine fortified with 2.8 mg /l (total de 3,0 mg/l F ⁻)

8.4 Results

A summary of the results obtained by the twelve participants is given in Table I. None of the laboratories reported any difficulties with the analysis. One Youden pair from one laboratory was determined to be an outlier, using the Cochran's test. These results are noted^(c) in Table I, and were not used in the statistical analysis.

**COMPENDIUM OF INTERNATIONAL ANALYSIS OF METHODS -
OIV
Fluoride**

Table 1

Collaborative data for the determination of fluoride in wine by fluoride selective electrode, standard addition^a

Lab Number	White Wine Pair 1 ^b		White Wine Pair 2 ^b		Pair 3 ^b		Pair 4 ^b		Red Wine Pair 5 ^b		Pair 6 ^b	
	1	2	3	4	5	6	7	8	9	10	11	12
1	0.55	0.80	1.33	1.56	1.86	2.24	0.19	0.45	0.89	1.17	2.54	2.77
2	0.52	0.81	1.39	1.64	1.86	2.31	0.19	0.46	0.92	1.20	2.58	2.77
3	0.52	0.81	1.40	1.70	1.92	2.25	0.14	0.42	0.96	1.22	2.64	2.95
4	0.62	0.98	1.48	1.64	1.85	2.14	0.28	0.56	1.00	1.32	2.64	2.72
5	0.48	0.78	1.34	1.64	1.84	2.11	0.12	0.39	0.88	1.16	2.56	2.82
6	0.53	0.84	1.45	1.74	1.97	2.30	0.13	0.43	0.92	1.21	2.66	2.93
7	0.53	0.76	1.27	1.64	1.89	2.06	0.14	0.40	0.88	1.12	2.44	2.83
8	0.57	0.88	1.51	1.85	2.11	2.33	0.48 ^c	0.48 ^c	1.01	1.32	2.64	3.08
9	0.51	0.81	1.40	1.71	1.90	2.20	0.13	0.42	0.90	1.19	2.60	2.86
10	0.54	0.84	1.43	1.71	1.93	2.22	0.18	0.44	0.96	1.23	2.66	2.87
11	0.60	0.93	1.48	1.75	1.98	2.32	0.25	0.57	1.06	1.31	2.68	2.82
12	0.65	0.94	1.54	1.79	2.05	2.32	0.21	0.52	1.03	1.24	2.81	3.07
N of cases	12	12	12	12	12	12	11	11	12	12	12	12
Minimum	0.48	0.76	1.27	1.56	1.84	2.06	0.12	0.39	0.88	1.12	2.44	2.72
Maximum	0.65	0.98	1.54	1.85	2.11	2.33	0.28	0.57	1.06	1.32	2.81	3.08
Range	0.17	0.22	0.27	0.29	0.27	0.27	0.16	0.18	0.18	0.20	0.37	0.36
Mean	0.55	0.85	1.42	1.70	1.93	2.23	0.18	0.46	0.95	1.22	2.62	2.87
Median	0.54	0.83	1.42	1.71	1.91	2.25	0.18	0.44	0.94	1.22	2.64	2.85
Std Dev	0.050	0.069	0.079	0.079	0.084	0.091	0.052	0.063	0.061	0.065	0.090	0.114

^a Units are mg fluoride/L.

^b Youden pairs

^c Value was deleted from data set by Cochran's Test and was not included in the statistical analysis

^c

**COMPENDIUM OF INTERNATIONAL ANALYSIS OF METHODS -
OIV
Fluoride**

Table 2

Statistical data from the collaborative study on the analysis of fluoride in wine by fluoride selective ion electrode, standard addition method

STATISTIC	White Wine			Red Wine		
	Pair 1	Pair 2	Pair 3	Pair 4	Pair 5	Pair 6
Total # of Labs	12	12	12	11 ^d	12	12
Number of "replicates" per lab	2	2	2	2	2	2
Mean (split levels)	0.55 0.85	1.42 1.70	1.93 2.23	0.18 0.46	0.95 1.22	2.62 2.87
Repeatability variance	0.0006	0.0015	0.0026	0.0002	0.0005	0.0049
Repeatability Standard Deviation	0.0235	0.0382	0.5106	0.0156	0.0211	0.0703
Relative standard deviation RSDr, repeatability	3.35 %	2.45 %	2.45 %	4.88 %	1.94 %	2.55 %
Reproducibility variance	0.0039	0.0070	0.0089	0.0034	0.0042	0.0130
Reproducibility standard deviation	0.0625	0.0835	0.0945	0.0587	0.0647	0.1141
Relative standard deviation RSDR, reproducibility	8.92 %	5.36 %	4.54 %	18.39 %	5.95 %	4.15 %
Horwitz Equation Applied (as RSDR)	16.88	14.97	14.33	19.00	15.80	13.74
HORRAT Value HoR (RSDR (measured)/RSDR (Horwitz))	0.53	0.36	0.32	0.97	0.38	0.30
Average % recovery	93.1	94.6	96.7	91.0	94.4	96.4

^d One lab pair was deleted from data set by Cochran's Test

Total Phosphorus
(A16 revised by OIV/OENO 377/2009)

1. Principle

After nitric oxidation and ashing, and dissolution in hydrochloric acid, phosphoric acid is determined colorimetrically as the yellow phospho-vanadomolybdate complex.

2. Apparatus

- 2.1 Boiling water-bath 100°C
- 2.2 Hot plate
- 2.3 Temperature-controlled electric furnace.
- 2.4 Spectrophotometer measuring absorbance at wavelengths between 300 and 700 nm

3. Reagents

- 3.1 Nitric acid, ($r_{20} = 1.39$ g/mL).
- 3.2 Hydrochloric acid, approx. 3 M; hydrochloric acid ($r_{20} = 1.15 - 1.18$ g/mL) diluted 1/4 with water.
- 3.3 Vanadomolybdate reagent:
Solution A: dissolve 40 g of ammonium molybdate, $(\text{NH}_4)_6\text{Mo}_7\text{O}_{24} \cdot 4\text{H}_2\text{O}$, in 400 mL water.
Solution B: dissolve 1 g of ammonium vanadate, NH_4VO_3 , in 300 mL water and 200 mL nitric acid ($r_{20} = 1.39$ g/L) (3.1). Leave to cool.
Vanadomolybdate reagent: place first solution B then solution A into a 1 liter flask, and make up to the mark with water. Reagent to be used within 8 days of preparation.
- 3.4 P_2O_5 solution, 0.1 g/L.
Prepare a P_2O_5 solution 1 g/L by dissolving 2.454 g of di-potassium hydrogen phosphate, K_2HPO_4 , in a liter of water. Dilute 10% (v/v).

4. Procedure

- 4.1 *Ashing*

COMPENDIUM OF INTERNATIONAL METHODS OF ANALYSIS-OIV
Total phosphorus

Place 5 mL* wine or must in a platinum or silica dish and evaporate on a boiling water-bath (2.1). When the residue is nearly dry add 1 mL nitric acid (3.1), place the dish on a hot plate (2.2) for 1 hour then in a furnace (2.3) at 600-650 °C until the ash is white.

4.2 Determination

Add 5 mL of hydrochloric acid, approximately 3 M (3.2) to the ash and transfer the solution to a 100 mL volumetric flask. Rinse the dish with 50 mL distilled water and pour the washings into the flask. Add exactly 25 mL of vanadomolybdate reagent, stir and leave for 15 to 20 min to allow the color to develop. Determine the absorbance at 400 nm.

Simultaneously, prepare standard solutions. Place in five 100 mL volumetric flasks, 5, 10, 15, 20 and 25 mL respectively of P₂O₅ solution, 0.1 g/L (3.4). Make up to 50 mL with distilled water and add 25 mL vanadomolybdate reagent. Leave for the exact same time as the samples, to allow the color to develop. Make up to the mark with water and measure the absorbance at 400 nm.

In order to remain in the best absorbance zone do not reset to zero with distilled water, but set the deviation of the spectrophotometer galvanometer on a given absorbance for a determined concentration.

5. Expression of results

5.1 Calculation

The total phosphorous content expressed in milligrams per liter of phosphoric anhydride, P₂O₅, is obtained by entering the absorbance of the wine sample on the calibration graph and interpolating the total phosphorus concentration.

The total phosphorous content is expressed in milligrams per liter P₂O₅ to the nearest whole number.

* A 5 mL sample volume is suitable for P₂O₅ content, of between 100 and 500 mg/L. Outside these concentration limits, increase or decrease the sample volume.

BIBLIOGRAPHY

A.F.N.O.R., Norme U, 42-246, Tour Europe, Paris.
SUDRAUD P., *Bull. O.I.V.*, 1969, 462-463, 933.

Sulfates

(A14, revised OIV/OENO 377/2009)

1. Principle

Gravimetric determination following precipitation of barium sulfate. The barium phosphate precipitated at the same time is eliminated by washing the precipitate in hydrochloric acid. In the case of musts or wine rich in sulfur dioxide, prior de-sulfiting by boiling in an airtight vessel is recommended.

2. Method

2.1 Reagents

2.1.1 Hydrochloric acid, 2 M.

2.1.2 Barium chloride solution, $\text{BaCl}_2 \cdot 2\text{H}_2\text{O}$, 200 g/L.

2.2 Procedure

2.2.1 General procedure:

Introduce 40 mL of the sample to be analyzed into a 50 mL centrifuge tube; add 2 mL hydrochloric acid, 2 M (2.1.1), and 2 mL of barium chloride solution, 200 g/L (2.1.2). Stir with a glass stirrer; rinse the stirrer with a little distilled water and leave to stand for five min. Centrifuge for five min, then carefully decant the supernatant liquid.

Wash the barium sulfate precipitate as follows: add 10 mL hydrochloric acid, 2 M (2.1.1), place the precipitate in suspension and centrifuge for five min, then carefully decant the supernatant liquid. Repeat the washing procedure twice as before using 15 mL distilled water each time.

Quantitatively transfer the precipitate, with distilled water, into a tared platinum capsule and place over a water bath at 100°C until fully evaporated. The dried precipitate is calcined several times briefly over a flame until a white residue is obtained. Leave to cool in a desiccator and weigh.

Let m = mass in milligrams of barium sulfate obtained.

2.2.2 Special procedure: sulfited must and wine with a high sulfur dioxide content.

**COMPENDIUM OF INTERNATIONAL METHODS OF ANALYSIS -
OIV
Sulfates**

Elimination of sulfur dioxide.

Measure 25 mL of water and 1 mL of concentrated hydrochloric acid ($r_{20} = 1.15$ to 1.18 g/mL) into a 500 mL conical flask equipped with a dropping funnel and an outlet tube. Boil the solution to remove the air and introduce 100 mL of wine through the dropping funnel. Continue boiling until the volume of liquid in the flask has been reduced to about 75 mL and quantitatively transfer, after cooling, to a 100 mL volumetric flask. Make up to mark with water. Determine the sulfate in the 40 mL sample as indicated in 2.2.1.

2.3. Expression of results

2.3.1 Calculations:

The sulfate content, expressed in milligrams per liter of potassium sulfate, K_2SO_4 is given by:

$$18.67 \times m$$

The sulfate content in musts or wine is expressed in milligrams per liter of potassium sulfate, to the nearest whole number.

2.3.2 Repeatability (r):

up to 1000 mg/L: $r = 27$ mg/L

approx. 1500 mg/L: $r = 41$ mg/L

2.3.3 Reproducibility (R):

up to 1000 mg/L: $R = 51$ mg/L

approx. 1500 mg/L: $R = 81$ mg/L

BIBLIOGRAPHY

DEIBNER L., BÉNARD P., *Ind. alim. agric.*, 1954, **71**, n^o1, 23; n^o5, 427; 1955, **72**, n^o9-10, 565 et n^o11, 673.

DEIBNER L., *Rév. ferm. ind. alim.*, 1959, **14** n^o5, 179 et n^o6, 227.

BLAREZ Ch., *Vins et spiritueux*, 1908, 149, Maloine éd., Paris.

DER HEIDE X. von, SCHITTHENNER F., *Der Wein*, 1922, 320, Vieweg & Sohn Verlag, Braunschweig.

JAULMES P., *Analyse des vins*, 1924, 73, Dubois et Poulain, éd., Montpellier; 2^e édition, 1951, 112.

**COMPENDIUM OF INTERNATIONAL METHODS OF ANALYSIS -
OIV
Sulfates**

SIMONEAU G., *Étude sur les moûts concentrés de raisins*, 1946, Thèse pharm., Montpellier, 49.
RIBÉREAU-GAYON J., PEYNAUD E., *Analyse et contrôle des vins*, 1947, 244, Ch. Béranger éd., Paris-Liège.
FROLOV-BAGREEV A., AGABALIANZ G., *Chimie du vin*, 1951, 369, Moscou, Laboratoire de chimie de l'État de Würzburg (Allemagne), *F.V.*, *O.I.V.*, 1969, no321.

Method OIV-MA-AS321-05B

Sulfates

Quick test method

Wines are classified into several categories using the so-called "limits" method, based on the precipitation of barium sulfate using a barium ion titrant.

WITHDRAWN

Ammonium
(A20 revised by OIV/OENO 377/2009)

1. Principle

Retention of the ammonium cation on a weak cation exchange resin, elution using an acidic solution, distillation of the eluent and determination of the ammonia in the distillate by titration with a standardized solution of hydrochloric acid.

2. Apparatus

2.1 Cation exchange resin column

A 50 mL burette with a glass stopcock fitted with a glass wool plug containing 25 g of weak cation exchange resin (e.g. Amberlite IR-50, 80-100 mesh).

Wash alternately with 1 M sodium hydroxide solution and 1 M hydrochloric acid solution. Wash the resin with distilled water until a negative reaction of chloride ion with silver nitrate is obtained. Pass 50 mL of neutral buffer slowly through the glass column, rinse with distilled water until phosphates begin to elute as detected using a saturated solution of lead acetate.

2.2 Distillation apparatus

Use the apparatus described in the chapter on *Alcoholic Strength 3.1*

The condensate is transferred to the conical flask through a drawn-out tube touching the bottom of the vessel.

Alternatively, it is possible to use the steam distillation apparatus used in the chapter on *Volatile Acidity 4.1* or other apparatus that can be used for the following experiments which check the purity of the reagents.

- a) Place 40-45 mL of 30 % sodium hydroxide solution (v/v), 50 mL of water and 50 mL hydrochloric acid, 1 M, in the distillation flask. Distil half the volume and collect the distillate in 30 mL of boric acid solution, 40 g/L to which 5 drops of methyl red have been added. Adjust the color to pink by the addition of 0.1 mL of 0.1 M hydrochloric acid.

**COMPENDIUM OF INTERNATIONAL METHODS OF ANALYSIS -
OIV
Ammonium**

b) A test (similar to that described in a) is conducted using, 10 mL 0.05 M ammonium sulfate solution, containing 3.55 g/L of anhydrous ammonium sulfate, (NH₄)₂SO₄. In this case, between 10 and 10.1 mL 0.1 M hydrochloric acid must be used to obtain the change of color of the indicator.

3. Reagents

3.1 Hydrochloric acid solution, 1 M.

3.2 Sodium hydroxide, 1 M.

3.3 Neutral solution to wash the resin:

<i>di</i> -sodium hydrogen phosphate Na ₂ PO ₄ .12H ₂ O	
15 g	
potassium <i>di</i> -hydrogen phosphate KH ₂ KO ₄	3.35
g	
water to	1000 mL
Verify pH is 7±0.2	

3.4 Sodium hydroxide solution, 30% (*m/m*), $r = 1.33$ g/mL

3.5 Hydrochloric acid solution, 0.1 M.

3.6 Phenolphthalein solution, 1% (*m/v*), in neutral ethanol, 96% (*V/V*)

3.7 Bromocresol green solution, 1% (*m/v*):

bromocresol green	1 g
dissolve in 0.1 M sodium hydroxide solution,	14
mL	
water to.....	100 mL

3.8 Methyl red ethanol/water solution, 0.2% (*v/v*):

methyl red	0.2 g
alcohol, 95% (<i>vol.</i>)	60 mL
water to	100 mL

3.9 Boric acid solution

Boric acid	40g
Water to	1000mL

Boric acid usually contains a small quantity of alkaline impurities and it is possible to correct this by adding 5 drops of indicator to this solution and adjusting to a pink color by means of few drops of 0.1 M hydrochloric acid (1 mL at most).

4. Procedure

**COMPENDIUM OF INTERNATIONAL METHODS OF ANALYSIS -
OIV
Ammonium**

Transfer 50 mL of the sample to be analyzed into a 250 mL beaker. Add a quantity of sodium hydroxide, 1 M, equal to half of $(n-0.5)$ mL, where n is the volume sodium hydroxide solution, 0.1 M, used in the total acidity titration on 10 mL of wine. Pass this mixture through the cation exchange column (2.1) at a rate of one drop every two seconds. The eluent pH should lie between 4 and 5. Rinse the column with 50 mL of distilled water at the same flow rate.

Ammonium and other cations are quantitatively retained on the column. Amides, oligopeptides and nearly all amino acids are eluted by the washing procedure.

Elute the cations retained on the resin with 50 mL of 1 M hydrochloric acid, (3.1) and rinse with 50 mL distilled water.* The eluate and the water washings are combined in a 1 liter round bottom distillation flask.

Add one drop of phenolphthalein, 1% (m/v), and sufficient quantity of 30% sodium hydroxide solution (m/v)(3.4), to obtain a true alkaline reaction, constantly cooling the flask during this addition.

Distil about half the volume of the liquid from the distillation flask, into 30 mL of 4% boric acid (m/v)(3.9).

The distillate is titrated with 0.1 M hydrochloric acid (3.5), in the presence of bromocresol green or methyl red. Record the volume of hydrochloric acid used (n).

5. Expression of results

The content of ammonium (NH_4) ions is expressed in milligrams per liter to the nearest whole number.

5.1 Calculation

The content of ammonium ions, expressed in milligrams per liter is:

$$36 \times n$$

When wines with low ammonium content are analyzed, the determination is conducted using 100 mL of wine. In this case the quantity of ammonium is given by:

* The column should be washed with 50 mL of neutral buffer solution and rinsed with water before using the column for another determination.

**COMPENDIUM OF INTERNATIONAL METHODS OF ANALYSIS -
OIV
Ammonium**

18 x n

BIBLIOGRAPHY

Usual Method:

JAULMES P., *Analyse des vins*, 1951, 220, Montpellier
KOURAKOU Mme S., *Ann. Fals. Exp. Chim.*, 1960, **53**, 337.

**COMPENDIUM OF INTERNATIONAL METHODS OF ANALYSIS -
OIV
Potassium**

Method OIV-MA-AS322-02A

Type II method

Potassium
(A8 revised by OIV/OENO 377/2009)

1. Principle

Potassium is determined directly in diluted wine by atomic absorption spectrophotometry after the addition of cesium chloride to suppress ionization of potassium.

2 Method

2.1 Apparatus

- Atomic absorption spectrophotometer, equipped with an air-acetylene burner
- Potassium hollow cathode lamp

2.2 Reagents

2.2.1 Solution containing 1 g of potassium per liter.

Use a standard commercial solution containing 1 g of potassium per liter. This solution may be prepared by dissolving 4.813 g of potassium hydrogen tartrate ($C_4H_5KO_6$) in distilled water and making up the volume to 1 liter with water.

2.2.2 Matrix (model) solution:

citric acid monohydrate	3.5 g
sucrose	1.5 g
glycerol	5.0 g
anhydrous calcium chloride, ($CaCl_2$)	50 mg
anhydrous magnesium chloride ($MgCl_2$)	50 mg
absolute alcohol	50 mL
water to	500 mL

2.2.3 Cesium chloride solution containing 5% cesium:

Dissolve 6.33 g of cesium chloride, $CsCl$, in 100 mL of distilled water.

2.3 Procedure

OIV-MA-AS322-02A : R2009

**COMPENDIUM OF INTERNATIONAL METHODS OF ANALYSIS -
OIV
Potassium**

2.3.1 Preparation of sample

Pipette 2.5 mL of wine (previously diluted 1/10) into a 50 mL volumetric flask, add 1 mL of the cesium chloride solution and make up to the mark with distilled water.

**COMPENDIUM OF INTERNATIONAL METHODS OF ANALYSIS -
OIV
Potassium**

2.3.2 Calibration

Introduce 5.0 mL of the matrix solution into each one of five of 100mL volumetric flasks and add 0, 2.0, 4.0, 6.0 and 8.0 mL respectively of the 1 g/L potassium solution (previously diluted 1/10). Add 2 mL of the cesium chloride solution to each flask and make up to 100 mL with distilled water.

The standard solutions contain 0, 2, 4, 6 and 8 mg of potassium per liter respectively and each contains 1 g of cesium per liter. Keep these solutions in polyethylene bottles.

2.3.3 Determination

Set the wavelength to 769.9 nm. Zero the absorbance scale using the zero standard solution (2.3.2). Aspirate the diluted wine (2.3.1) directly into the spectrophotometer, followed in succession by the standard solutions (2.3.2). Record the absorbance for each solution and repeat.

2.4 *Expression of results*

2.4.1 Method of calculation

Plot a graph showing the variation in absorbance as a function of potassium concentration in the standard solutions.

Record the mean absorbance obtained with diluted wine on this graph and determine its potassium concentration C in milligrams per liter.

The potassium concentration, expressed in milligrams per liter of the wine to the nearest whole number, is $F \times C$, where F is the dilution factor (here 200).

2.4.2 Repeatability (*r*): $r = 35 \text{ mg/L}$.

2.4.3 Reproducibility (*R*): $R = 66 \text{ mg/L}$.

2.4.4 Other ways of expressing results

- In milliequivalents per liter: $0.0256 \times F \times C$.
- In mg potassium hydrogen tartrate per liter: $4.813 \times F \times C$.

**COMPENDIUM OF INTERNATIONAL METHODS OF ANALYSIS -
OIV
Potassium**

Method OIV-MA-AS322-02B

Type III method

Potassium

(A8; revised by OIV/OENO 377/2009)

1. Principle

Potassium is determined directly in diluted wine by flame photometry.

Note: The gravimetric determination of potassium tetraphenylborate precipitated from the solution of the ash of wine is a precise method for the determination of potassium and is described in the annex.

2. Method

2.1 Apparatus

2.1.1 Flame photometer supplied with an air-butane mixture.

2.2 Reagents

2.2.1 Reference solution containing 100 mg potassium per liter

Absolute alcohol	10 mL
Citric acid C ₆ H ₈ O ₇ , H ₂ O	700 mg
Sucrose	300 mg
Glycerol	1000 mg
Sodium chloride, NaCl	50.8 mg
Anhydrous calcium chloride, CaCl ₂	10 mg
Anhydrous potassium hydrogen tartrate	481.3 mg
water to	1000 mL

Dissolve the potassium hydrogen tartrate in 500 mL of very hot distilled water, mix this solution with 400 mL of distilled water in which the other chemicals have already been dissolved, and make up to one liter.

2.2.2 Dilution solution

Absolute alcohol	10 mL
Citric acid anhydrous	700 mg

**COMPENDIUM OF INTERNATIONAL METHODS OF ANALYSIS -
OIV
Potassium**

Sucrose	300 mg
Glycerol	1000 mg
Sodium chloride, NaCl	50.8 mg
Anhydrous calcium chloride, CaCl ₂	
10 mg	
Anhydrous magnesium chloride, MgCl ₂	
	10 mg
Tartaric acid	383 mg
Water to	1000 mL

Preserve the solutions in polyethylene bottles by adding two drops of allyl isothiocyanate (3-isothiocyanato-1-propene; CH₂=CHCH₂NCS).

2.3 Procedure

2.3.1 Calibration

Place 25, 50, 75 and 100 mL of the reference solution into a set of four 100 mL volumetric flasks and make up to 100 mL with the dilution solution to give solutions containing 25, 50, 75 and 100 mg of potassium per liter respectively.

2.3.2 Determination

Make measurements at 766 nm. and adjust the 100% transmission using distilled water. Successively aspirate the standard solutions directly into the burner of the photometer, followed by wine diluted 1/10 with distilled water and note the readings. If necessary, the wine already diluted ¹/₁₀ may be further diluted with the dilution solution (2.2.2).

2.4 Expression of results

2.4.1 Method of calculation

Plot a graph of the variation in percentage transmission as a function of the potassium concentration in the standard solutions. Record the transmission obtained for the sample of diluted wine on this graph and determine the corresponding potassium concentration C.

The potassium concentration in mg potassium per liter to the nearest whole number will be:

**COMPENDIUM OF INTERNATIONAL METHODS OF ANALYSIS -
OIV
Potassium**

$$F \times C$$

where F is the dilution factor.

2.4.2 Repeatability (*r*): $r = 17 \text{ mg/L}$.

2.4.3 Reproducibility (R): $R = 66 \text{ mg/L}$.

2.4.4 Other ways of expressing results:

- In milliequivalents per liter: $0.0256 \times F \times C$.
- In mg potassium hydrogen tartrate per liter $4.813 \times F \times C$.

Method OIV-MA-AS322-02C

Potassium

(A8; OIV/OENO 377/2009)

**Gravimetric determination of potassium using sodium
tetraphenylborate**

WITHDRAWN

Sodium

(A8 revised by OIV/OENO 377/2009)

1. Principle

Sodium is determined directly in the wine by atomic absorption spectrophotometry after the addition of cesium chloride to suppress ionization of sodium.

2. Method

2.1 Apparatus

- Atomic absorption spectrophotometer equipped with an air-acetylene burner.
- Sodium hollow cathode lamp.

2.2 Reagents

2.2.1 Solution containing 1 g of sodium per liter:

The use of a commercial standard solution containing 1 g of sodium per liter is preferred.

Alternatively, this solution may be prepared by dissolving 2.542 g of anhydrous sodium chloride (NaCl) in distilled water and making up to a volume of 1 liter.

Keep this solution in a polyethylene bottle.

2.2.2 Matrix (model) solution:

Citric acid monohydrate, (C ₆ H ₈ O ₇ .H ₂ O)	3.5 g
Sucrose	1.5 g
Glycerol	5.0 g
Anhydrous calcium chloride (CaCl ₂)	50 mg
Anhydrous magnesium chloride, (MgCl ₂)	50 mg
Absolute alcohol	50 mL
De-ionized water to	500 mL

2.2.3 Cesium chloride solution containing 5% cesium

Dissolve 6.330 g of cesium chloride, CsCl, in 100 mL of distilled water.

**COMPENDIUM OF INTERNATIONAL METHODS OF ANALYSIS -
OIV
Sodium**

2.3 Procedure

2.3.1 Preparation of the sample

Pipette 2.5 mL of wine into a 50 mL volumetric flask, add 1 mL of the cesium chloride solution (2.2.3) and make up to the mark with distilled water.

2.3.2 Calibration

Place 5.0 mL of the matrix solution in each one of five 100 mL volumetric flasks and add 0, 2.5, 5.0, 7.5 and 10 mL respectively of a 1:100 dilution of the 1 g/L sodium solution. Add 2 mL of the cesium chloride solution (2.2.3) to each flask and make up to 100 mL with distilled water.

The standard solutions prepared in this way contain 0.25, 0.50, 0.75 and 1.00 mg of sodium per liter respectively and each contains 1 g of cesium per liter. Keep these solutions in polyethylene bottles.

2.3.3 Determination

Set the absorbance wavelength to 589.0 nm. Zero the absorbance scale using the zero standard solution. Aspirate the diluted wine (2.3.1) directly into the spectrophotometer, followed in succession by the standard solutions (2.3.2). Record each absorbance and repeat each measurement.

2.4 Expression of results

2.4.1 Method of calculation

Plot a graph of measured absorbance versus the sodium concentration in the standard solutions.

Record the absorbance obtained with the diluted wine on this graph and determine its sodium concentration *C* in milligrams per liter.

The sodium concentration in milligrams per liter of the wine will then be $F \times C$, expressed to the nearest whole number, where *F* is the dilution factor.

2.4.2. Repeatability (*r*): $r = 1 + 0.024 x_j$
mg/L.

x_j = concentration of sodium in the sample in mg/L.

2.4.3. Reproducibility (*R*): $R = 2.5 + 0.05 x_j$ mg/L.

x_j = concentration of sodium in the sample in mg/L.

**COMPENDIUM OF INTERNATIONAL METHODS OF ANALYSIS -
OIV
Sodium**

Method OIV-MA-AS322-03B

Type III method

Sodium
(A25 revised by OIV/OENO 377/2009)

1. Principle

Sodium is determined directly in diluted wine (at least 1 mL:10 mL) by flame photometry.

2. Method

2.1 Apparatus

2.1.1. Flame photometer supplied with an air-butane mixture.

2.2 Reagents

2.2.1 Reference solution containing 20 mg sodium per liter

Absolute alcohol	10 mL
Citric acid monohydrate (C ₆ H ₈ O ₇ · H ₂ O)	7 00 mg
Sucrose	300 mg
Glycerol	1000 mg
Potassium hydrogen tartrate	481.3 mg
Anhydrous calcium chloride, CaCl ₂	10 mg
Anhydrous magnesium chloride, MgCl ₂	10 mg
Dry sodium chloride, NaCl	50.84 mg
Water to	1000 mL

2.2.2 Dilution solution

Absolute alcohol	10 mL
Citric acid monohydrate (C ₆ H ₈ O ₇ · H ₂ O)	700 mg
Sucrose	300 mg
Glycerol	1000 mg
Potassium hydrogen tartrate	481.3 mg
Anhydrous calcium chloride, CaCl ₂	10 mg

**COMPENDIUM OF INTERNATIONAL METHODS OF ANALYSIS -
OIV
Sodium**

Anhydrous magnesium chloride, MgCl₂ 10
mg
Water to 1000 mL

To prepare 2.2.1 and 2.2.2, dissolve the potassium hydrogen tartrate in approximately 500 mL of very hot distilled water, mix with 400 mL of distilled water into which the other chemicals have already been dissolved, and make up to one liter.

Preserve the solutions in polyethylene bottles by adding two drops of allyl isothiocyanate to each.

2.3 Procedure

2.3.1 Calibration

Place 5, 10, 15, 20 and 25 mL of the reference solution in each of five 100 mL volumetric flasks and make up to 100 mL with the dilution solution to give solutions containing 1, 2, 3, 4 and 5 mg of sodium per liter respectively.

2.3.2 Determination

Carry out measurements at 589.0 nm and adjust the 100% transmission using distilled water. Successively aspirate the standard solutions directly into the photometer, followed by the wine diluted 1:10 with distilled water and note the percentage transmission of each. If necessary, the wine already diluted 1:10 may be further diluted with dilution solution.

2.4 Expression of results

2.4.1 Calculation method

Plot a graph of the percentage transmittance versus sodium concentration of the standard solutions. Record the transmission obtained for the diluted wine sample on this graph and note the concentration, C, of sodium in the wine.

The sodium concentration in mg of sodium per liter will be:

$$F \times C$$

where F is the dilution factor.

2.4.2 Repeatability (r)

r = 1.4 mg/L (except for liqueur wine)

**COMPENDIUM OF INTERNATIONAL METHODS OF ANALYSIS -
OIV
Sodium**

$r = 2.0$ mg/L for liqueur wine.

2.4.3. Reproducibility (R)

$$R = 4.7 + 0.08 x_j \text{ mg/L.}$$

x_j = sodium concentration in the sample in mg/L.

Calcium
(A26 revised by OIV/OENO 377/2009)

1. Principle

Calcium is determined directly on diluted wine by atomic absorption spectrophotometry after the addition of an ionization suppression agent.

2. Apparatus

2.1 Atomic absorption spectrophotometer fitted with an air-acetylene burner.

2.2 Calcium hollow cathode lamp.

3. Reagents

3.1 Calcium standard solution 1 g/L. Use of a standard commercial calcium solution, 1 g/L, is preferred.

Alternatively this solution may be prepared by dissolving 2.5 g of calcium carbonate, CaCO_3 , in sufficient hydrochloric acid (concentrated hydrochloric acid diluted 1:10) to dissolve it completely and making up to one liter with distilled water.

3.2 Dilute calcium standard solution, 50 mg/L

Note : Store the calcium solutions in polyethylene containers.

3.3 Dilute lanthanum standard solution, 50 g/L

Dissolve 13.369 g of lanthanum chloride, $\text{LaCl}_3 \cdot 7\text{H}_2\text{O}$ in distilled water; add 1 mL of dilute hydrochloric acid (concentrated hydrochloric acid diluted 1/10) and make up to 100 mL with distilled water.

4. Procedure

4.1 *Preparation of sample*

Place 1 mL of wine and 2 mL of the lanthanum chloride solution (3.3) in a 20 mL volumetric flask and make up to the mark with distilled water. The diluted wine contains 5 g lanthanum per liter.

Note: For sweet wines, 5 g lanthanum per liter is sufficient provided that the dilution reduces the sugar content to less

**COMPENDIUM OF INTERNATIONAL METHODS OF ANALYSIS -
OIV
Calcium**

than 2.5 g/L. For wines with higher concentrations of sugar, the lanthanum concentration should be increased to 10 g/L.

4.2 Calibration

Place 0, 5, 10, 15 and 20 mL, of dilute standard calcium solution (3.2) respectively into each of five 100 mL volumetric flasks, followed by 10 mL of the lanthanum chloride solution (3.3) and make up to 100 mL with distilled water. The solutions prepared in this way contain 0, 2.5, 5.0, 7.5 and 10 mg of calcium per liter respectively, and each contains 5 g of lanthanum per liter. These solutions should be stored in polyethylene bottles.

4.3 Determination

Set the absorbance wavelength to 422.7 nm. Zero the absorbance scale using the zero standard (4.2). Aspirate the diluted wine directly into the spectrophotometer, followed in succession by the five standard solutions (4.2) and record the absorbance. Repeat each measurement.

5. Expression of results

5.1 Method of calculation

Plot a graph showing the variation in absorbance as a function of the calcium concentration in the standard solutions.

Record the mean value of the absorbance obtained with the sample of diluted wine on this graph and read its calcium concentration C. The calcium concentration in milligrams per liter of the wine to the nearest whole number is given by:

$$20 \times C.$$

5.2 Repeatability (r)

Concentration < 60 mg/L: $r = 2.7 \text{ mg/L}$.

Concentration > 60 mg/L: $r = 4 \text{ mg/L}$.

5.3 Reproducibility (R)

$$R \text{ mg/L} = 0.114 x_i - 0.5.$$

where x_i = concentration in the sample in mg/L.

Method OIV-MA-AS322-05A

Type IV method

Iron

(A9 revised by OIV/OENO 377/2009)

1. Principle

After suitable dilution of the wine and removal of alcohol, iron is determined directly by atomic absorption spectrophotometry.

2. Method

2.1 Apparatus

- 2.1.1 Rotary evaporator with thermostatically controlled water bath.
- 2.1.2 Atomic absorption spectrophotometer equipped with an air-acetylene burner.
- 2.1.3 Iron hollow cathode lamp.

2.2 Reagents

- 2.2.1 Concentrated standard iron solution containing 1 g Fe (III) per liter.
Use a standard commercial solution, 1 g/L. This solution may be prepared by dissolving 8.6341 g of ferric ammonium sulfate, $\text{FeNH}_4(\text{SO}_4)_2 \cdot 12\text{H}_2\text{O}$, in distilled water slightly acidified with hydrochloric acid, 1 M, and making up to one liter.
- 2.2.2 Dilute standard iron solution containing 100 mg iron per liter.

2.3 Procedure

2.3.1 *Preparation of sample*

Remove the alcohol from the wine by reducing the volume of the sample to half its original size using a rotary evaporator (50 to 60 °C). Make up to the original volume with distilled water.

If necessary, dilute prior to analysis with distilled water.

2.3.2 *Calibration*

Place 1, 2, 3, 4 and 5 mL of the solution containing 100 mg iron per liter (2.2.2) respectively into each of five 100 mL volumetric flasks and make up to 100 mL with distilled water. The solutions prepared in this way contain 1, 2, 3, 4 and 5 mg of iron per liter respectively. These solutions should be stored in polyethylene bottles.

2.3.3 *Determination*

Set the absorption wavelength to 248.3 nm. Zero the absorbance scale using distilled water. Aspirate the diluted sample directly into the spectrophotometer,

**COMPENDIUM OF INTERNATIONAL METHODS OF ANALYSIS -
OIV
Iron**

followed in succession by the five standards (2.3.2). Record the absorbance. Repeat each measurement.

2.4 Expression of results

2.4.1 Method of calculation

Plot a graph giving the variation in absorbance as a function of the iron concentration in the standard solutions. Record the mean value of the absorbance obtained with the diluted wine sample on this graph and read its iron concentration C.

The iron concentration in milligrams per liter of the wine to one decimal place is given by:

$$F \times C$$

where F is the dilution factor.

Iron

(A9 revised by OIV/OENO 377/2009)

1. Principle

After digestion in hydrogen peroxide, 30%, the total iron, present as Fe (III) state, is reduced to the Fe (II) and quantified by the formation of a colored *ortho*-phenanthroline complex.

2. Method

2.1 Apparatus

2.1.1 Kjeldahl flask, 100 mL.

2.1.2 Spectrophotometer enabling measurements to be made at a wavelength of 508 nm.

2.2 Reagents

2.2.1 Hydrogen peroxide, H₂O₂, 30% (*m/v*), solution, iron free.

2.2.2 Hydrochloric acid, 1 M, iron free.

2.2.3 Ammonium hydroxide ($\rho_{20} = 0.92$ g/mL).

2.2.4 Pumice stone grains, pretreated with boiling hydrochloric acid_diluted 1/2 and washed with distilled water.

2.2.5 Hydroquinone solution, C₆H₆O₂, 2.5%, acidified with 1 mL concentrated sulfuric acid ($\rho_{20} = 1.84$ g/mL) per 100 mL of solution. This solution must be kept in an amber bottle in the refrigerator and discarded at the slightest sign of darkening.

2.2.6 Sodium sulfite solution, Na₂S₂O₃, 20%, prepared from neutral anhydrous sodium sulfite.

2.2.7 *ortho*-phenanthroline solution, C₁₂H₈N₂, 0.5%, in alcohol, 96% vol.

2.2.8 Ammonium acetate solution, CH₃COONH₄, 20% (*m/v*).

2.2.9 Fe (III) solution containing 1 g of iron per liter. Use of a commercial solution is preferred. Alternatively, a 1000 mg/L Fe (III) solution can be prepared by dissolving 8.6341 g of ferric ammonium sulfate, FeNH₄(SO₄)₂.12H₂O, in 100 mL of hydrochloric acid, 1 M, and making up the volume to one liter with the hydrochloric acid, 1 M.

**COMPENDIUM OF INTERNATIONAL METHODS OF ANALYSIS -
OIV
Iron**

2.2.10 Dilute standard iron solution containing 100 milligrams of iron per liter.

2.3 Procedure

2.3.1 Digestion

2.3.1.1 For wines with sugar content below 50 g/L

Combine 25 mL of the wine, 10 mL of the hydrogen peroxide solution and a few grains of pumice into the 100 mL Kjeldahl flask. Concentrate the mixture to a volume of 2 to 3 mL by heating. Allow to cool and add sufficient ammonium hydroxide to make the residue alkaline thus precipitating hydroxides while taking care not to wet the walls of the flask.

After cooling, carefully add hydrochloric acid, to the alkaline liquid to dissolve the precipitated hydroxides and transfer the resulting solution to a 100 mL volumetric flask. Rinse the Kjeldahl flask with hydrochloric acid, and combined the solutions in the volumetric flask and make up to 100 mL.

2.3.1.2 For musts and wines with sugar content above 50 g/L

- If the sugar content is between 50 and 200 g/L, the 25 mL wine sample is treated with 20 mL of hydrogen peroxide solution. Continue as in 2.3.1.1.
- If the sugar content is greater than 200 g/L, the samples of wine or must should be diluted 1/2 or possibly 1/4 before being treated with 20 mL of hydrogen peroxide solution. Continue as in 2.3.1.1.

2.3.2 Blank experiment

Carry out a blank trial with distilled water using the same volume of hydrogen peroxide solution as the amount used for the mineralization, following the experimental protocol described in 2.3.1.1.

2.3.3 Determination

Introduce 20 mL of the hydrochloric acid wine digest solution and 20 mL, of the hydrochloric acid solution obtained from the 'blank experiment' into two separate 50 mL volumetric flasks. Add 2 mL of hydroquinone solution, 2 mL of sulfite solution and 1 mL of *ortho*-phenanthroline. Allow to stand for 15 minutes, during which time Fe (III) is reduced to Fe (II). Then add 10 mL of ammonium acetate solution, make each up to 50 mL with distilled water and shake the two volumetric flasks. Use the solution originating from the blank experiment to zero the absorbance scale at 508 nm and measure the absorbance of the wine solution at the same wavelength.

2.3.4 Calibration

Place 0.5, 1, 1.5 and 2 mL of the 100 mg of iron per liter solution into each of four 50 mL volumetric flasks, and add 20 mL of distilled water to each. Carry out the procedure described in 2.3.3 to measure the absorbance of each of these

**COMPENDIUM OF INTERNATIONAL METHODS OF ANALYSIS -
OIV
Iron**

standard solutions, which contain 50, 100, 150 and 200 micrograms of iron respectively.

2.4 *Expression of results*

2.4.1 Method of calculation

Plot a graph giving the variation in absorbance as a function of the iron concentration in the standard solutions. Record the absorbance of the test solution and read off the iron concentration *C* in the hydrochloric acid digestion solution, i.e. in 5 mL of the wine being analyzed.

The iron concentration in milligrams per liter of the wine to one decimal place is given by:

$$200 \times C$$

If the wine (or must) has been diluted, the iron concentration in milligrams per liter of the wine to one decimal place is given by:

$$200 \times F \times C$$

where *F* is the dilution factor.

Copper

(Recueil OIV ed. 1990 revised by OIV/OENO 377/2009)

1. Principle

The method is based on the use of atomic absorption spectrophotometry.

2. Apparatus

- 2.1 Platinum dish.
- 2.2 Atomic absorption spectrophotometer.
- 2.3 Copper hollow cathode lamp.
- 2.4 Gas supplies: air-acetylene or nitrous oxide/acetylene.

3. Reagents

- 3.1 Metallic copper.
- 3.2 Nitric acid ($\rho_{20} = 1.38$ g/mL), 65%.
- 3.3 Nitric acid (3.2), diluted 1/2 (v/v) with water.
- 3.4 Solution containing 1g of copper per L.
Use of a standard commercial copper solution is preferred. Alternatively this solution may be prepared by weighing 1.000 g of metallic copper and transferring it without loss to a 1000 mL volumetric flask. Add just enough dilute nitric acid to dissolve the metal, add 10 mL of concentrated nitric acid and make up to the mark with double distilled water.
- 3.5 Solution containing copper at 100 mg/L
Transfer 10 mL, of the 1 g/L solution 3.4. into a 100 mL volumetric flask, and make up to the mark with double-distilled water.
- 3.6 Double-distilled water

4. Procedure

- 4.1 *Preparation of sample and determination of copper*

**COMPENDIUM OF INTERNATIONAL METHODS OF ANALYSIS -
OIV
Copper**

Place 20 mL sample in a 100 mL volumetric flask and make up to 100 mL with double-distilled water. Modify the dilution if necessary to obtain a response within the dynamic range of the detector.

Measure the absorbance at 324.8 nm. Set the zero with double distilled water.

4.2 Constructing a standard curve

Pipette 0.5, 1 and 2 mL of copper solution into each of three 100 mL volumetric flasks and make to the volume with double distilled water; the solutions contain 0.5, 1 and 2 mg of copper per liter respectively. Measure the absorbance of standard solutions and the sample prepared in and repeat each measurement. Plot a graph showing the variation in absorbance as a function of the copper concentration in the standard solutions.

5 Expression of results

5.1 Method of calculation

Using the measured absorbance of the samples read off the concentration C in mg/L from the calibration curve.

If F is the dilution factor, the concentration of the copper present is given in milligrams per liter by:

$$F \times C.$$

It is quoted to two decimal places.

Notes:

- a) Select a sample dilution appropriate to the sensitivity of the apparatus to be used and the concentration of the copper present in the sample.
- b) Proceed as follows when very low copper concentrations are expected in the sample to be analyzed: Place 100 mL of the sample in a platinum dish and evaporate on a water bath at 100 °C until it becomes syrupy. Add 2.5 mL of concentrated nitric acid drop wise, covering the bottom of the dish completely. Carefully ash the residue on an electric hotplate or over a low flame; then place the dish in a muffle furnace set at 500° ± 25°C and leave for about one hour. After cooling, moisten the ash with 1 mL of concentrated nitric acid while crushing it with a glass rod; allow the mixture to evaporate and

**COMPENDIUM OF INTERNATIONAL METHODS OF ANALYSIS -
OIV
Copper**

ash again as before. Place the dish in the muffle furnace again for 15 min; repeat the treatment with nitric acid at least three times. Dissolve the ash by adding 1 mL of concentrated nitric acid and 2 mL of double distilled water to the dish and transfer to a 10 mL flask. Wash the dish three times using 2 mL of double distilled water each time. Finally, make to volume with double distilled water. Proceed to analyze the sample as in 4.1 but use 10 mL of solution. Take into account the change in dilution factor when calculating the results.

Magnesium

1. Principle

Magnesium is determined directly on diluted wine by atomic absorption spectrophotometry.

2. Apparatus

2.1 Atomic absorption spectrophotometer fitted with an air-acetylene burner.

2.2 Magnesium hollow cathode lamp.

3. Reagents

3.1 Concentrated magnesium standard solution containing 1 g/L

Use of a standard commercial magnesium solution (1 g/L) is preferred.

Alternatively, this solution may be prepared by dissolving 8.3646 g of magnesium chloride, $MgCl_2 \cdot 6H_2O$, in distilled water and making up to 1 liter.

3.2 Dilute magnesium standard solution, 5 mg/L.

Note: Keep the standard magnesium solutions in polyethylene bottles.

4. Procedure

4.1 *Preparation of sample*

The wine is diluted 1/100 with distilled water.

4.2 *Calibration*

Place 5, 10, 15 and 20 mL of the dilute standard magnesium solution into each one of a set of four 100 mL volumetric flasks and make up to 100 mL with distilled water. The standard solutions prepared in this way contain 0.25, 0.50, 0.75 and 1.0 mg of magnesium per liter respectively. These solutions should be kept in polyethylene bottles.

**COMPENDIUM OF INTERNATIONAL METHODS OF ANALYSIS -
OIV
Magnesium**

4.3 Determination

Set the absorption wavelength to 285 nm. Zero the absorbance scale using distilled water. Aspirate the diluted wine directly into the spectrophotometer, followed in succession by the standard solutions (4.2).

Record the absorbance of each solution and repeat each measurement.

5. Expression of results

5.1 Method of calculation

Plot a graph showing the variation in absorbance as a function of the magnesium concentration in the standard solutions.

Record the mean value of absorbance with the diluted sample of wine on this graph and read off the magnesium concentration *C* in milligrams per liter. The magnesium concentration in milligrams per liter of the wine to the nearest whole number is given by:

$$100 \times C$$

5.2 Repeatability (*r*): $r = 3$ mg/L.

5.3 Reproducibility (*R*): $R = 8$ mg/L.

Zinc

1. Principle

After removal of alcohol, zinc is determined directly in the wine by atomic absorption spectrophotometry.

2. Apparatus

2.1 Rotary evaporator and thermostatically controlled water bath.

2.2 Atomic absorption spectrophotometer equipped with an air-acetylene burner.

2.3 Zinc hollow cathode lamp.

3. Reagents

The water used must be double distilled in borosilicate glass apparatus or of an equivalent degree of purity.

3.1 Standard solution containing zinc, 1 g/L

Use of a commercial standard zinc solution is preferred. Alternatively this solution may be prepared by dissolving 4.3975 g of zinc sulfate, $ZnSO_4 \cdot 7H_2O$, in water and making up the volume to one liter.

3.2 Dilute standard solution containing 100 mg of zinc per liter.

4. Procedure

4.1 Preparation of sample

Remove the alcohol from 100 mL of wine by reducing the volume of the sample to half its original value using a rotary evaporator (50 to 60 °C). Make up to the original volume of 100 ml, with double distilled water.

4.2 Calibration

Place 0.5, 1, 1.5 and 2 ml, of the solution containing 100 mg zinc per liter into each one of four 100 mL volumetric flasks and make up to the mark with double distilled water. The solutions prepared in this way contain 0.5, 1, 1.5 and 2 mg of zinc per liter respectively.

4.3 Determination

Set the absorbance wavelength to 213.9 nm. Zero the absorbance scale using double distilled water. Aspirate the wine directly into the burner of the spectrophotometer, followed in succession by the four standard solutions. Record the absorbance and repeat each measurement.

5. Expression of results

5.1 Method of calculation

Plot a graph giving the variation in absorbance as a function of zinc concentration in the standard solutions. Record the mean value of the absorbance obtained with the diluted wine sample on this graph and determine its zinc concentration to one decimal place.

Method OIV-MA-AS322-09

Type IV method

Silver

(Recueil OIV ed. 1990 revised by OIV/OENO 377/2009)

1. Principle

The method is based on the use of atomic absorption spectrophotometry after ashing the sample.

2. Apparatus

- 2.1 Platinum dish.
- 2.2 Water bath, thermostatically controlled to 100 °C
- 2.3 Furnace set at 500 to 525 °C.
- 2.4 Atomic absorption spectrophotometer.
- 2.5 Silver hollow cathode lamp.
- 2.6 Gas supplies: air, acetylene.

3. Reagents

- 3.1 Silver nitrate, AgNO_3 .
- 3.2 Nitric acid, ($\rho_{20} = 1.38 \text{ g/mL}$), 65%.
- 3.3 Nitric acid, diluted 1/10 (v/v) with distilled water.
- 3.4 Solution containing 1 g of silver per L.

Use of a standard commercial silver solution is preferred. Alternatively this solution may be prepared by dissolving 1.575 g of silver nitrate in dilute nitric acid and making up to a volume of 1,000 mL with dilute nitric acid (3.3).

- 3.5 Solution containing 10 mg of silver per L.

Take 10 mL of the 1 mg/L solution and make up to 1 L with dilute nitric acid.

4. Procedure

4.1 Preparation of sample

Place 20 mL of the sample in a platinum dish and evaporate to dryness over a boiling water bath. Ash in the furnace at a

**COMPENDIUM OF INTERNATIONAL METHODS OF ANALYSIS -
OIV
Silver**

temperature of 500 to 525 °C. Moisten the white ash with 1 mL of concentrated nitric acid (3.2). Evaporate over a boiling water bath, repeat the addition of 1 mL nitric acid (3.2) and evaporate a second time. Add 5 mL of dilute nitric acid (3.3) and heat gently until dissolved.

4.2 Calibration

Pipette 2, 4, 6, 8, 10 and 20 mL of solution (3.5) respectively into each of size 100 mL volumetric flasks and make up to the mark with dilute nitric acid (3.3): the solutions contain 0.20, 0.40, 0.60, 0.80, 1.0 and 2.0 mg of silver per liter respectively.

4.3 Set the absorbance wavelength to 328.1 nm. Adjust zero using double distilled water. Measure the absorbance directly of successive standard solutions (4.2) and carry out in duplicate.

5. Expression of results

Plot a graph showing the variation in absorbance as a function of the silver concentration in the standard solutions.

Using the measured absorbance of the sample read the concentration C in mg/L from the calibration curve.

The concentration of silver in the wine is given in milligrams per liter by

$$0.25 \times C.$$

It is quoted to two decimal places.

Note: Select the concentration of the solutions for the preparation of the calibration curve. The volume of sample taken and the final volume of the liquid should be appropriate for the sensitivity of the apparatus to be used.

Cadmium

(Recueil OIV ed. 1990 revised by OIV/OENO 377/2009)

1. Principle

Cadmium is determined directly in the wine by graphite furnace atomic absorption spectrophotometry.

2. Apparatus

All the glassware must be washed in concentrated nitric acid prior to use, heated to 70 to 80 °C and rinsed in double distilled water.

2.1 Atomic absorption spectrophotometer equipped with a graphite furnace, background correction and a recorder.

2.2 Cadmium hollow cathode lamp

2.3 5 µl micropipettes with special tips for atomic absorption measurement.

3. Reagents

The water used must be double distilled prepared using borosilicate glass apparatus, or water of a similar purity. All reagents must be of recognized analytical reagent grade and, in particular, free of cadmium.

3.1 Phosphoric acid ($\rho_{20} = 1.71$ g/mL), 85%.

3.2 Phosphoric acid solution obtained by diluting 8 mL of phosphoric acid with water to 100 mL.

3.3 0.02 M Ethylenediaminetetraacetic acid disodium (EDTA) solution.

3.4 pH 9 buffer solution: dissolve 5.4 g of ammonium chloride in a few milliliters of water in a 100 mL volumetric flask, add 35 mL of 25% (v/v) ammonium hydroxide solution. Ammonium hydroxide solution, $\rho_{20} = 0.92$ g/mL, diluted to 25% (v/v) and made up to 100 mL with water.

3.5 Eriochrome black T, 1% (m/m) solution in sodium chloride.

3.6 Cadmium sulfate, $3\text{CdSO}_4 \cdot 8\text{H}_2\text{O}$.

The concentration of the cadmium sulfate must be verified using the following method:

Weigh exactly 102.6 mg of the cadmium sulfate sample into a beaker with some water and shake until dissolved; add 5 mL of the pH 9 buffer solution and approximately 20 mg of Eriochrome black T. Titrate with the EDTA solution (3.3) until the indicator begins to turn blue.

The volume of EDTA added must be equal to 20 mL. If the volume is slightly different, correct the weighed test portion of cadmium sulfate used in the preparation of the reference solution accordingly.

3.7 Cadmium reference solution at 1 g per liter.

Use of a standard commercial solution is preferred. Alternatively this solution may be prepared by dissolving 2.2820 g of cadmium sulfate in water and making up to one liter. Keep the solution in a borosilicate glass bottle with a ground glass stopper.

4. Procedure

4.1 *Preparation of the sample*

The wine is diluted 1/2 (v/v) with the phosphoric acid solution (3.2).

4.2 *Preparation of calibration standards*

Using the cadmium reference solution, prepare successive dilutions 2.5, 5, 10 and 15 µg of cadmium per liter respectively.

4.3 *Determination*

4.3.1 Furnace Programming (for guidance only):

Dry at 100°C for 30 seconds

Mineralize at 900 °C for 20 seconds

Atomize at 2250 °C for 2 to 3 seconds

Nitrogen flow (flushing gas): 6 liters/minute

Note: At the end of the procedure, increase the temperature to 2700 °C to clean the furnace.

4.3.2 Atomic absorption measurements

Select an absorption wavelength of 228.8 nm. Set the zero on the absorbance scale with double distilled water. Using a micropipette, introduce into the furnace three 5 µl portions of

each of the solutions in the calibration range and the sample solution to be analyzed. Record the absorbance measured. Calculate the mean absorbance value from the results for the three portions.

5. Expression of results

5.1 Method of calculation

Draw the absorbance variation curve as a function of the concentration of cadmium in the solutions in the calibration range. The curve is linear. Enter the mean absorbance value of the sample solution on the calibration curve and obtain the cadmium concentration C . The cadmium concentration expressed in micrograms per liter of wine is equal to $2C$.

BIBLIOGRAPHY

- MEDINA B., *Application de la spectrométrie d'absorption atomique sans flamme au dosage de quelques métaux dans les vins*, Thèse Doct. en œnologie, Bordeaux II, 1978.
- MEDINA B. and SUDRAUD P., FV O.I.V 1979, n° 695.

Method OIV-MA-AS322-11

Lead

(OENO 3/94)

1. Principle of the method

Lead is determined directly in wine by flameless atomic absorption spectrophotometry.

WITHDRAWN

Criteria for the methods of quantification of lead in wine

(OENO 7/2006; OIV/OENO 377/2009)

1.1 Method Criteria Definitions

Trueness the closeness of agreement between the average value obtained from a large series of test results and an accepted reference value

$r =$ Repeatability limit, the value below which the absolute difference between 2 single test results obtained under repeatability conditions (i.e., same sample, same operator, same apparatus, same laboratory, and short interval of time) may be expected to lie within a specific probability (typically 95%) and hence $r = 2.8 \times s_r$.

$S_r =$ Standard deviation, calculated from results generated under repeatability conditions.

$RSD_r =$ Relative standard deviation, calculated from results generated under repeatability conditions $[(S_r / \bar{X}) \times 100]$, where \bar{X} is the average of results over all laboratories and samples.

$R =$ Reproducibility limit, the value below which the absolute difference between single test results obtained under reproducibility conditions (i.e., on identical material obtained by operators in different laboratories, using the standardised test method), may be expected to lie within a certain probability (typically 95%); $R = 2.8 \times s_R$.

$S_R =$ Standard deviation, calculated from results under reproducibility conditions.

$RSD_R =$ Relative standard deviation calculated from results generated under reproducibility conditions $[(S_R / \bar{X}) \times 100]$

$Ho_R =$ HORRAT value: the observed RSD_R value divided by the RSD_R value calculated from the Horwitz equation [1].

2 Method of analysis to be used by the laboratory and laboratory control requirements

2.1 Requirements

Specific methods for the determination of lead in wine are not prescribed. Laboratories shall use a method (Type II) validated to OIV requirements [2] that fulfils the performance criteria indicated in Table 1 e.g. GFAA or ICP-MS methods are applicable provided they meet the performance criteria outlined below. Wherever possible, the validation shall include a certified reference material in the collaborative trial test materials. If not an alternative estimation of trueness should be used. Examples of suitably validated methods for the determination of lead in wine are provided in Appendices 1 & 2.

2.2 General considerations

All apparatus which comes into contact with the sample shall be made of an inert material (e.g. polypropylene, polytetrafluoroethylene [PTFE], etc.). The use of ceramic materials is not advisable because of the possibility that lead might be present. If it is not certain that the materials available are free from the analytes in question, their use shall be assessed by means of *ad hoc* studies, which should be considered as an integral part of the validation of the method of analysis. All plastic ware including sample containers shall be acid cleaned. If possible, equipment used for preparing samples should be reserved for lead analyses only.

Table 1: Performance criteria for methods of analyses for lead in wine

Parameter	Value/Comment
Applicability	Suitable for determining lead in wine for official purposes.
Detection limit	No more than one tenth of the value of the OIV limit (expressed in µg/L)
Limit of quantification	No more than one fifth of the value of the OIV limit (expressed in µg/L) except if the value of the limit for lead is less than 100 µg/L. For the latter, no more than two fifth of the value of the specification
Precision	HORRAT values of less or equal to 2 in the validation collaborative trial
Recovery	80% - 105% (as indicated in the collaborative trial)
Specificity	Free from matrix or spectral interferences
Trueness	$\left \frac{\bar{x} - m}{m} \right < 1,96 * \sqrt{S_{R(lab)}^2 - S_{r(lab)}^2 * \left(1 - \frac{1}{n}\right)}$ <p>where m is the certified value of the wine reference material and \bar{x} is the average of n measurements of lead content in this wine, within the same laboratory. $S_{R(lab)}$ and $S_{r(lab)}$ are standard deviations, calculated from results within the same laboratory under reproducibility and repeatability conditions.</p>

2.3 Estimation of the analytical trueness and recovery calculations

Wherever possible the trueness of the analyses shall be estimated [3] by including suitable certified reference materials in the analytical run. The analyst shall also take due note of the ‘Harmonised Guidelines for the Use of Recovery Information in Analytical Measurement’ [4] developed under the auspices of IUPAC/ISO/AOAC. The recovery should be approximately 100 % in which case recovery calculations are of minor importance.

References

- [1] W Horwitz, "Evaluation of Analytical Methods for Regulation of Foods and Drugs", *Anal. Chem.*, 1982, **54**, 67A - 76A
- [2] Protocol for the design, conduct and interpretation of method-performance studies, FV 1061, OIV, 1998
- [3] ISO 5725-6:1994, 4.2.3. International Organisation for Standardisation, case Postal 56, CH-1211, Genève 20, Switzerland.
- [4] ISO/AOAC/IUPAC Harmonised Guidelines for the Use of Recovery Information in Analytical Measurement. *Edited* Michael Thompson, Steven L R Ellison, Ales Fajgelj, Paul Willetts and Roger Wood, *Pure Appl. Chem.*, 1999, **71**, 337 – 348

EXAMPLE 1

DETERMINATION OF LEAD IN WINE BY ATOMIC ABSORPTION SPECTROMETRY

1 SCOPE AND FIELD OF APPLICATION

The method can be used for red, white, still, sparkling and fortified wines.

2 DEFINITION

The lead content of wine: the content of lead determined by this procedure expressed as mg/L.

3 PRINCIPLE

Wine is diluted by a matrix matching cocktail and the lead concentration measured directly by graphite furnace atomic absorption spectrometry (GFAAS). A matrix matching mixture is added to both the wine to be determined and the lead calibration standard solutions. This mixture contains both GFAAS 'matrix modifiers' and wine simulating components. Their purpose is to 'modify' the matrices so that the same shape absorption vs. time profile is obtained from both standard solutions and sample solutions during the graphite furnace atomisation stage.

A delayed atomisation mechanism is required e.g. L'vov platform.

The exact composition of the diluent may need to be adjusted to suit particular models of graphite furnace instruments. Before the method is applied experiments must be conducted to check the absorbance vs. time profiles produced by standards and samples and necessary adjustments made to the diluent. The instrument used must be capable of monitoring the absorbance vs. time profile during atomisation. The profile should be such that standards and samples perform alike and that the lead atomisation peak precedes the bulk of the background non-specific absorption enabling the background correction mechanism employed to operate effectively. Examples of matched profiles are given in Annex 2.

4 REAGENTS

Chemicals should be of the highest quality available in terms of being free of lead. Deionised distilled water, or water of equivalent purity, is to be used. Unless otherwise indicated all solutions are prepared fresh daily.

4.1 Diluent solution

NOTE 1: The exact composition of the diluent used may need adjustment to suit the specific model of instrument and graphite furnace employed. If problems are experienced with the suggested modifier composition adjust the phosphate and nitrate concentrations to give:

i) a stable element signal at the optimum ashing temperature and

ii) atomisation with a single reproducible analyte peak which is time separated from the background signal.

Equipment with VDU facilities will allow analysts to confirm time separation of the sample and background peaks (See Annex). The following is an example of a technique for determining the absorbance versus time profile:

Measure the full peak width at half maximum height (FWHM) of a sample peak and compare it to the FWHM of a calibration standard with a similar maximum absorbance. If the peak shapes are visibly different then the composition of the matrix modification modifier needs to be adjusted.

The following are examples of diluents utilised for:

(a) a Perkin-Elmer 3030 equipped with deuterium arc background corrector with an HGA 500 furnace; and (b) a Thermo-Electron Video 12E equipped with Smith-Hieftje background corrector, a CTF 188 furnace and a FASTAC sample deposition system.

4.1.1 Perkin-Elmer 3030 diluent:

To 187 g of water in a 250 ml plastic bottle (5.1) add 11 g ethanol (4.1.3.), 1.1 g of glucose (4.1.4.), 1.1 g of fructose (4.1.5.) and 0.28 g of sodium chloride (4.1.6.). Shake to dissolve the solids. Then add 22 ml nitric acid (4.1.7.) and 4.4 g ammonium dihydrogen orthophosphate (4.1.8.). Shake until all the phosphate has dissolved. Finally add 0.88 g magnesium nitrate (4.1.9.) and shake again until no undissolved solid remains.

4.1.2 Thermo-Electron Video 12E diluent:

As above but only 0.66 g of ammonium dihydrogen orthophosphate (4.1.8.) and 0.44 g magnesium nitrate (4.1.9.) are used.

4.1.3 Ethanol (absolute)

4.1.4 D-glucose

4.1.5 D(-)fructose

4.1.6 Sodium chloride

4.1.7 Nitric acid (concentrated)

4.1.8 Ammonium dihydrogen orthophosphate

4.1.9 Magnesium nitrate hexahydrate

4.2 10% ethanol (v/v)

To 180 ml water in a 250 ml plastic bottle (5.1.) add using a pipette 20 ml of ethanol (4.1.3.) and shake to mix.

4.3. Lead standard solutions

4.3.1. Lead standard solution (1000 mg/l)

4.3.2 Lead standard solution (10.00 mg/l)

Into a 100 ml volumetric flask (5.2.) pipette (5.7.) 1.00 ml of lead standard solution (4.3.1.). Dilute to volume with water and mix thoroughly.

NOTE 2 : Check calibration of pipette immediately prior to use.

4.3.3 Lead working standard (1.00 mg/l)

Into a 100 ml volumetric flask (5.2.) weigh out 10.00 g of the lead stock solution (4.3.2.) using a Pasteur pipette (5.3.). Wash the inside neck of the volumetric flask with water, add 1 ml of nitric acid (4.1.7.) and make up to the mark with water. Shake to mix thoroughly.

4.3.4. Lead calibration solutions.

The eight calibration standards are made up in universal containers (5.4.). A range of 0 to 50 µg/l is covered by the standards. They are 0.0, 2.5, 5.0, 10.0, 20.0, 30.0, 40.0 and 50.0 µg/l. A ninth container is used to prepare a reagent blank.

Rinse out the inside of each container three times with water and shake dry; rinse the caps three times and shake dry. Leave the capped containers standing upright for 5-10 minutes and then shake out residual liquid. Pipette (5.8) into the 9 containers, in order: 5.00, 5.00, 4.95, 4.90, 4.80, 4.60, 4.40, 4.20 and 4.00 ml of water. Into each of the containers pipette (5.8.) 5.00 ml of 10 % ethanol (4.2) followed by two 5.00 ml aliquots of diluent (4.1).

Into the 9 containers pipette (5.6) (5.7) in order: 0 (reagent blank), 0, 50, 100, 200, 400, 600, 800 and 1000 µl of working standard (4.3.3). Cap the containers and shake to mix the contents. Prepare fresh for each batch of samples.

4.4 1 % (v/v) nitric acid.

5. APPARATUS

All glass and plastic ware used must be acid cleaned (soaked in 20 % nitric acid for at least 24 hours), rinsed thoroughly with distilled water prior to use and kept covered (with cling-film if appropriate) to prevent aerial contamination.

5.1 250 plastic bottles, with caps (for example: Nalgene or equivalent).

5.2 Volumetric flasks, 100 ml (Grade A).

5.3 Pasteur pipettes, with teats

5.4 Universal containers, 30 ml (Nunc, Sterilin or equivalent).

5.5 Glass beakers, 600 ml.

5.6 Pipette*, 40 - 200µl (Labsystems Finnpiipette or equivalent).

5.7 Pipette*, 200 - 1000µl (Labsystems Finnpiipette or equivalent).

5.8 Pipette*, 0.5 - 5.0 ml (Labsystems Finnpiipette or equivalent).

5.9 Pipette*, 2.0 - 10.0 ml (Labsystems Finnpiipette or equivalent).

**NOTE 3: pipettes should be calibrated each day (of use).*

5.10 Analytical balance, (+ or - 1 mg, Mettler PC440 or equivalent).

5.11 Vortex type mixer or equivalent.

5.12 Test tubes, 20 ml capacity.

5.13 Test tube racks, suitable for use with 5.12.

5.14 Container racks, suitable for use with 5.4.

5.15 Magnetic stirrer.

5.16 Magnetic follower, PTFE coated.

5.17 Pipette tips, suitable for use with 5.6, 5.7, 5.8 and 5.9

5.18 Atomic absorption spectrometer,

Atomic absorption spectrophotometer equipped with a graphite furnace, atomisation delay cuvette, auto-injector, background corrector, and absorbance vs. time profile monitoring facility equivalent to the following. Instrumental conditions should be adjusted appropriately for the model used. **The following are given as examples:**

(a) Atomic absorption spectrophotometer, Perkin-Elmer 3030 equipped with deuterium arc background corrector for non-specific absorption. Lead hollow cathode lamp operated at 12 mA. Monitor the 283.3 nm line; slit width 0.7 nm. Graphite furnace, HGA 500 fitted with pyrolytically coated graphite tube with a solid pyrolytic graphite L'vov platform resting inside. Use argon as the purge gas. The furnace conditions for the HGA 500 are as follows:

**COMPENDIUM OF INTERNATIONAL ANALYSIS OF METHODS -
OIV**

Step	1	2	3	4	5	6
Temperature (°C)	200	1100	1100	1800	2400	20
Ramp (s)	5	20	1	0	1	1
Hold (s)	60	20	2	3	6	25
Gas	Ar	Ar	Ar	Ar	Ar	Ar
Gas flow (mL/min)	50	50	0	0	300	300
Read (2.5s integration)				X		

Auto-sampler/injector, AS 40. 20 µl injection volume, 3 injections per tray position.

(b) Thermo-electron Video 12E Atomic absorption spectrophotometer used with a CTF 188 Graphite Furnace and a FASTAC sample deposition system with the following conditions:

(c)(c)

Step	1	2	3	4	5
Temperature (°C)	150	350	650	100 0	240 0
Ramp (s)	0	30	15	1	
Hold (s)	2	0	5	4	10
Gas	Ar	Ar	Ar	Ar	Ar
Gas flow (mL/min)	50	50	0	0	300
Read (2.5s integration)				X	

Sample deposition 5 s, FASTAC delay time 10 s, with 3 injections per tray position. Monitor the 283.3 nm line.

6. PROCEDURE

6.1. Preparation of wine

Shake the wine container to thoroughly mix the contents before sub-sampling. Sparkling wines should be transferred to a clean beaker and placed in an ultrasonic bath until gas is no longer evolved prior to use.

6.2 Measurement solutions

6.2.1 Wine samples

Into a 20 ml test tube (5.12) pipette (5.8) 2.00 ml of water, 4.00 ml of diluent (4.1) and 2.00 ml of the sample wine. Mix thoroughly using the vortex mixer (5.11).

6.2.2 Recovery estimates

For recovery estimate purposes pipette (5.8) into a 20 ml test tube (5.12) 1.80 ml of water, 4.00 ml of diluent (4.1), 2.00 ml of the sample wine and add using a pipette (5.7) 0.200 ml of lead working standard (4.3.3). Mix thoroughly using the vortex mixer (5.11).

NOTE 4: Any sample that exceeds the highest calibration standard will have to be re-analysed using a smaller sample aliquot. Add extra 10% ethanol (4.2) to the sample volume.

6.3. Measurement

Determinations are carried out in batches. Each batch is to contain at least four replicates of the reagent blank and three spiked replicates of samples for recovery estimate purposes. The lead calibration solutions are distributed evenly amongst the unknowns on the auto-sampler tray. Transfer the samples and standards to the auto-sampler sample containers using a Pasteur pipette (5.3). Discard the first filling of the container and measure the second filling (if there is not enough sample solution, care will have to be taken to ensure that the sample containers are scrupulously clean). Wash the Pasteur pipette four or five times with 1% nitric acid (4.4.) between each standard and sample transfer.

6.4. Quantification of lead

The mean absorbance from 3 injections is used in all cases. Construct a calibration graph from the mean responses given by the in-batch standards. Note the absorbances recorded by the instrument for each sample. The lead concentration of the sample solutions are determined by comparison with the calibration graph.

NOTE 5: It is recommended that the furnace tube and platform be replaced every two batches or sooner if there is a marked decrease in the measured absorbance of the standards.

7 EXPRESSION OF RESULTS

Correct the results for the average in-batch recovery.

7.1 Calculation

Obtain from the calibration graph, the lead content of all the measurement solutions. Calculate the lead content of the wine samples and spiked wine samples using the following calculation:

$$\text{Pb concentration (mg/l)} = \frac{(C_m - C_b) \times V_t}{V_m}$$

where:

C_m is the mean lead concentration of the measurement solution (mg/l).

C_b is the mean measured lead concentration of the reagent blank solutions (mg/l).

V_m is the final total volume of the measurement solution (ml).

V_t is the volume of the wine sample taken (ml).

7.2 Calculation of recovery estimates

$$\text{Recovery (\%)} = \frac{(C_s - C_a) \times V_s \times 100}{S}$$

where:

C_s is the calculated mean lead concentration of the spiked wine sample (mg/l).

C_u is the calculated mean lead concentration of the unspiked wine (mg/l).

V is the volume of wine to which the spike is added (ml).

S is the amount of spike added (μg).

7.3 Calculation of recovery corrected results

$$\text{Corrected Pb concentration (mg/L)} = \frac{C_w \times 100}{R_a}$$

where:

C_w is the calculated lead concentration of the wine sample (mg/l).

R_a is the average in-batch recovery (%).

ANNEX: VALIDATION STUDY

The following study was carried out to internationally agreed procedures (1)(2).

TABLE 1 SAMPLE SCHEME

Sample Code	Sample Description
5 & 9	Bordeaux (Sweet White)
3 & 11	Italian Chardonnay (White)
7 & 8	Spanish Red fortified at 260 µg/l
6 & 10	Romanian Pinot Noir
2 & 12	Romanian Pinot Noir fortified with 150 µg/l
1	Sample 3/11 fortified with 124 µg/l
4	Sample 3/11 fortified with 134 µg/l

**TABLE II SUMMARY OF STATISTICAL PARAMETERS FOR
LEAD IN WINE COLLABORATIVE TRIAL (The results from one
laboratory were assessed as being inappropriate for inclusion in the
statistical analysis)**

Sample	A	B	C	D	E	F	F1
Code	5, 9	3, 11	7, 8	6, 10	2, 12	1	4
n	16	15*	16	16	16	16	
n (-outl)	16	15	14	16	15	16	
Targ.	56	24	279	67	192	143	153
Mean	50.8	27.2	298	70.6	189	143	149
r	23	15	24	32	51	38	
S _r	8.1	5.3	8.7	11.8	18.2	13.6	
RSD _r	16	19	3	17	10	9	
Ho_r	1.0	1.1	0.2	1.1	0.7	0.7	
R	42	25	83	57	154	79	
S _R	15.1	8.8	29.8	20.3	55.2	28.2	
RSD_R	30	28	10	29	29	19	
Ho_R	1.2	1.2	0.5	1.2	1.4	0.9	

KEY TO TABLES I-II

N Initial number of laboratories

n(-outl) Number of laboratories after removal of outliers

(*) Laboratory 17 reported <20 µg/l for test material 11. Their results have not been included in the statistical analysis for this sample (B).

Mean The observed mean, the mean obtained from the collaborative trial data after removal of outliers.

Targ. The mean observed value obtained "in-house" using ICP-MS

r Repeatability limit, the value below which the absolute difference between 2 single test results obtained under repeatability conditions (i.e., same sample, same operator, same apparatus, same laboratory, and short interval of time) may be expected to lie within a specific probability (typically 95%) and hence $r = 2.8 \times s_r$.

S_r The standard deviation of the repeatability.

RSD_r The relative standard deviation of the repeatability ($S_r \times 100/\text{MEAN}$).

Ho_r The observed RSD_r divided by the RSD_r value estimated from the Horwitz equation using the assumption $r=0.66R$.

R Reproducibility limit, the value below which the absolute difference between single test results obtained under reproducibility conditions (i.e., on identical material obtained by operators in different laboratories, using the standardised test method), may be expected to lie within a certain probability (typically 95%); $R = 2.8 \times s_R$.

S_R The standard deviation of the reproducibility (between laboratory variation).

RSD_R The relative standard deviation of the reproducibility ($S_R \times 100/\text{MEAN}$).

Ho_R The observed RSD_R value divided by the RSD_R value calculated from the Horwitz equation.

$$\text{RSD}_R = 2(1-0.5\log_{10}C) \quad (\text{where } C = \text{concentration expressed as a decimal})$$

HORRAT⁽⁴⁾ values are:

For repeatability, the observed RSD_r divided by the RSD_r value estimated from the Horwitz equation using the assumption $r = 0.66R$.

For reproducibility, the observed RSD_R divided by the RSD_R value estimated from the Horwitz equation.

8. REFERENCES

8.1 Paul A. Brereton, Paul Robb, Christine M Sargent, Helen M. Crews and Roger Wood. Determination of Lead in Wine by Graphite Furnace Atomic Absorption Spectrometry: Interlaboratory Study. *JAOAC Int.*, 1997, **80**, No 6,

1287-1297.

8.2 "Protocol for the Design, Conduct and Interpretation of Collaborative Studies." Editor W Horwitz, *Pure & Appl. Chem.*, Vol. 67, No., 2, pp.331-343, 1995

8.3 Horwitz W, Evaluation of Methods Used for Regulation of Foods and Drugs, *Analytical Chemistry*, 1982, **57**, 67A-76A.

8.4 Peeler J T, Horwitz W and Albert R, Precision Parameters of Standard Methods of Analysis for Dairy Products, *JAOAC*, 1989, 72, No 5, 784-806.

Annex

Absorbance vs. Time profiles for the measurement of lead in wine
using a Perkin-Elmer 3030 atomic absorption spectrometer
with deuterium arc background correction.

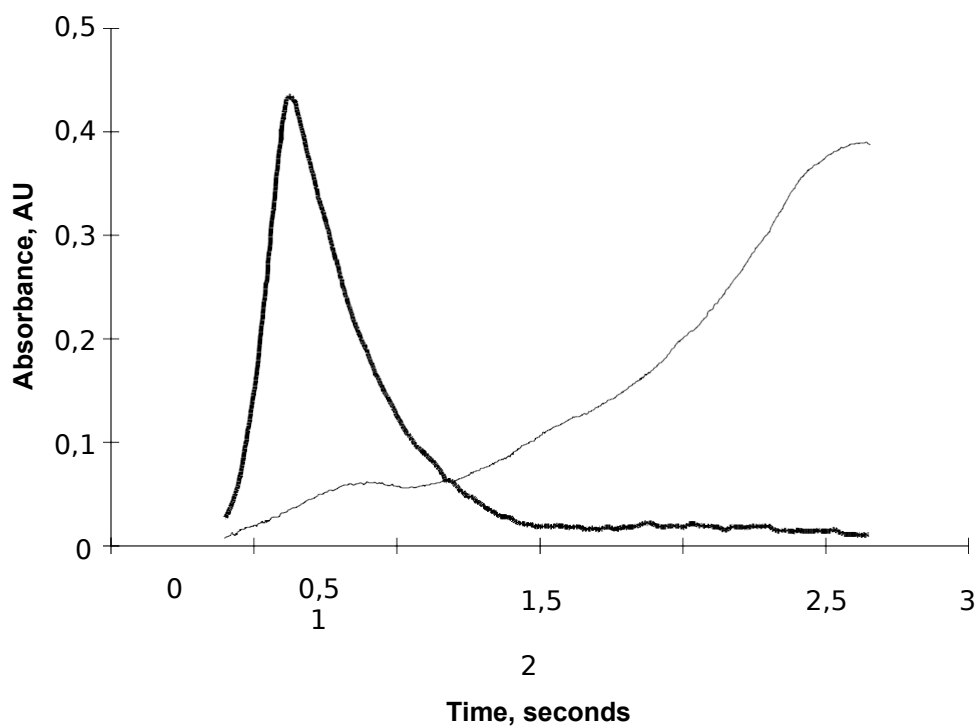

(i) 30 ng/l wine standard

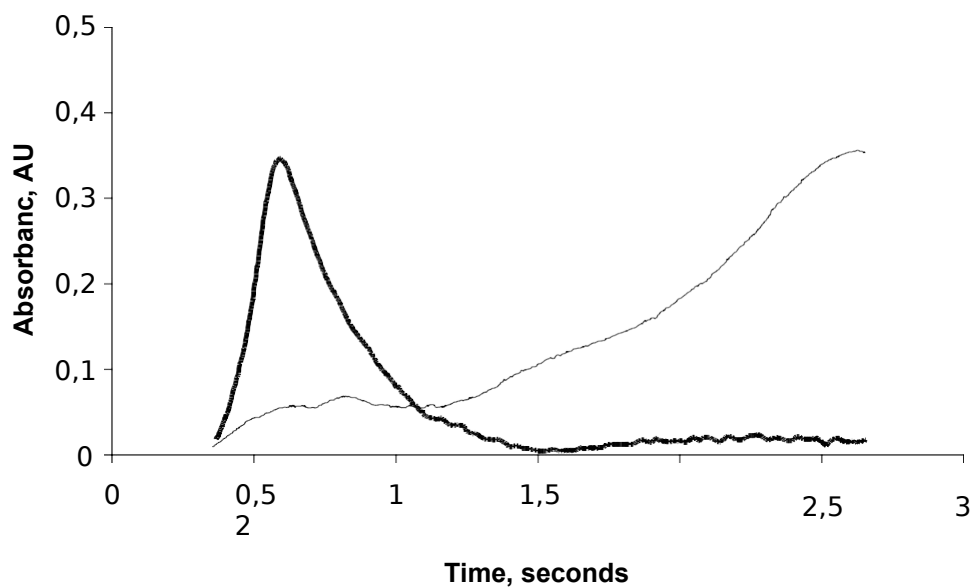

(ii) wine sample

Key: corrected absorbance, — background absorbance

EXAMPLE 2

**DETERMINATION OF LEAD IN WINE BY ATOMIC
ABSORPTION SPECTROMETRY**

1. FIELD OF APPLICATION :

This analysis method can be applied to all types of wine, given the maximum limit set by the O.I.V.

2. REFERENCES:

2.1. Journal Officiel des Communautés Européennes (3 octobre 1990). *Méthode de dosage du plomb dans le vin* (p. 152 et 153).

2.2. Teissèdre P.L., Brun S., Médina B. (1992). *Dosage du plomb dans les vins / Proposition de modifications à la méthode du Recueil*. Feuille Vert de l'O.I.V., n°928, 1997/151292.

2.3. Moreira Balio da Silva M., Gaye J., Médina B. (1996). *Comparaison de six méthodes de dosage du plomb dans les vins par absorption atomique en four graphite*. Feuille Vert de l'O.I.V. n° 1013, 2310/190196.

2.4. Brereton P., Robb P., Sargent C., Crews H., Wood R. (1996). *Validation of a graphite furnace atomic absorption spectrometry method for the detection of lead in wine*. Feuille Vert de l'O.I.V. n° 1016, 2913/230196.

2.5. Bourguignon J.B., Douet Ch., Gaye J., Médina B. (1997). *Dosage du plomb dans le vin / Interprétation des résultats de l'essai interlaboratoire*. Feuille Vert 1055 de l'O.I.V. n° 2456/190397.

3. PRINCIPLE:

The wine will undergo no preparations, except dilution in the case of white sweet wines.

Adding ammonium dihydrogenophosphate enables the lead contained in wine to be stable at high temperatures, which leads to eliminating interferences – and to acting in an identical manner to the standard solution.

The atomizer is a pyrolytic graphite equipped with a platform heated by the Joule effect.

The wavelength of the ray used is 283.3 nanometres.

The non specific absorption correction can be done by the Zeeman effect or by using a deuterium discharge lamp.

The type of lead determination in wine is a direct dosage method with external calibration.

4. REAGENTS

4.1. Demineralised water: ultra pure; with resistivity above 18 MΩ/cm.

4.2. Nitric acid: 65 % ; « suprapur » quality acid.

4.3. Ammonium dihydrogeno-phosphate NH₄H₂PO₄ for analysis.

4.4. Lead standard solution: at 1000 µg/ml (or 1 g/l) in 2% nitric acid (commercial solution, ready to use).

5. APPARTUS

5.1 Analytic balance (e = 1 mg).

5.2 Glass ware:

5.2.1 Volumetric flask 50, 100 ml (class A),

5.2.2 Volumetric pipette 1, 10 ml (class A),

5.2.3 Decontamination of glassware used: rinse in demineralised water; soak at least 24 hours in a basin of 10% nitric acid; rinse two times in demineralised water.

5.3 Atomic absorption spectrophotometer equipped with a graphite tube atomizer for non-specific absorption correction and an auto-sampler (rinse the sampler buckets with 10% nitric acid).

5.3.1. Pyrolytically coated graphite furnace containing an L'Vov platform possibly tantalite (reference 9.1 – see below):

5.3.1.1 Tantalum solution: place 3 g of tantalum powder (metal tantalum with a purity above 99.7%) in a 100 ml teflon cylindrical flask; add 10 ml of diluted fluorhydric acid (1 + 1), 3 g of dehydrated oxalic acid and 0.5 ml of 30% hydrogen peroxide solution; heat together carefully to dissolve metal; add hydrogen peroxide when r reaction slows down. Add 4 g of dehydrated oxalic acid and approximately 30 ml of demineralised water when completely

dissolved. Dissolve acid. Fill the solution up to 50 ml. This solution is stored in a plastic flask.

5.3.1.2 Tantalisation of a platform: the platform is placed inside the graphite tube. These items are placed together on a spectrophotometer atomization unit. 10 µl tantalum solution is injected on a platform using an auto-sampler. The temperature cycle is set according to the following program: drying at 150°C for 40 s; mineralization at 900°C for 60 s; atomization at 2600°C for 2.5 s. Argon is used as an inert gas.

6. PROCEDURE

6.1 Test portion: The neck of the wine bottle with a tinned lead capsule must be carefully cleaned before uncorking.

6.2 Sample preparation: In general, no preparation of wine is necessary; samples are placed directly in the automatic sampler buckets. Cloudy wine needs to be filtered. To prolong the utilisation period of the platforms, sweet white wines are diluted for sugar contents between 10 to 50 g/L, dilute by 1/2; for contents above 50 g/l, dilute by 1/4.

6.3 Preparation of solutions:

6.3.1 White dilution:

The solution is used as an additional volume to be injected and is made up of demineralised water containing 1 % nitric acid (4.2.).

6.3.2 Matrix modifying agent:

Into a 50 ml flask (5.2.1) introduce 3 g of ammonium dihydrogeno-phosphate (4.3.); dissolve and fill with demineralised water (4.1.).

6.3.3 10 mg/ of lead solution:

Into a 100 ml flask (5.2.1) place 1 ml of 1 g/l (4.4.) solution; add 1 % nitric acid (4.2.); fill to volume with demineralised water (4.1.). This solution can be kept one month at a temperature + 4°C.

6.3.4 100 µg/L lead solution:

Into a 100 ml flask (5.2.1) place 1 ml of 10 mg/l (6.3.3.) lead solution; fill to volume with demineralised water (4.1.). This solution must be prepared every analysis day.

6.3.5 *Calibration scale* (for information purposes): 0 ; 16.7 ; 33.3 et 50 µg/l (see Table II).

6.4 Calibration and determination:

6.4.1 *Spectrometric measurement:*

6.4.1.1 wavelength: 283.3 nm;

6.4.1.2 slot with: 0.5 nm;

6.4.1.3 hollow cathode lamp intensity: 5 mA ;

6.4.1.4 correction continuum: by Zeeman or deuterium effect;

6.4.1.5 introduction of standards heated and samples in a graphite furnace using an automatic sampler. The flushing liquid is made up of 500 ml of demineralised water containing a drop of Triton X 100.

Note: in order to inject at 90°C on a platform, the furnace temperature should be regulated to approximately 150°C.

6.4.1.6 signal measurement: peak height;

6.4.1.7 Duration of measurement: 3 seconds;

6.4.1.8 Number of measurements by standard or sample: 2

Note: the average of these two determinations constitutes the trial result. If the variation coefficient for the two determinations is greater than 15 %, the two other determinations must be re-done.

6.4.1.9. Furnace parameters (for information purpose): see Table I.

Table I – Furnace parameters For determination of lead in wine				
Temperature (in °C)	Duration (in s)	Gas type	Gas flow (in l/mn)	lecture du signal
150	60	argon	3.0	
750	10	argon	3.0	
750	30	argon	3.0	
750	2	argon	0	
2400	1	argon	0	oui
2400	2	argon	0	oui
2400	2	argon	3.0	
40	20	argon	3.0	

6.4.1.10. Automatic sampler parameters (for information purposes): see Table II.

Table II – Sampler parameters for the dosage of lead in wine				
Analysis:	volumes injected in μl			
	sample	Pb solution 100 $\mu\text{g/l}$	"white" dilution	Matrix modifier
Calibration blank	0	0	5	1
Standard 1	0	1	4	1
Standard 2	0	2	3	1
Standard 3	0	3	2	1
Sample	2	0	3	1

6.4.2 Tracing of calibration curve: the automatic distributor cycle enables the preparation of standards from 100 $\mu\text{g/l}$ (Table II) lead solutions. The calibration graph is drawn up: absorbency according to lead concentration in micrograms per litre.

7. EXPRESSION OF RESULTS

7.1 Concentration of lead in injected solution: This is obtained from calibration curve (6.4.2.).

7.2 Concentration of lead in wine: This is calculated by multiplying by 3 the result given in 7.1. (2 μl of solution injected for a final volume of 6 μl on the platform). Take into account the possible dilution of wines (in the case of sweet white wines).

7.3 Result: is expressed in milligrams of lead per liter of wine (mg/l), to two digits.

8. INTER-LABORATORY TRIALS

A "double-blind" trial was carried out on 8 different wines obtained from mixtures of Bordeaux wines: two red wines (R1 and R2), two rosé wines (Ro1 and Ro2), two dry white wines (Bs1 and Bs2) and two sweet white wines (D1 and D2). Eleven Spanish, Portuguese, Moroccan and French laboratories participated by determining lead in 16 samples received.

8.1 Presentation of 8 wine samples:

Table III: Characteristics of wine used in interlaboratory trials

Wine	Type	T.A.V. (% Vol.)	Total acidity (g/l H ₂ SO ₄)	Volatile acidity (g/l H ₂ SO ₄)	Reducing sugar (g/l)
R1	Red	11,86	4,43	1,57	1,2
R2	Red	12,54	3,77	0,34	1,5
Ro1	Rosé	12,23	5,30	0,44	1,2
Ro2	Rosé	11,43	4,88	0,45	1,1
Bs1	Dry white	11,65	4,62	0,37	2,2
Bs2	Dry white	12,32	4,57	0,31	0,9
D1	Sweet white	12,94	3,72	0,67	76,4
D2	Sweet white	12,66	4,70	0,45	62,8

**COMPENDIUM OF INTERNATIONAL ANALYSIS OF METHODS -
OIV**

8.2 Statistics of results:

Table IV: Statistical analysis of inter-laboratory trial results

Wine sample	R1	R2	Ro1	Ro2	Bs1	Bs2	D1	D2
Double-blind repetitions	C & K	F & I	D & G	J & L	B & H	P & N	A & E	M & O
Initial number of laboratories	11	11	11	11	11	11	11	11
Number of laboratories After elimination of large variances	11	10	11	11	10	10	11	10
Average (µg/l)	44	162	28	145	52	138	60	145
Repeatability limit r	18	12	7	17	6	13	28	7
Standard deviation of repeatability S _r	6,4	4,3	2,5	6,1	2,1	4,6	10	2,5
Relative standard deviation of reproducibility RSD _r (en %)	14,5	2,8	9,2	4,2	4,2	3,4	16,5	1,8
Horrat value(Ho _r): Observed RSD _r / RSD _r Horwitz	0,6	0,1	0,3	0,2	0,2	0,2	0,7	0,1
Reproducibility limit R	34	105	23	86	30	101	86	144
Standard deviation of reproducibility S _R	12,3	37,5	8,2	30,8	10,7	35,9	30,6	51,6
Relative standard deviation of reproducibility RSD _R (en %)	28	23,1	29,3	21,2	20,6	26	51	35,6
Horrat values (Ho _R): Observed RSD _R / RSD _R Horwitz	1,1	1,1	1,1	1	0,8	1,2	2,1	1,7

Out of the 11 laboratories which participated in the trial, 7 declared that they had followed the proposed method and 4 modified some of the parameters.

9. METHOD PERFORMANCES AND QUALITY CONTROL

9.1 Detection limit: This is determined from a series of 20 blank analytical repetitions and is equal to 3 standard deviations. In the case of the proposed method a series of 20 blank analytical measurements resulted in: average = 1,29 µg/l ; standard deviation = 0,44 µg/l ; detection limit = 1,3 µg/l .

9.2 Limit of quantification: This is equal to 3 times the detection limit. In the case of the proposed method, the limit of quantification is 4 µg/l (3 * 1,32 = 3,96).

9.3 Trueness: The confidence interval for the average of a series of results is compared to the reference material data.

Three reference materials are used including: red wine, dry white wine, sweet white wine for which lead concentrations are certified by the B.C.R. (Bureau Communautaire de Référence) in 1992.

Table V. Trueness of the method

		Red wine BCR E	Dry white wine BCR C	Sweet white wine BCR D
Lead concentration (µg/l)	Certified value (B.C.R. 1992)	36,1 ± 4,9	65,1 ± 9,1	132,4 ± 32
	Average value (series: 10 results)	41,0 ± 3,8	66,0 ± 4,4	128,3 ± 14,1

9.4 Control card

A control card can be drawn up for each reference material used. Control limits are equal to: +/- 2 S_Rintra (S_R intra: reproductibility standard deviation).

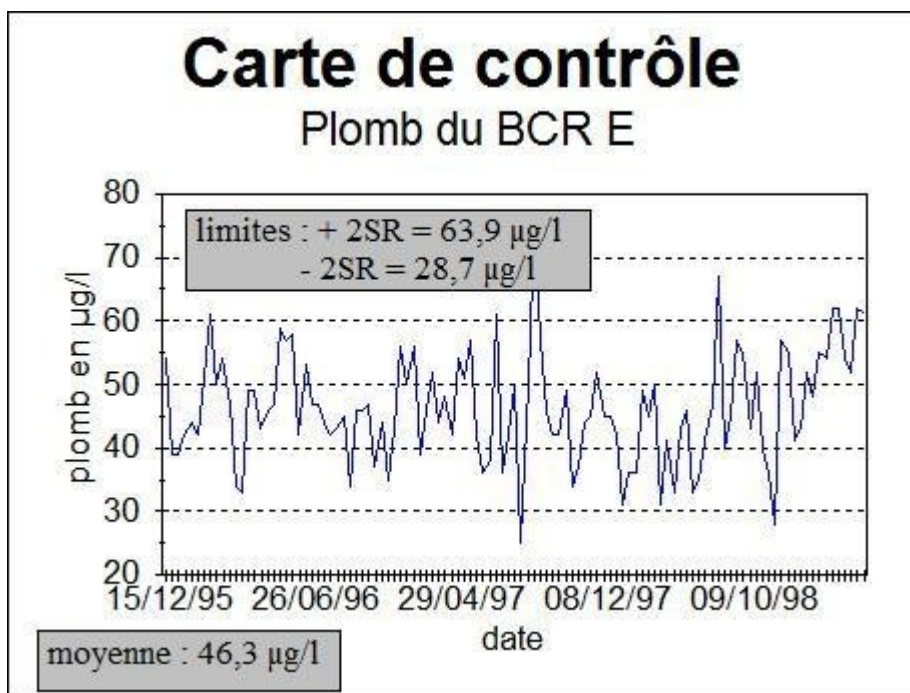

10. BIBLIOGRAPHY

- 10.1. Zátka V. (1978). *Treated graphite atomizer tubes for atomic absorption spectrometry*. Analytical Chemistry, vol. 50, n°3.
- 10.2. US Bureau of Alcohol, Tobacco and Firearms (1991). *Analysis of lead in wines and related products by graphite furnace atomic absorption spectrometry*. Note d'information de l'O.I.V. du 21 août 1991 : « Plomb dans les vins aux U.S.A. ».
- 10.3. Mindak W.R. (1994). *Determination of lead in table wines by graphite furnace atomic absorption spectrometry*. Journal of A.O.A.C. International, vol. 77, n°4, p. 1023-1030.
- 10.4. Médina B. (1994). *Apport de nouvelles techniques au dosage des métaux dans les vins*. Congrès des Œnologues de France à Bordeaux.
- 10.5. Norme française NF ISO 5725-2 (1994). *Application de la statistique : Exactitude (justesse et fidélité) des résultats et méthodes de mesure*.
- 10.6. Jorhem L., Sundström B. (1995). *Direct determination of lead in wine using graphite furnace AAS*. Atomic Spectroscopy, September/October 1995.

**COMPENDIUM OF INTERNATIONAL ANALYSIS OF METHODS -
OIV**

**Analysis of mineral elements in wines using ICP-AES
(inductively coupled plasma / atomic emission spectrometry)**

Method OIV-MA-AS322-13

Type III method

**Analysis of mineral elements in wines using ICP-AES
(inductively coupled plasma / atomic emission spectrometry)**
(OIV-OENO 478-2013)

1. Warning

SAFETY PRECAUTIONS - When handling acids, operators should protect their hands and eyes. Acids must be handled under a suitable hood.

2. Scope

This method specifies an inductively coupled plasma atomic emission spectroscopy (ICP-AES) method to determine the concentration of the following elements in wines:

- Major mineral elements:

- Potassium (up to 1500 mg/L)
- Calcium (up to 250 mg/L)
- Magnesium (up to 150 mg/L)
- Sodium (up to 100 mg/L)

- Minor mineral elements:

- Iron (1 to 10 mg/L)
- Copper (0.1 to 5 mg/L)
- Zinc (0.5 to 5 mg/L)
- Manganese (0.5 to 5 mg/L)
- Strontium (0.1 to 3 mg/L)
- Aluminium (0.75 to 7.5 mg/L)
- Barium (0.1 to 5 mg/L)

COMPENDIUM OF INTERNATIONAL ANALYSIS OF METHODS - OIV

Analysis of mineral elements in wines using ICP-AES (inductively coupled plasma / atomic emission spectrometry)

3. Principle

3.1 Simultaneous analysis of major and minor elements

A 1:5 dilution is used to prepare the samples in this method in order to be able to analyse both the major and minor elements.

The calibration range contains ethanol (2.5%) to take into account the matrix effects related to its presence during nebulisation and at the plasma temperature, along with nitric acid (HNO₃ - 1%) which is used to stabilise the solutions.

The lines Sc _{335.372} (scandium at 5 mg/L) and Cs _{697.327} (caesium as 1% in CsNO₃) proposed in this method can be used as an internal standard in order to minimise the impact of other non-spectral interferences.

Other internal standards, chosen wisely, may also be used in order to optimise the method, such as Y _{371.029}.

Caesium, in the form of CsNO₃, also serves as an ionic buffer when used as an internal standard. The presence of this buffer therefore sets the ionisation balances of the other components. Caesium chloride, CsCl, can also be used as an ionic buffer.

The internal standards and ionic buffer are prepared in the same flask and then introduced into the sample through the addition of a third channel in the peristaltic pump before entering the nebuliser as a homogenous mixture.

3.2 Analysis of the major elements only

The analysis of the major elements only can also be performed by carrying out a 1:50 dilution of the sample. Nitric acid (HNO₃ - 1%) is added into the standards and the samples in order to stabilise the solutions.

Given the dilution performed, the matrix effects are considered negligible. The use of internal standards will not be necessary. Likewise, there will be no need to add ethanol to the calibration range.

4. Reagents and solutions

Unless otherwise specified, all the reagents used must be of a recognised analytical quality.

4.1 Ultra-pure, demineralised water with a resistivity (greater than 18 MΩ), in accordance with the ISO 3696 standard.

**COMPENDIUM OF INTERNATIONAL ANALYSIS OF METHODS -
OIV**

**Analysis of mineral elements in wines using ICP-AES
(inductively coupled plasma / atomic emission spectrometry)**

- 4.2 Certified mono-element solution(s) (to 1000 or 10,000 mg/L) for the mineral elements analysed and the internal standard (scandium for example).
- 4.3 Internal control: certified reference material (wine) or sample from an intercomparison programme between laboratories, comprising the elements analysed.
- 4.4 Nitric acid of a concentration greater than 60% (for trace analysis) (CAS No. 7697-37-2).
- 4.5 Ethanol of a concentration greater than 95% (for trace analysis) (CAS No. 64-17-5).
- 4.6 A solution of 1% nitric acid
Prepare a 1% nitric acid solution by adding 10 mL of nitric acid (4.4) into a 1000 mL flask.

5. Apparatus and equipment

5.1 Optical emission spectrometer with excitation by induced argon plasma and dispersive system (for wavelength analysis, see table in section 7) with axial, radial or dual configuration and preferably sequential PM, CCD, CID or SCCD type detector.

Note 1: Multi-element analysis using a simultaneous type spectrometer is strongly advised if an internal standard is used in the method.

Note 2: Other systems for introducing the sample may be used in order to increase the sensitivity and robustness of the method (continuous flow injection system, microwave desolvation system (MWDS), etc.).

5.2 Calibrated micropipettes making it possible to take volumes from 200 μ L to 5 mL and/or class A 1.5 and 10 mL graduated pipettes.

5.3 Class A volumetric flasks

Note 3: The equipment in contact with the sample must remain in the nitric acid solution (4.4) at a concentration of 10% for 12 hours and then be rinsed several times with the demineralised water (4.1).

In order to assess the robustness of the method on the instrument used, it is recommended that the Mg 279.800/Mg 285.213 intensity ratio is calculated; Mg 285.213 being an atomic line and Mg 279.800 being an ionic line.

**COMPENDIUM OF INTERNATIONAL ANALYSIS OF METHODS -
OIV**

**Analysis of mineral elements in wines using ICP-AES
(inductively coupled plasma / atomic emission spectrometry)**

6. Sample preparation

6.1 Preparing the calibration range

The number of calibration solutions depends on the reliability required. At least five calibration solutions are needed. The reliability and accuracy of the results can be verified by analysing a reference material.

The range will be chosen according to the dilution performed. It should cover the scope of the various elements. It is important that the nitric acid concentration is the same in the standards and samples.

6.1.1 Preparing a standard solution for simultaneous analysis of major and minor elements (1:5 dilution):

Using a micropipette (5.2), introduce the desired volume of standard, 2.5 mL of ethanol (4.5) and 1 mL of nitric acid (4.4) into a 100 mL flask (5.3). Make up to 100 mL with demineralised water (4.1) and mix.

6.1.2 Preparing a standard solution for analysing major elements only (1:50 dilution):

Using a micropipette (5.2), introduce the desired volume of standard into a 100 mL flask (5.3), make up to 100 mL with nitric acid solution (4.6) and mix.

6.2 Preparing the test samples

6.2.1 Preparing test samples for simultaneous analysis of major and minor elements (1:5 dilution):

Using a graduated pipette or micropipette (5.2), introduce 10 mL of sample and 1 mL of nitric acid (4.4) into a 50 mL flask (5.3). Make up to 50 mL with demineralised water (4.1) and mix.

Sparkling wine samples must be subjected to degassing using an ultrasound bath for example, for at least 10 minutes.

Particularly for samples rich in sugar, mineralisation by microwave digestion in nitric acid is used to destroy organic compounds. Finally, a higher dilution may need to be considered due to a concentration which is too high for certain elements. In this case, the ethanol content may be adjusted accordingly in the solutions and standards.

Note 4: Depending on the robustness of the instrument used and given the use of the ionic buffer and internal standards, it is possible to work with a 1:2 dilution

**COMPENDIUM OF INTERNATIONAL ANALYSIS OF METHODS -
OIV**

**Analysis of mineral elements in wines using ICP-AES
(inductively coupled plasma / atomic emission spectrometry)**

factor in order to improve the sensitivity of the method for trace elements. As a result, the calibration ranges, ethanol content and possibly the experimental parameters (power) must be modified.

6.2.2 Preparing test samples for analysing major elements only (1:50 dilution)

Using a graduated pipette or micropipette (5.2), introduce 1 mL of wine sample and 0.5 mL of nitric acid (4.4) into a 50 mL flask (5.3). Make up to 100 mL with demineralised water (4.1) and mix.

7. Procedure

Experimental parameters

The optimal instrument parameters that have enabled us to achieve the specificity for this method in terms of repeatability and reproducibility are described below. They are presented here as an example and may be modified depending on the instrument used.

Power: 1.3 kW

Plasma gas flow: 15 L/min

Auxiliary gas flow: 1.5 L/min

Nebuliser pressure: 200 kPa

Stabilisation period: 20 s

Measurement time per replicate: 5 s

Pump speed: 15 rpm

Rinsing time: 30 s

Internal standard inlet internal diameter: 0.51 mm

Sample inlet internal diameter: 0.8 mm

Turn the unit on (pump operational and plasma switched on) and clean the system for at least 20 minutes with 1% nitric acid (4.6).

Analyse a blank following the series of standards in increasing order of concentration. A reference sample (4.3) can be used as internal quality control to verify that the calibration is satisfactory. Next, analyse the blank again to ensure the absence of memory effect. Next, conduct the analysis of the samples by inserting a quality control every 10 samples and at the end of the analysis series.

**COMPENDIUM OF INTERNATIONAL ANALYSIS OF METHODS -
OIV**

**Analysis of mineral elements in wines using ICP-AES
(inductively coupled plasma / atomic emission spectrometry)**

A control chart can be drawn up from the results obtained in relation to the control sample in order to define the acceptance criteria and actions to be performed in the event of drift.

The analyses will be performed for each element with a minimum of 3 replicates.

Lines that can be used for the various elements (other lines may be used depending on the equipment).

Elements	Main line ($E_{sum} = E_{exc} + E_{ion}$)	Associated internal standard	Secondary line ($E_{sum} = E_{exc} + E_{ion}$)	Associated internal standard
K	769.897 (I) (1.6 eV)	Cs 697.327	766.491 (I) (1.6 eV)	Cs 697.327
Ca	317.933 (II) (10 eV)	Sc 335.372	315.887 (II) (10.1 eV)	Sc 335.372
Mg	285.213 (I) (4.3 eV)	Cs 697.327	279.800 (II) (10.6 eV)	Sc 335.372
Na	589.592 (I) (2.1 eV)	Cs 697.327		
Fe	259.940 (II) (12.7 eV)	Sc 335.372	239.563 (II) (11.4 eV)	Sc 335.372
Cu	327.395 (I) (3.8 eV)	Cs 697.327	324.754 (I) (3.8 eV)	Cs 697.327
Zn	213.857 (I) (5.8 eV)	Cs 697.327	206.200 (II) (12.2 eV)	Sc 335.372
Mn	257.61 (II) (12.3 eV)	Sc 335.372	260.568 (II) (11 eV)	Sc 335.372
Sr	421.552 (II) (8.6 eV)	Sc 335.372	407.771 (II) (8.7 eV)	Sc 335.372
Al	396.152	Cs 697.327	167.019 (I)	Cs 697.327

**COMPENDIUM OF INTERNATIONAL ANALYSIS OF METHODS -
OIV**

**Analysis of mineral elements in wines using ICP-AES
(inductively coupled plasma / atomic emission spectrometry)**

	(I) (3.1 eV)		(7.4 eV)	
Rb	780.026 (I) (1.6 eV)	Cs 697.327		
Li	670.783 (I) (1.9 eV)	Cs 697.327		
Ba	455.403 (II) (7.9 eV)	Sc 335.372		
Sc	335.372 (II) (10.3 eV)			
Cs	697.327 (I) (1.8 eV)			

8. Calculation

Calculate the concentration of the elements in the sample using the following equation:

$$C = \frac{C_m \times V_t}{V_m}$$

Where:

C: concentration of the element in the wine sample (mg/L)

C_m: concentration of the element in the diluted solution (mg/L)

V_t: volume of the dilution flask (mL) (here *V*=50 mL)

V_m: volume of the sample taken for dilution (mL) (here *V*=1 or 10 mL)

**COMPENDIUM OF INTERNATIONAL ANALYSIS OF METHODS -
OIV**

**Analysis of mineral elements in wines using ICP-AES
(inductively coupled plasma / atomic emission spectrometry)**

9. Precision

Elements	Repeatability y (RSD %)	Reproducibility y (RSD %)	LD (mg/L)	LQ (mg/L)	Recovery rate
K	2.3	5.5	major	major	Between 80% and 120%
Ca	3.5	11.3	major	major	
Mg	2.4	8.9	major	major	
Na	2.6	9.1	major	major	
Fe	2.2	6.9	0.08	0.25	
Cu	13.4	15.8	0.03	0.10	
Zn	3.6	6.5	0.03	0.10	
Mn	4.7	7.0	0.03	0.10	
Al	5.6	17.0	0.03	0.10	
Sr	2.1	9.9	0.03	0.10	
Ba	8.2	20.8	0.03	0.10	

**COMPENDIUM OF INTERNATIONAL ANALYSIS OF METHODS -
OIV**

**Analysis of mineral elements in wines using ICP-AES
(inductively coupled plasma / atomic emission spectrometry)**

APPENDIX:

VALIDATION STUDY – Results of the collaborative trials

A validation study was performed in November 2011 (pre-study) and in February 2012 (validation study) in accordance with ISO 5725 and resolution OENO 6/2000.

Pre-study:

3 samples (dry white wine, red wine and sweet white wine), spiked with Al, Fe, Cu, Sr, Ba, Mn and Zn.

Element (mg/L)	Samples		
	Red wine	Dry white wine	Sweet wine
K	1258	725	841
Ca	50	75	81
Na	20	28	24
Mg	78	70	66
Al	1.29	1.33	1.97
Fe	8.12	6.91	9.29
Cu	0.86	0.86	0.94
Sr	1.07	1.08	1.07
Ba	0.77	0.72	0.63
Mn	1.6	2.01	1.77
Zn	1.51	2.53	1.69

**COMPENDIUM OF INTERNATIONAL ANALYSIS OF METHODS -
OIV**

**Analysis of mineral elements in wines using ICP-AES
(inductively coupled plasma / atomic emission spectrometry)**

SAMPLES

Element	White wine 1			White wine 2		
	Ref value (mg/L)	Spike (mg/L)	Recovery %	Ref value (mg/L)	Spike (mg/L)	Recovery %
K	754	0	98	1080	351	96
Ca	83	11	98	76	0	102
Na	50	28	105	24	0	100
Mg	65	0	98	72	7	102
Al	0.50	0	100	1.19	1	104
Fe	2.86	1	94	1.71	0	97
Cu	0.04	0	no add.	0.71	1	103
Sr	1.27	1	105	0.22	0	108
Ba	0.08	0	102	0.64	1	96
Mn	1.84	1	98	1.12	0	102
Zn	1.40	0	100	2.12	1	102

Element	Red wine 1			Red wine 2		
	Ref value (mg/L)	Spike (mg/L)	Recovery %	Ref value (mg/L)	Spike (mg/L)	Recovery %
K	1160	70	100	1371	316	95
Ca	62	1	103	67	7	101
Na	71	56	100	19	0	100
Mg	82	7	102	80	0	99
Al	0.81	0	105	1.82	1	103
Fe	4.90	0	101	4.55	0	101
Cu	0.46	0	102	0.12	0	65
Sr	0.28	0	102	1.32	1	105
Ba	0.12	0	102	0.62	1	97
Mn	1.81	1	100	1.10	0	101

**COMPENDIUM OF INTERNATIONAL ANALYSIS OF METHODS -
OIV**

**Analysis of mineral elements in wines using ICP-AES
(inductively coupled plasma / atomic emission spectrometry)**

Zn	0.95	0	107	1.68	1	101
----	------	---	-----	------	---	-----

Element	Sweet wine 1			Sweet wine 2		
	Ref value (mg/L)	Spike (mg/L)	Recovery %	Ref value (mg/L)	Spike (mg/L)	Recovery %
K	1105	246	96	832	0	102
Ca	85	4	99	92	10	101
Na	68	42	98	21	0	100
Mg	63	0	97	66	6	101
Al	1.65	1	101	0.80	0	96
Fe	3.03	0	97	4.63	0	101
Cu	0.73	1	101	0.12	0	94
Sr	1.73	1	106	0.22	0	96
Ba	0.11	0	94	0.34	0	90
Mn	1.01	0	99	1.62	1	102
Zn	1.53	1	102	1.18	0	100

Participant laboratories had the choice to carry out the analysis of elements

- either in two steps: high dilution for major elements and low dilution for minor elements, preferably with internal standards.
- or in one step: the same dilution for all elements with internal standards.

For each sample number and for each determination, the first individual value was used. The two individual portions of blind identical replicas per laboratory are considered as a single material.

Outlier elimination was performed using a sequential application of the Cochran (applied to variances) and Grubbs (applied to mean values) tests (at a 2.5% probability (P) level, 1-tail for Cochran and 2-tail for Grubbs) until no further outliers were flagged or until a drop of 22.2% in the original number of laboratories providing valid data occurred.

With the exception of the element calcium in the "sweet wine 2" sample, which exhibits a Horrat R value of 2.2, all the elements were compliant. For this sample, 93% of the laboratories have a satisfactory Z-score (14 results) and 7% of the laboratories have a questionable Z-score (1 result). Consequently, as the five other samples were compliant for the determination of calcium, including another sweet

**COMPENDIUM OF INTERNATIONAL ANALYSIS OF METHODS -
OIV**

**Analysis of mineral elements in wines using ICP-AES
(inductively coupled plasma / atomic emission spectrometry)**

wine sample with the same calcium concentration, it was decided to validate this element and to include it in the analytical method.

For the determination of major elements, 9 laboratories used a high dilution and 6 laboratories used a single dilution for all (major and minor) elements. There were no differences between the results of both groups.

Tableau 1 - Potassium

Statistical parametres	White Wine 1	White Wine 2	Red wine 1	Red wine 2	Sweet wine 1	Sweet wine 1
Total	15,00	15,00	15,00	15,00	15,00	15,00
Accepted	13,00	13,00	14,00	11,00	14,00	14,00
Repetitions	2,00	2,00	2,00	2,00	2,00	2,00
Vréf (mg/L)	754,38	1079,82	1160,33	1370,96	1105,46	831,62
Limit of repeatability - r	22,45	47,32	132,68	50,64	124,78	42,92
RSD r (%)	1,10	1,50	4,00	1,30	4,00	1,80
RSD r Horwitz	3,90	3,69	3,65	3,56	3,68	3,84
r Horrat	0,30	0,40	1,10	0,40	1,10	0,50
Limite de reproductibility - R	139,25	182,82	165,46	147,56	176,10	142,93
RSD R (%)	6,50	6,00	5,00	3,80	5,60	6,10
RSD R Horwitz	5,90	5,59	5,53	5,39	5,57	5,82
R Horrat	1,10	1,10	0,90	0,70	1,00	1,00

**COMPENDIUM OF INTERNATIONAL ANALYSIS OF METHODS -
OIV**

**Analysis of mineral elements in wines using ICP-AES
(inductively coupled plasma / atomic emission spectrometry)**

Tableau 2 - Calcium

Statistical parametres	White Wine 1	White Wine 2	Red wine 1	Red wine 2	Sweet wine 1	Sweet wine 1
Total	15,00	15,00	15,00	15,00	15,00	15,00
Accepted	10,00	10,00	13,00	10,00	13,00	15,00
Repetitions	2,00	2,00	2,00	2,00	2,00	2,00
Vréf (mg/L)	85,37	73,43	67,68	66,00	78,35	92,39
Limit of repeatability - r	3,30	4,12	4,60	2,86	7,96	26,66
RSD r (%)	2,10	2,00	2,40	1,50	3,60	10,20
RSD r Horwitz	5,85	5,53	5,60	5,62	5,48	5,34
r Horrat	0,30	0,40	0,40	0,30	0,70	1,90
Limite de reproductibility - R	10,68	10,45	42,58	9,51	29,85	45,60
RSD R (%)	4,40	5,00	22,20	5,10	13,50	17,40
RSD R Horwitz	8,19	8,38	8,48	8,52	8,30	8,10
R Horrat	0,50	0,60	2,60	0,60	0,60	2,20

**COMPENDIUM OF INTERNATIONAL ANALYSIS OF METHODS -
OIV**

**Analysis of mineral elements in wines using ICP-AES
(inductively coupled plasma / atomic emission spectrometry)**

Tableau 3 - Sodium

Statistical parametres	White Wine 1	White Wine 2	Red wine 1	Red wine 2	Sweet wine 1	Sweet wine 1
Total	15,00	15,00	15,00	15,00	15,00	15,00
Accepted	15,00	13,00	12,00	12,00	14,00	15,00
Repetitions	2,00	2,00	2,00	2,00	2,00	2,00
Vréf (mg/L)	50,50	24,09	71,43	18,76	67,91	21,42
Limit of repeatability - r	3,00	1,32	2,53	1,73	5,20	1,85
RSD r (%)	2,10	1,90	1,20	3,30	2,70	3,00
RSD r Horwitz	5,85	6,54	5,55	6,79	5,60	6,6
r Horrat	0,30	0,30	0,20	0,50	0,50	0,50
Limite de reproductibility - R	9,41	6,09	15,19	6,72	13,09	6,49
RSD R (%)	6,60	9,90	7,50	12,70	6,80	10,70
RSD R Horwitz	8,87	9,91	8,42	10,29	8,48	10,09
R Horrat	0,70	0,90	0,90	1,20	0,80	1,10

**COMPENDIUM OF INTERNATIONAL ANALYSIS OF METHODS -
OIV**

**Analysis of mineral elements in wines using ICP-AES
(inductively coupled plasma / atomic emission spectrometry)**

Tableau 4 - Magnésium

Statistical parametres	White Wine 1	White Wine 2	Red wine 1	Red wine 2	Sweet wine 1	Sweet wine 1
Total	15,00	15,00	15,00	15,00	15,00	15,00
Accepted	15,00	15,00	14,00	14,00	13,00	14,00
Repetitions	2,00	2,00	2,00	2,00	2,00	2,00
Vréf (mg/L)	65,30	72,03	82,15	80,01	62,63	65,53
Limit of repeatability - r	3,43	4,29	10,27	7,25	5,32	2,27
RSD r (%)	1,90	2,10	4,40	3,20	3,00	1,20
RSD r Horwitz	5,63	5,55	5,44	5,46	5,67	5,63
r Horrat	0,30	0,40	0,80	0,60	0,50	0,20
Limite de reproductibility - R	15,26	16,33	29,80	20,23	15,86	13,74
RSD R (%)	8,30	8,00	12,80	8,90	8,90	7,40
RSD R Horwitz	8,53	8,40	8,24	8,27	8,58	8,53
R Horrat	1,00	1,00	1,60	1,10	1,00	0,90

**COMPENDIUM OF INTERNATIONAL ANALYSIS OF METHODS -
OIV**

**Analysis of mineral elements in wines using ICP-AES
(inductively coupled plasma / atomic emission spectrometry)**

Tableau 5 - Aluminium

Statistical parametres	White Wine 1	White Wine 2	Red wine 1	Red wine 2	Sweet wine 1	Sweet wine 1
Total	15,00	15,00	15,00	15,00	15,00	15,00
Accepted	10,00	9,00	8,00	8,00	9,00	8,00
Repetitions	2,00	2,00	2,00	2,00	2,00	2,00
Vréf (mg/L)	0,50	1,19	0,81	1,82	1,65	0,80
Limit of repeatability - r	0,19	0,11	0,22	0,15	0,15	0,05
RSD r (%)	13,10	3,30	9,40	2,80	3,20	2,10
RSD r Horwitz	11,71	10,29	10,89	9,65	9,79	10,93
r Horrat	1,10	0,30	0,90	0,30	0,30	0,20
Limite de reproductibility - R	0,42	0,33	0,33	0,46	0,97	0,41
RSD R (%)	29,80	10,00	14,20	8,90	20,80	18,10
RSD R Horwitz	17,75	15,59	16,50	14,61	14,84	16,56
R Horrat	1,70	0,60	0,90	0,60	1,40	1,10

**COMPENDIUM OF INTERNATIONAL ANALYSIS OF METHODS -
OIV**

**Analysis of mineral elements in wines using ICP-AES
(inductively coupled plasma / atomic emission spectrometry)**

Tableau 6 - Fer

Statistical parametres	White Wine 1	White Wine 2	Red wine 1	Red wine 2	Sweet wine 1	Sweet wine 1
Total	10,00	10,00	10,00	10,00	10,00	10,00
Accepted	6,00	7,00	7,00	6,00	7,00	7,00
Repetitions	2,00	2,00	2,00	2,00	2,00	2,00
Vréf (mg/L)	2,86	1,71	4,90	4,55	3,03	4,63
Limit of repeatability - r	0,19	0,06	0,57	0,33	0,21	0,70
RSD r (%)	2,30	1,30	4,10	2,60	2,40	0,50
RSD r Horwitz	9,02	9,74	8,31	8,41	8,94	8,38
r Horrat	0,30	0,10	0,50	0,30	0,30	0,10
Limite de reproductibility - R	0,20	0,29	0,99	0,34	0,34	2,52
RSD R (%)	2,50	6,10	7,10	2,60	3,90	19,20
RSD R Horwitz	13,66	14,76	12,59	12,74	13,54	12,70
R Horrat	0,20	0,40	0,60	0,20	0,30	1,50

**COMPENDIUM OF INTERNATIONAL ANALYSIS OF METHODS -
OIV**

**Analysis of mineral elements in wines using ICP-AES
(inductively coupled plasma / atomic emission spectrometry)**

Tableau 7 - Cuivre

Statistical parametres	White Wine 1	White Wine 2	Red wine 1	Red wine 2	Sweet wine 1	Sweet wine 1
Total	9,00	10,00	10,00	10,00	10,00	10,00
Accepted	7,00	10,00	8,00	10,00	8,00	10,00
Repetitions	2,00	2,00	2,00	2,00	2,00	2,00
Vréf (mg/L)	0,04	0,71	0,46	0,12	0,73	0,12
Limit of repeatability - r	0,03	0,10	0,08	0,05	0,03	0,10
RSD r (%)	24,30	4,80	6,00	14,40	1,70	29,00
RSD r Horwitz	16,95	11,12	11,87	14,62	11,07	14,55
r Horrat	1,40	0,40	0,50	1,00	0,20	2,00
Limite de reproductibility - R	0,03	0,21	0,09	0,05	0,14	0,10
RSD R (%)	24,30	10,40	6,80	16,40	6,80	30,10
RSD R Horwitz	25,68	16,84	17,98	22,15	16,77	22,05
R Horrat	0,90	0,60	0,40	0,70	0,40	1,40

**COMPENDIUM OF INTERNATIONAL ANALYSIS OF METHODS -
OIV**

**Analysis of mineral elements in wines using ICP-AES
(inductively coupled plasma / atomic emission spectrometry)**

Tableau 8 – Strontium

Statistical parametres	White Wine 1	White Wine 2	Red wine 1	Red wine 2	Sweet wine 1	Sweet wine 1
Total	8,00	8,00	8,00	8,00	8,00	8,00
Accepted	7,00	7,00	7,00	6,00	7,00	6,00
Repetitions	2,00	2,00	2,00	2,00	2,00	2,00
Vréf (mg/L)	1,27	0,22	0,28	1,32	1,73	0,22
Limit of repeatability - r	0,03	0,01	0,04	0,06	0,12	0,00
RSD r (%)	1,00	1,70	5,50	1,70	2,60	0,50
RSD r Horwitz	10,19	13,25	12,76	10,13	9,72	13,30
r Horrat	0,01	0,10	0,40	0,20	0,30	0,00
Limite de reproductibility - R	0,18	0,07	0,12	0,09	0,24	0,12
RSD R (%)	5,10	11,40	15,30	2,50	5,00	20,00
RSD R Horwitz	15,44	20,08	19,34	15,34	14,73	22,15
R Horrat	0,30	0,60	0,80	0,20	0,30	1,00

**COMPENDIUM OF INTERNATIONAL ANALYSIS OF METHODS -
OIV**

**Analysis of mineral elements in wines using ICP-AES
(inductively coupled plasma / atomic emission spectrometry)**

Tableau 9 - Barium

Statistical parametres	White Wine 1	White Wine 2	Red wine 1	Red wine 2	Sweet wine 1	Sweet wine 1
Total	8,00	8,00	8,00	8,00	8,00	8,00
Accepted	7,00	8,00	8,00	7,00	8,00	8,00
Repetitions	2,00	2,00	2,00	2,00	2,00	2,00
Vréf (mg/L)	0,08	0,64	0,12	0,62	0,11	0,34
Limit of repeatability - r	0,01	0,38	0,01	0,16	0,01	0,06
RSD r (%)	5,70	21,00	3,60	9,20	3,30	6,30
RSD r Horwitz	15,33	11,30	14,52	11,34	14,73	12,41
r Horrat	0,40	1,90	0,20	0,80	0,20	0,50
Limite de reproductibility - R	0,04	0,38	0,05	0,54	0,05	0,24
RSD R (%)	18,80	21,00	13,90	30,07	15,80	24,50
RSD R Horwitz	23,23	17,12	22,00	17,18	22,32	18,80
R Horrat	0,80	1,20	0,60	1,80	0,70	1,30

**COMPENDIUM OF INTERNATIONAL ANALYSIS OF METHODS -
OIV**

**Analysis of mineral elements in wines using ICP-AES
(inductively coupled plasma / atomic emission spectrometry)**

Tableau 10 - Manganèse

Statistical parametres	White Wine 1	White Wine 2	Red wine 1	Red wine 2	Sweet wine 1	Sweet wine 1
Total	10,00	10,00	10,00	10,00	10,00	10,00
Accepted	9,00	10,00	9,00	10,00	8,00	8,00
Repetitions	2,00	2,00	2,00	2,00	2,00	2,00
Vréf (mg/L)	1,84	1,12	1,81	1,10	0,11	1,62
Limit of repeatability - r	0,09	0,21	0,49	0,14	0,13	0,60
RSD r (%)	1,60	6,50	9,60	4,50	4,60	1,30
RSD r Horwitz	9,64	10,38	9,66	10,41	10,55	9,82
r Horrat	0,20	0,60	1,00	0,40	0,40	0,10
Limite de reproductibility - R	0,25	0,21	0,49	0,22	0,22	0,38
RSD R (%)	4,80	6,50	9,60	7,10	7,10	8,30
RSD R Horwitz	14,60	15,73	14,63	15,78	15,98	14,88
R Horrat	0,30	0,40	0,70	0,50	0,30	0,60

**COMPENDIUM OF INTERNATIONAL ANALYSIS OF METHODS -
OIV**

**Analysis of mineral elements in wines using ICP-AES
(inductively coupled plasma / atomic emission spectrometry)**

Tableau 11 - Zinc

Statistical parametres	White Wine 1	White Wine 2	Red wine 1	Red wine 2	Sweet wine 1	Sweet wine 1
Total	10,00	10,00	10,00	10,00	10,00	10,00
Accepted	7,00	8,00	9,00	8,00	7,00	7,00
Repetitions	2,00	2,00	2,00	2,00	2,00	2,00
Vréf (mg/L)	1,40	2,12	0,95	1,68	1,53	1,18
Limit of repeatability - r	0,09	0,16	0,22	0,10	0,18	0,05
RSD r (%)	2,40	2,60	8,40	2,20	4,20	1,60
RSD r Horwitz	10,03	9,43	10,65	9,77	9,91	10,30
r Horrat	0,20	0,30	0,80	0,20	0,40	0,20
Limite de reproductibility - R	0,10	0,39	0,29	0,36	0,22	0,22
RSD R (%)	2,40	6,50	10,70	7,60	5,10	6,70
RSD R Horwitz	15,20	14,28	16,13	14,80	15,01	15,61
R Horrat	0,20	0,50	0,70	0,50	0,30	0,40

**COMPENDIUM OF INTERNATIONAL ANALYSIS OF METHODS -
OIV**

**Analysis of mineral elements in wines using ICP-AES
(inductively coupled plasma / atomic emission spectrometry)**

2/ Laboratoires participants :

Onze laboratoires ont participé à cette étude collaborative :

- State General Laboratory, NMR Lab, Nicosia Chypre
- ANALAB CHILE S.A., Santiago Chile
- CISTA, National Reference Laboratory Brno Czech Republic
- Laboratório de Análises- REQUIMTE- FCT/UNL, Caparica Portugal
- Laboratório Central de Análises - Universidade de Aveiro Portugal
- Laboratory of National Center of Alcoholic Beverages Testing, Chisinau Republic of Moldova
- National Research Institute of Brewing, Higashihiroshima Japon
- Instituto Nacional de Vitivinicultura, Laboratorio General, Mendoza Argentine
- LFZ Wein und Obstbau, Klosterneuburg Autriche
- Laboratorio Arbitral Agroalimentario, Madrid Spain
- Laboratoire SCL de Bordeaux-Pessac France

**Determination of arsenic in wine
by atomic absorption spectrometre**
(OENO 14/2002 revised by OIV/OENO 377/2009)

1. PRINCIPLE

After evaporating ethyl alcohol and reducing the arsenic V in arsenic III, wine arsenic is measured by hydride generation and by atomic absorption spectrometry.

2. EQUIPMENT

2.1. Glass ware:

- 2.1.1. Graduated flask 50, 100 ml (class A)
- 2.1.2. Graduated pipettes 1, 5, 10, 25 ml (class A)

2.2. Water bath at 100°C

2.3. Filters without ashes

2.4. Spectrophotometer :

- 2.4.1. Atomic absorption spectrophotometer
- 2.4.2. Instrumental parameters
 - 2.4.2.1. Air-acetylene oxidising flame
 - 2.4.2.2. Hollow cathode lamp (arsenic)
 - 2.4.2.3. Wave length: 193.7 nm
 - 2.4.2.4. Split width: 1.0 nm
 - 2.4.2.5. Intensity of hollow cathode lamp: 7 mA
 - 2.4.2.6. Correction of non-specified absorption with a deuterium lamp

2.5. Accessories:

- 2.5.1. Hydride absorption cell, placed on an air-acetylene burner.
- 2.5.2. Vapour generator (liquid gas separator)
- 2.5.3. Neutral gas (argon)

**COMPENDIUM OF INTERNATIONAL METHODS OF ANALYSIS -
OIV
Arsenic - Atomic absorption**

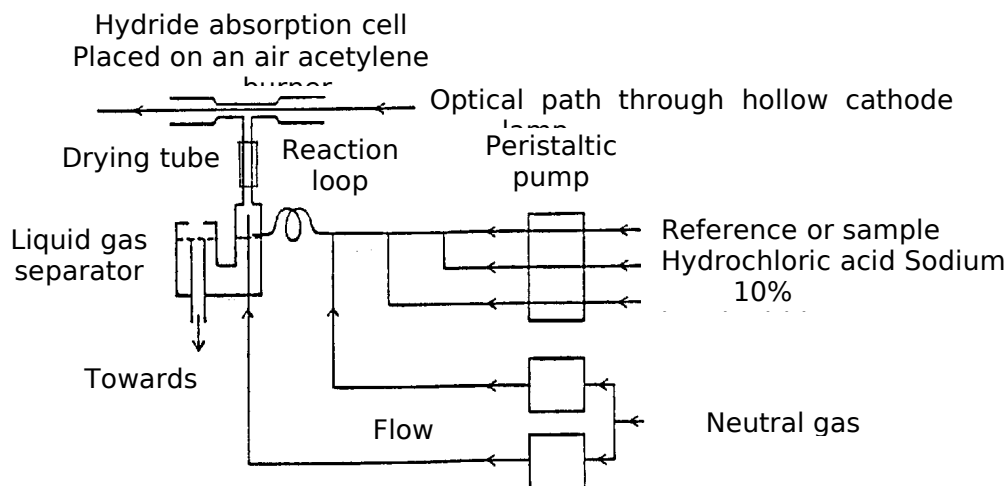

Figure 1. Hydride generator.

3. REAGENTS

- 3.1. Ultra-pure demineralised water
- 3.2. Ultra-pure 65% nitric acid
- 3.3. Potassium iodide (KI)
- 3.4. 10% . Potassium iodide (m/v)
- 3.5. Concentrated hydrochloric acid (R)
- 3.6. 10% Hydrochloric acid (R)
- 3.7. Sodium borohydride (NaBH₄)
- 3.8. Sodium hydroxide (NaOH)
- 3.9. 0.6% Sodium borohydride (containing sodium hydroxide: 0.5% (m/v))
- 3.10. Calcium Chloride CaCl₂ (used as a drying agent)

**COMPENDIUM OF INTERNATIONAL METHODS OF ANALYSIS -
OIV**

Arsenic - Atomic absorption

3.11. 1 g/l Arsenic stock solution prepared in the following manner : dissolve 1.5339 g of As_2O_5 in demineralised water, adjust to 1 l.

3.12. 10 mg/l Arsenic solution: place 1 ml of stock solution (3.11.) in a 100 ml flask (2.1.1.) ; add 1 % nitric acid (3.2.) ; fill up to volume with demineralised water (3.1.).

3.13. 100 µg/l Arsenic solution: place 1 ml of 10 mg/l arsenic solution (3.12.) in a 100 ml flask (2.1.1.) ; fill up to volume with demineralised water (3.1.).

3.14. Set of calibration standards: 0, 5, 10, 25 µg/l
Successively place 0, 5, 10, 25 ml of 100 µg/l arsenic solution (3.13.) in 4 100 ml flasks (2.1.1.) ; add 10 ml of 10% potassium iodide to each flask (3.4.) and 10 ml of concentrated hydrochloric acid (3.5.) ; leave for 1 hour, fill up to 100 ml with demineralised water.

4. SAMPLE PREPARATION

25 ml of water is evaporated over a 100 °C water bath. This is then brought to 50 ml in the presence of 5 ml of 10% potassium iodide and 5 ml of concentrated hydrochloric acid; leave for 1 hour; filter on an ashless filter.

Make a blank reference sample.

5. DETERMINATION

The peristaltic pump sucks in the borohydride solution, the 10% hydrochloric acid solution and the sample solution.

Present the calibration standards in succession (3.14.); take an absorbency reading for 10 seconds; take two readings; the operating software establishes a calibration curve (absorbency according to concentration of arsenic in µg/l).

Then present the samples (4) ; the software establishes the sample's arsenic concentration in µg/l; deduct the arsenic concentration in the wine in µg/l taking into account that the solution be diluted by 1 / 2 .

6. QUALITY CONTROL

Quality control is assured by placing a control sample of internal quality (*) in a regular manner in 5 samples, or after the set of calibration solutions, or in the middle of a series or at the end the measurement.

Two deviation types are accepted compared to known value.

**COMPENDIUM OF INTERNATIONAL METHODS OF ANALYSIS -
OIV**

Arsenic - Atomic absorption

(*) Samples from the Bureau Communautaire de Référence (Community Bureau of reference): red wine, dry white wine and sweet white wine.

7. BIBLIOGRAPHY

Varian Techtron, 1972. Analytical methods for flame spectroscopy.

Hobbins B., 1982. Arsenic Determination by Hydride Generation. Varian Instruments at Work.

Le Houillier R., 1986. Use of Drierite Trap to Extend the Lifetime of Vapor Generation Absorption Cell. Varian Instruments at Work.

Varian, 1994. Vapor Generation Accessory VGA-77.

Arsenic

(A34 revised by OIV/OENO 377/2009)

1. Principle

After mineralization, using sulfuric and nitric acids, arsenic V is reduced to arsenic III by means of potassium iodide in hydrochloric acid and the arsenic is transformed into arsenic III hydride (H_3As) using sodium borohydride. The arsenic III hydride formed is carried by nitrogen gas and determined by flameless atomic absorption spectrophotometry at high temperature.

2. Method

2.1 Apparatus

2.1.1 Kjeldahl flask (borosilicate glass)

2.1.2 Atomic absorption spectrophotometer equipped with arsenic hollow cathode lamp, hydride generator, background corrector and a chart recorder.

The hydride generator includes a reaction flask (which can eventually be put onto a magnetic stirrer) connected by a tube to a nitrogen gas supply (flow rate: 11 L/min) and by a second tube, to a quartz cell which can be brought to a temperature of 900 °C. The reaction flask also has an opening for the introduction of the reagent (borohydride).

2.2 Reagents

All reagents must be of recognized analytically pure quality, and in particular free of arsenic. Double distilled water prepared using a borosilicate glass flask or water of similar purity should be used.

2.2.1 Sulfuric acid ($\rho_{20} = 1.84$ g/mL) arsenic free

2.2.2 Nitric acid ($\rho_{20} = 1.38$ g/mL) arsenic free

2.2.3 Hydrochloric acid ($\rho_{20} = 1.19$ g/mL), arsenic free

2.2.4 10% (*m/v*) Potassium iodide solution

**COMPENDIUM OF INTERNATIONAL METHODS OF ANALYSIS -
OIV
Arsenic**

2.2.5 2.5% (m/v) Sodium borohydride solution obtained by dissolving 2.5 g of sodium borohydride in 100 mL of 4 % (m/v) of sodium hydroxide solution. This solution must be prepared at the time of use.

2.2.6 Arsenic reference solution 1 g/L. Use of a commercial standard arsenic solution is preferred.

Alternatively this solution can be prepared in a 1000 mL volumetric flask, by dissolving 1.320 g of arsenic III trioxide As_2O_3 in a minimal volume of 20 % (m/v) sodium hydroxide. The solution is then acidified with hydrochloric acid, diluted 1/2, and made up to 1 liter with water.

2.3 Procedure

2.3.1 Mineralization

Place 20 mL of wine in a Kjeldahl flask, boil and reduce the volume by half to eliminate alcohol. Allow to cool. Add 5 mL sulfuric acid, and slowly add 5 mL nitric acid and heat. As soon as the liquid turns brown, add just enough nitric acid, dropwise, to lighten the liquid while simmering. Continue until the color clears and white sulfur trioxide fumes are formed above the solution.

Allow to cool, add 10 mL distilled water, bring back to the boil and simmer until nitrous oxide and sulfur trioxide fumes are no longer produced. Allow to cool and repeat the operation.

Allow to cool and dilute the sulfuric acid residue with a few milliliters of distilled water. Quantitatively transfer the solution into a 40 mL flask, and rinse the flask with water, combine with the diluted residue and make up to the mark with distilled water.

2.3.2 Determination

2.3.2.1 Preparation of the solution

Place 10 mL of the mineralization solution (2.3.1) into the hydride generator reactor flask. Add 10 mL hydrochloric acid, 1.5 mL potassium iodide solution, then switch on the magnetic stirrer and the nitrogen gas (flow rate: 11 L/minute). After 10 sec, add 5 mL of sodium borohydride solution. The hydride vapor obtained is immediately carried to the measurement cell (at a temperature of 900 °C) by nitrogen carrier gas, where dissociation of the compound and arsenic atomization occurs.

**COMPENDIUM OF INTERNATIONAL METHODS OF ANALYSIS -
OIV
Arsenic**

2.3.2.2 Preparation of standard solutions

From the arsenic reference solution (2.2.6), prepare dilutions having concentrations of 1, 2, 3, 4 and 5 micrograms of arsenic per liter respectively. Place 10 mL of each of the prepared solutions into the reactor flask of the hydride generator and analyze according to 2.3.2.1.

2.3.2.3 Measurements

Select an absorption wavelength of 193.7 nm. Zero the spectrophotometer using double distilled water and carry out all determinations in duplicate. Record the absorbance of each sample and standard solution. Calculate the average absorbance for each of these solutions.

2.4 *Expression of results*

2.4.1 Calculation

Plot the curve showing the variation in absorbance as a function of the arsenic concentration in the standard solutions. The relationship is linear. Note the average absorbance of the sample solutions on the graph and read the arsenic concentration C.

The arsenic concentration in wine, expressed in micrograms per liter is given by: $2 C$.

BIBLIOGRAPHY

JAULMES P. et HAMELLE G., *Trav. Soc. Pharm. Montpellier*, 1967, **27**, n^o 3, 213-225.

JAULMES P., *F.V., O.I.V.*, 1967, n^o 238

MEDINA B et SUDRAUD P., *F.V., O.I.V.*, 1983, n^o 770.

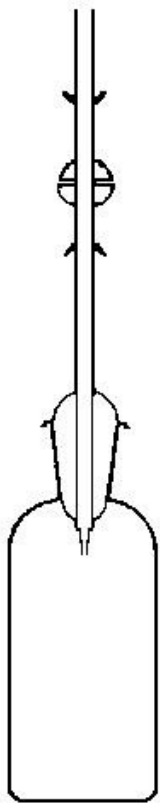

Fig.1: Apparatus used in the limit test of arsenic

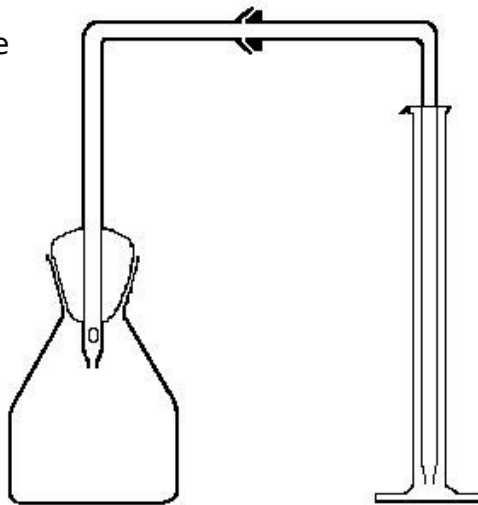

Fig 2: Apparatus used in the determination of arsenic

Method OIV-MA-AS323-01C

Arsenic

(A34; OIV/OENO 377/2009)

1. Principle

After mineralization using sulfuric and nitric acids, arsenic V is reduced to arsenic III using tin II chloride. The arsenic is then converted into arsenic III hydride by the action of the hydrogen produced. Arsenic III hydride is detected by reaction with mercury II bromide (limit sample).

WITHDRAWN

**Quantification of total nitrogen according
to the Dumas method**

(Musts and Wines)

(OENO 13/2002 revised by OIV/OENO 377/2009)

1 - FIELD OF APPLICATION

This method can be applied to the analysis of total nitrogen in musts and wine within the range of 0 to 1000 mg/l.

2 - DESCRIPTION OF THE TECHNIQUE

2.1 - Principle of the Dumas method

The analysis of total nitrogen in an organic matrix can be carried out using the Dumas method (1831). This involves a total combustion of the matrix under oxygen. The gases produced are reduced by copper and then dried, while the CO₂ is trapped. The nitrogen is then quantified using a universal detector.

2.2 - Principle of the analysis (Figure n° 1)

- Injection of the sample and oxygen in the combustion tube at 940°C (1) ;
- « Flash » Combustion (2) ;
- The combustion of the gathering ring (3) brings the temperature temporarily up to 1800°C ;
- Complementary oxidation and halogen trappings on silver cobalt and granular chromium sesquioxide (4) ;
- Reduction of nitrogen oxides in N₂ and trapping sulphur components and excess oxygen by copper at 700°C (5) ;
- Gases in helium include: N₂, CO₂ and H₂O (6) ;
- Trapping unmeasured elements: H₂O using anhydron (granular anhydrous magnesium perchlorate) (7) and CO₂ by ascarite (sodium hydroxide on silica) (8) ;
- Chromatography separation of nitrogen and methane possibly present following very large trial uptake (9) ;
- Catharometer detection (10) ;
- Signal gathering and data processing (11).

**COMPENDIUM OF INTERNATIONAL METHODS OF ANALYSIS -
OIV**

Total nitrogen (Dumas method)

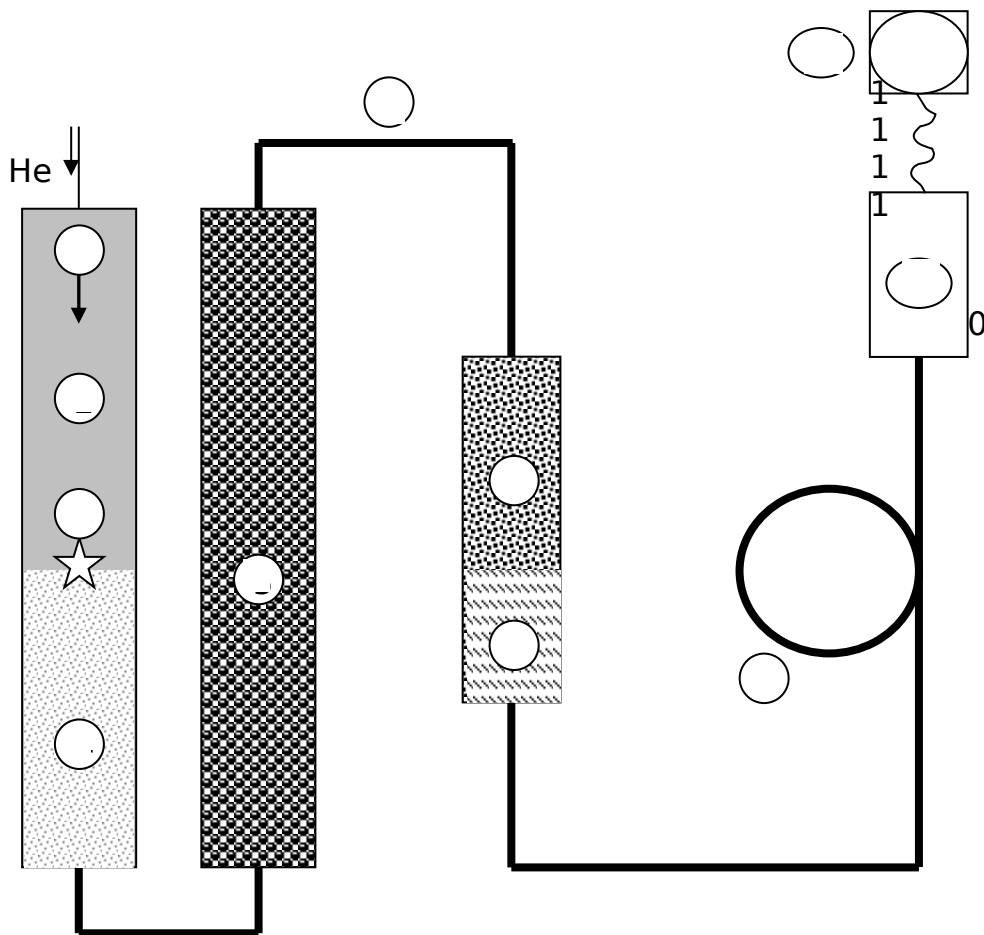
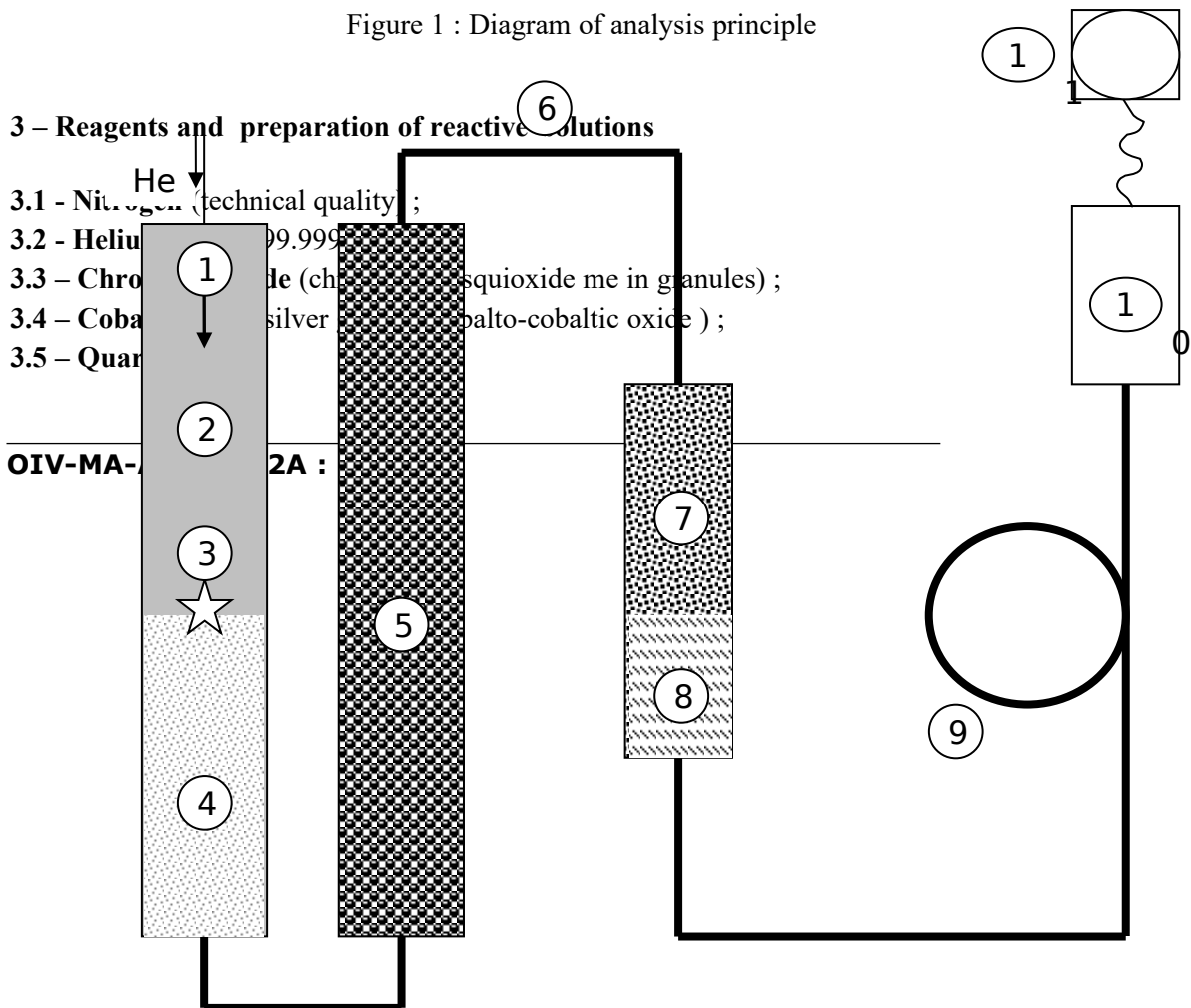

Figure 1 : Diagram of analysis principle



**COMPENDIUM OF INTERNATIONAL METHODS OF ANALYSIS -
OIV**

Total nitrogen (Dumas method)

- 3.6 - **Copper** (reduced copper in strings) ;
- 3.7 - **Ascarite** (sodium hydroxide on silica) ;
- 3.8 - **Anhydron** (granular anhydrous magnesium perchlorate) ;
- 3.9 - **Oxygen** (purity 99.995%) ;
- 3.10 - **Atropine** ;
- 3.11 – **Glumatic-hydric chloride acid**;
- 3.12 – **Demineralised water**;
- 3.13 – **Tin boat**.

4 - Apparatus

- 4.1 - **Centrifuge** with 25 ml pots;
- 4.2 – **Nitrogen analyser**;
- 4.3 – **Metallic crucible**;
- 4.4 - **Quartz reaction tube** (2) ;
- 4.5 – **Precision balance** between 0.5 mg and 30 g at ± 0.3 mg ;
- 4.6 – **Boat carrier**;
- 4.7.- **Furnace**;
- 4.8 – **Apparatus for folding boats**;
- 4.9 – **Sample changer**;
- 4.10 – **Computer and printer**.

5 - SAMPLING

Degas by nitrogen bubbling (3.1) for 5 to 10 mn, sparkling wine. The musts are centrifuged (4.1) for 10 mn at 10°C, at 4200 g.

6 – OPERATING INSTRUCTIONS

- Open the apparatus programme (4.2 and 4.10) ;
- Put the heating on the apparatus (4.2).

6.1 – Principle analytical parameters

Nitrogen analyser (4.2) under the following conditions:

- gas carrier: helium (3.2) ;
- metallic crucible (4.3) to be emptied every 80 analyses ;
- oxidation tube (4.4), heated to 940° C, containing chromium oxide (3.3) and cobalt oxide(3.4) held back by quartz wool (3.5). The tube and reagent set must be changed every 4000 analyses ;

**COMPENDIUM OF INTERNATIONAL METHODS OF ANALYSIS -
OIV**

Total nitrogen (Dumas method)

- reduction tube (4.4), heated to 700° C, containing copper (3.6) held back by the quartz wool (3.5). The copper is changed every 450 analyses;
- absorption tube, containing 2/3 of ascarite (3.7) and 1/3 anhydron (3.8). the ascarite which is taken in block is eliminated and replaced every 200 analyses. The absorbers are completely changed once a year.
- The more organic matter to be burned, the more oxygen is needed: the oxygen sampling valve (3.9) is 15 seconds for musts and 5 seconds for wine.

NOTE : The metals are recuperated and sent to a centre for destruction or specialised recycling.

6.2 - Preparation of standard scale

Prepare two samples of atropine (3.10) between 4 to 6 mg. Weigh them (4.5) directly with the boat. The calibration scale goes through 3 points (origin = empty boat).

6.3 – Preparation of internal standards

Internal standards are used regularly in the beginning and in the middle of analyses.

- Internal checks are carried out using glutamic acid in the form of hydrochloride at 600 mg N/l in demineralised water (3.12).

Molar mass of glutamic acid = 183.59

Molar mass of nitrogen = 14.007

$$\frac{183.59 \times 0.6}{14.007} = 7.864 \text{ g/l}$$

- Weigh (4.5) 7.864 g of glutamic acid (3.11) and dilute in demineralised water (3.12) qsp/l, to obtain a 600 mg N/l solution. This solution is diluted by 50% to obtain a 300 mg N/l solution, which is diluted by 50% again to obtain 150 mg/l solution.

**COMPENDIUM OF INTERNATIONAL METHODS OF ANALYSIS -
OIV**

Total nitrogen (Dumas method)

6.4 - Preparation of samples:

- 6.4.1 – In a boat (3.13), weigh (to the nearest 0.01 mg) 20 µl of must or 200 µl of wine with a precision balance (4.5). Repeat this procedure three times per sample;
- 6.4.2 – Write down the mass
- 6.4.3 – Place the boats progressively in the boat carrier (4.6) ;
- 6.4.4 – Place the boats in the furnace (4.7) set at $\simeq 60^{\circ}$ C, until the liquid has completely evaporated (this requires at least one hour) ;
- 6.4.5 – Fold and crush the boats with an appropriate apparatus (4.8), put them in the changer (4.9) in number order.

7 - EXPRESSION OF RESULTS

Results are expressed in g/l to the fourth decimal.

8 – CHECKING RESULTS

Splicing by mass, temperature, and volume.

9- PERFORMANCE CHARACTERISTICS OF THE METHOD

Number of laboratories	Average contents	Repeatability	Reproductibility
11	591 mg/l	43 mg/l	43 mg/l

10 - BIBLIOGRAPHY

Dumas A. (1826) : Annales de chimie, 33,342.

Buckee G.K. (1994) : Determination of total nitrogen in Barley, Malt and Beer by Kjeldahl procedures and the Dumas combustion method. Collaborative trial. J. Inst. Brew., 100, 57-64.

**Quantification of total nitrogen according to the Dumas
method (musts and wines)**

(OENO 13/2002; OIV-OENO 683-2022)

1. Field of application

This method applies to the analysis of total nitrogen in musts and wine up to 1000 mg/L.

2. Principle

The analysis of total nitrogen in an organic matrix can be carried out using the Dumas method. This involves the total combustion of the matrix in the presence of oxygen at a temperature higher than 900°C, followed by an additional oxidation. The nitrogen oxides are then reduced in dinitrogen, which is quantified using a thermal conductivity detector (katharometer), after elimination of the other oxides, water traces and carbon dioxide.

The nature and positioning of the traps varies according to the type of material.

3. Reagents and materials

- 3.1. Nitrogen (technical quality)
- 3.2. High-purity helium for GC (e.g. H₂O ≤ 3 ppm; O₂ ≤ 2 ppm; CnHm ≤ 1 ppm; N₂ ≤ 5 ppm)
- 3.3. High-purity oxygen for GC (e.g. H₂O ≤ 3 ppm; Ar ≤ 3 ppm; CnHm ≤ 0,2 ppm; N₂ ≤ 5 ppm)
- 3.4. Demineralised water (e.g. ISO 3696 type I or HPLC grade)
- 3.5. Oxidant (e.g. copper oxide [1317-38-0], chromium sesquioxide [1308-38-9] or silvered cobaltous/cobaltic oxide [1308-06-1])
- 3.6. Reducer (e.g. copper [7440-50-8])
- 3.7. Dehydrating agents (e.g. sodium hydroxide on silica or mixed with quartz crystals [1310-73-2], anhydrous magnesium perchlorate [10034-81-8] or calcium sulfate [7778-18-9])
- 3.8. Product for calibration range (e.g. tris(hydroxymethyl)aminomethane [77-86-1] or atropine [51-55-8])
- 3.9. Internal standard (e.g. glutamic acid hydrochloride [138-15-8], or a sample from an inter-laboratory proficiency-testing programme)

4. Apparatus

- 4.1. Centrifuge
- 4.2. ultrasonic bath
- 4.3. Total nitrogen analyser optionally equipped with a sample changer
- 4.4. Precision balance with precision of ± 0.01 mg between 0.5 mg and 30 g

5. Sampling

If the sample contains a significant amount of carbon dioxide, degas for example by bubbling nitrogen (3.1) for 5 to 10 min or by using an ultrasound bath. For musts, centrifuge (4.1).

6. Procedure

- 6.1. Preparation of the calibration range (given by way of example)

From a 1 g N/L solution, prepare five samples of TRIS (3.8) at 800, 500, 250, 100 and 50 mg N/L. The calibration curve therefore passes through seven points, from a blank to the 1 g N/L solution and follows a linear model. It is recorded in the instrumental method. Analyse the 500 mg N/L standard before starting each analytical sequence, and as soon as necessary to adjust the analyser.

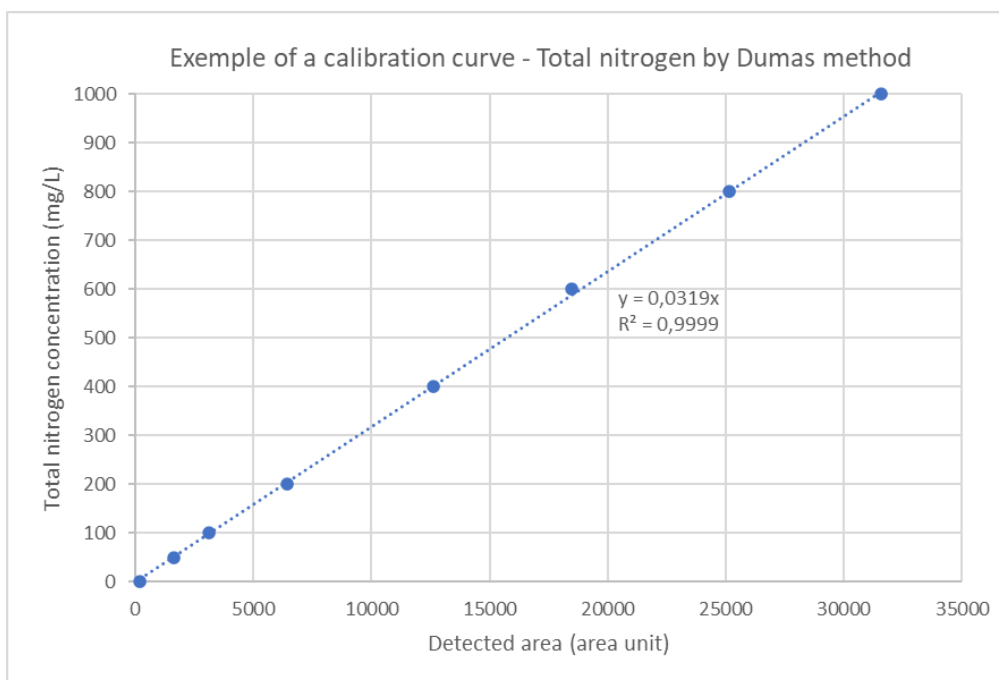

6.2. Preparation of control samples (given by way of example)

Control samples are used regularly at the beginning and in the middle of analysis series. They can be made up using the hydrochloride form of glutamic acid (3.9) at 150, 300 and 600 mg N/L in demineralised water (3.4).

$$C_{\text{glutamic acid}} = \frac{M_{\text{glutamic acid}} \times C_N}{M_N}$$

With :

$C_{\text{glutamic acid}}$ the glutamic acid concentration in the solution, expressed in g/L

C_N the nitrogen concentration in the solution, expressed in g/L

$M_{\text{glutamic acid}}$ the molar mass of glutamic acid. $M_{\text{glutamic acid}} = 183,59$ g/mol

M_N the molar mass of nitrogen. $M_N = 14,007$ g/mol

COMPENDIUM OF INTERNATIONAL METHODS OF ANALYSIS - OIV
Total nitrogen (Dumas method)

Weigh (4.4) 7.864 g of glutamic acid (3.9) and dilute in demineralised water (3.4) and make up to 1 L to obtain a 600 mg N/L solution. Dilute by 50% by transferring 250 mL of this solution and diluting to 500 mL to obtain a 300 mg N/L solution. Repeat with 250 mL of the 300 mg N/L solution to 500 mL to obtain a 150 mg N/L solution.

6.3. Preparation of samples

Weigh (to the nearest 0.01 mg) the volume defined for the analysis of the must or wine with the precision balance (4.4). Place the samples on the analyser awaiting analysis.

6.4. Analysis of samples

Carry out the analyses of samples and standards as per instrument manufacturer's instructions.

7. Expression of results

The results are expressed in mg/L of nitrogen, rounded to the nearest whole number.

8. Precision

Number of laboratories	Average contents	Repeatability r	Reproducibility R
11	591 mg/L	43 mg/L	153 mg/L

9. Bibliography

- DUMAS, A.: *Annales de chimie*, vol. 33, 1826, p.342.
- Buckee, G. K.: *Determination of total nitrogen in Barley, Malt and Beer by Kjeldahl procedures and the Dumas combustion method*, Collaborative trial. J. Inst. Brew., vol. 100, 1994, pp. 57-64.
- ISO 3696: Water for analytical laboratory use — Specification and test methods.

COMPENDIUM OF INTERNATIONAL METHODS OF ANALYSIS - OIV
Total nitrogen (Dumas method)

- Instrument manufacturer's instruction manual, or equivalent.

Boron

Rapid Colorimetric Method

(A44 revised by OIV/OENO 377/2009)

1. Principle

The alcohol content of the wine is removed by reducing the volume by half by rotary evaporation. The wine is then passed through a column of polyvinylpyrrolidone, which retains the coloring agents. The eluate is collected quantitatively and the boron concentration determined by complexation with azomethine H at pH 5.2 followed by spectroscopic analysis at 420 nm.

2. Apparatus

- 2.1. Rotary evaporator
- 2.2. Spectrophotometer capable of measuring absorbance wavelengths between 300 and 700 nm
- 2.3. Cells of 1 cm optical path
- 2.4. Glass column of 1 cm internal diameter and 15 cm in length containing an 8 cm layer of polyvinylpyrrolidone.

3. Reagents

- 3.1. Azomethin H (4-hydroxy-5-(2-hydroxybenzylideneamino)-2,7-naphthalenedisulfonic acid)
- 3.2. Azomethin H solution
Place 1 g of azomethin H and 2 g of ascorbic acid in a 100 mL volumetric flask and add 50 mL double distilled water. Warm slightly to dissolve and make up to the mark with double distilled water. The reagent is stable for 2 days if kept cold.
- 3.3. Buffer solution pH 5.2
Dissolve 3g of EDTA (disodium salt of ethylenediaminetetraacetic acid) in 150 mL of double distilled water. Add 125 mL acetic acid ($r_{20} = 1.05$ g/mL) and 250 g of ammonium acetate, $\text{NH}_4\text{CH}_3\text{COO}$, and dissolve. Check the pH with a pH meter and adjust if necessary to pH 5.2.

**COMPENDIUM OF INTERNATIONAL METHODS OF ANALYSIS -
OIV
Boron**

3.4. Boron stock standard solution, 100 mg/L

Use of a commercial standard solution is preferable. Alternatively this solution can be prepared by dissolving 0.571 g of boric acid, H_3BO_3 , dried beforehand at 50 °C until constant weight, in 500 mL double distilled water and made up to 1 liter.

3.5. Boron standard solution, 1 mg/L

Dilute the stock solution, 100 mg/L (3.4) 1/100 with double distilled water.

3.6. Polyvinylpolypyrrolidone or PVPP (see International Enological Codex)

4. Procedure

Eliminate alcohol from 50 mL of wine by concentration to half the original volume in a rotary evaporator at 40°C and make up to 50 mL with double distilled water.

Take 5 mL of this solution and pass it through the PVPP column (2.4). The coloring agents are completely retained. Collect the eluate and the rinsing waters from the column and place in a 50 mL volumetric flask and make up to the mark with water.

The colorimetric determination is performed in a volume of 5 mL of eluent placed in a 25 mL volumetric flask; dilute to approximately 15 mL with double distilled water and add the following (stirring after each addition):

5 mL of azomethin H solution (3.2)

4 mL of pH 5.2 buffer solution (3.3)

Make up to 25 mL with double distilled water.

Wait 30 min and determine the absorbance A_s , at 420 nm. The zero of the absorbance scale is set using distilled water.

Use a blank consisting of 5 mL of azomethin H solution and 4 mL of pH 5.2 buffer solution in 25 mL of double distilled water. Wait 30 min and read the absorbance A_b under the same conditions. The absorbance must be between 0.20 and 0.24; a higher absorbance demonstrates boron contamination in the water or the reagents.

Preparation of the calibration curve

In 25 mL volumetric flasks, place 1 to 10 g of boron, corresponding to 1 to 10 mL of boron standard solution 1 mg/L (3.5) and continue as indicated in 4.0. The calibration graph representing the net absorbance ($A_s - A_b$) in relation to the concentration is a straight line passing through the origin.

Where: A_s = absorbance of sample

A_b = absorbance of blank

**COMPENDIUM OF INTERNATIONAL METHODS OF ANALYSIS -
OIV
Boron**

5. Calculations

The μg of boron contained in 5 mL of eluate, (corresponding to 0.5 mL of wine) obtained from interpolating the net absorbance values of ($A_s - A_b$) on the calibration graph is E. The content, B, in milligrams of boron per liter is given by:

$$B \text{ mg/L} = \frac{E}{0.5}$$

BIBLIOGRAPHY

WOLF B., *Soil Science and Plant Analysis*, 1971, **2**(5), 363-374 et 1974, **5**(1), 39-44.
CHARLOT C. and BRUN S., *F.V., O.I.V.*, 1983, n^o771.

Sulfur dioxide

A17, revised by OIV/OENO 377/2009

OIV-OENO 591A-2018

OIV-OENO 661-2022

1. Definitions

Free sulfur dioxide is defined as the sulfur dioxide present in the must or wine in the following forms: H_2SO_3 , HSO_3^- , whose equilibrium as a function of pH and temperature is:

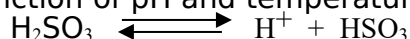

H_2SO_3 represents molecular sulfur dioxide.

Total sulfur dioxide is defined as the total of all the various forms of sulfur dioxide present in the wine, either in the free state or combined with their constituents.

2. Free and Total Sulfur Dioxide

2.1 Principle

Free sulfur dioxide is carried over by a stream of air or nitrogen and is fixed and oxidized by bubbling through a dilute and neutral solution of hydrogen peroxide. The sulfuric acid formed is determined by titration with a standard solution of sodium hydroxide. Free sulfur dioxide is purged from the wine by entrainment at low temperature (10 °C).

Total sulfur dioxide is purged from the wine by entrainment at high temperature (approximately 100 °C).

2.2 Method

2.2.1 Apparatus

The apparatus to be used should conform to the diagram overleaf, especially with regard to the condenser (see Fig 1).

The gas supply tube to the bubbler B ends in a small sphere of 1 cm diameter with 20 holes 0.2 mm in diameter around its largest horizontal circumference. Alternatively, this tube may end in a sintered glass plate that produces a large number of very small bubbles and thus ensures good contact between the liquid and gaseous phases.

The gas flow through the apparatus should be approximately 40 L/h. The bottle situated on the right of the apparatus is intended to restrict the pressure reduction produced by the water pump to 20 - 30 cm water. In order to regulate the flow rate, a flow meter with a semi-capillary tube should be installed between the bubbler and the bottle.

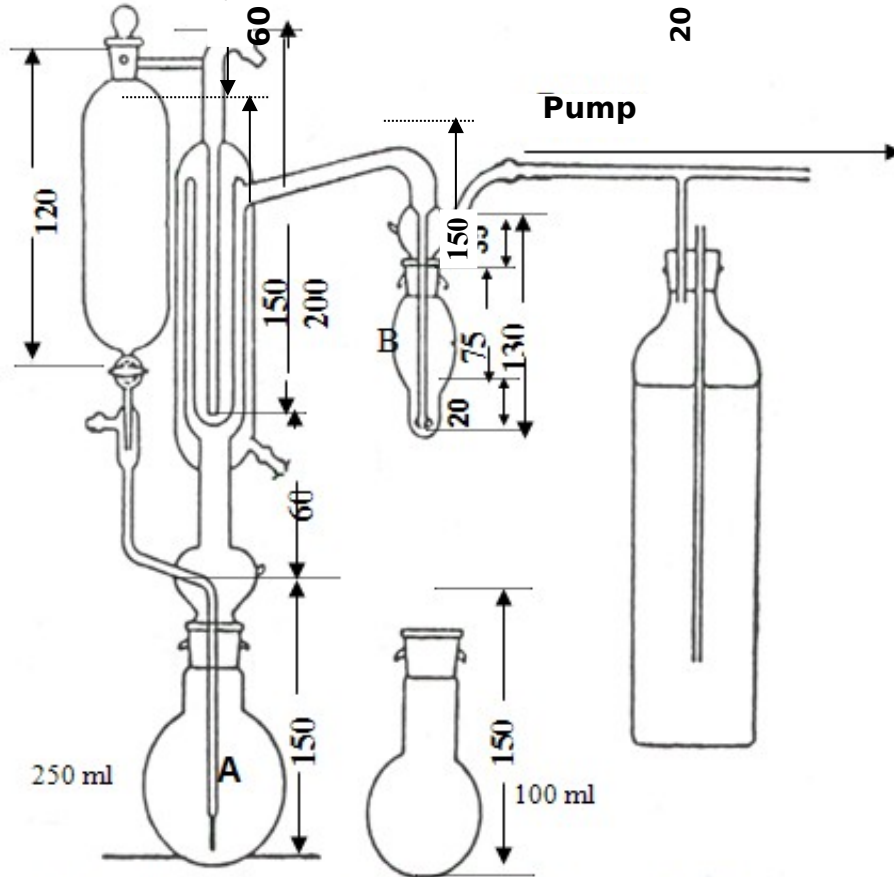

FIGURE 1: The dimensions are given in millimeters. The internal diameters of the 4 concentric tubes making up the

2.2.2 Reagents

2.2.2.1 Phosphoric acid: phosphoric acid 85% ($r_{20} = 1.71$ g/mL),

**COMPENDIUM OF INTERNATIONAL METHODS OF ANALYSIS -
OIV
Sulfur dioxide**

2.2.2.2 Hydrogen peroxide solution, 9.1 g H₂O₂/L (3 volumes)

2.2.2.3 Indicator reagent:

Methyl Red	100 mg
Methylene Blue	50 mg
Ethanol 50% (v/v)	100 mL

2.2.2.4 0.01 M Sodium hydroxide solution

2.2.3 *Determination of free sulfur dioxide content.*

The wine must be maintained at 20°C in a full and stoppered flask for 2 days before determination.

2.2.3.1 Procedure

- Place 50 mL of the sample and 15 mL of phosphoric acid (2.2.2.1) into the 250 mL flask (A) of the entrainment apparatus. Connect the flask into the apparatus.
- In the bubbler (B), place 2 or 3 mL of hydrogen peroxide solution (2.2.2.2), two drops of the indicator reagent (2.2.2.3) and neutralize the hydrogen peroxide solution with the 0.01 M sodium hydroxide solution. (2.2.2.4) Connect the bubbler to the apparatus.

Bubble air (or nitrogen) through the apparatus for 15 minutes. Free sulfur dioxide carried over is oxidized to sulfuric acid. Remove the bubbler from the apparatus and titrate the acid which has formed with the 0.01 M sodium hydroxide solution (2.2.2.4).

Let n mL be the volume used.

2.2.3.2 Expression of results

The liberated sulfur dioxide is expressed in mg/L to the nearest whole number.

2.2.3.2.1 Calculation

If n is the number of mL of 0.01 M sodium hydroxide solution, used, the amount of free sulfur dioxide in milligrams per liter is given by: $6.4 n$

2.2.4 Determination of total sulfur dioxide content.

2.2.4.1 Procedure

- Samples having a SO₂ content ≤50 mg/L of total SO₂:

**COMPENDIUM OF INTERNATIONAL METHODS OF ANALYSIS -
OIV
Sulfur dioxide**

Place 50 mL of the sample and 15 mL of phosphoric acid (2.2.2.1) into the 250 mL round-bottom vacuum flask (A). Connect the flask to the apparatus.

Remark: In the case of must, proceed with the method of operation described in the 1978 edition of the Compendium (see page 367).

- Samples with a content ≥ 50 mg/L of total SO₂:

Place 20 mL of the sample and 5 mL phosphoric acid (2.2.2.1) into the 250 mL round-bottom vacuum flask A. Connect the flask to the apparatus.

Place in the bubbler B, 2 or 3 mL of the hydrogen peroxide solution (2.2.2.2), neutralized as before, and bring the wine in the flask A to a boil using a small flame of 4 or 5 cm height which should directly touch the bottom of the flask. Do not place the flask on a metal cloth, but on a mantle with a hole 30 mm in diameter in it. This is to avoid overheating substances extracted from the wine that are deposited on the walls of the flask.

Maintain boiling while passing a current of air (or nitrogen). Within 15 minutes the total sulfur dioxide is carried over and oxidized. Determine the sulfuric acid formed by titration with 0.01 M sodium hydroxide solution. (2.2.2.4).

Let n be the volume used.

2.2.4.2 Expression of results.

2.2.4.2.1 Calculation

Total sulfur dioxide in milligrams per liter:

- Samples low in sulfur dioxide (50 mL test sample): $6.4 \cdot n$
- Other samples (20 mL test sample): $16 \cdot n$

2.2.4.3 Repeatability (r):

- (< 50 mg/L) 50 mL test sample, $r = 1$ mg/L
- (> 50 mg/L) 20 mL test sample, $r = 6$ mg/L

2.2.4.4 Reproducibility (R):

- (< 50 mg/L) 50 mL test sample, $R = 9$ mg/L
- (> 50 mg/L) 20 mL test sample, $R = 15$ mg/L

BIBLIOGRAPHY

Reference method

PAUL F., *Mitt. Klosterneuburg, Rebe u. Wein*, 1958, ser. A, 821.

Free sulphur dioxide

A17 revised by OIV/OENO 377/2009

OIV-OENO 591A-2018

OIV-OENO 661-2021

1 Scope

This method is for the determination of free sulphur dioxide in wine and must.

2 Definitions

Free sulphur dioxide is defined as the sulphur dioxide present in the must or wine in the following forms: H_2SO_3 and HSO_3^- , whose equilibrium is dependent on pH and temperature:

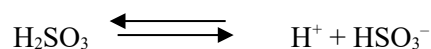

H_2SO_3 represents the molecular sulphur dioxide.

3 Principle

Sulphur dioxide is entrained by a current of air or nitrogen, and is fixed and oxidised by bubbling through a dilute and neutral solution of hydrogen peroxide. The sulphuric acid formed is determined by titration with a standard solution of sodium hydroxide.

The quantity of sulphur dioxide entrained being strongly temperature dependent, the decision was made to work at room temperature (between 18 and 24 °C). This temperature, as for that of the currents of air or nitrogen, should be kept constant throughout the determination.

4 Reagents and products

4.1 Pure phosphoric acid at 85% ($\rho_{20} = 1.71 \text{ g/mL}$) (CAS no. 7664-38-2)

4.2 Diluted phosphoric acid (~25.5%):

By way of example: Dilute 300 mL of phosphoric acid at 85% (4.1) in 1 L of water for analytical use

COMPENDIUM OF INTERNATIONAL METHODS OF ANALYSIS-OIV
Free sulphur dioxide

- 4.3 Indicator reagent:
- | | |
|---|-----------------------|
| Methyl red (CAS no. 493-52-7) | 100 mg (± 1 mg) |
| Methylene blue (CAS no. 7220-79-3) | 50 mg (± 0.5 mg) |
| Ethanol ($\geq 95\%$) (CAS no. 64-17-5) | 50 mL |
- Make up to 100 mL with water for analytical use. Respect the proportions for the volumes that differ from 100 mL.
Commercial indicator reagents with the same composition may be used.
- 4.4 1 M Sodium hydroxide (3.84%) or in anhydrous form (pellets) (CAS no. 1310-73-2)
- 4.5 0.01 M Sodium hydroxide solution:
By way of example: Dilute 10.0 mL of 1 M sodium hydroxide (4.4) in 1 L of water for analytical use.
If necessary, check the titre of the solution regularly (correction factor to be applied) and keep it away from atmospheric CO₂.
- 4.6 Hydrogen peroxide solution in 3 volumes (= 9.1 g/L = 0.27 mol/L H₂O₂), prepared or commercial (e.g. 30% H₂O₂: mixture with CAS no. 7722-84-1)
Note: A solution of 30% by mass corresponds to a titre of 110 volumes ($\rho_{20} \cong 1,11$ g/mL), implying the volume of oxygen ideally released per litre of H₂O₂ under standard conditions of temperature and pressure, while a solution of 3% by mass ($\rho_{20} \cong 1$ g/mL) corresponds to a titre of 10 volumes (0.89 mol/L). The preparation thus depends on the commercial solution used, considering that in any case the volume used in the method will be in excess.

5 Apparatus

The apparatus to be used should conform to the diagram below, especially with regard to the condenser.

The gas supply tube to bubbler B ends in a small sphere of 1 cm in diameter with 20 holes of 0.2 mm in diameter around its largest horizontal circumference. Alternatively, this tube may end in a sintered glass plate that produces a large number of very small bubbles and thus ensures good contact between the liquid and gaseous phases.

The gas flow through the apparatus should be approximately 40 L/h. The bottle situated on the right of the apparatus is intended to restrict the pressure reduction produced by the water pump to 20-30 cm water. In order to regulate the pressure reduction to achieve the proper flow rate, it is preferable to install a flow meter with a semi-capillary tube between the bubbler and the bottle.

Flask A should be kept at a temperature of between 18 °C and 24 °C throughout aspiration. Each flask should consequently be temperature-controlled (e.g. using a thermostatic bath) if the room temperature of the laboratory is not within these limits or if 85% phosphoric acid is used, which can significantly increase the temperature in the flask during addition.

OIV-MA-AS323-04A1

:

R2021

3



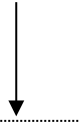

35
B

Figure 1 - The dimensions are indicated in millimetres. The internal diameters of the 4 concentric tubes that make the condenser are 45, 34, 27 and 10 mm.

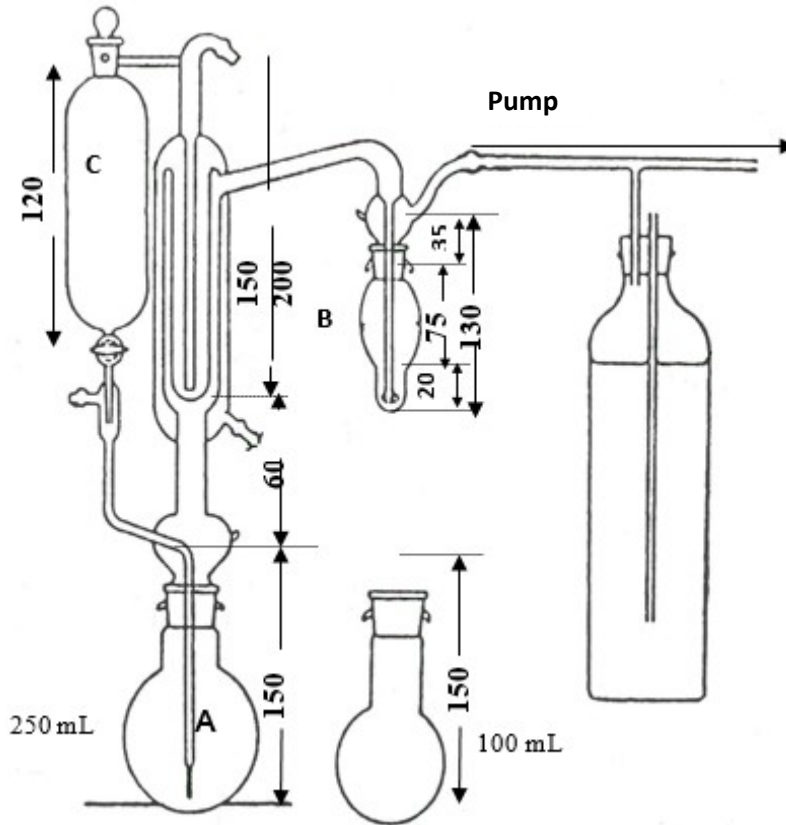

6

150

Procedure

Air- or nitrogen-rinsing the apparatus before each new determination (e.g. for 5 minutes) is recommended. If a blank test is carried out, the colour of the indicator in the neutralised hydrogen peroxide solution at the exit of the gas-supply tube should not change.

- Connect the water from the condenser.

COMPENDIUM OF INTERNATIONAL METHODS OF ANALYSIS-OIV
Free sulphur dioxide

- Control the laboratory temperature or stabilise the bath in advance (at between 18 °C and 24 °C).
- In bubbler B of the entrainment apparatus, introduce 2-3 mL hydrogen peroxide solution (4.6) and 2 drops of indicator reagent (4.3), and neutralise with the 0.01 M sodium hydroxide solution (4.5); a neutral pH = green colour.
Note: For large sample series, it is also possible to prepare an already neutralised H₂O₂ solution before introducing it into the flask. Adapt the concentrations and volumes accordingly, bearing in mind that the oxidative power of the solution must be maintained (reduced shelf life).
- Adapt this bubbler to the apparatus.
- Transfer 50 mL of sample to the 250-mL flask A and attach it to the apparatus.
- Introduce 15 mL of diluted phosphoric acid (4.2) into bulb C.
- *Note:* If the expected concentration of free sulphur dioxide is higher than 50 mg/L, it is necessary to use phosphoric acid at 85% (4.1). However, ensure that the temperature in flask A does not increase during addition.
- Open the tap to add the acid to the sample while simultaneously starting the gas flow and setting the timer to 15 minutes. The entrained free sulphur dioxide is oxidised into sulphuric acid.
- After 15 minutes, take bubbler B out and rinse the gas supply tube in water (via the socket).
- Titrate the acid formed by the 0.01 M sodium hydroxide solution (4.5) up to the green bend.
- The number of millilitres used is expressed by n .

7 Calculation and expression of results

The free sulphur dioxide is expressed in milligrams per litre (mg/L), in whole numbers.

Calculation: Free sulphur dioxide in milligrams per litre: $6.4 n$

8 Bibliography

Paul, F., *Mitt. Klosterneuburg, Rebe u. Wein*, 1958, ser. A, 821.

Collaborative study
Method validation for the determination of free sulphur dioxide

1. Scope of application

An international collaborative study, in accordance with Resolution OIV-OENO 6-2000, for the validation of updates to the methods for the determination of free sulphur dioxide and total sulphur dioxide (OIV-MA-AS323-04A), based on the decision of the OIV “Methods of Analysis” Sub-Commission, April 2018.

2. Standard references

- Update (draft) to the OIV-MA-AS323-04A methods,
- ISO 5725,
- Resolution OIV-OENO 6-2000.

3. Protocol

A total of 20 samples were prepared using homogeneous volumes of 10 wines from various wine regions in France and Portugal. Each sample was made up twice (the second as a blind duplicate), according to the double-blind principle.

The samples were prepared between 18 and 20 June 2018, then shipped without delay to the participating laboratories.

Sample no.	Blind duplicate no.	Nature of sample
A	1-14	Dry white wine
B	2-16	Dry white wine
C	3-19	Dry rosé wine
D	4-12	Dry rosé wine
E	5-20	Dry red wine
F	6-18	Dry red wine
G	7-11	Dry red wine
H	8-15	White liqueur wine
I	9-17	Red liqueur wine
J	10-13	Red liqueur wine

COMPENDIUM OF INTERNATIONAL METHODS OF ANALYSIS-OIV
Free sulphur dioxide

The analyses were carried out simultaneously by all participating laboratories between 16 and 20 July 2018. Samples were kept in refrigerated cabinets by all laboratories between the date of reception and the date of analysis, according to the protocols sent.

The following laboratories provided their results:

Laboratory	City	Country
Estación de Viticultura e Enología de Galicia	Leiro (Ourense)	Spain
Laboratorio arbitral agroalimentario	Madrid	Spain
ASAE	Lisbon	Portugal
SCL Montpellier	Montpellier Cdex 5	France
HBLA und BA für Wein- und Obstbau	Klosterneuburg	Austria
Laboratorio de Salud Pública	Madrid	Spain
Laboratorio Agroambiental de Zaragoza	Zaragoza	Spain
Laboratoire SCL Bordeaux	Pessac Cedex - CS 98080	France
Unione Italiana Vini Servizi	Verona	Italy
Laboratorio Agroalimentario de Valencia	Burjassot (Valencia)	Spain
Agroscope	Nyon	Switzerland
Laboratoires Dubernet	Montredon des Corbières	France
Laboratoire Dioenos Rhône	Orange	France
Laboratoire Natoli	Saint Clément de Rivière	France

NB: The order of laboratories in the table does not correspond with the order in the following tables, in order to preserve the anonymity of results.

**COMPENDIUM OF INTERNATIONAL METHODS OF ANALYSIS-OIV
Free sulphur dioxide**

4. Free sulphur dioxide

4.1 Free SO₂ data

Free SO ₂ (mg/L)	A		B		C		D		E		F		G		H		I		J	
Sample	1	14	2	16	3	19	4	12	5	20	6	18	7	11	8	15	9	17	10	13
Labo 3			31	36	18	18	21	23	20	18	6	6	20	17	5	6				
Labo 5			37	35	21	24	24	25	20	20	8	7	20	20	3	4				
Labo 6	4	1	38	33	21	20	20	26	19	20	7	6	21	19	7	8	1	3	1	1
Labo 7	1	1	37	40	20	22	24	26	20	22	9	8	20	23	8	8	2	1	1	1
Labo 8			31	32	18	19	23	22	22	20	6	7	19	20	5	3	1	1		
Labo 9			35	34	23	19	25	24	21	24			17	17						
Labo 10	2	1	35	34	20	21	24	24	22	21	9	8	21	20	7	7	2	2	1	1
Labo 11	0	0	33	30	17	11	22	16	16	21	6	4	15	19	6	3	1	1	0	0
Labo 15			15	19	15	13	18	20	8	16	6	5	8	15	5	5				
Labo 17	0	0	37	38	24	26	28	28	26	23	8	8	24	22	7	7	1	2	0	0
Labo 18	0	4	33	31	21	11	23	27	15	19	6	4	9	20	3	4	1	1	0	0
Labo 20	0	0	32	32	20	19	21	21	29	21	8	8	20	18	12	4	1	1	0	0
Labo 21	2	1	33	38	19	15	25	22	19	21	6	6	19	20	8	7	2	1	0	0

Results left blank were rendered non-quantifiable (< limit of quantification).

	Result removed by the COCHRAN test at 5%
	Result removed by the GRUBBS test at 5%

COMPENDIUM OF INTERNATIONAL METHODS OF ANALYSIS-OIV
Free sulphur dioxide

4.2 Free SO₂ results

Free SO₂ (mg/L)	A	B	C	D	E	F	G	H	I	J
No. of laboratories selected	7	9	11	10	10	12	11	11	9	8
No. of repetitions	2	2	2	2	2	2	2	2	2	2
Min.	0	31.5	14	19	17	5	17	3.5	1	0
Max.	2.5	38.5	25	28	24.5	8.5	23	8	2	1
Mean	0.9	34.2	19.8	23.4	20.6	6.8	19.6	5.7	1.4	0.4
Standard deviation	0.98	2.67	2.91	2.46	2.04	1.31	1.77	1.72	0.42	0.52
Repeatability variance	0.79	1.67	2.59	1.20	2.60	0.58	2.23	0.82	0.39	0.00
Inter-laboratory standard deviation	0.98	2.67	2.91	2.46	2.04	1.31	1.77	1.72	0.42	0.52
Reproducibility variance	1.35	7.97	9.76	6.64	5.46	2.00	4.25	3.38	0.37	0.27
Repeatability standard deviation	0.89	1.29	1.61	1.10	1.61	0.76	1.49	0.90	0.62	0.00
r limit	2.48	3.61	4.51	3.07	4.51	2.14	4.18	2.53	1.75	0.00
Repeatability %CV (k=2)	191	8	16	9	16	23	15	32	90	0
Reproducibility standard deviation	1.16	2.82	3.12	2.58	2.34	1.41	2.06	1.84	0.61	0.52
R limit	3.25	7.90	8.75	7.22	6.54	3.96	5.78	5.15	1.70	1.45
Reproducibility %CV (k=2)	250	16	32	22	23	42	21	64	87	276
Horwitz PRSD _R (%)	16.18	9.40	10.21	9.95	10.15	12.00	10.22	12.30	15.23	18.55
Horwitz S _R	0.15	3.22	2.02	2.33	2.09	0.81	2.00	0.70	0.21	0.07
Horwitz R	0.42	9.10	5.71	6.59	5.91	2.29	5.67	1.99	0.60	0.20
Horwitz Ratio	7.64	0.87	1.53	1.10	1.11	1.73	1.02	2.58	2.84	7.37

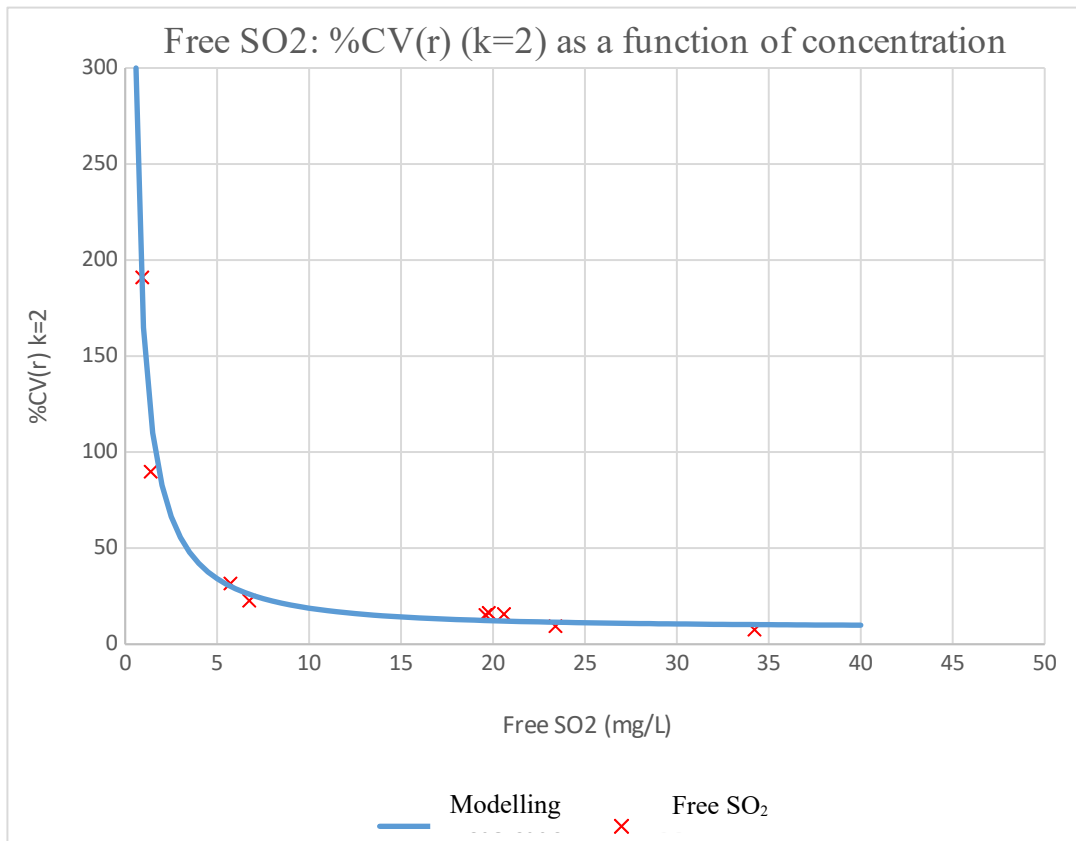

Figure 1: Modelling of the repeatability coefficient of variation, %CV(r) (k=2), as a function of the concentration, C:

$$\%CV(r) = \sqrt{\frac{164.55^2}{C^2} + 9^2}$$

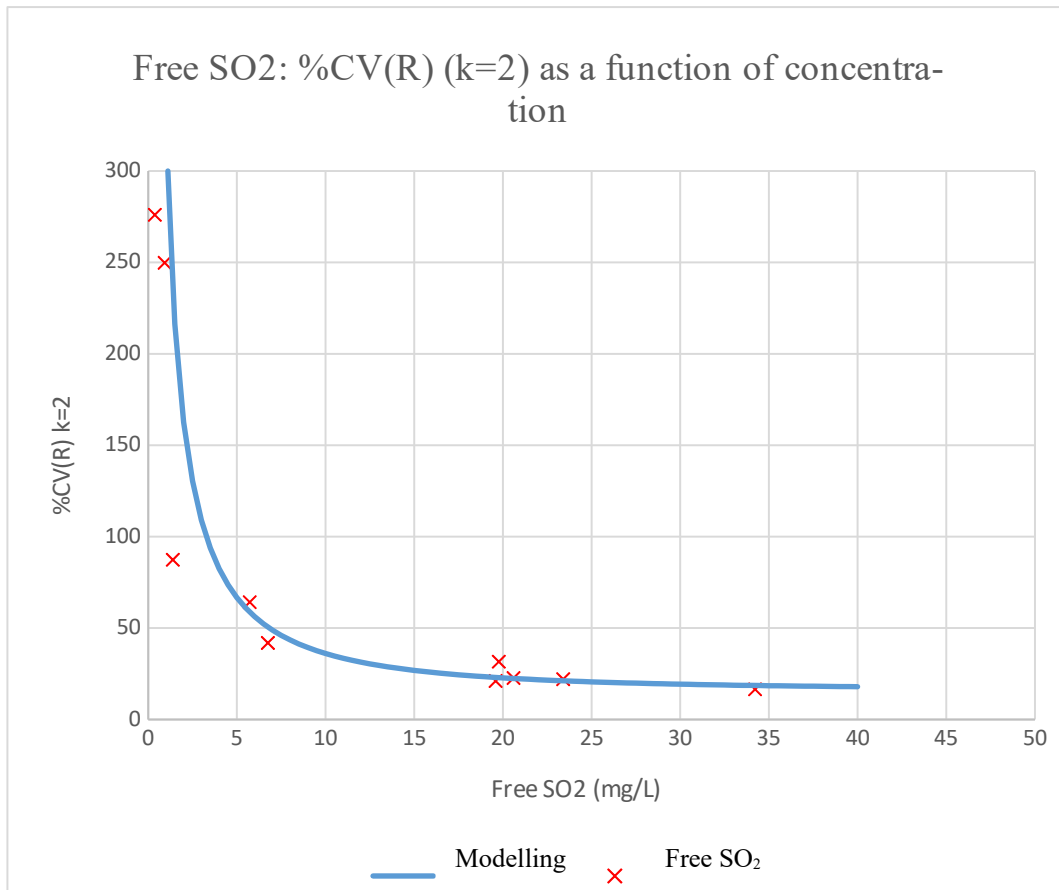

Figure 2: Modelling of the inter-laboratory reproducibility coefficient of variation, %CV(R) (k=2), as a function of concentration, C:

$$\%CV(R) = \sqrt{\frac{323.6^2}{C^2} + 16^2}$$

COMPENDIUM OF INTERNATIONAL METHODS OF ANALYSIS-OIV
Free sulphur dioxide

5. Total sulphur dioxide

5.1. Total SO₂ data

Total SO ₂ (mg/L)	A		B		C		D		E		F		G		H		I		J	
Sample	1	14	2	16	3	19	4	12	5	20	6	18	7	11	8	15	9	17	10	13
Labo 3			128	127	72	73	128	131	61	59	28	28	57	56	102	102	47	45		
Labo 5			122	121	68	71	112	114	42	53	22	22	51	42	102	101	35	34		
Labo 6		1	128	131	72	72	126	131	53	54	22	20	42	49	98	99	31	34	3	1
Labo 7	3	3	131	131	70	74	130	131	54	59	26	23	46	48	106	101	37	40	1	1
Labo 8	2	1	125	127	72	72	129	128	58	57	22	23	46	45	97	99	42	39	1	1
Labo 9			120	128	77	75	132	108	71	59	21	25	44	47	110	99	38	48		
Labo 10	2	2	130	130	74	76	130	130	61	61	28	32	55	56	103	104	43	44	3	4
Labo 11	4	3	119	125	71	74	118	118	39	40	18	21	45	41	89	94	26	38	2	2
Labo 14	3	3	129	128	72	72	127	129	58	58	32	29	50	49	102	101	42	41	3	4
Labo 15			134	136	76	78	134	136	60	58	39	27	52	61	110	106	51	50		
Labo 17	3	3	134	132	82	76	136	133	59	50	24	23	46	44	107	105	35	38	0	0
Labo 18	5	3	130	129	78	73	133	133	62	59	29	32	58	52	105	105	50	48	2	2
Labo 20	1	1	128	131	72	74	130	130	58	56	26	28	48	45	98	93	41	43	0	0
Labo 21		0	124	125	69	72	124	126	45	51	19	20	42	42	97	97	35	34	0	1

Results left blank were rendered non-quantifiable (< limit of quantification).

	Result removed by the COCHRAN test at 5%
	Result removed by the GRUBBS test at 5%

5.2 Total SO₂ results

Total SO ₂ (mg/L)	A	B	C	D	E	F	G	H	I	J
OIV-MA-AS323-04A1										
7										
							R2021			

COMPENDIUM OF INTERNATIONAL METHODS OF ANALYSIS-OIV
Free sulphur dioxide

No. of laboratories selected	7	12	13	13	8	13	10	13	12	9
No. of repetitions	2	2	2	2	2	2	2	2	2	2
Min.	1	121.5	69.5	113	53.5	19.5	42	91.5	32.5	0
Max.	3.5	135	77	135	61	30.5	56.5	108	50.5	3.5
Mean	2.4	128.8	73.0	128.0	58.3	24.7	47.6	100.9	40.8	1.5
Standard deviation	0.93	3.63	2.20	6.24	2.42	4.04	4.89	4.61	5.80	1.35
Repeatability variance	0.14	1.46	3.27	2.35	1.44	3.04	2.30	3.96	2.21	0.17
Inter-laboratory standard deviation	0.93	3.63	2.20	6.24	2.42	4.04	4.89	4.61	5.80	1.35
Reproducibility variance	0.94	13.93	6.49	40.11	6.57	17.84	25.03	23.28	34.72	1.90
Repeatability standard deviation	0.38	1.21	1.81	1.53	1.20	1.74	1.52	1.99	1.49	0.41
r limit	1.1	3.4	5.1	4.3	3.4	4.9	4.2	5.6	4.2	1.1
Repeatability %CV (k=2)	31	2	5	2	4	14	6	4	7	54
Reproducibility standard deviation	0.97	3.73	2.55	6.33	2.56	4.22	5.00	4.82	5.89	1.38
R limit	2.7	10.5	7.1	17.7	7.2	11.8	14.0	13.5	16.5	3.9
Reproducibility %CV (k=2)	80	6	7	10	9	34	21	10	29	184
Horwitz PRSD _R (%)	14.00	7.70	8.39	7.71	8.68	9.87	8.95	7.99	9.16	15.05
Horwitz s _R	0.34	9.92	6.13	9.86	5.06	2.44	4.26	8.06	3.73	0.23
Horwitz R	0.96	28.05	17.33	27.90	14.31	6.91	12.04	22.80	10.56	0.64
Horwitz Ratio	2.82	0.37	0.41	0.64	0.50	1.71	1.16	0.59	1.56	6.04

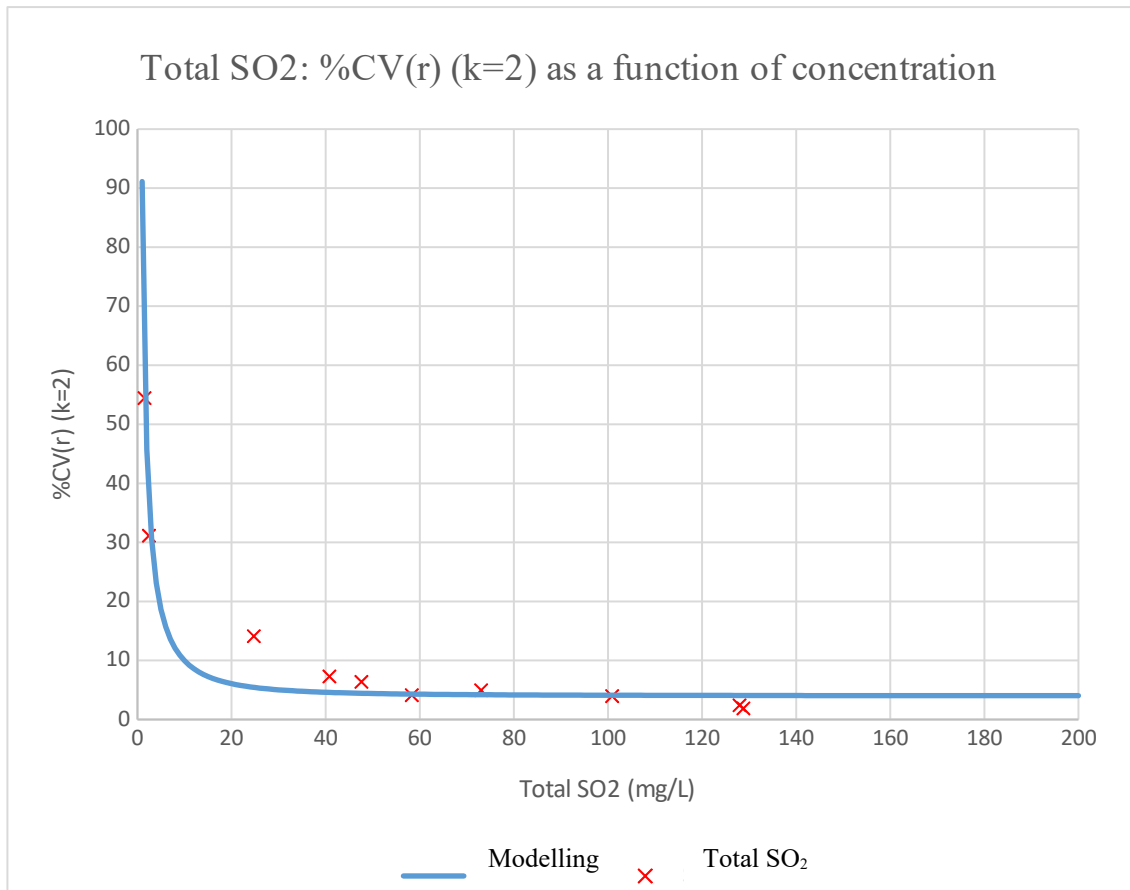

Figure 3: Modelling of the repeatability coefficient of variation, %CV(r) (k=2), as a function of concentration, C:

$$\%CV(r) = \sqrt{\frac{91^2}{C^2} + 4^2}$$

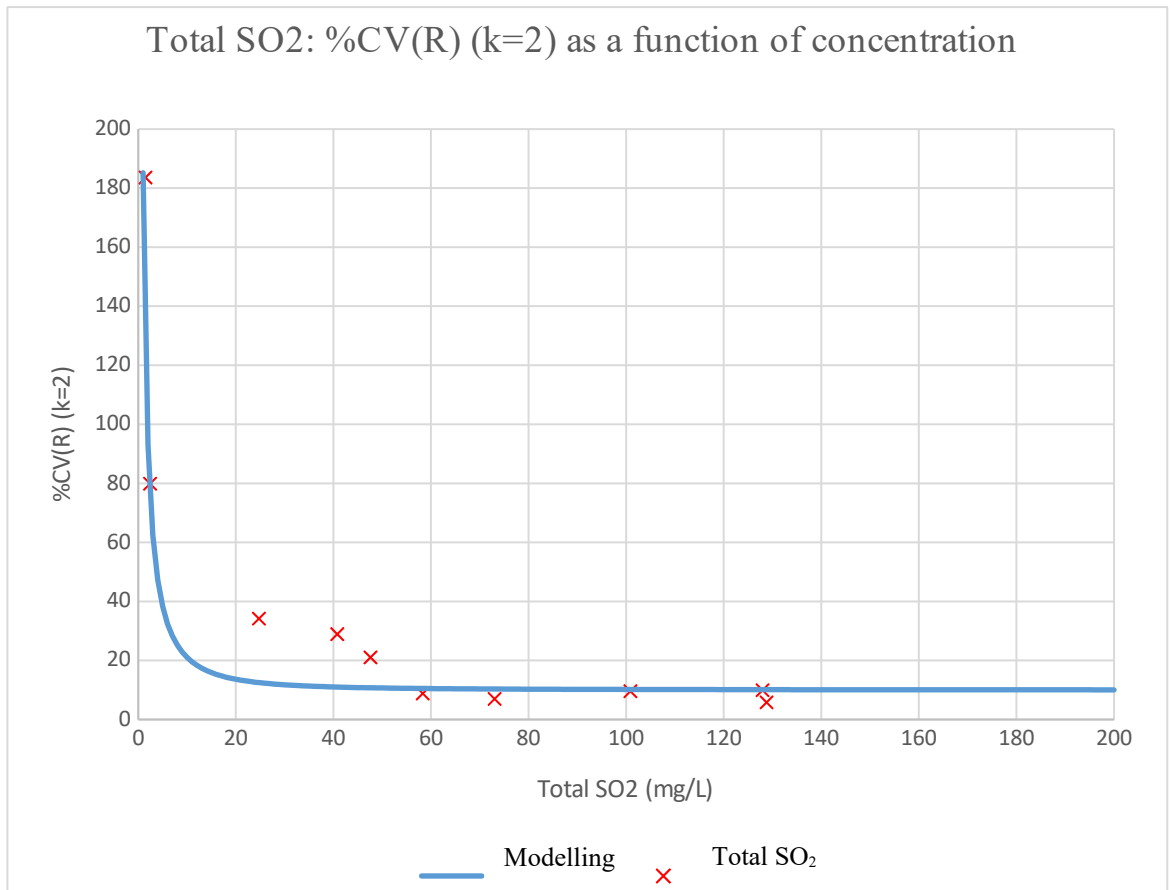

Figure 4: Modelling of the inter-laboratory reproducibility coefficient of variation, %CV_R (k=2), as a function of concentration, C:

$$\%CV(R) = \sqrt{\frac{184.9^2}{C^2} + 10^2}$$

Method OIV-MA-A323-04A2

Type II method

Total sulphur dioxide

A17 revised by OIV/OENO 377/2009:

OIV-OENO 591A-2018

OIV-OENO 661-2021

1 Scope

This method is for the determination of total sulphur dioxide in wine and must.

2 Definitions

Total sulphur dioxide is defined as the sum of all of the different forms of sulphur dioxide present in the wine in free form or bound to the wine's constituents.

3 Principle

Sulphur dioxide is aspirated by a current of air or nitrogen, and is captured and oxidised by bubbling through a dilute and neutral solution of hydrogen peroxide. The sulphuric acid formed is determined by titration with a standard solution of sodium hydroxide.

The total sulphur dioxide is extracted from the wine by aspiration at high temperature (around 100 °C).

4 Reagents and products

4.1 Pure phosphoric acid at 85% ($\rho_{20} = 1.71 \text{ g/mL}$) (CAS no. 7664-38-2)

4.2 Indicator reagent:

Methyl red (CAS no. 493-52-7) 100 mg ($\pm 1 \text{ mg}$)

Methylene blue (CAS no. 7220-79-3) 50 mg ($\pm 0.5 \text{ mg}$)

Ethanol ($\geq 95\%$) (CAS no. 64-17-5) 50 mL

Make up to 100 mL with water for analytical use. Respect the proportions for the volumes that differ from 100 mL.

Commercial indicator reagents with the same composition may be used.

4.3 1 M Sodium hydroxide (3.84%) or in anhydrous form (pellets) (CAS no. 1310-73-2)

4.4 0.01 M Sodium hydroxide solution:

OIV-MA-AS323-04A2

:

R2021

1

COMPENDIUM OF INTERNATIONAL METHODS OF ANALYSIS-OIV
Total sulphur dioxide

By way of example: Dilute 10.0 mL of 1 M sodium hydroxide (4.4) in 1 L of water for analytical use.

If necessary, check the titre of the solution regularly (correction factor to be applied) and keep it away from atmospheric CO₂.

- 4.5 Hydrogen peroxide solution in 3 volumes (= 9.1 g/L = 0.27 mol/L H₂O₂), prepared or commercial (e.g. 30% H₂O₂: mixture with CAS no. 7722-84-1)

Note: A solution of 30% by mass corresponds to a titre of 110 volumes ($\rho_{20} \cong 1,11$ g/mL), implying the volume of oxygen ideally released per litre of H₂O₂ under standard conditions of temperature and pressure, while a solution of 3% by mass ($\rho_{20} \cong 1$ g/mL) corresponds to a titre of 10 volumes (0.89 mol/L). The preparation thus depends on the commercial solution used, considering that in any case the volume used in the method will be in excess.

5 Apparatus

The apparatus to be used should conform to the diagram below, especially with regard to the condenser.

The gas supply tube to bubbler B ends in a small sphere of 1 cm in diameter with 20 holes of 0.2 mm in diameter around its largest horizontal circumference. Alternatively, this tube may end in a sintered glass plate that produces a large number of very small bubbles and thus ensures good contact between the liquid and gaseous phases.

The gas flow through the apparatus should be approximately 40 L/h. The bottle situated on the right of the apparatus is intended to restrict the pressure reduction produced by the water pump to 20-30 cm water. In order to regulate the pressure reduction to achieve the proper flow rate, it is preferable to install a flow meter with a semi-capillary tube between the bubbler and the bottle. For the determination of total sulphur dioxide, using a burner (with a 4-5 cm high flame or infrared) allowing for boiling point to be reached very quickly is preferable. Do not place a wire gauze under flask A, but rather a deflector with a 2-4 cm orifice. The pyrogenation of non-volatile matter in the wine on the flask walls is thus avoided.

Use a 250-mL flask for a 50 mL sample and a 100-150 mL flask for a 20 mL sample.

6 Procedure

Air- or nitrogen-rinsing the apparatus before each new determination (e.g. for 5 minutes) is recommended. If a blank test is carried out, the colour of the indicator (figure 1) is recommended. The dimensions are indicated in millimetres. The internal diameters of the 4 concentric tubes that make up the condenser are 45, 34, 27 and 10 mm.

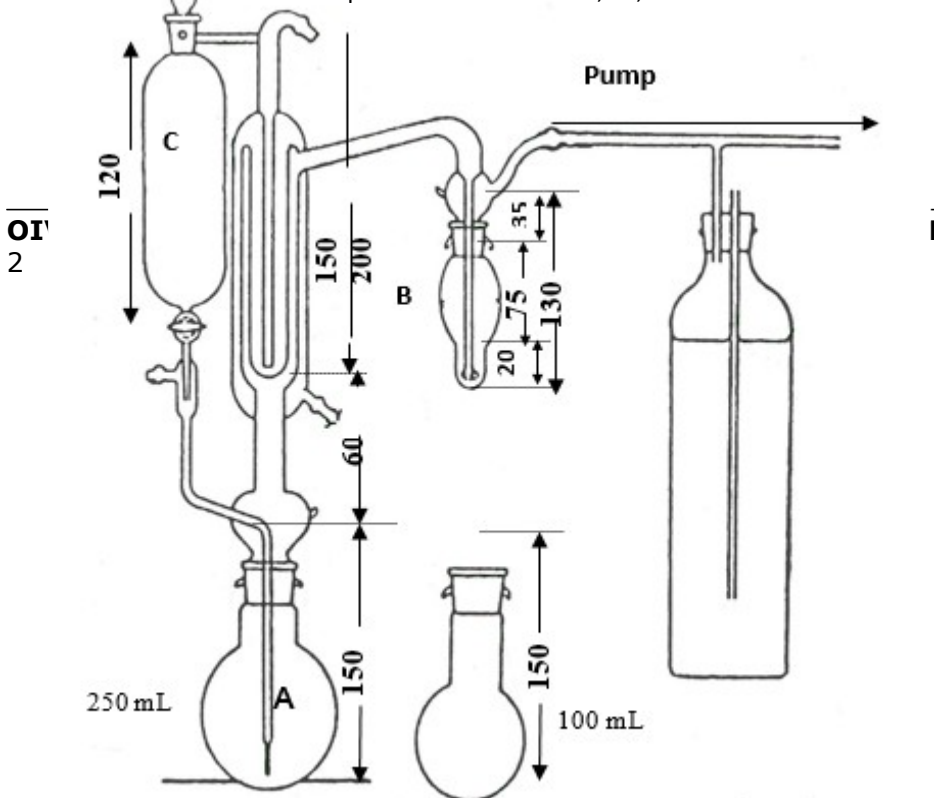

COMPENDIUM OF INTERNATIONAL METHODS OF ANALYSIS-OIV
Total sulphur dioxide

the neutralised hydrogen peroxide solution at the exit of the gas-supply tube should not change.

- Connect the water from the condenser.
- In bubbler B of the entrainment apparatus, introduce 2-3 mL hydrogen peroxide solution (4.5) and 2 drops of indicator reagent (4.2), and neutralise with the 0.01 M sodium hydroxide solution (4.4); a neutral pH = green colour.
Note: For large sample series, it is also possible to prepare an already neutralised H₂O₂ solution before introducing it into the flask. Adapt the concentrations and volumes accordingly, bearing in mind that the oxidative power of the solution must be maintained (reduced shelf life).
- Adapt this bubbler to the apparatus.
- Transfer 50 mL of sample to flask A if the presumed total SO₂ content in the sample is < 50 mg/L, and 20 mL of sample if the presumed total SO₂ content is ≥ 50 mg/L and attach it to the apparatus.
- Introduce 15 mL of phosphoric acid (4.1) into bulb C if the presumed total SO₂ content of the sample is < 50 mg/L and 5 mL phosphoric acid (4.1) if the presumed total SO₂ content of the sample is ≥ 50 mg/L.
- Open the tap to add the acid to the sample and activate the heat source, while simultaneously starting the gas flow and setting the timer to 15 minutes. Maintain at boiling point for the duration of the gas flow. The entrained total sulphur dioxide is oxidised into sulphuric acid.
- After 15 minutes, turn off the heat source, take bubbler B out, and rinse the gas supply tube (via the socket) with water.
- Titrate the acid formed by the 0.01 M sodium hydroxide solution (4.4) up to the green bend.

The number of millilitres used is expressed by n .

7 Calculations and expression of results

The total sulphur dioxide is expressed in milligrams per litre (mg/L), in whole numbers.

Calculations:

- Samples low in sulphur dioxide (50 mL sampling): 6.4 n
- Other samples (20 mL sampling): 16 n

8 Precision

8.1 Repeatability (r)

Content < 50 mg/L (50 mL sampling), r = 1 mg/L

Content ≥ 50 mg/L (20 mL sampling), r = 6 mg/L

8.2 Reproducibility (R)

Content < 50 mg/L (50 mL sampling), R = 9 mg/L

Content ≥ 50 mg/L (20 mL sampling), R = 15 mg/L

9 Bibliography

Paul, F., *Mitt. Klosterneuburg, Rebe u. Wein*, 1958, ser. A, 821.

Collaborative study

1. Scope of application

An international collaborative study, in accordance with Resolution OIV-OENO 6-2000, for the validation of updates to the methods for the determination of free sulphur dioxide and total sulphur dioxide (OIV-MA-AS323-04A), based on the decision of the OIV “Methods of Analysis” Sub-Commission, April 2018.

2. Standard references

- Update (draft) to the OIV-MA-AS323-04A methods,
- ISO 5725,
- Resolution OIV-OENO 6-2000.

3. Protocol

A total of 20 samples were prepared using homogeneous volumes of 10 wines from various wine regions in France and Portugal. Each sample was made up twice (the second as a blind duplicate), according to the double-blind principle.

The samples were prepared between 18 and 20 June 2018, then shipped without delay to the participating laboratories.

Sample no.	Blind duplicate no.	Nature of sample
A	1-14	Dry white wine
B	2-16	Dry white wine
C	3-19	Dry rosé wine
D	4-12	Dry rosé wine
E	5-20	Dry red wine
F	6-18	Dry red wine
G	7-11	Dry red wine
H	8-15	White liqueur wine
I	9-17	Red liqueur wine
J	10-13	Red liqueur wine

The analyses were carried out simultaneously by all participating laboratories between 16 and 20 July 2018. Samples were kept in refrigerated cabinets by

COMPENDIUM OF INTERNATIONAL METHODS OF ANALYSIS-OIV
Total sulphur dioxide

all laboratories between the date of reception and the date of analysis, according to the protocols sent.

The following laboratories provided their results:

Laboratory	City	Country
Estación de Viticultura e Enología de Galicia	Leiro (Ourense)	Spain
Laboratorio arbitral agroalimentario	Madrid	Spain
ASAE	Lisbon	Portugal
SCL Montpellier	Montpellier Cdex 5	France
HBLA und BA für Wein- und Obstbau	Klosterneuburg	Austria
Laboratorio de Salud Pública	Madrid	Spain
Laboratorio Agroambiental de Zaragoza	Zaragoza	Spain
Laboratoire SCL Bordeaux	Pessac Cedex - CS 98080	France
Unione Italiana Vini Servizi	Verona	Italy
Laboratorio Agroalimentario de Valencia	Burjassot (Valencia)	Spain
Agroscope	Nyon	Switzerland
Laboratoires Dubernet	Montredon des Corbières	France
Laboratoire Dioenos Rhône	Orange	France
Laboratoire Natoli	Saint Clément de Rivière	France

NB: The order of laboratories in the table does not correspond with the order in the following tables, in order to preserve the anonymity of results.

COMPENDIUM OF INTERNATIONAL METHODS OF ANALYSIS-OIV
Total sulphur dioxide

4. Free sulphur dioxide

4.1 Free SO₂ data

Free SO ₂ (mg/L)	A		B		C		D		E		F		G		H		I		J	
Sample	1	14	2	16	3	19	4	12	5	20	6	18	7	11	8	15	9	17	10	13
Labo 3			31	36	18	18	21	23	20	18	6	6	20	17	5	6				
Labo 5			37	35	21	24	24	25	20	20	8	7	20	20	3	4				
Labo 6	4	1	38	33	21	20	20	26	19	20	7	6	21	19	7	8	1	3	1	1
Labo 7	1	1	37	40	20	22	24	26	20	22	9	8	20	23	8	8	2	1	1	1
Labo 8			31	32	18	19	23	22	22	20	6	7	19	20	5	3	1	1		
Labo 9			35	34	23	19	25	24	21	24			17	17						
Labo 10	2	1	35	34	20	21	24	24	22	21	9	8	21	20	7	7	2	2	1	1
Labo 11	0	0	33	30	17	11	22	16	16	21	6	4	15	19	6	3	1	1	0	0
Labo 15			15	19	15	13	18	20	8	16	6	5	8	15	5	5				
Labo 17	0	0	37	38	24	26	28	28	26	23	8	8	24	22	7	7	1	2	0	0
Labo 18	0	4	33	31	21	11	23	27	15	19	6	4	9	20	3	4	1	1	0	0
Labo 20	0	0	32	32	20	19	21	21	29	21	8	8	20	18	12	4	1	1	0	0
Labo 21	2	1	33	38	19	15	25	22	19	21	6	6	19	20	8	7	2	1	0	0

Results left blank were rendered non-quantifiable (< limit of quantification).

	Result removed by the COCHRAN test at 5%
	Result removed by the GRUBBS test at 5%

COMPENDIUM OF INTERNATIONAL METHODS OF ANALYSIS-OIV
Total sulphur dioxide

4.2 Free SO₂ results

Free SO₂ (mg/L)	A	B	C	D	E	F	G	H	I	J
No. of laboratories selected	7	9	11	10	10	12	11	11	9	8
No. of repetitions	2	2	2	2	2	2	2	2	2	2
Min.	0	31.5	14	19	17	5	17	3.5	1	0
Max.	2.5	38.5	25	28	24.5	8.5	23	8	2	1
Mean	0.9	34.2	19.8	23.4	20.6	6.8	19.6	5.7	1.4	0.4
Standard deviation	0.98	2.67	2.91	2.46	2.04	1.31	1.77	1.72	0.42	0.52
Repeatability variance	0.79	1.67	2.59	1.20	2.60	0.58	2.23	0.82	0.39	0.00
Inter-laboratory standard deviation	0.98	2.67	2.91	2.46	2.04	1.31	1.77	1.72	0.42	0.52
Reproducibility variance	1.35	7.97	9.76	6.64	5.46	2.00	4.25	3.38	0.37	0.27
Repeatability standard deviation	0.89	1.29	1.61	1.10	1.61	0.76	1.49	0.90	0.62	0.00
r limit	2.48	3.61	4.51	3.07	4.51	2.14	4.18	2.53	1.75	0.00
Repeatability %CV (k=2)	191	8	16	9	16	23	15	32	90	0
Reproducibility standard deviation	1.16	2.82	3.12	2.58	2.34	1.41	2.06	1.84	0.61	0.52
R limit	3.25	7.90	8.75	7.22	6.54	3.96	5.78	5.15	1.70	1.45
Reproducibility %CV (k=2)	250	16	32	22	23	42	21	64	87	276
Horwitz PRSD _R (%)	16.18	9.40	10.21	9.95	10.15	12.00	10.22	12.30	15.23	18.55
Horwitz s _R	0.15	3.22	2.02	2.33	2.09	0.81	2.00	0.70	0.21	0.07
Horwitz R	0.42	9.10	5.71	6.59	5.91	2.29	5.67	1.99	0.60	0.20
Horwitz Ratio	7.64	0.87	1.53	1.10	1.11	1.73	1.02	2.58	2.84	7.37

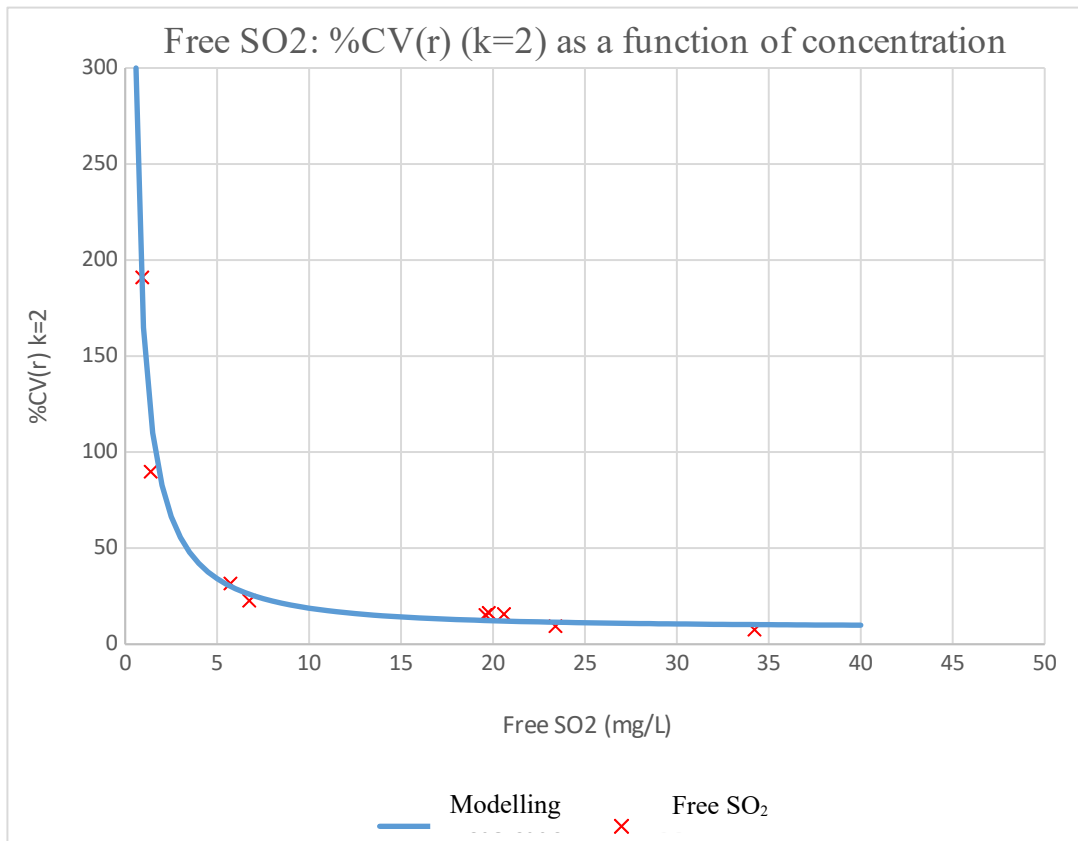

Figure 1: Modelling of the repeatability coefficient of variation, %CV(r) (k=2), as a function of the concentration, C:

$$\%CV(r) = \sqrt{\frac{164.55^2}{C^2} + 9^2}$$

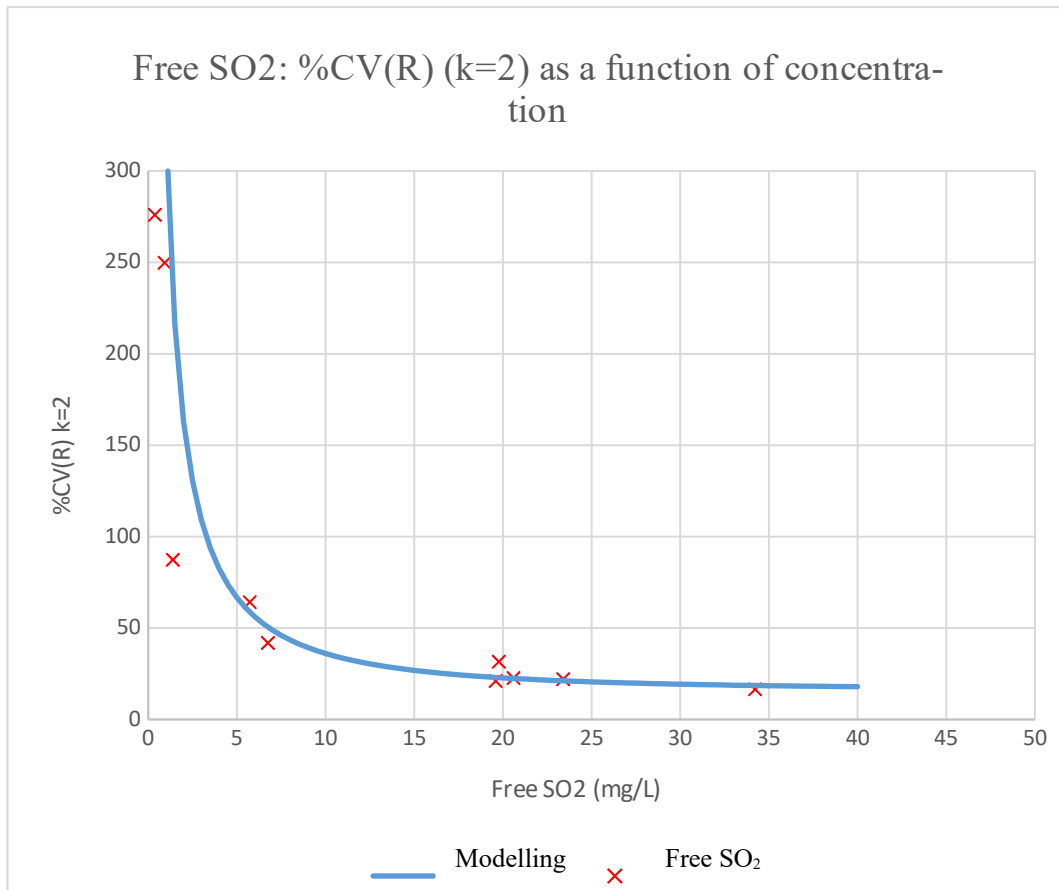

Figure 2: Modelling of the inter-laboratory reproducibility coefficient of variation, %CV(R) (k=2), as a function of concentration, C:

$$\%CV(R) = \sqrt{\frac{323.6^2}{C^2} + 16^2}$$

**COMPENDIUM OF INTERNATIONAL METHODS OF ANALYSIS-OIV
Total sulphur dioxide**

5. Total sulphur dioxide

5.1. Total SO₂ data

Total SO ₂ (mg/L)	A		B		C		D		E		F		G		H		I		J	
Sample	1	14	2	16	3	19	4	12	5	20	6	18	7	11	8	15	9	17	10	13
Labo 3			128	127	72	73	128	131	61	59	28	28	57	56	102	102	47	45		
Labo 5			122	121	68	71	112	114	42	53	22	22	51	42	102	101	35	34		
Labo 6		1	128	131	72	72	126	131	53	54	22	20	42	49	98	99	31	34	3	1
Labo 7	3	3	131	131	70	74	130	131	54	59	26	23	46	48	106	101	37	40	1	1
Labo 8	2	1	125	127	72	72	129	128	58	57	22	23	46	45	97	99	42	39	1	1
Labo 9			120	128	77	75	132	108	71	59	21	25	44	47	110	99	38	48		
Labo 10	2	2	130	130	74	76	130	130	61	61	28	32	55	56	103	104	43	44	3	4
Labo 11	4	3	119	125	71	74	118	118	39	40	18	21	45	41	89	94	26	38	2	2
Labo 14	3	3	129	128	72	72	127	129	58	58	32	29	50	49	102	101	42	41	3	4
Labo 15			134	136	76	78	134	136	60	58	39	27	52	61	110	106	51	50		
Labo 17	3	3	134	132	82	76	136	133	59	50	24	23	46	44	107	105	35	38	0	0
Labo 18	5	3	130	129	78	73	133	133	62	59	29	32	58	52	105	105	50	48	2	2
Labo 20	1	1	128	131	72	74	130	130	58	56	26	28	48	45	98	93	41	43	0	0
Labo 21		0	124	125	69	72	124	126	45	51	19	20	42	42	97	97	35	34	0	1

Results left blank were rendered non-quantifiable (< limit of quantification).

	Result removed by the COCHRAN test at 5%
	Result removed by the GRUBBS test at 5%

5.2 Total SO₂ results

Total SO ₂ (mg/L)	A	B	C	D	E	F	G	H	I	J
OIV-MA-AS323-04A2										
7							R2021			

COMPENDIUM OF INTERNATIONAL METHODS OF ANALYSIS-OIV
Total sulphur dioxide

No. of laboratories selected	7	12	13	13	8	13	10	13	12	9
No. of repetitions	2	2	2	2	2	2	2	2	2	2
Min.	1	121.5	69.5	113	53.5	19.5	42	91.5	32.5	0
Max.	3.5	135	77	135	61	30.5	56.5	108	50.5	3.5
Mean	2.4	128.8	73.0	128.0	58.3	24.7	47.6	100.9	40.8	1.5
Standard deviation	0.93	3.63	2.20	6.24	2.42	4.04	4.89	4.61	5.80	1.35
Repeatability variance	0.14	1.46	3.27	2.35	1.44	3.04	2.30	3.96	2.21	0.17
Inter-laboratory standard deviation	0.93	3.63	2.20	6.24	2.42	4.04	4.89	4.61	5.80	1.35
Reproducibility variance	0.94	13.93	6.49	40.11	6.57	17.84	25.03	23.28	34.72	1.90
Repeatability standard deviation	0.38	1.21	1.81	1.53	1.20	1.74	1.52	1.99	1.49	0.41
r limit	1.1	3.4	5.1	4.3	3.4	4.9	4.2	5.6	4.2	1.1
Repeatability %CV (k=2)	31	2	5	2	4	14	6	4	7	54
Reproducibility standard deviation	0.97	3.73	2.55	6.33	2.56	4.22	5.00	4.82	5.89	1.38
R limit	2.7	10.5	7.1	17.7	7.2	11.8	14.0	13.5	16.5	3.9
Reproducibility %CV (k=2)	80	6	7	10	9	34	21	10	29	184
Horwitz PRSD _R (%)	14.00	7.70	8.39	7.71	8.68	9.87	8.95	7.99	9.16	15.05
Horwitz s _R	0.34	9.92	6.13	9.86	5.06	2.44	4.26	8.06	3.73	0.23
Horwitz R	0.96	28.05	17.33	27.90	14.31	6.91	12.04	22.80	10.56	0.64
Horwitz Ratio	2.82	0.37	0.41	0.64	0.50	1.71	1.16	0.59	1.56	6.04

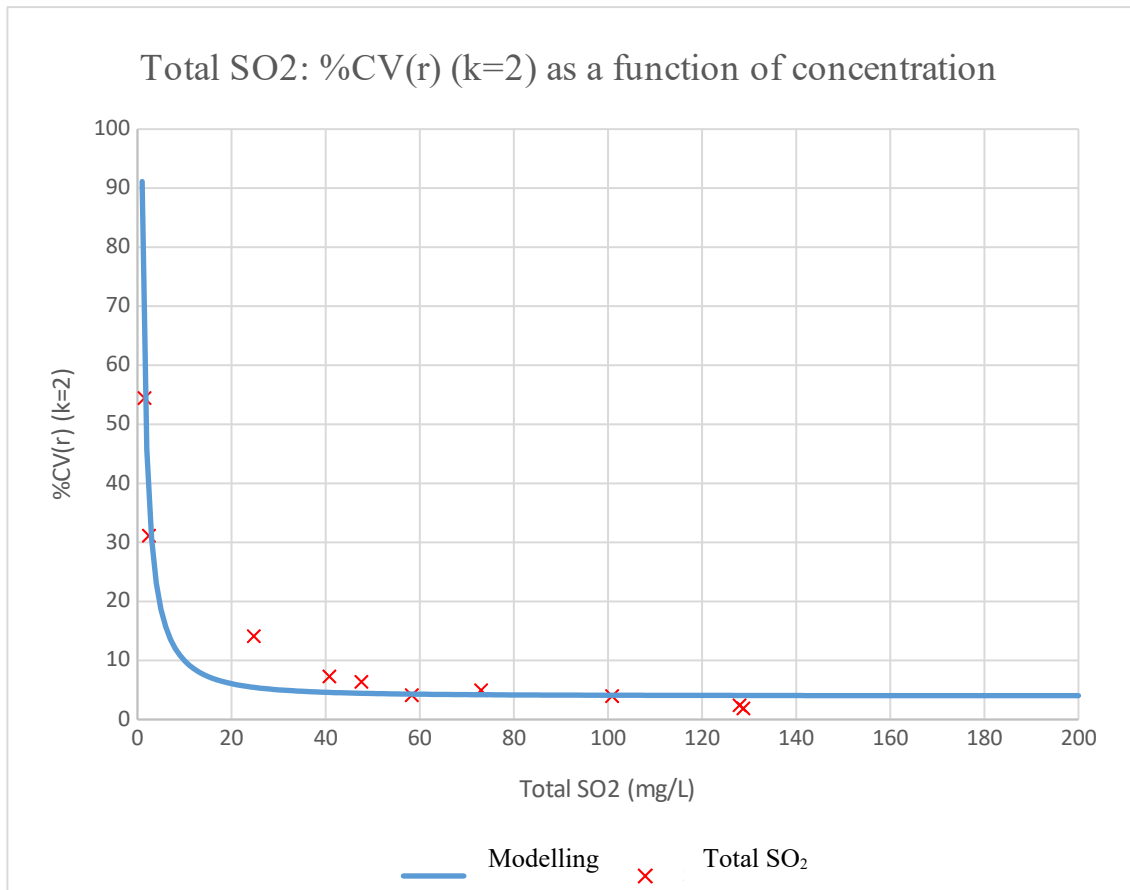

Figure 3: Modelling of the repeatability coefficient of variation, %CV(r) (k=2), as a function of concentration, C:

$$\%CV(r) = \sqrt{\frac{91^2}{C^2} + 4^2}$$

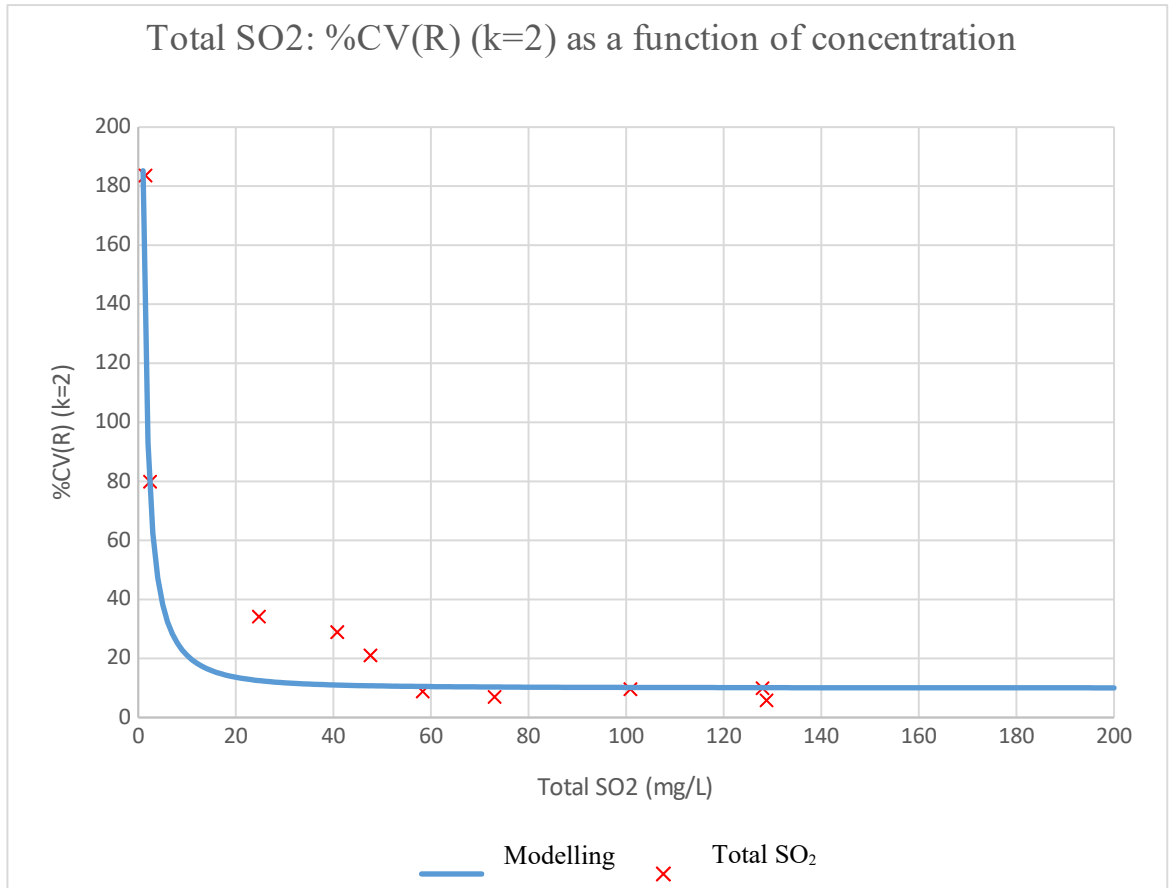

Figure 4: Modelling of the inter-laboratory reproducibility coefficient of variation, %CV_R (k=2), as a function of concentration, C:

$$\%CV(R) = \sqrt{\frac{184.9^2}{C^2} + 10^2}$$

Sulfur dioxide

(A17 revised by OIV/OENO 377/2009)

1. Definitions

Free sulfur dioxide is defined as the sulfur dioxide present in the must or wine in the following forms: H_2SO_3 , HSO_3^- , whose equilibrium as a function of pH and temperature is:



H_2SO_3 represents molecular sulfur dioxide.

Total sulfur dioxide is defined as the total of all the various forms of sulfur dioxide present in the wine, either in the free state or combined with their constituents.

2. Free and Total Sulfur Dioxide

2.1 Principle

Free sulfur dioxide is determined by direct titration with iodine. The combined sulfur dioxide is subsequently determined by iodometric titration after alkaline hydrolysis. When added to the free sulfur dioxide, it gives the total sulfur dioxide.

2.2 Rapid Method

2.2.1 Reagents

2.2.1.1 EDTA: ethylenediaminetetraacetic acid, *di*-sodium salt

2.2.1.2 4 M Sodium hydroxide solution (160 g/L).

2.2.1.3 Dilute sulfuric acid: 10% sulfuric acid ($r_{20} = 1.84$ g/mL) diluted 10% (v/v).

2.2.1.4 Starch solution, 5 g/L.

Mix 5 g starch with approx. 500 mL water. Bring to a boil stirring continuously and keep boiling for 10 minutes. Add 200 g of sodium chloride. Cool and make to 1 liter.

2.2.1.5 0.025 M Iodine solution

2.2.2 Free sulfur dioxide

Place in a 500 mL conical flask place:

- 50 mL of wine
- 5 mL starch solution
- 30 mg EDTA

**COMPENDIUM OF INTERNATIONAL METHODS OF ANALYSIS -
OIV
Sulfur dioxide**

- 3 mL H₂SO₄

Immediately titrate with 0.025 M iodine, until the blue color persists clearly for 10 to 15 seconds. Let n mL be the volume of iodine used.

2.2.3 Combined sulfur dioxide

Add 8 mL of 4 M sodium hydroxide solution, shake the mixture once and allow to stand for 5 minutes. Add, with vigorous stirring and in one operation, the contents of a small beaker in which 10 mL of sulfuric acid have been placed. Titrate immediately with the 0.025 M iodine solution; let n' be the volume used.

Add 20 mL of sodium hydroxide solution, shake once and allow to stand for 5 minutes. Dilute with 200 mL of ice-cold water. Add, while stirring vigorously and in one operation, the contents of a test tube in which 30 mL sulfuric acid has previously been placed. Titrate the free sulfur dioxide immediately with the 0.025 M iodine, and let n'' be the volume of iodine used.

2.2.4 Expression of the results

2.2.4.1 Calculation

Free sulfur dioxide in milligrams per liter is given by:

$$32 \cdot n$$

Total sulfur dioxide in milligrams per liter is given by:

$$32 (n + n' + n'')$$

Remarks:

1. For red wines with low SO₂ concentrations, the 0.025 M iodine may be diluted (for example: 0.01 M). In this case, replace the coefficient 32 by 12.8 in the above formula.
2. For red wines, it is useful to illuminate the wine from below with a beam of yellow light from an ordinary electric light bulb shining through a solution of potassium chromate or from a sodium vapor lamp. The determination should be carried out in a dark room and the transparency of the wine observed: it becomes opaque when the starch endpoint is reached.

**COMPENDIUM OF INTERNATIONAL METHODS OF ANALYSIS -
OIV
Sulfur dioxide**

3. If the quantity of sulfur dioxide found is close to or exceeds the legal limit, the total sulfur dioxide should be determined with the reference method.
4. If the determination of free sulfur dioxide is specifically required, carry out a determination on a sample kept under anaerobic conditions for two days at 20 °C before analysis. Carry out the determination at 20 °C.
5. Because certain substances are oxidized by iodine in an acid medium, the quantity of iodine used in this way must be assessed for more accurate determinations. To achieve this, combine the free sulfur dioxide in an excess of ethanal or propanal before beginning the titration with iodine. Place 50 mL of wine into a 300 mL conical flask, add 5 mL of 7 g/L ethanol solution or 5 mL of a 10 g/L propanal solution. Stopper the flask and allow to stand for at least 30 minutes. Add 3 mL of sulfuric acid and sufficient iodine, 0.025 M, to cause the starch to change color. Let n''' mL be the volume of iodine used. This must be subtracted from n (free sulfur dioxide), and from $n + n' + n''$ (total sulfur dioxide). n''' is generally small, from 0.2 to 0.3 mL of 0.025 M iodine. If ascorbic acid has been added to the wine, n''' will be much higher and it is possible, at least approximately, to measure the amount of this substance from the value of n''' given that 1 mL of 0.025 M iodine will oxidize 4.4 mg ascorbic acid. By determining n''' , it is possible to detect quite easily the presence of residual ascorbic acid in amounts greater than 20 mg/L, in wines to which it has been added.

BIBLIOGRAPHY

Rapid method:

RIPPER M., *J. Prakt. Chem.*, 1892, **46**, 428.

JAULMES, P., DIEUZEIDE J.-C., *Ann. Fals. Fraudes*, 1954, **46**, 9;
Bull. O.I.V., 1953, **26**, n° 274, 52.

KIELHOFER E., AUMANN H., *Mitt. Klosterneuburg, Rebe u. Wein*, 1957, **7**, 289.

**COMPENDIUM OF INTERNATIONAL METHODS OF ANALYSIS -
OIV
Sulfur dioxide**

JAULMES P., HAMELLE M^{me} G., *Ann. Fals. Exp. Chim.*, 1961,
54, 338

Sulfur dioxide

(A17 revised by OIV/OENO 377/2009)

1. Definitions

Free sulfur dioxide is defined as the sulfur dioxide present in the must or wine in the following forms: H_2SO_3 , HSO_3^- , whose equilibrium as a function of pH and temperature is:

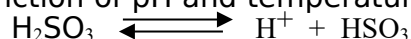

H_2SO_3 represents molecular sulfur dioxide.

Total sulfur dioxide is defined as the total of all the various forms of sulfur dioxide present in the wine, either in the free state or combined with their constituents.

2 Molecular Sulfur Dioxide

2.1 Principle of the Method

The percentage of molecular sulfur dioxide, H_2SO_3 , in free sulfur dioxide, is calculated as a function of pH, alcoholic strength and temperature.

For a given temperature and the alcoholic strength:

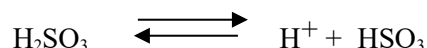

$$[\text{H}_2\text{SO}_3] = \frac{L}{10^{(\text{pH} - \text{p}k_M)} + 1}$$

(1)
where

$$L = [\text{H}_2\text{SO}_3] + [\text{HSO}_3^-]$$

$$\text{p}k_M = \text{p}k_T - \frac{A \sqrt{I}}{I + B \sqrt{I}}$$

I = ionic strength

A & B = Coefficients which vary according to temperature and alcoholic strength.

k_T = Thermodynamic dissociation constant; the value of $\text{p}k_T$ is given in Table 1 for various alcoholic strengths and temperatures.

k_M = Mixed dissociation constant

**COMPENDIUM OF INTERNATIONAL METHODS OF ANALYSIS -
OIV
Sulfur dioxide**

Taking a mean value 0.038 for the ionic strength I , Table 2 gives the values of pK_M for various temperatures and alcoholic strengths.

The molecular sulfur dioxide content calculated by the relationship given in (1) is presented in Table 3 for various values of pH, temperature and alcoholic strength.

2.2 Calculations

Knowing the pH of wine and its alcoholic strength, the percentage of molecular sulfur dioxide is given in Table 3 for a temperature t °C. Let this be X %.

The amount of molecular sulfur dioxide in mg/L is given by: $X \cdot C$

C = the free sulfur dioxide in mg/L

Table I

Values of the thermodynamic constant pK_T

Alcohol % by volume	Temperature °C				
	20	25	30	35	40
0	1.798	2.000	2.219	2.334	2.493
5	1.897	2.098	2.299	2.397	2.527
10	1.997	2.198	2.394	2.488	2.606
15	2.099	2.301	2.503	2.607	2.728
20	2.203	2.406	2.628	2.754	2.895

Table II

Values of the Mixed Dissociation Constant pK_M ($I= 0.038$)

Alcohol % by volume	Temperature °C				
	20	25	30	35	40
0	1.723	1.925	2.143	2.257	2.416
5	1.819	2.020	2.220	2.317	2.446
10	1.916	2.116	2.311	2.405	2.522

**COMPENDIUM OF INTERNATIONAL METHODS OF ANALYSIS -
OIV
Sulfur dioxide**

15	2.014	2.216	2.417	2.520	2.640
20	2.114	2.317	2.538	2.663	2.803

**COMPENDIUM OF INTERNATIONAL METHODS OF ANALYSIS -
OIV
Sulfur dioxide**

Table III
Molecular Sulfur Dioxide as a Percentage of Free Sulfur Dioxide
(I=0.038)

pH	T = 20 °C Alcohol % by volume				
		0	10	15	20
2.8	7.73	9.46	11.55	14.07	17.09
2.9	6.24	7.66	9.40	11.51	14.07
3.0	5.02	6.18	7.61	9.36	11.51
3.1	4.03	4.98	6.14	7.58	9.36
3.2	3.22	3.99	4.94	6.12	7.58
3.3	2.58	3.20	3.98	4.92	6.12
3.4	2.06	2.56	3.18	3.95	4.92
3.5	1.64	2.04	2.54	3.16	3.95
3.6	1.31	1.63	2.03	2.53	3.16
3.7	1.04	1.30	1.62	2.02	2.53
3.8	0.83	1.03	1.29	1.61	2.02
T = 25 °C					
2.8	11.47	14.23	17.15	20.67	24.75
2.9	9.58	11.65	14.12	17.15	22.71
3.0	7.76	9.48	11.55	14.12	17.18
3.1	6.27	7.68	9.40	11.55	14.15
3.2	5.04	6.20	7.61	9.40	11.58
3.3	4.05	4.99	6.14	7.61	9.42
3.4	3.24	4.00	4.94	6.14	7.63
3.5	2.60	3.20	3.97	4.94	6.16
3.6	2.07	2.56	3.18	3.97	4.55
3.7	1.65	2.05	2.54	3.18	3.98
3.8	1.32	1.63	2.03	2.54	3.18
T = 30 °C					
2.8	18.05	20.83	24.49	29.28	35.36
2.9	14.89	17.28	20.48	24.75	30.29
3.0	12.20	14.23	16.98	20.71	25.66
3.1	9.94	11.65	13.98	17.18	21.52
3.2	8.06	9.48	11.44	14.15	17.88
3.3	6.51	7.68	9.30	11.58	14.75
3.4	5.24	6.20	7.53	9.42	12.08
3.5	4.21	4.99	6.08	7.63	9.84
3.6	3.37	4.00	4.89	6.16	7.98
3.7	2.69	3.21	3.92	4.95	6.44
3.8	2.16	2.56	3.14	3.98	5.19

**COMPENDIUM OF INTERNATIONAL METHODS OF ANALYSIS -
OIV
Sulfur dioxide**

Table III (continued)

Molecular Sulfur Dioxide as a Percentage of Free Sulfur Dioxide (I=0.038)

pH	T=35 °C				
	Alcohol % by volume				
	0	5	10	15	20
2.8	22.27	24.75	28.71	34.42	42.18
2.9	18.53	20.71	24.24	29.42	36.69
3.0	15.31	17.18	20.26	24.88	31.52
3.1	12.55	14.15	16.79	20.83	26.77
3.2	10.24	11.58	13.82	17.28	22.51
3.3	8.31	9.42	11.30	14.23	18.74
3.4	6.71	7.63	9.19	11.65	15.49
3.5	5.44	6.16	7.44	9.48	12.71
3.6	4.34	4.95	6.00	7.68	10.36
3.7	3.48	3.98	4.88	6.20	8.41
3.8	2.78	3.18	3.87	4.99	6.80
T = 40 °C					
2.8	29.23	30.68	34.52	40.89	50.14
2.9	24.70	26.01	29.52	35.47	44.74
3.0	20.67	21.83	24.96	30.39	38.85
3.1	17.15	18.16	20.90	25.75	33.54
3.2	14.12	14.98	17.35	21.60	28.62
3.3	11.55	12.28	14.29	17.96	24.15
3.4	9.40	10.00	11.70	14.81	20.19
3.5	7.61	8.11	9.52	12.13	16.73
3.6	6.14	6.56	7.71	9.88	13.77
3.7	4.94	5.28	6.22	8.01	11.25
3.8	3.97	4.24	5.01	6.47	9.15

BIBLIOGRAPHY

Molecular sulfur dioxide:

BEECH F.W. & TOMAS M^{me} S., *Bull. O.I.V.*, 1985, **58**, 564-581.

USSEGLIO-TOMASSET L. & BOSIA P.D., *F.V., O.I.V.*, 1984, n° 784.

Method OIV-MA-AS323-06

Type IV method

**Determination of mercury in wine by vapour
generation and atomic spectrofluorimeter**

OENO 15/2002; OIV/OENO 377/2009

1. FIELD OF APPLICATION

This method applies to the analysis of mercury in wines with a concentration range between 0 to 10 µg/l.

2. DESCRIPTION OF TECHNIQUE

2.1. Principle of the method

- 2.1.1 Mineralisation of wine takes place in an acid environment: heating under reflux; mineralisation is achieved with a potassium permanganate.
- 2.1.2. Reduction of non-consumed permanganate by hydroxylamine hydrochlorate
- 2.1.3. Reduction in mercury II (metal mercury by stannous chloride (II).
- 2.1.4. Mercury pick up by an argon current at ambient temperature
- 2.1.5. Dosage of mercury in monoatomic vapour state by atomic fluorescence spectrometry with wavelength of 254 nm. Mercury atoms are excited by a mercury vapour lamp; the atoms thus excited emit a radiation called fluorescent which allows the quantification of mercury present using a photonics detector to obtain good linearity while eliminating memory effects.

2.2 Principle of analysis (figure 1)

The peristaltic pump absorbs the stannous chloride solution, the blank solution (demineralised water containing 1% nitric acid) and the sample of mineralised wine.

The mercury metal is taken up in a gas-liquid separator by a current of argon. After going through a drying tube, the mercury is detected by fluorescence. Then, the gaseous current goes through a permanganate potassium solution in order to capture the mercury.

**COMPENDIUM OF INTERNATIONAL METHODS OF ANALYSIS -
OIV
Mercury - Atomic Spectrofluorimetry**

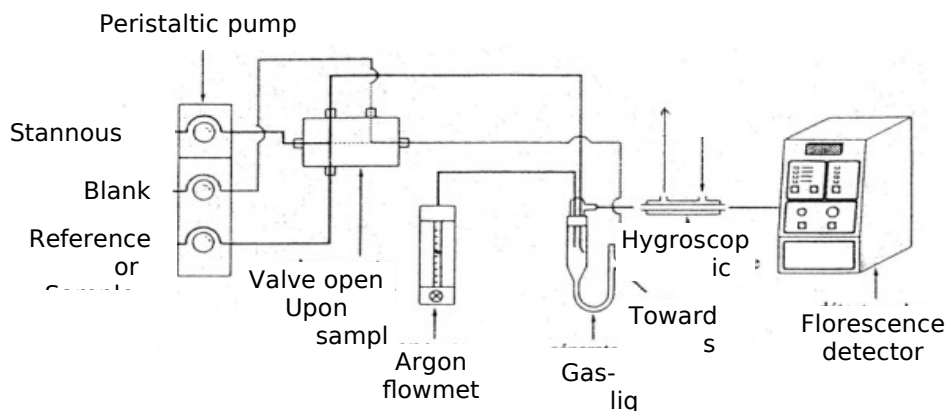

Figure n°1. Analytic Chain for dosage of mercury

3. REAGENTS AND PREPARATION OF REACTIVE SOLUTIONS

3.1 Ultra-pure demineralised water

3.2 Ultra-pure 65% nitric acid

3.3 White: demineralised water (3.1) containing 1% of nitric acid (3.2)

3.4 Nitric acid solution 5.6 M (3.1):

Put 400 ml of nitric acid (3.2) into a 1000 ml flask; fill with demineralised water (3.1).

3.5 Sulphuric acid (d= 1.84)

3.6 Sulphuric acid solution 9M:

Put 200 ml of demineralised water (3.1), 50 g of potassium permanganate (3.7) into a 1000 ml flask; fill with demineralised water (3.1).

3.7 Potassium permanganate KMnO₄

3.8 5% Potassium permanganate solution:

Dissolve 50 g of potassium permanganate (3.7) with demineralised water (3.1), in a 1000 ml flask. Fill with demineralised water (3.1).

3.9 Hydroxylamine hydrogen chloride NH₂OH, HCl

3.10 Reducing solution:

**COMPENDIUM OF INTERNATIONAL METHODS OF ANALYSIS -
OIV**

Mercury - Atomic Spectrofluorimetry

Weigh 12g of hydroxylamine hydrogen chloride (3.9) and dissolve in 100 ml of demineralised water (3.1).

3.11 Stannous chloride (SnCl₂, 2 H₂O)

3.12 Concentrated hydrochloric acid

3.13 Stannous chloride solution:

Weigh 40 g of stannous chloride (3.11) and dissolve in 50 ml of hydrochloric acid (3.12). Fill with 200 ml of demineralised water (3.1).

3.14 Mercury standard solution at 1g/l

prepared by dissolving 1708 g of Hg (NO₃). H₂O in an aqueous nitric acid solution at 12% prepared from metal mercury.

3.15 Reference mercury solution at 10 mg/l :

Place 1 ml of mercury standard solution (3.14) in a 100 ml volumetric flask, add 5 ml of nitric acid, fill with demineralised water (3.1)

3.16 Mercury solution at 50 mg/l:

Place 1 ml of 10 mg/l (3.15) solution in a 200 ml flask. Add 2 ml of nitric acid (3.2). Fill with demineralised water (3.1).

4. APPARATUS

4.1 Glass ware

4.1.1 Volumetric flasks 100, 200, and 1000 ml (class A)

4.1.2 Volumetric pipette 0.5, 1.0, 2.0, 5, 10 and 20 ml (class A)

4.1.3 Precautionary action: Before using, the glass ware must be washed with 10% nitric acid, leave in contact 24 hours, then rinse with demineralised water.

4.2 Mineralisation apparatus (figure 2)

4.3 Temperature controlled heating mantle

4.4 Squeeze pump

4.5 Cold vapour generator

4.5.1 Liquid gas separator

4.6 Desiccant (Hygroscopic membrane) covered by an air current (supplied from a compressor) and placed before the detector

4.7 Spectrofluorimeter

**COMPENDIUM OF INTERNATIONAL METHODS OF ANALYSIS -
OIV**

Mercury - Atomic Spectrofluorimetry

4.7.1 Mercury vapour lamp regulated to 254 nm wave length

4.7.2 Atomic fluorescence specific detector

4.8 Computer

4.8.1 Software which regulates the parameters of the vapour generator and the atomic fluorescence detector and enables calibration and usage of the results.

4.8.2 Printer which stores results

4.9 Neutral gas bottle (argon)

5. PREPARATION OF CALLIBRATION SOLUTIONS AND SAMPLES

5.1 SET OF CALLIBRATION SOLUTIONS: 0; 0.25; 0.5; and 1.0 ug/L

Introduce : 0; 0.5; and 1.0 and 2.0 ml of the mercury solution to 50 ug/l (3.16.) in 4 100 ml flasks; add 1 % nitric acid (3.2.); fill with demineralised water (3.1.).

5.2. Preparation of samples (figure 2)

Wine is mineralised in a glass pyrex apparatus made up of three parts joined by spherical honing: a 250 ml balloon, a vapour recuperation chamber, a refrigerant.

Using a pipette put 20 ml of wine in a 250 ml reaction flask; assemble the mineralisation apparatus.

Add 5 ml of sulphuric acid (3.6.) and 10 ml of nitric acid (3.4.) slowly; leave overnight.

Heat slowly under reflux until the nitrous vapours disappear ; leave to cool. Recover the condensed vapours in the reaction flask. Rinse the recipient with demineralised water. Pour the contents of the reaction flask into a 100 ml volumetric flask. Add potassium permanganate solution (3.8.) until the colour remains. Solubilize the precipitate (MnO₂) with a reducing solution (3.10.). Fill with demineralised water (3.1.).

Carry out a blank test on demineralised water.

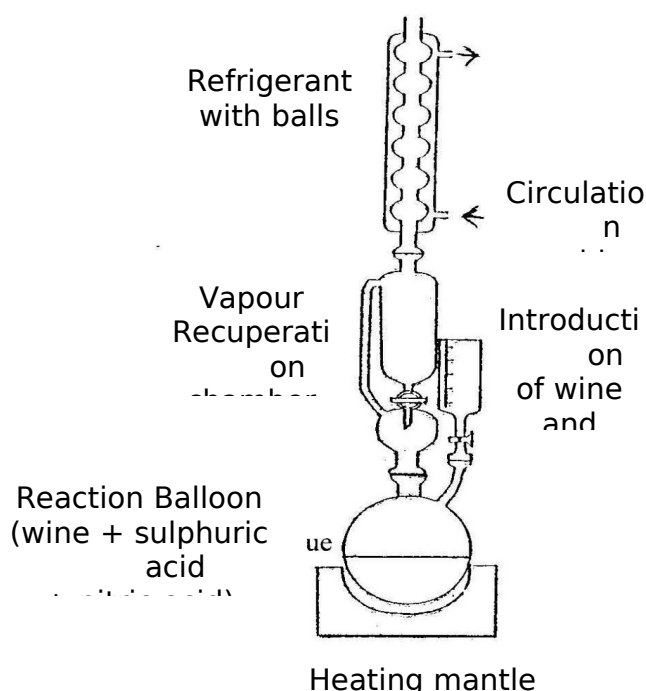

Figure n°2. Mineralisation apparatus

6. OPERATING PROCEDURE

6.1 Analytical measurement

Turn on the fluorimeter; the apparatus is stable after 15 minutes. The squeeze pump absorbs the white (3.3), the stannous lead II (3.13) and the sample calibrations (5.1) or (5.2.) Verify that bubbling occurs in the liquid gas separator. Present the calibration samples successively (5.1); set off the vapour generator program. The computer software establishes a calibration curve (percentage of fluorescence according to concentration of mercury $\mu\text{g/l}$). Then present the samples (5.2).

6.2 Automatic checks

A blank analysis and a calibration are analysed every five tests to correct any possible spectrofluorimeter derivatives.

**COMPENDIUM OF INTERNATIONAL METHODS OF ANALYSIS -
OIV
Mercury - Atomic Spectrofluorimetry**

7. EXPRESSION OF RESULTS

Results are provided by the computer software and expressed in ug/l. Deduct the mercury concentration in wine in ug/l keeping into account 1/5 dilution.

8. CHECKING RESULTS

Quality control is carried out by placing reference material in which the mercury content is known, following the set of calibrations and every 5 samples. Following the analytical series, the reference material is red wine, dry white wine or sweet white wine.

The check card is set for each reference material used. The check limits are set at: $\pm 2S_R$ intra ($2S_R$ intra : reproducibility spread-type)

The uncertainly calculation, carried out on check cards, resulted in a red wine reference of: 3.4 ± 0.8 ug/l and for reference dry white wine : 2.8 ± 0.9 ug/l.

9. BIBLIOGRAPHY

CAYROL M., BRUN S., 1975. Dosage du mercure dans les vins. Feuille Vert de l'O.I.V. n°371.

REVUELTA D., GOMEZ R., BARDON A., 1976. Dosage du mercure dans le vin par la méthode des vapeurs froides et spectrométrie d'absorption atomique. Feuille Vert de l'O.I.V. n°494.

CACHO J., CASTELLS J.E., 1989. Determination of mercury in wine by flameless atomic absorption spectrophotometry. Atomic Spectroscopy, vol. 10, n°3.

STOCKWELL P.B., CORNS W.T., 1993. The role of atomic fluorescence spectrometry in the automatic environmental monitoring of trace element analysis. Journal of Automatic Chemistry, vol. 15, n°3, p 79-84.

SANJUAN J., COSSA D., 1993. Dosage automatique du mercure total dans les organismes marins par fluorescence atomique. IFREMER, Rapport d'activité.

AFNOR, 1997. Dosage du mercure total dans les eaux par spectrométrie de fluorescence atomique. XPT 90-113-2.

GAYE J., MEDINA B., 1998. Dosage du mercure dans le vin par analyse en flux continu et spectrofluorimétrie. Feuille Vert de l'O.I.V. n°1070.

Multielemental analysis in wine using
inductively coupled plasma- Mass
spectrometry (ICP-MS)
(OIV-OENO 666-2023)

1. SCOPE OF APPLICATION

This method can be applied to the analysis of the elements present in wines within the range of concentrations indicated and featured in the following list:

- Aluminium between 0.25 and 5.0 mg/L
- Arsenic between 0.010 and 10 mg/L
- Boron between 10 and 40 mg/L
- Bromine between 0.20 and 2.5 mg/L
- Cadmium between 0.001 and 0.040 mg/L
- Cobalt between 0.002 and 0.050 mg/L
- Copper between 0.10 and 2.0 mg/L
- Strontium between 0.30 and 1.0 mg/L
- Iron between 0.80 and 5.0 mg/L
- Lithium between 0.010 and 0.050 mg/L
- Magnesium between 50 and 300 mg/L
- Manganese between 0.50 and 1.5 mg/L
- Nickel between 0.010 and 0.20 mg/L
- Lead between 0.010 and 0.20 mg/L
- Rubidium between 0.50 and 1.2 mg/L
- Sodium between 5 and 30 mg/L
- Vanadium between 0.003 and 0.20 mg/L
- Zinc between 0.30 and 1.0 mg/L

¹ Type II for listed elements except arsenic. Type IV for arsenic.

COMPENDIUM OF INTERNATIONAL ANALYSIS OF METHODS - OIV
Multielemental analysis in wine using inductively coupled
plasma- Mass spectrometry (ICP-MS)

The ICP-MS technique can also be used to analyze other elements in wine.

Optionally, in some samples, such as, for example, of wines with more than 100 g/L of sugars, prior mineralization may be beneficial. In this case, it is recommended to perform a digestion with nitric acid in a closed microwave system.

The method can also be applied to musts, after mineralization.

2. BASIS

Multielemental quantitative determination using Inductively Coupled Plasma Mass Spectrometry (ICP-MS).

Injection and nebulization of the sample in high-frequency plasma. The plasma causes the desolvation, atomization and ionization of the elements in the sample. The ions are extracted using a vacuum system fitted with ionic lenses. The ions are separated according to the mass-to-charge ratio in a mass spectrometer, for example, a quadrupole. Detection and quantification of ions is performed using an electron multiplier system.

3. REAGENTS AND SOLUTIONS

3.1. Grade 1 water, in accordance with ISO 3696.

3.2. Certified solution(s) (for example, 100 mg/L) containing the metals to be analyzed. Multielemental or monoelemental solutions can be used.

3.3. Internal standard solutions (normally 1 g/L). Some examples of internal standards that can be used in this method are indium, scandium, tellurium, rhodium, yttrium, iridium and germanium (tellurium, yttrium and germanium are specifically recommended for As determination).

3.4. Nitric acid (HNO₃) ≥ 60 % V/V (metal impurities ≤ 0.1 µg/L). CAS 7697-37-2

3.5. Argon, minimum purity of 99.999%. CAS 7440-37-1

3.6. Nitrogen (maximum impurity content: H₂O ≤ 3 mg/L, O₂ ≤ 2 mg/L and CnHm ≤ 0.5 mg/L). CAS 7727-37-9.

COMPENDIUM OF INTERNATIONAL ANALYSIS OF METHODS - OIV
Multielemental analysis in wine using inductively coupled
plasma- Mass spectrometry (ICP-MS)

3.7. Isopropyl alcohol, minimum purity of 99.8%. CAS 67-63-0

NOTE: the laboratory will demonstrate through the study of the reagent blanks the absence of contamination of the elements that being analyzed, for the volumes of additions specified in the method.

Solution concentration and internal standards are given by way of reference.

Preparation of standard solutions:

The concentration of nitric acid in the standards and in the final dilution of the wine samples must be the same. The concentration of nitric acid that can be used will depend on the ICP-MS device tolerance (usually between 1 to 5% (V/V)). The following is an example.

3.8. Stock solution (5 mg/L).

Place 5 mL of water (3.1) and 500 μ L of solution (3.2) in a 10 mL (4.4) tube and add 100 μ L of HNO₃ (3.4). Level off to 10 mL with water (3.1) and homogenize.

3.9. Internal standard solution (1 mg/L).

Using micropipettes (4.3), place 25 mL of water, 50 μ L of indium or rhodium solution (3.3) and 500 μ L of HNO₃ (3.4) in a 50 mL tube (4.5). Level off to 50 mL with water (3.1) and homogenize.

3.10. Internal standard solution (for on-line addition of the internal standard).

The internal standard solution can be inserted via a separate channel of the tubing pump, mixed with the sample and calibration solution using a Y-piece.

Prepare this solution diluting solution 3.9, according to the internal diameter (ID) of the inlet tubes so that, in the final mixture, the concentration of the internal standard is, for example, 10 μ g/L.

3.11. Standard solutions of the calibration curve.

Will be prepared by diluting the stock solution (3.8). Adapt the range of the series of standards according to the dilution on the sample or the equipment used.

Use 1000 μ L and 100 μ L pipettes (4.3).

Add internal standard so that its final concentration in the dilution is equal in the standards and in the samples (10 μ g/L in this example). When the internal standard is added on-line, as explained in section 3. 10, the internal standard is not added to the calibration solution.

COMPENDIUM OF INTERNATIONAL ANALYSIS OF METHODS - OIV
Multielemental analysis in wine using inductively coupled
plasma- Mass spectrometry (ICP-MS)

These standard solutions can also be prepared gravimetrically.

4. MATERIAL AND EQUIPMENT

4.1. Inductively coupled plasma mass spectrometer with/without collision/reaction cell.

4.2. Autosampler (optional).

4.3. 1000 μ L, 500 μ L and 100 μ L micropipettes.

4.4. 10 mL plastic, graduated test tubes with stopper.

4.5. 50 mL plastic, graduated test tubes with stopper.

4.6. Teflon coated block digestion system or water bath, for applications up to 90°C.

5. SAMPLE PREPARATION

Degas samples containing CO₂ by nitrogen bubbling (3.6), ultrasonic or other appropriate methods.

Using a micropipette (4.3), pour 5 mL of water (3.1), 500 μ L of wine, 100 to 500 μ L of HNO₃ (3.4) and 100 μ L of internal standard solution (3.9) (except for on-line, addition of the internal standard, as explained in point 3.10), into a 10 mL tube (4.4). Level off with water (3.1) and homogenize.

When the standards are prepared gravimetrically, the final dilution of the sample must also be obtained gravimetrically.

For certain elements a higher dilution may be necessary owing to their high natural content in the sample.

Special cases

A. Bromine

Br has high ionization potential and its ionization in plasma may be incomplete because of the presence of high concentrations of other elements in wines with low ionization potential. This may result in the incorrect quantification of Br and therefore a 1/50 dilution is recommended to avoid this effect (in the event of another dilution being used, confirm the results by checking recovery after an addition).

B. Arsenic

In the determination of arsenic by ICP-MS, the ethanol in the sample increases the ionization of arsenic in the plasma, resulting in an overestimation of its concentration. There are different alternatives to counteract this effect, by way of examples, the 3 following examples are given:

B.1. Using tellurium (Te) as internal standard:

Having a high ionisation energy, Te corrects the matrix effect in the determination of arsenic. Te is added to standards and samples either on-line, as explained in 3.10, or during the preparation of standards and samples, as explained in 3.11 and 5 respectively.

B.2. Addition of isopropyl alcohol to the standards and samples:

To mask the matrix effect of the wine ethanol on the ionisation of As, when preparing the sample solutions, add 200 μ L of isopropyl alcohol (3.7) before bringing it to level.

Isopropyl alcohol (3.7) must also be added to the standard solutions (3.11) to achieve the same concentration as in the sample solutions.

Alternatively, when the internal standard is added on-line using a Y-piece, the isopropyl alcohol (3.7) can be added to the internal standard solution (3.10) instead of adding it when preparing the standard and sample solutions. To calculate the concentration of isopropyl alcohol (3.7) in the final mixture, the internal diameter of the sample and the internal standard inlet tubes must be taken into account. It is recommended that the concentration of isopropyl alcohol in the final mixture is approximately 2% (v/v). The concentration of isopropyl alcohol (3.7) in the final mixture can be calculated using the following expression:

COMPENDIUM OF INTERNATIONAL ANALYSIS OF METHODS - OIV
Multielemental analysis in wine using inductively coupled
plasma- Mass spectrometry (ICP-MS)

$$C_f = C_o \times F$$

Where:

- Cf: Concentration of isopropyl alcohol (3.7) in the final mixture
- Co: Concentration of isopropyl alcohol (3.7) added to the internal standard solution (3.10)
- F: Dilution factor obtained with the following equation:

$$F = \frac{\left(\frac{DI_1}{2}\right)^2}{\left[\left(\frac{DI_2}{2}\right)^2 + \left(\frac{DI_2}{2}\right)^2\right]}$$

Where:

$\overline{DI_1}$: Internal diameter of the internal solution inlet tube

$\overline{DI_2}$: Internal diameter of the sample inlet tube

B.3. Mineralization of the sample

The following conditions are given as an example:

Sample preparation: remove the stopper carefully to ensure that the wine is not contaminated with cork debris. Wine samples are pipetted directly from the bottle without transfer to an intermediate container. Use a micropipette (4.3) to transfer 2.5 mL of wine, 2.5 mL of concentrated HNO₃ (3.4), 2 mL of water (3.1) and 500 µL of internal standard solution (3.9) into a 50 mL tube (4.4).

Wait a few minutes because an exothermic reaction can cause overflows.

The tubes are hermetically sealed or fitted with a system allowing reflux. The solutions are placed in a heating system (4.6) thermostated at 90 °C during 180 min.

Once digestion is complete, allow samples to cool to room temperature.

Bring the volume to 50 mL with water (3.1) and homogenize.

6. PROCEDURE

This procedure is given as an example.

Following the Instrument Manufacturer's instructions, switch on the device (pump working and plasma on).

Clean the system for 20 minutes using 2% (V/V) $\overline{HNO_3}$ (3.4).

COMPENDIUM OF INTERNATIONAL ANALYSIS OF METHODS - OIV
Multielemental analysis in wine using inductively coupled
plasma- Mass spectrometry (ICP-MS)

Check that the device is functioning correctly. Analyze a blank and the series of standard solutions in increasing concentrations, and the internal quality controls established by each laboratory.

Element	m/z*
Aluminium	27
Arsenic	75 / 91 (for AsO in reaction with oxygen)
Boron	11
Bromine	79
Cadmium	114
Cobalt	59
Copper	63
Strontium	88
Iron	56/57
Lithium	7
Magnesium	24
Manganese	55
Nickel	60
Lead	average of 206, 207 and 208
Rubidium	85
Sodium	23
Vanadium	51
Zinc	64

*The above table is given by way of example. Other isotopes may be required, depending on the equipment.

In the event of using equipment with no collision/reaction cell, correction equations may be necessary for some elements.

NOTE:

Spectral interferences can interfere with the quantification of certain elements. It could be:

- isobaric interference (2 elements of similar mass; ex: 115 In and 115Sn). In this case, the choice of the isotope studied must be adapted;
- interference from double charges and interference from oxides: the levels of oxides and double charges can be checked before analysis by means of control solutions, the optimization of the parameters of the apparatus (flow

COMPENDIUM OF INTERNATIONAL ANALYSIS OF METHODS - OIV Multielemental analysis in wine using inductively coupled plasma- Mass spectrometry (ICP-MS)

rate of nebulization, settings lenses, position of the torch, of the nebulizer, etc. makes it possible to reduce these interferences;

- polyatomic interferences which can be corrected through the use of correction equations or even collision/reaction cells.

7. RESULTS

The software can calculate the results directly.

The results should be expressed in the same units as the maximum limits set in the regulations.

Obtain, by interpolating in the calibration curve, the concentration of the elements in the diluted samples. Use the following equation to calculate the concentration of the elements in the sample:

$$C = \frac{C_m \times V_t}{V_m}$$

Where:

- C = Concentration of the element in the sample
- C_m = Concentration of the elements in the diluted sample
- V_t = Final volume of the measurement solution, in mL
- V_m = Aliquot volume of wine, in mL.

8. PRECISION

The results of the statistical parameters of the collaborative trial are shown in Appendix A.

Table 1 represents the % of the relative standard deviation of Repeatability and Reproducibility (RSDr% y RSDR%) of the method. (*) C = Concentration

Table 1: relative standard deviation of Repeatability and Reproducibility

Element	Concentration	RSDr %	RSDR %
Aluminium	0.25 – 5.0 mg/L	4	10
Boron	10 - 40 mg/L	3.8	6.3
Bromine	0.20– 1.0 mg/L	4.1	16.3

COMPENDIUM OF INTERNATIONAL ANALYSIS OF METHODS - OIV
Multielemental analysis in wine using inductively coupled
plasma- Mass spectrometry (ICP-MS)

	≥ 1.0 – 2.5 mg/L	2.1	8.0
Cadmium	0.001 – 0.020 mg/L	0,06 C*+0,18	10
	≥ 0.020 – 0.040 mg/L	1.5	10
Cobalt	0.002 – 0.050 mg/L	3.2	13.2
Copper	0.10 – 0.50 mg/L	3.8	11.4
	≥ 0.50 – 2.0 mg/L	2.0	11.4
Strontium	0.30 – 1.,0 mg/L	2.5	7.5
Iron	0.80– 1.0 mg/L	4.2	15.7
	≥ 1.0-5.0 mg/L	4.2	7.8
Lithium	0.010 – 0.050 mg/L	7	12
Magnesium	50 - 300 mg/L	2	6
Manganese	0.50-1.5 mg/L	3	7
Nickel	0.010 – 0.20 mg/L	5	8
Lead	0.010 – 0.050 mg/L	8	7
	≥ 0.050 – 0.20 mg/L	2	7
Rubidium	0.50 – 1.2 mg/L	3	6
Sodium	5 - 10 mg/L	2	10
	≥ 10 - 30 mg/L	0.3 C*-2.5	10
Vanadium	0.003 – 0.010 mg/L	8	10
	≥ 0.010 – 0.20 mg/L	3	10
Zinc	0.30 – 1.0 mg/L	5	12

The results of the statistical parameters of an internal validation for arsenic are shown in Appendix B.

9. BIBLIOGRAPHY

1. ISO 5725:1994, Precision of test methods-Determination of repeatability and reproducibility for a Standard test method by interlaboratory test.
2. ISO 17294:2004. Water quality — Application of inductively coupled plasma mass spectrometry (ICP-MS) — Part 1: General guidelines
3. ALMEIDA C.M.R., VASCONCELOS M.T.S.D., BARBASTE M. and MEDINA B. (2002), Anal. Bioanal Chem., 374, 314-322.
4. CASTIÑEIRA M.M., BRANDT R., VON BOHLEN A. and JAKUBOWSKI N. (2001), Fresenius J. Anal. Chem., 370, 553-558.

COMPENDIUM OF INTERNATIONAL ANALYSIS OF METHODS - OIV
Multielemental analysis in wine using inductively coupled
plasma- Mass spectrometry (ICP-MS)

5. CASTIÑEIRA M.M., BRANDT R., VON BOHLEN A., JAKUBOWSKI N. and ANDERSSON J.T. (2004), *J. Agric Food Chem.*, 52, 2962-2974.
6. ALMEIDA C.M.R. and VASCONCELOS M.T.S.D. (2003), *J. Agric. Food Chem.*, 51, 3012-3023.
7. ALMEIDA C.M.R. and VASCONCELOS M.T.S.D. (2003), *J. Agric Food Chem.*, 51, 4788-4798.
8. PÉREZ-JORDAN M.Y., SOLDEVILLA J., SALVADOR A., PASTOR A. and de la GUARDIA M. (1998), *J. Anat. At. Spectrom.*, 13, 33-39.
9. PEREZ-TRUJILLO J.-P., BARBASTE M. and MEDINA B. (2003), *Anal. Lett.*, 36(3), 679-697.
10. TAYLOR V.F, LONGERICH H.P. and GREENOUGH J.D. (2003), *J. Agric Food Chem.*, 51, 856-860.
11. THIEL G., GEISLER G., BLECHSCHMIDT I. and DANZER K. (2004), *Anal. Bioanal. Chem.*, 378, 1630-1636.

COMPENDIUM OF INTERNATIONAL ANALYSIS OF METHODS - OIV
Multielemental analysis in wine using inductively coupled plasma- Mass spectrometry (ICP-MS)

APPENDIX A RESULTS OF THE COLLABORATIVE TRIALS

The method has been checked with two collaborative trials, by evaluating precision in accordance with ISO 5725. The trueness of the method has been obtained through recovery studies.

1st Collaborative Trial

8 samples (A, B, C, D, E, F, MH1 and MH2) were used from the following origins:

- Three samples of red wine, with and without addition.
- Three samples of white wine, with and without addition.
- Two samples of synthetic hydroalcoholic mixture, prepared with ethanol and water.

Hydroalcoholic sample MH1 presented problems of instability during the trial and the results have not been taken into account.

	MH2	A	B	C	D	E	F
Metal (mg/L)	Hydroalcoholic mixture	RW2	RW3	WW2	WW3	red wine	white wine
Aluminium	5	0.5	2	2	1	No addition	No addition

COMPENDIUM OF INTERNATIONAL ANALYSIS OF METHODS - OIV
Multielemental analysis in wine using inductively coupled plasma- Mass spectrometry (ICP-MS)

Cadmium	0.001	0.005	0.02	0.05	0.01	No addition	No addition
Strontium	0.300	No addition	No addition	No addition	No addition	No addition	No addition
Lithium	0.020	0.01	0.02	0.04	0.01	No addition	No addition
Magnesium	50	100	200	50	25	No addition	No addition
Manganese	0.500	0.5	1	1	0.5	No addition	No addition
Nickel	0.070	0.025	0.2	0.1	0.1	No addition	No addition
Lead	0.010	0.05	0.1	0.15	0.05	No addition	No addition
Rubidium	1.0	No addition	No addition	No addition	No addition	No addition	No addition
Sodium	20	10	10	20	5	No addition	No addition
Vanadium	0.070	0.025	0.2	0.1	0.1	No addition	No addition
Zinc	0.010	0.05	0.1	0.15	0.05	No addition	No addition

2nd Collaborative Trial

Sixteen samples (A, B, C, D, E, F, G, H, I, J, K, L, M, N, O, P) from the following origins were used:

- Four samples of red wine, with and without addition.
- Four samples of Port wine, with and without addition.
- Six samples of white wine, with and without addition.

COMPENDIUM OF INTERNATIONAL ANALYSIS OF METHODS - OIV
Multielemental analysis in wine using inductively coupled plasma- Mass spectrometry (ICP-MS)

- Two samples of champagne.

Amounts added to the samples

Samples	Code	Addition	B	Br	Co	Cu	Fe
			mg/L	mg/L	µg/L	mg/L	mg/L
White wine	F-N	No addition	0.0	0.0	0.0	0.0	0.0
	C-I	Addition 1	5.0	0.5	5.0	5.0	1.0
	A-O	Addition 2	10.0	1.0	10.0	1.0	2.0
Liqueur wine	B-K	No addition	0.0	0.0	0.0	0.0	0.0
	E-L	Addition 3	15.0	1.5	20.0	1.5	3.0
Red wine	D-M	No addition	0.0	0.0	0.0	0.0	0.0
	H-J	Addition 4	20.0	2.0	50.0	2.0	5.0
Sparkling wine	G-P	No addition	0.0	0.0	0.0	0.0	0.0

PRECISION PARAMETERS (Tables 1 to 17):

The values of Horratr and HorratR have been obtained by using the Horwitz equation taking into account Thompson's modification for the concentration below 120 µg/L.

COMPENDIUM OF INTERNATIONAL ANALYSIS OF METHODS - OIV
Multielemental analysis in wine using inductively coupled plasma- Mass spectrometry (ICP-MS)

Table 1: Aluminium (mg/L)

SAMP LE	LAB. No.	Accepted	Assigned value	Sr	r	RSD r (%)	Horwitz RSDr (%)	Horratr	SR	R	RSDR (%)	Horwitz R RSD R (%)	HorratR
A	11	10	0.68	0.020	0.06	2.9	11	0.26	0.077	0.22	11	17	0.66
B	11	9	2.1	0.043	0.12	2.0	9.4	0.22	0.21	0.61	10	14	0.71
C	11	9	2.1	0.032	0.09	1.5	9.5	0.16	0.21	0.59	10	14	0.69
D	11	10	1.2	0.041	0.12	3.4	10	0.34	0.10	0.29	8.3	16	0.56
E	11	10	0.34	0.014	0.04	4.1	12	0.34	0.029	0.08	8.5	19	0.46
F	11	10	0.27	0.006	0.02	2.2	13	0.17	0.028	0.08	10	20	0.52
MH2	11	8	5.2	0.26	0.73	5.0	8.2	0.60	0.56	1.6	11	13	0.86

Table 2: Boron (mg/L)

SAMP LE:	LAB. No.	Accepted	Assigned	Sr	r	RSD r	Horwitz RSDr	Horrat r	SR	R	RSDR (%)	HorwitzR	Horr atR
----------	----------	----------	----------	----	---	-------	--------------	----------	----	---	----------	----------	----------

COMPENDIUM OF INTERNATIONAL ANALYSIS OF METHODS - OIV
Multielemental analysis in wine using inductively coupled plasma- Mass spectrometry (ICP-MS)

			value			(%)	(%)					RSDR (%)	
A-O	8	6	18	0.77	2.2	4.3	6.8	0.62	0.94	2.69	5.2	10	0.50
B-K	8	4	4.5	0.27	0.76	6.0	8.4	0.72	0.40	1.14	8.9	13	0.70
C-I	8	4	13	0.31	0.89	2.4	7.2	0.33	0.33	0.94	2.5	11	0.24
D-M	8	7	11	0.26	0.74	2.4	7.4	0.31	1.1	3.11	10	11	0.90
E-L	8	5	21	0.47	1.3	2.2	6.7	0.33	0.85	2.43	4.0	10	0.40
F-N	8	5	8.3	0.43	1.2	5.2	7.7	0.68	0.47	1.34	5.7	12	0.48
G-P	7	4	3.1	0.094	0.27	3.0	8.9	0.34	0.18	0.51	5.8	14	0.43
H-J	8	5	31	1.0	3.0	3.2	6.3	0.54	1.6	4.43	5.2	9.6	0.52

Table 3: Bromine (mg/L)

SAMP LE:	LAB. No.	Acc epted	Assig ned value	Sr	r	RSD r (%)	Hor witz RSD r (%)	Horrat r	SR	R	RSDR (%)	Horw itzR RSDR (%)	Horr atR
A-O	6	2	1.21	0.028	0.08	2.3	10.3	0.22	0.041	0.12	3.4	15.6	0.22

COMPENDIUM OF INTERNATIONAL ANALYSIS OF METHODS - OIV
Multielemental analysis in wine using inductively coupled plasma- Mass spectrometry (ICP-MS)

B-K	5	2	0.19	0.006	0.02	2.9	13.6	0.21	0.0043	0.012	2.3	20.5	0.11
C-I	6	3	0.81	0.017	0.05	2.1	10.9	0.19	0.062	0.18	7.7	16.5	0.47
D-M	6	4	0.38	0.017	0.05	4.5	12.2	0.37	0.066	0.19	17.4	18.5	0.94
E-L	6	3	1.72	0.030	0.09	1.7	9.7	0.17	0.22	0.62	12.8	14.8	0.86
F-N	6	3	0.22	0.014	0.04	6.4	13.3	0.48	0.046	0.13	20.9	20.1	1
H-J	6	2	2.30	0.061	0.17	2.7	9.3	0.28	0.092	0.26	4	14.1	0.28

Table 4: Cadmium (µg/L)

SAMPL E:	LA B. No.	Accepte d	As sig ne d val ue	Sr	r	RSD r (%)	Hor witz RSDr (%)	Horrat r	SR	R	RSDR (%)	Horwit zR RSDR (%)	Horra tR
A	12	11	6	0.2	0.6	3.3	15	0.22	1	3	17	22	0.77
B	12	11	16	0.4	1	2.5	15	0.17	2	6	13	22	0.59
C	12	9	40	0.4	1	1.0	15	0.07	3	8	7.5	22	0.34
D	12	10	10	0.3	0.8	3.0	15	0.20	0.9	3	9.0	22	0.41

COMPENDIUM OF INTERNATIONAL ANALYSIS OF METHODS - OIV
Multielemental analysis in wine using inductively coupled plasma- Mass spectrometry (ICP-MS)

E	8	7	0.3	0.20	0.6	67	15	4.47	0.20	0.67	67	22	3.05
F	8	6	0.3	0.04	0.1	13	15	0.87	0.20	0.45	67	22	3.05
MH2	9	5	0.9	0.08	0.2	8.9	15	0.59	0.10	0.29	11	22	0.50

Table 5: Cobalt ($\mu\text{g/L}$)

SAMPL E:	LA B. No.	Accepted	Assigned value	Sr	r	RSD r (%)	Horwitz RSDr (%)	Horrat r	SR	R	RSDR (%)	HorwitzR RSDR (%)	Horrat R
A-O	10	6	22	0.5	1	2.3	15	0.15	2	6	9.1	22	0.41
B-K	10	6	8	0.3	0.9	3.8	15	0.25	1	4	13	22	0.59
C-I	10	8	19	0.4	1	2.1	15	0.14	3	7	16	22	0.73
D-M	10	3	3	0.07	0.2	2.3	15	0.15	0.1	0.3	3.3	22	0.15
E-L	10	8	27	1	3	3.7	15	0.25	3	9	11	22	0.50
F-N	10	7	12	0.5	2	4.2	15	0.28	1	4	8.3	22	0.38
G-P	9	5	2	0.2	0.5	10	15	0.67	0.3	0.8	15	22	0.68
H-J	10	6	49	0.5	1	2.3	15	0.15	6	18	12	22	0.55

COMPENDIUM OF INTERNATIONAL ANALYSIS OF METHODS - OIV
Multielemental analysis in wine using inductively coupled plasma- Mass spectrometry (ICP-MS)

Table 6: Copper (mg/L)

SAMPL E	LAB . No.	Accept ed	Assi gne d valu e	Sr	r	RSD r (%)	Horwi tz RSDr (%)	Horrat r	SR	R	RSDR (%)	Horwit zR RSDR (%)	Horrat R
A-O	10	8	1.1	0.013	0.040	1.2	10	0.12	0.11	0.32	10	16	0.63
B-K	10	8	0.21	0.006	0.020	2.9	13	0.22	0.021	0.060	10	20	0.50
C-I	10	7	0.74	0.009	0.030	1.2	10	0.12	0.046	0.13	6.2	17	0.36
D-M	10	8	0.14	0.007	0.020	5.0	14	0.36	0.015	0.043	11	22	0.50
E-L	10	9	1.7	0.061	0.17	3.6	7.8	0.5	0.16	0.46	9.0	15	0.60
F-N	10	7	0.16	0.006	0.020	3.8	14	0.27	0.029	0.083	18	21	0.86
G-P	9	4	0.042	0.004	0.010	9.5	15	0.63	0.006	0.017	14	22	0.64

Table 7: Strontium (µg/L)

SAMP LE	LAB. N°	Accept ed	Assig ned value	Sr	r	RSD r (%)	Horwitz RSDr (%)	Horra tr	SR	R	RS DR (%)	Horw itzR RSDR	Horra tR
---------	---------	-----------	-----------------	----	---	-----------	------------------	----------	----	---	-----------	----------------	----------

COMPENDIUM OF INTERNATIONAL ANALYSIS OF METHODS - OIV
Multielemental analysis in wine using inductively coupled plasma- Mass spectrometry (ICP-MS)

												(%)	
A	12	11	1091	33	93	3.0	10	0.30	78	222	7.2	16	0.45
B	12	8	1139	66	188	5.8	10	0.58	69	195	6.1	16	0.38
C	12	9	328	6	18	1.8	13	0.14	19	54	5.8	19	0.31
D	12	10	313	7	20	2.2	13	0.17	22	61	7.0	19	0.37
E	12	10	1176	28	80	2.4	10	0.24	86	243	7.3	16	0.46
F	12	10	293	3	9	1.0	13	0.08	22	62	7.5	19	0.39
MH2	12	9	352	7	19	2.0	12	0.17	24	69	6.8	19	0.36

Table 8: Iron (mg/L)

SAMP LE	LAB. No.	Accepted	Assigned value	Sr	r	RSD r (%)	Horwitz RSDr (%)	Horrat r	SR	R	RSDR (%)	Horwitz RSDR (%)	Horrat R
A-O	10	6	3.2	0.017	0.05	0.53	8.9	0.06	0.23	0.66	7.2	13	0.55
B-K	10	6	1.5	0.085	0.24	5.7	9.9	0.58	0.11	0.31	7.3	15	0.49

COMPENDIUM OF INTERNATIONAL ANALYSIS OF METHODS - OIV
Multielemental analysis in wine using inductively coupled plasma- Mass spectrometry (ICP-MS)

C-I	10	5	2.1	0.036	0.10	1.7	9.4	0.18	0.18	0.51	8.6	14	0.61
D-M	10	5	3.1	0.033	0.094	1.1	8.9	0.12	0.29	0.83	9.4	14	0.67
E-L	10	5	4.3	0.120	0.34	2.8	8.5	0.33	0.29	0.83	6.7	13	0.52
F-N	10	6	1.1	0.051	0.15	4.6	10	0.46	0.16	0.46	15	16	0.94
G-P	9	6	0.83	0.024	0.07	2.9	11	0.26	0.14	0.40	17	16	1.06
H-J	10	7	7.8	0.180	0.52	2.3	7.8	0.29	1.2	3.52	15	12	1.25

Table 9: Lithium (µg/l)

SAMPL E	LA B. No.	Accept ed	Assi gne d valu e	Sr	r	RSD r (%)	Horwi tz RSDr (%)	Horra tr	SR	R	RSDR (%)	Horwi tzR RSDR (%)	Horr atR
A	11	10	34	2	5	5.9	15	0.39	4	11	11	22	0.50
B	11	11	42	3	8	7.1	15	0.47	4	12	10	22	0.45
C	11	11	47	1	4	2.1	15	0.14	5	13	9.8	22	0.45
D	11	11	18	1	4	5.6	15	0.37	2	7	14	22	0.64
E	11	11	25	1	3	4.0	15	0.27	3	9	12	22	0,55

COMPENDIUM OF INTERNATIONAL ANALYSIS OF METHODS - OIV
Multielemental analysis in wine using inductively coupled plasma- Mass spectrometry (ICP-MS)

F	11	9	9	0,3	1	3.8	15	0.25	0.6	2	7.2	22	0.33
MH2	11	7	22	1	3	4.6	15	0.31	1	3	5.3	22	0.24

Table 10: Magnesium (mg/L)

SAMPL E:	LA B. No.	Accept ed	Assi gne d valu e	Sr	r	RSD r (%)	Horwi tz RSDr (%)	Horra tr	SR	R	RSDR (%)	Horwi tzR RSDR (%)	Horr atR
A	10	7	182	2.9	8.1	1.6	4.3	0.37	9.3	26	5.1	7.3	0.70
B	10	6	280	3.9	11	1.4	4.5	0.31	6.0	17	2.1	6.9	0.30
C	10	7	104	2.4	6.9	2.3	5.3	0.43	6.8	19.25	6.5	8.0	0.81
D	10	6	85	1.4	4.0	1.7	5.4	0.31	2.2	6.1	2.6	8.2	0.32
E	10	7	94	2.2	6.2	2.3	5.3	0.43	5.5	16	5.9	8.1	0.73
F	10	7	65	0.95	2.7	1.5	5.6	0.27	3.8	11	5.9	8.5	0.69
MH2	10	7	51	0.90	2.5	1.8	5.8	0.31	2.4	6.9	4.7	8.9	0.53

Table 11: Manganese (mg/L)

COMPENDIUM OF INTERNATIONAL ANALYSIS OF METHODS - OIV
Multielemental analysis in wine using inductively coupled plasma- Mass spectrometry (ICP-MS)

SAMPL E	LA B. No.	Accept ed	Assi gne d valu e	Sr	r	RSD r (%)	Horwi tz RSDr (%)	Horra tr	SR	R	RSDR (%)	Horwi tzR RSDR (%)	Horr atR
A	11	10	1.3	0.014	0.040	1.1	10	0.11	0.13	0.37	10	15	0.67
B	11	9	1.8	0.14	0.40	7.8	9.7	0.80	0.20	0.56	11	15	0.73
C	11	8	1.5	0.028	0.080	1.9	9.9	0.19	0.084	0.24	5.6	15	0.37
D	11	8	1.0	0.035	0.10	3.5	11	0.32	0.049	0.14	4.9	16	0.31
E	11	9	0.84	0.019	0.050	2.3	11	0.21	0.057	0.16	6.8	16	0.43
F	11	9	0.59	0.015	0.040	2.5	11	0.23	0.031	0.090	5.3	17	0.31
MH2	11	8	0.52	0.029	0.080	5.6	12	0.47	0.037	0.10	7.1	18	0.39

Table 12: Nickel (µg/L)

SAMPL E	LA B. No.	Accept ed	Assi gne d valu e	Sr	r	RSD r (%)	Horwi tz RSDr (%)	Horra tr	SR	R	RSDR (%)	Horwi tzR RSDR (%)	Horr atR
---------	-----------	-----------	-------------------	----	---	-----------	-------------------	----------	----	---	----------	--------------------	----------

COMPENDIUM OF INTERNATIONAL ANALYSIS OF METHODS - OIV
Multielemental analysis in wine using inductively coupled plasma- Mass spectrometry (ICP-MS)

			e										
A	11	10	40	2	6	5,0	15	0.33	5	13.90	13	22	0.59
B	12	10	194	7	20	3.6	14	0.26	17	48.96	8.8	21	0.42
C	12	8	148	4	10	2.7	14	0.19	5	15.12	3.4	21	0.16
D	12	8	157	4	12	2.6	14	0.19	8	23.10	5.1	21	0.24
E	11	8	15	0.6	2	4.0	15	0.27	1	3.33	6.7	22	0.30
F	12	9	66	1	4	1.5	15	0.10	4	10.58	6.1	22	0.28
MH2	11	7	71	5	14	7.0	15	0.47	4	11.41	5.6	22	0.25

Table 13: Lead (µg/L)

SAMPL E	LA B. No.	Accept ed	Assi gne d valu e	Sr	r	RSD r (%)	Horwi tz RSDr (%)	Horra tr	SR	R	RSDR (%)	Horwi tzR RSDR (%)	Horr atR
A	12	9	59	1	4	1.7	15	0.11	3	9	5.1	22	0.23
B	12	10	109	2	6	1.8	15	0.12	8	23	7.3	22	0.33
C	12	9	136	3	9	2.2	14	0.16	13	37	9.6	22	0.44

COMPENDIUM OF INTERNATIONAL ANALYSIS OF METHODS - OIV
Multielemental analysis in wine using inductively coupled plasma- Mass spectrometry (ICP-MS)

D	12	9	119	2	6	1.7	15	0.11	5	13	4.2	22	0.19
E	12	10	13	1	3	7.7	15	0.51	1	4	7.7	22	0.35
F	12	9	92	1	4	1.1	15	0.07	4	11	4.4	22	0.20
MH2	12	10	13	1	3	7.7	15	0.51	1	3	7.7	22	0.35

Table 14: Rubidium (µg/L)

SAMPL E	LA B. No.	Accept ed	Assi gne d valu e	Sr	r	RSD r (%)	Horwi tz RSDr (%)	Horra tr	SR	R	RSDR (%)	Horwi tzR RSDR (%)	Horr atR
A	11	6	717	14	41	2.0	11	0.18	13	36	1.8	17	0.11
B	11	7	799	25	70	3.1	11	0.28	30	86	3.8	17	0.22
C	11	8	677	10	27	1.5	11	0.14	34	96	5.0	17	0.29
D	11	7	612	18	51	2.9	11	0.26	18	50	2.9	17	0.17
E	11	9	741	19	53	2.6	11	0.24	66	187	8.9	17	0.52
F	11	9	617	10	28	1.6	11	0.15	43	123	7.0	17	0.41
MH2	11	7	1128	10	28	0.89	10	0.09	64	181	5.7	16	0.36

COMPENDIUM OF INTERNATIONAL ANALYSIS OF METHODS - OIV
Multielemental analysis in wine using inductively coupled plasma- Mass spectrometry (ICP-MS)

Table 15: Sodium (mg/L)

SAMPL E	LA B. No.	Accept ed	Assi gne d valu e	Sr	r	RSD r (%)	Horwi tz RSDr (%)	Horra tr	SR	R	RSDR (%)	Horwi tzR RSDR (%)	Horr atR
A	10	9	19	0.59	1.7	3.1	6.8	0.46	2.2	5.7	12	10	1.20
B	10	9	20	1.3	3.6	6.5	6.7	0.97	2.2	6.3	11	10	1.10
C	10	7	28	0.33	0.93	1.2	6.4	0.19	1.9	5.4	6.8	9.7	0.70
D	10	8	11	0.24	0.68	2.2	7.4	0.30	1.1	3.0	10	11	0.91
E	10	8	9.8	0.19	0.53	1.9	7.5	0.25	0.89	2.5	9.1	11	0.83
F	10	8	6.1	0.093	0.26	1.5	8.1	0.19	0.74	2.1	12	12	1.00
MH2	10	8	24	1.8	5.0	7.5	6.6	1.14	2.6	7.2	11	9.9	1.11

Table 16: Vanadium (µg/L)

SAMPL E	LA B. No.	Accept ed	Assi gne d	Sr	r	RSD r (%)	Horwi tz RSDr	Horra tr	SR	R	RSDR (%)	Horwi tzR RSDR	Horr atR
---------	-----------	-----------	------------	----	---	-----------	---------------	----------	----	---	----------	----------------	----------

COMPENDIUM OF INTERNATIONAL ANALYSIS OF METHODS - OIV
Multielemental analysis in wine using inductively coupled plasma- Mass spectrometry (ICP-MS)

			valu e				(%)					(%)	
A	12	11	46	1	3	2.2	15	0.15	5	13	11	22	0.50
B	12	11	167	5	15	3.0	14	0.21	19	54	11	21	0.52
C	12	11	93	3	8	3.2	15	0.21	12	33	13	22	0.59
D	12	9	96	3	8	3.1	15	0.21	8	22	8.3	22	0.38
E	10	7	3	0.2	0.7	6.7	15	0.45	0.3	0.9	10	22	0.45
F	10	8	3	0.2	0.6	6.7	15	0.45	0.2	0.7	6.7	22	0.30
MH2	12	9	11	0.3	1	2.7	15	0.18	0.9	3	8.2	22	0.37

Table 17: Zinc (µg/L)

SAMPL E	LA B. No.	Accept ed	Assi gne d valu e	Sr	r	RSD r (%)	Horwi tz RSDr (%)	Horra tr	SR	R	RSDR (%)	Horwi tzR RSDR (%)	Horr atR
A	11	8	405	22	61	5.4	12	0.45	45	128	11	18	0.61
B	11	9	1327	49	138	3.7	10	0.37	152	429	11	15	0.73

COMPENDIUM OF INTERNATIONAL ANALYSIS OF METHODS - OIV
Multielemental analysis in wine using inductively coupled plasma- Mass spectrometry (ICP-MS)

C	11	9	990	14	41	1.4	11	0.13	86	243	8.7	16	0.54
D	11	9	1002	28	79	2.8	11	0.25	110	310	11	16	0.69
E	11	9	328	13	37	4.0	13	0.31	79	224	24	19	1.26
F	11	9	539	15	42	2.8	12	0.23	61	172	11	18	0.61
MH2	11	8	604	72	204	12	11	1.09	89	251	15	17	0.88

APPENDIX B RESULTS OF AN INTERNAL VALIDATION FOR ARSENIC
DETERMINATION OF ARSENIC IN WINE BY ICP-MS ACCORDING TO METHOD OIV/OENO
344/2010 USING TELLURIUM AS INTERNAL STANDARD

The samples were prepared and analyzed in duplicate in 5 non consecutive days. The quantitation was performed using 2 different ICP-MS.

The samples were prepared according to method OIV/OENO 344/2010, diluting 1 mL of wine in 20 mL of 3% HNO₃, without using prior mineralization in any of the samples.

Internal standard: Te, added on-line.

Results of the validation:

COMPENDIUM OF INTERNATIONAL ANALYSIS OF METHODS - OIV
Multielemental analysis in wine using inductively coupled plasma- Mass spectrometry (ICP-MS)

Product	Reference value µg/l	Result µg/l	spike µg/l	Recovery %	RSDr%	RSDR%
Red wine		<5	10	101	3.27	8.1
			200	100	0.98	3.1
			1000	102	3.1	5.8
White wine		<5	10	99	1.8	5.1
			200	102	2.8	4.7
			1000	101	2.2	5.8
Liqueur wine		<5	10	102	0.9	5.4
			200	104	1.4	5.2
			1000	103	1.1	4.4
Sparkling wine		<5	10	101	3.2	6.8
			200	101	0.8	4.3
			1000	103	4.1	5.8
*CRM red wine MAPA 2021	39.0 ± 2,17	39.77	NA	102	3.8	1.1
* ¹ CRM white wine MAPA 2021	59.5 ± 3,7	58.16	NA	98	2.0	1.9
OIV-MA-AS323-07 : R2023						

COMPENDIUM OF INTERNATIONAL ANALYSIS OF METHODS - OIV
Multielemental analysis in wine using inductively coupled plasma- Mass spectrometry (ICP-MS)

*Certified Reference Material (CRM) of red wine produced by an intercomparison test by the Spanish Ministry of Agriculture, Fisheries and Food (Ministerio de Agricultura, Pesca y Alimentación – MAPA) in 2021.

*¹Certified Reference Material (CRM) of white wine produced by an intercomparison test by the Spanish Ministry of Agriculture, Fisheries and Food (Ministerio de Agricultura, Pesca y Alimentación – MAPA) in 2021.

Method OIV-MA-AS323-08

Method type II

Assay of pesticide residues in wine following extraction using
the Quechers method

OIV-OENO 436-2012

1. INTRODUCTION

Several reference documents were used in the preparation of this analysis method, which has been validated by a laboratory [1] [2].

2 -SCOPE

This method defines the steps involved in extracting pesticide residues in wine using the QuEChERS method (*Quick Easy Cheap Effective Rugged and Safe*) and the analysis of the extracts obtained by GC/MS and/or LC/MS-MS.

3 -PRINCIPLE

The sample is extracted using acetonitrile, followed by liquid-liquid partitioning induced by adding magnesium sulphate and sodium chloride and buffering with citrate salts. The extract is then purified using an amino adsorbent (dispersive SPE with APS and magnesium sulphate). To improve their stability during storage, the extracts are acidified by adding a small quantity of formic acid. The final extract may be used directly in the determination by GC/MS and LC/MS-MS. For analyses by LC/MS-MS only, the dispersive SPE is not essential.

4. REAGENTS AND MATERIALS

4.1. General points and safety issues

Pesticides are potentially toxic, and safe handling practices must be implemented to protect the analysts, notably when preparing the stock solutions from commercially-available active ingredients.

Take all necessary precautions to prevent pesticide contamination of water, solvents, and other products.

OIV-MA-AS323-08 : 2012

COMPENDIUM OF INTERNATIONAL METHODS OF ANALYSIS - OIV
Assay of pesticide residues in wine following extraction using
the Quechers method

Unless otherwise specified, the reagents used shall be of recognised analytical quality.

4.2 Water, HPLC quality

4.3 Acetonitrile [75-05-8] HPLC quality

4.4 Methanol [67-56-1], HPLC quality

4.5 Magnesium sulphate anhydrous [7487-88-9], particles

4.6 Magnesium sulphate, anhydrous [7487-88-9], fine powder

4.7 Sodium chloride [7647-14-5]

4.8 Disodium hydrogen citrate, sesquihydrate [6132-05-4]

4.9 Trisodium citrate dihydrate [6132-04-3]

4.10 Mixture of buffer salts for the extraction step:

Weigh 4 g of anhydrous magnesium sulphate in particle form, 1 g of sodium chloride, 1 g of trisodium citrate dihydrate and 0.5 g of disodium hydrogen citrate sesquihydrate and place these reagents in a flask. The prior mixing of salts avoids the formation of crystals.

4.11 Formic acid solution in acetonitrile

Dilute 0.5 mL of formic acid up to a volume of 10 mL with acetonitrile.

4.12 Primary and secondary amine (PSA) adsorbent

For example, Bondesil-PSA® 40 µm Varian N° 12213023 1

4.13 Internal standard solutions and quality-control standard solutions

Several compounds may be used as internal standards: for example triphenylphosphate [115-86-6] and triphenylmethane [519-73-3].

Use a quality control standard to indicate the extraction efficiency of the residues from the samples: for example tris(1,3-dichloroisopropyl)phosphate or TCPP.

Solutions of a suitable concentration should be prepared.

Example: preparing the TCPPE solution at 10mg/L

Place 1 mL of stock solution containing 500 mg/L of tris(1,3-dichloroisopropyl)phosphate in a 50 mL volumetric flask and make up to volume with acetonitrile.

4.14 Calibration ranges; standard solutions containing different active ingredients

4.14.1 Standard stock solutions

Prepare stock solutions with a concentration of active ingredients of 500 mg/l in a suitable solvent (acetone for example).

Store at -18°C.

4.14.2 Surrogate solutions

A mixture of active ingredients selected to suit the equipment used (GC or LC)

and to satisfy calibration range restrictions.

4.14.3 Calibration range

Standard solutions in acetonitrile

A calibration range is prepared from surrogate solutions with the objective of obtaining a calibration line from 20 to 500 µg/l.

Standard solutions in a wine matrix

From a wine that does not contain any active ingredients, a blank matrix is prepared in accordance with protocol 6.1.1, then supplemented with increasing quantities of active ingredients in order to produce a calibration line from 20 to 500 µg/l.

5. Equipment

5.2. Glassware and volumetric laboratory equipment:

5.2.1. 100 mL stoppered flasks

COMPENDIUM OF INTERNATIONAL METHODS OF ANALYSIS - OIV
Assay of pesticide residues in wine following extraction using
the Quechers method

5.2.2. 50 mL and 12 mL single-use centrifuge tubes with screw-on stoppers

5.2.3. 10 mL class A graduated test tubes

5.2.4. 10 mL, 50 mL and 100 mL class A volumetric flasks

5.2.5. Piston-operated volumetric apparatus with delivered volumes ranging from 30 µL to 1,000 µL, checked in accordance with ISO 8655-6

5.2.6. 2 mL sampling syringes

5.3. Nylon microfilters with a pore size of 0.45 µm

5.4. Analytical balance

5.5. High-speed mixing device (such as a Vortex mixer)

5.6. Centrifuge for 50 mL and 12 mL tubes, capable of generating 3,000 g.

5.7. LC/MS-MS system, with an electrospray ionisation interface.

5.8. GC/MS system, fitted with suitable injection and detection devices (for example ion trap or triple quadrupole).

6. PROCEDURE

6.1. Preparing the samples.

6.1.1. Extraction using the QuEChERS method

Place 10 g or measure 10 mL of the sample (wine) into a centrifuge tube and add 10 mL of acetonitrile and 100 µL of a 10 mg/L solution of tris(1,3-dichloroisopropyl)phosphate. Shake vigorously for 1 minute. Pour the mixture of salts (4.10) into the centrifuge tube containing the liquid mixture.

Shake vigorously for 1 minute. Centrifuge for 5 minutes at 3,000 g.

Filter approximately 1 mL of the solution through Nylon 25 mm/45 µm filters in preparation for the LC-MS analysis.

6.1.2. Purifying the extract using an amino adsorbent (“dispersive SPE” with APS)

Place 6 mL of the acetonitrile phase described in 6.1.1. in a centrifuge tube containing 900 mg of magnesium sulphate in the form of a fine powder (4.6) and 150 mg of APS (4.12). Stopper the tube and shake vigorously for 30 s, then

OIV-MA-AS323-08 : 2012

COMPENDIUM OF INTERNATIONAL METHODS OF ANALYSIS - OIV
Assay of pesticide residues in wine following extraction using
the Quechers method

centrifuge for 5 min at 3,000 g. Without pausing, isolate and acidify the extract purified in this way by adding 50 µl of formic acid solution (4.11).

The GC-MS analysis can then be performed.

NOTE: to minimise matrix effects, a solution of “protectant” agents can be added to the sample extracts and the calibration solutions [3]

To prepare a 10 mL solution of “protectant” agents:

Weigh out 15 mg of sorbitol, 300 mg of ethylglycerol and 100 mg of gluconolactone,

Add 2mL of water

Make up to 10 mL with acetonitrile.

20 µl of this solution is added to each flask containing the calibration solutions (1 mL) and sample extracts (1 mL).

6.2. Results and Calculations

6.2.1. Identification of the residues

The residues are identified by considering certain parameters:

- their retention time
- their mass spectrum
- the relative abundance of the ion fragments (it is advisable to operate with 1 or 2 MS/MS transitions and 2 or 3 ions in MS).

6.2.2. Quantification

The extracts obtained in 6.1.1 and 6.1.2 can be analysed using various instruments, parameters and columns. However, the conditions should be adapted for each compound depending on the instruments used in order to obtain the best sensitivities.

Use the standard solutions to prepare a 5-point calibration range to check the linearity for each active ingredient.

The concentration in mg/kg (or mg/L) for each substance identified is obtained directly from the calibration line.

6.2.3. Extraction efficiency

The extraction efficiency can be checked by adding a quality-control standard to the samples, TCPF for example (see 6.1.1).

The efficiency must be between 70 and 120%.

The efficiency results are not taken into consideration when correcting the levels of residues in wines, but do allow validation of the procedure.

7. RELIABILITY OF THE METHOD

The results of the validation carried out in accordance with MA-F-AS1-08-FIDMET [4] and MA-F-AS1-09-PROPER [5], are indicated in the table below.

The average recovery rates are between 70% and 120% (the spiking levels covered a concentration range from 0.020 mg/L to 0.200 mg/L)

7.1 Repeatability (expressed in $CV_r\%$)

Repeatability (expressed as $CV_r\%$) is on average equal to 10%.

7.2 Reproducibility (expressed in $CV_R\%$)

Reproducibility (expressed as $CV_R\%$) is on average equal to 30%.

COMPENDIUM OF INTERNATIONAL METHODS OF ANALYSIS - OIV
Assay of pesticide residues in wine following extraction using
the Quechers method

	Recovery rate %.	CV _r %	CV _R %	HorRat
Metalaxyl	89	7	26	1.1
Chlorpyrifos ethyl	81	13	23	1.0
Tebuconazole	99	9	32	1.3
Cyprodinil	93	9	29	1.1
Tebufenozide	102	11	28	1.2
Fludioxonil	101	7	40	1.4
Benalaxyl	98	9	29	1.1
Cyproconazole	92	11	31	1.3
Tebufenpyrad	95	10	31	1.2
Pyraclostrobin	116	6	29	1.2
Vinclozolin	84	9	28	1.1
Mepanipyrim	82	11	30	1.1
Boscalid	95	7	28	1.1
Iprovalicarb	106	7	33	1.2
Iprodione	108	10	27	1.1
Procymidone	100	11	34	1.2
Pyrimethanil	75	12	27	1.0
Carbendazim	113	11	41	1.6
Fenbuconazole	94	6	48	2.0
Fenitrothion	90	13	36	0.7
Metrafenone	93	8	19	0.7
Penconazole	109	8	35	1.1
Flusilazole	93	8	37	1.3
Oxadixyl	86	8	37	1.3
Azoxystrobin	84	8	30	1.2
Dimethomorph	90	9	36	1.4
Fenhexamid	87	8	22	0.8

All results from inter-laboratory tests that have been conducted on reliability data are presented in **Appendix A**

8. BIBLIOGRAPHY

[1] P. Paya. J. Oliva. A. Barba. M. Anastassiades. D. Mack. I. Sigalova. B. Tasdelen; "Analysis of pesticides residues using the Quick Easy Cheap Affective Rugged and Safe (QuEChERS) pesticide multiresidue method in combination with gas and liquid chromatography and tandem mass spectroscopy detection". *Anal Bioanal Chem.* 2007.

[2] EN 15662: 2008 – Foods of plant origin - Determination of pesticide residues using GC-MS and/or LC-MS/MS following acetonitrile extraction/partitioning and clean-up by dispersive SPE – QuEChERS method; January 2009; AFNOR

[3]K. Mastovska. Steven J. Lehotay. and M. Anastassiades; "Combination of analyte protectants to overcome matrix effects in routine GC analysis of pesticides residues in food matrixes". *Anal. Chem.* 2005. 77. 8129-8137.

[4]MA-F-AS1-08-FIDMET. OIV: Reliability of Analytical Methods (resolution oeno 5/99).

[5]MA-F-AS1-09-PROPER. OIV: Protocol for the planning, performance and interpretation of performance studies pertaining to methods of analysis (resolution 6/2000).

FV 1410: Results of the inter-laboratory study

COMPENDIUM OF INTERNATIONAL METHODS OF ANALYSIS - OIV
Assay of pesticide residues in wine following extraction using
the Quechers method

APPENDIX A

RESULTS OF THE RELIABILITY STUDY

This document presents the results of the validation study on the method of assay of pesticide residues in wine following extraction using QuEChERS (FV 1340).

The study was performed in accordance with the OIV documents MA-F-AS1-08-FIDMET and MA-F-AS1-09-PROPER

1 - Participating laboratories

Sixteen laboratories took part in the study:

LABORATOIRE INTER RHONE	France
INSTITUT FUR HYGIENE UND UMWELT	Germany
LABORATORIO AGROENOLÓGICO UNIVERSIDAD CATÓLICA DEL MAULE	Chile
AGRICULTURAL OFFICE OF BORSOD-ABAUJ-ZEMPLEN COUNTY	Hungary
PESTICIDE RESIDUE ANALYTICAL LABORATORY	Hungary
AUSTRIAN AGENCY FOR HEALTH AND FOOD SAFETY	Austria
COMPETENCE CENTER FOR PLANT PROTECTION PRODUCTS	Austria
LABORATOIRE DEPARTEMENTAL DE LA SARTHE	France
LABORATOIRE PHYTOCONTROL	France
BENAKI PHYTOPATHOLOGICAL INST. PESTICIDES RESIDUES LAB.	Greece
LABORATOIRE DUBERNET OENOLOGIE	France
ARPAL DIPARTIMENTO LA SPEZIA	Italy
ARPA VENETO – SERVIZIO LABORATORI VERONA	Italy
ARPALAZIO – SEZIONE DI LATINA	Italy
ANALAB CHILE S.A.	Chile
LABORATORIO REGIONAL DE LA CCAA DE LA RIOJA	Spain
SCL LABORATOIRE DE BORDEAUX	France
ARPA – FVG DIP. DI PORDENONE	Italy

COMPENDIUM OF INTERNATIONAL METHODS OF ANALYSIS - OIV
Assay of pesticide residues in wine following extraction using
the Quechers method

2 - Samples - Active ingredients analysed

For this study, 12 samples were proposed:

- four red wines: A. B. G. H
- four white wines: C. D. I. J
- two port wines: E. K
- two muscat wines: F. L

The 27 active substances were determined across the 12 samples covering a concentration range of 0.015 mg/L to 0.200 mg/L (see table below).

	A – G <i>mg/L</i>	B – H <i>mg/L</i>	C – I <i>mg/L</i>	D – J <i>mg/L</i>	E – K <i>mg/L</i>	F – L <i>mg/L</i>
Metalaxyl	0.050	0.040	0.100	0.020		
Chlorpyrifos ethyl	0.100	0.040	0.200	0.020		
Tebuconazole	0.025	0.080	0.050	0.040		
Cyprodinil	0.050	0.040	0.100	0.020		
Tebufenozide	0.050		0.100			
Fludioxonil	0.025		0.050			
Benalaxyl	0.052	0.041	0.104	0.021		
Cyproconazole	0.054	0.086	0.108	0.043		
Tebufenpyrad	0.050	0.040	0.100	0.020		
Pyraclostrobin	0.050		0.100			
Vinclozolin		0.040		0.020	0.050	0.100
Mepanipyrim		0.080		0.040	0.025	0.050
Boscalid		0.080		0.040	0.100	0.200
Iprovalicarb					0.050	0.100
Iprodione		0.076		0.038	0.047	0.094
Procymidone		0.020		0.010		
Pyrimethanil		0.040		0.020		
Carbendazim				0.054		0.027

OIV-MA-AS323-08 : R2012

COMPENDIUM OF INTERNATIONAL METHODS OF ANALYSIS - OIV
Assay of pesticide residues in wine following extraction using
the Quechers method

Fenbuconazole		0.080		0.040		
Fenitrothion		0.040		0.020		
Metrafenone		0.040		0.020		
Penconazole		0.016		0.008		
Flusilazole		0.040		0.020		
Oxadixyl	0.050				0.025	
Azoxystrobin	0.100				0.050	
Dimethomorph	0.100				0.050	
Fenhexamid	0.100				0.050	

4 - Statistical assessment

All raw results are presented in FV 1410.

In each table, eliminated or nonsensical values appear in a different font.

4.1 Eliminated values

Some values are eliminated before evaluation in the following cases:

- to evaluate the repeatability of the method we have used the principle of double-blind samples: some laboratories only gave a single result on paired samples. this value was eliminated (noted in the tables as “**xxx**”)
- when the results are expressed in the format "less than" (noted in the tables as “**xxx**”)

The COCHRAN and GRUBBS tests were successively applied to paired samples to eliminate abnormal variances on the one hand and abnormal extreme average values on the other. The values eliminated by both these tests appear in the tables as “**xxx**”.

4.2 Repeatability - Reproducibility

The repeatability and reproducibility parameters are grouped in **Table 1**.

In this table the following items are indicated for each substance:

OIV-MA-AS323-08 : R2012

COMPENDIUM OF INTERNATIONAL METHODS OF ANALYSIS - OIV
Assay of pesticide residues in wine following extraction using
the Quechers method

- n: number of tests selected
- average: results average
- TR%: average recovery rate
- CVr%: repeatability as a % of the average
- CV_R%: reproducibility as a % of the average
- PR CV_R%: reproducibility as a % calculated using the Horwitz equation (PR CV% = $2C^{-0.1505}$)
- HoR : HorRaT value (CV_R% / PR CV_R%)

The evaluation criteria selected are:

- recovery rate between 70% and 120%
- the results obtained under reproducibility conditions are compared to those predicted according to the Horwitz model using the HorRaT value. Reproducibility values are deemed satisfactory when this ratio is less than or equal to 2
- repeatability is considered satisfactory when it does not exceed the value of 0.66 x the Horwitz reproducibility

COMPENDIUM OF INTERNATIONAL METHODS OF ANALYSIS - OIV
Assay of pesticide residues in wine following extraction using
the Quechers method

TABLE 2: Reliability values

		Red wine 1	Red wine 2	White wine 1	White wine 2	Port	Muscat
metalaxyl	n	12	13	13	11	8	
	Average	0.051	0.041	0.105	0.033	0.014	
	TR%	102	103	82	69		
	CV _r %	6	8	6	9	5	
	CV _R %	26	26	17	26	33	
	PRCV _R %	25	26	22	27	30	
	HoR	1.1	1	0.9	0.6	1.1	
chlorpyrifos	n	9	12	11	11		
	Average	0.073	0.031	0.166	0.018		
	TR%	73	78	83	90		
	CV _r %	11	16	11	15		
	CV _R %	30	27	18	18		
	PRCV _R %	24	27	21	29		
	HoR	1.3	1	0.9	0.6		
tebuconazole	n	12	14	15	14		
	Average	0.025	0.078	0.05	0.04		
	TR%	100	98	100	100		
	CV _r %	6	10	10	9		
	CV _R %	37	30	30	31		
	PRCV _R %	28	23	25	26		
	HoR	1.3	1.3	1.2	1.2		
cyprodinil	n	15	14	13	14		
	Average	0.045	0.036	0.098	0.023		
	TR%	90	90	94	96		
	CV _r %	19	6	3	3		
	CV _R %	36	34	13	31		
	PRCV _R %	26	26	23	28		
	HoR	1.4	1.3	0.6	1.1		
tebufenozide	n	10		11			
	Average	0.049		0.106			
	TR%	98		106			
	CV _r %	16		6			
	CV _R %	25		30			
	PRCV _R %	25		22			

OIV-MA-AS323-08 : R2012

COMPENDIUM OF INTERNATIONAL METHODS OF ANALYSIS - OIV
Assay of pesticide residues in wine following extraction using
the Quechers method

	HoR	1		1.3		
--	-----	---	--	-----	--	--

TABLE 2 (continued): Reliability values

		Red wine 1	Red wine 2	White wine 1	White wine 2	Port	Muscat
fludioxonil	n	10		11	10		
	Average	0.026		0.064	0.015		
	TR%	104		98	100		
	CV _r %	4		8	10		
	CV _R %	47		30	43		
	PRCV _R %	28		24	30		
	HoR	1.7		1.2	1.4		
benalxyl	n	12	12	12	12		
	Average	0.046	0.04	0.099	0.023		
	TR%	88	98	95	110		
	CV _r %	8	7	7	14		
	CV _R %	37	32	25	21		
	PRCV _R %	25	26	23	28		
	HoR	1.4	1.2	1.1	0.8		
cyproconazole	n	14	15	14	14		
	Average	0.049	0.08	0.095	0.042		
	TR%	91	93	95	98		
	CV _r %	23	7	7	7		
	CV _R %	36	32	25	33		
	PRCV _R %	25	23	23	26		
	HoR	1.4	1.4	1.1	1.3		
tebufenpyrad	n	15	14	14	12		
	Average	0.042	0.038	0.094	0.021		
	TR%	84	95	94	105		
	CV _r %	21	6	5	6		
	CV _R %	33	31	26	32		
	PRCV _R %	26	31	26	32		
	HoR	1.3	1.2	1.1	1.1		
Pyraclostrobin	n	8		9			
	Average	0.055		0.121			
	TR%	110		121			
	CV _r %	6		5			
	CV _R %	31		26			

OIV-MA-AS323-08 : R2012

COMPENDIUM OF INTERNATIONAL METHODS OF ANALYSIS - OIV
Assay of pesticide residues in wine following extraction using
the Quechers method

	PRCV _R %	25		22		
	HoR	1.2		1.2		

TABLE 2 (continued): Reliability values

		Red wine 1	Red wine 2	White wine 1	White wine 2	Port	Muscat
Vinclozolin	n		10		9	11	11
	Average		0.031		0.020	0.039	0.08
	TR%		78		100	78	80
	CV _r %		8		10	14	4
	CV _R %		35		26	27	22
	PRCV _R %		24		29	26	23
	HoR		1.4		0.9	1	0.9
Mepanipyrim	n		12		13	10	11
	Average		0.063		0.028	0.022	0.046
	TR%		79		70	88	92
	CV _r %		8		24	5	7
	CV _R %		35		36	20	28
	PRCV _R %		24		27	29	25
	HoR		1.4		1.3	0.7	1.1
Boscalid	n	11	12		11	12	11
	Average	0.022	0.097		0.034	0.083	0.174
	TR%	105	121		85	83	87
	CV _r %	12	7		6	6	4
	CV _R %	45	30		26	16	17
	PRCV _R %	28	23		27	23	21
	HoR	1.6	1.3		1	0.7	0.8
Iprovalicarb	n	11	12			13	13
	Average	0.016	0.016			0.052	0.21
	TR%	107	114			104	100
	CV _r %	9	8			5	6
	CV _R %	39	38			28	27
	PRCV _R %	30	30			25	23
	HoR	1.3	1.3			1.1	1.2
Iprodione	n		10		10	10	8
	Average		0.079		0.039	0.053	0.101
	TR%		104		103	113	107

OIV-MA-AS323-08 : R2012

**COMPENDIUM OF INTERNATIONAL METHODS OF ANALYSIS - OIV
Assay of pesticide residues in wine following extraction using
the Quechers method**

	CV _r %		10		7	10	13
	CV _R %		35		24	25	17
	PRCV _R %		23		26	25	22
	HoR		1.5		0.9	1	0.8

TABLE 2 (continued): Reliability values

		Red wine1	Red wine 2	White wine 1	White wine 2	Port	Muscat
Procymidone	n		11		11		
	Average		0.018		0.011		
	TR%		90		110		
	CV _r %		12		10		
	CV _R %		34		34		
	PRCV _R %		29		31		
	HoR		1.2		1.1		
Pyrimethanil	n		15	10	14		
	Average		0.036	0.011	0.027		
	TR%		60	46	120		
	CV _r %		9	20	7		
	CV _R %		26	31	25		
	PRCV _R %		26	31	28		
	HoR		1	1	0.9		
Carbendazim	n				8		9
	Average				0.057		0.033
	TR%				106		120
	CV _r %				11		10
	CV _R %				36		45
	PRCV _R %				25		27
	HoR				1.5		1.7
Fenbuconazole	n		8		7		
	Average		0.067		0.042		
	TR%		84		105		
	CV _r %		6		5		
	CV _R %		45		50		
	PRCV _R %		24		26		
	HoR		1.9		2		
Fenitrothion	n		11		10		
	Average		0.034		0.019		

OIV-MA-AS323-08 : R2012

COMPENDIUM OF INTERNATIONAL METHODS OF ANALYSIS - OIV
Assay of pesticide residues in wine following extraction using
the Quechers method

	TR%		85		95		
	CV _r %		16		10		
	CV _R %		31		40		
	PRCV _R %		27		29		
	HoR		1.2		1.4		

TABLE 2 (continued): Reliability values

		Red wine 1	Red wine 2	White wine 1	White wine 2	Port	Muscat
Metrafenone	n		7		7		
	Average		0.038		0.018		
	TR%		95		90		
	CV _r %		8		7		
	CV _R %		18		19		
	PRCV _R %		26		29		
	HoR		0.7		0.6		
Penconazole	n		14		13		
	Average		0.017		0.009		
	TR%		106		113		
	CV _r %		8		8		
	CV _R %		31		38		
	PRCV _R %		30		33		
	HoR		1		1.2		
Flusilazole	n		13		13		
	Average		0.035		0.019		
	TR%		88		95		
	CV _r %		6		9		
	CV _R %		37		36		
	PRCV _R %		26		29		
	HoR		1.4		1.2		
Oxadixyl	N	7				10	
	Average	0.04				0.023	
	TR%	80				92	
	CV _r %	10				5	
	CV _R %	18				31	
	PRCV _R %	26				28	
	HoR	0.7				1.1	
Azoxystrobine	N	12				13	

OIV-MA-AS323-08 : R2012

COMPENDIUM OF INTERNATIONAL METHODS OF ANALYSIS - OIV
Assay of pesticide residues in wine following extraction using
the Quechers method

	Average	0.078				0.045	
	TR%	78				90	
	CV _r %	10				6	
	CV _R %	29				31	
	PRCV _R %	23				26	
	HoR	1.2				1.2	

TABLE 2 (continued): Reliability values

		Red wine 1	Red wine 2	White wine 1	White wine 2	Port	Muscat
Dimethomorph	N	12		9	9	13	
	Average	0.086		0.019	0.019	0.047	
	TR%	86				94	
	CV _r %	6		8	14	8	
	CV _R %	30		41	44	29	
	PRCV _R %			29	29	25	
	HoR			1.4	1.5	1.2	
Fenhexamid	N	11		11	10	11	
	Average	0.083		0.026	0.025	0.039	
	TR%	83		96	93	78	
	CV _r %	7		9	10	7	
	CV _R %	31		18	19	18	
	PRCV _R %	23		28	28	26	
	HoR	1.3		0.6	0.7	0.7	

Determination of natamycin in wines

OIV-OENO 461-2012

1. INTRODUCTION

Different methods for the determination of natamycin are used based mainly on HPLC in combination with DAD or MS detection. Estimation of the performance limits - limit of detection and quantification - relies on the responsibility of the laboratories according to accreditation systems (e.g. ISO/EN 17025/2005) employing the recommendations of the OIV (OENO 7/2000, E-AS1-10-LIMDET) or other normative guidelines.

As there is lack of a reliable interlaboratory estimate of the critical level, a decision limit of 5 µg/l is temporarily adopted until a reliable interlaboratory estimate or other robust indicators of the critical level can be obtained.

2. METHODS

2.1 Determination of natamycin (pimaricin) in wine by liquid chromatography coupled to high resolution mass spectrometry

2.1.1 SCOPE

This method describes an analytical procedure for the determination of natamycin (pimaricin) in wine. The level of natamycin is expressed in micrograms per litre (µg/l) of wine. In-house validation has been carried out using solvent solutions, red wine and white wine over the concentration range 5 – 2600 µg/l.

2.1.2 PRINCIPLE

The level of natamycin in wine is determined by direct injection of the sample into a liquid chromatograph with a high-resolution mass-spectrometric detection system (LC-HR/MS). Quantification is achieved using the standard addition method. The sample is initially analysed to gain an estimated concentration of natamycin. The analysis is then repeated with standard addition calibration standards more suited to the concentration of natamycin in the sample.

2.1.3 REAGENTS

2.1.3.1 Analytes

2.1.3.1.1 Natamycin (Pimaricin) > 95%

2.1.3.2 Chemicals

2.1.3.2.1 *Methanol, HPLC Fluorescence grade (CAS no. 67-56-1).*

2.1.3.2.2 *Purified water for laboratory use, for example of EN ISO 3696 grade (water for analytical laboratory use - specification and test methods [ISO 3696:1987]).*

2.1.3.2.3 *Acetic acid, 100%, (CAS no. 64-19-7)*

2.1.3.3 Solutions

2.1.3.3.1 *Stock solution of natamycin (1000 µg/ml)*

Weigh to the nearest 0.1 mg approximately 10 mg of natamycin (2.1.3.1.1) in a 10 ml amber volumetric flask and make up to the mark with methanol:water:acetic acid (2.1.3.3.4). Cap and sonicate. Calculate the actual concentration in micrograms of natamycin per millilitre of solution.

2.1.3.3.2 *Working solution 1: natamycin (10 µg/ml)*

Pipette 100 µl of stock solution (2.1.3.3.1) into a amber 10 ml volumetric flask and make up to the mark with methanol:water:acetic acid (2.1.3.3.4)

2.1.3.3.3 *Working solution 2: natamycin (0.5 µg/ml)*

Pipette 500 µl of working solution one (2.1.3.3.2) into an amber 10 ml volumetric flask and make up to the mark with methanol:water:acetic acid (2.1.3.3.4)

2.1.3.3.4 Solution of methanol:water:acetic acid (50:47:3, v/v)

Using a measuring cylinder, measure 500 ml of methanol (3.2.1) into a 1 L volumetric flask. Add 470 ml water (2.1.3.2.2) and shake to mix. Add 30 ml acetic acid (2.1.3.2.3) and shake well.

2.1.3.3.5 Methanol, 3% acetic acid

Using a measuring cylinder add 30 ml of acetic acid (2.1.3.2.3) to a 1 L volumetric flask. Make up to the mark with methanol (2.1.3.2.1) and shake well.

2.1.3.3.6 Water, 3% acetic acid

Using a measuring cylinder add 30 ml of acetic acid (2.1.3.2.3) to a 1 L volumetric flask. Make up to the mark with water (2.1.3.2.2) and shake well.

2.1.4 APPARATUS

NOTE: An instrument or item of apparatus is listed only where it is specialised or made to a particular specification, the usual laboratory glassware and equipment being assumed to be available.

2.1.4.1 Liquid Chromatograph (LC)

Equipped with an automatic injector, a 100 µl injection loop and a high resolution mass spectrometer.

2.1.4.1.1 LC column

Capable of obtaining reproducible natamycin peaks and capable of separating the natamycin peaks from interfering peaks originating from the sample matrix and/or the solvents used.

NOTE: Depending on the type of equipment used for the analysis, the appropriate operating conditions should be optimised.

2.1.4.1.2 *HPLC analysis*

The following column and parameters have been found to be suitable:

Column:	Waters Sunfire C18, 150 x 2.1 mm, 3.5 µm	
Column temperature:	30 °C	
Flow rate:	0.25 ml/min	
Injection volume:	20 µl	
Mobile phase A:	Water:acetic acid, 97:3 (v/v)	(2.1.3.3.6)
Mobile phase B:	Methanol:acetic acid, 97:3 (v/v)	(2.1.3.3.5)
Run time:	30 min	
Autosampler tray:	8 °C	

Gradient:

Time (min)	Mobile phase A (%)	Mobile phase B (%)
0	90	10
25	10	90
27	10	90
27.1	90	10
30	90	10

2.1.4.2 Mass spectrometric detection (LC-HR/MS)

Ionisation mode:	positive electrospray
Mass resolution:	m/z/ Δ m/z
AGC target:	High dynamic range
Max Inj time:	50 ms
Scan range:	m/z 480-670
Sweep gas:	60 L/min
Aux gas:	5 L/min
Spray voltage:	3.75 V
Natamycin:	m/z 666.31069 [M+H] ⁺ .
confirmation ion m/z	503.22672
Retention time:	16.5 mins

2.1.5 **EXPERIMENTAL PROCEDURE**

Samples should be shaken to ensure homogeneity prior to sub-sampling.

2.1.5.1 Screening

For each wine pipette 2 ml of sample into two 2 ml Eppendorf centrifuge vials. Add 0 μ l, 20 μ l and of natamycin working solution 2 at 0.5 μ g/ml (2.1.3.3.3) to the vials respectively. This is equivalent to 0 μ g/l and 5 μ g/l natamycin added. Shake the vials for one minute and then centrifuge for 10 min at 14000 rpm. Filter an aliquot through 0.2 μ m PTFE into an amber 2 ml vial. Analyse by LC-HR/MS (section 6) and estimate the concentration of natamycin in the sample (section 7).

If the estimated concentration of natamycin is less than 5 μ g/l report the data as < 5 μ g/l. If the estimated concentration of natamycin is greater than 5 μ g/l follow section 5.2.

2.1.5.2 Quantitation

Natamycin determination for samples with an estimated concentration of greater than 5 µg/l. Pipette 2 ml of wine into five 2 ml Eppendorf centrifuge vials and add 0 µl, 5 µl, 10 µl, 20 µl and 50 µl of natamycin working solution 1 (2.1.3.3.2) into the vials respectively. This is equivalent to 0 µg/l, 25 µg/l, 50 µg/l, 100 µg/l and 250 µg/l natamycin added. Shake the vials for one minute and then centrifuge for 10 min at 14000 rpm. Filter an aliquot through 0.2 µm PTFE into an amber 2 ml vial. Analyse by LC-HR/MS (section 6) and estimate the concentration of natamycin in the sample (section 7).

2.1.6 ANALYSIS

NOTE: When starting measurements baseline stability and response linearity of the detector should be examined, together with verification of the detection limit. Maintain the same operating conditions throughout the measurement of all samples and calibration standards. Identify the natamycin peaks on the basis of the retention time and their accurate mass channel, and measure the peak areas. Inject each of the solutions as prepared onto the LC column. Measure the peak area of the natamycin peak in each of the quantification and confirmation channels. An example of a typical chromatogram is given in Figure 1.

Figure 1. Typical LC-HR/MS chromatogram and mass spectrum for natamycin spiked into white wine at the equivalent of 50 µg/l in the sample.

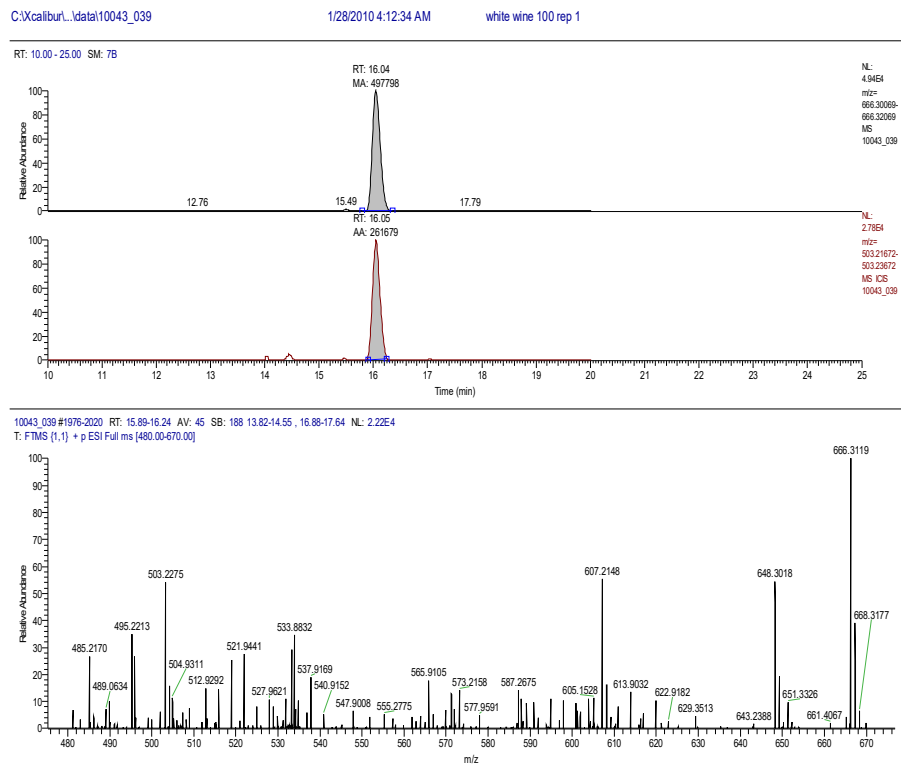

Plot the peak area for the main quantification channel against the concentration of natamycin added in micrograms per litre (µg/l). Determine the slope, intercept point and correlation coefficient of the regression line. The calibration curve shall be rectilinear and the correlation coefficient shall be 0.99 or better.

2.1.7 EXPRESSION OF RESULTS

2.1.7.1 Calculation of analyte level

The natamycin concentration in the sample in micrograms per litre ($\mu\text{g/l}$) is calculated using the following formula:

$$C = b/a$$

where C = concentration of natamycin in the wine ($\mu\text{g/l}$), a = slope of the regression line, b = y-intercept point of the regression line

2.1.8 CONFIRMATION

The presence of natamycin in the samples shall be confirmed by applying the following criteria:

The presence of a peak in both accurate mass channels m/z 666.31069 and m/z 503.22672 at the same retention time. Calculate the ratio of the peak area for the main quantification mass channel relative to the peak area of the confirmation channel. The criterion is that the ratios agree to $\pm 25\%$ of those obtained from the standard addition calibration standards.

2.1.9 METHOD PERFORMANCE DATA

2.1.9.1 Linearity

The method is linear over the calibration range of 1 to 2640 $\mu\text{g/l}$ in solvent, white wine and red wine matrices (figures 2, 3 and 4).

Figure 2. Ten point calibration graph of natamycin spiked into solvent in the range from 1 to 2600 µg/l.

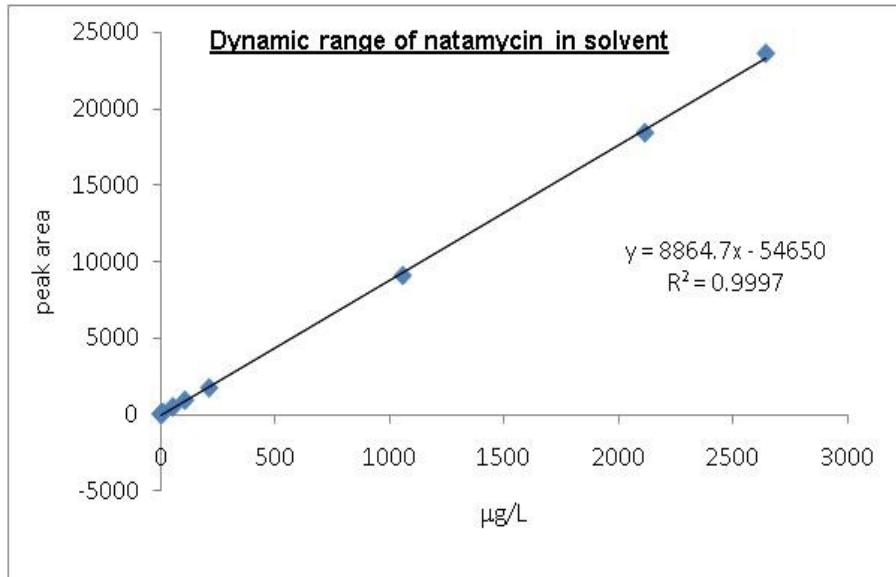

COMPENDIUM OF INTERNATIONAL METHODS OF ANALYSIS - OIV
Determination of natamycin in wines

Table 1. Solvent calibration residuals.

Natamycin (µg/l)	Predicted conc. (µg/l)	Residual s	Standard Residuals
0	6.4	-6.4	-0.4
1.056	6.8	-5.7	-0.3
5.28	10.9	-5.6	-0.3
10.56	16.8	-6.3	-0.4
52.8	58.9	-6.1	-0.3
105.6	108.3	-2.7	-0.2
211.2	200.1	11.1	0.6
1056	1029.8	26.2	1.5
2112	2084.8	27.2	1.6
2640	2671.8	-31.8	-1.8

Figure 3. Ten point calibration graph of natamycin spiked into white wine in the range from 1 to 2600 µg/l.

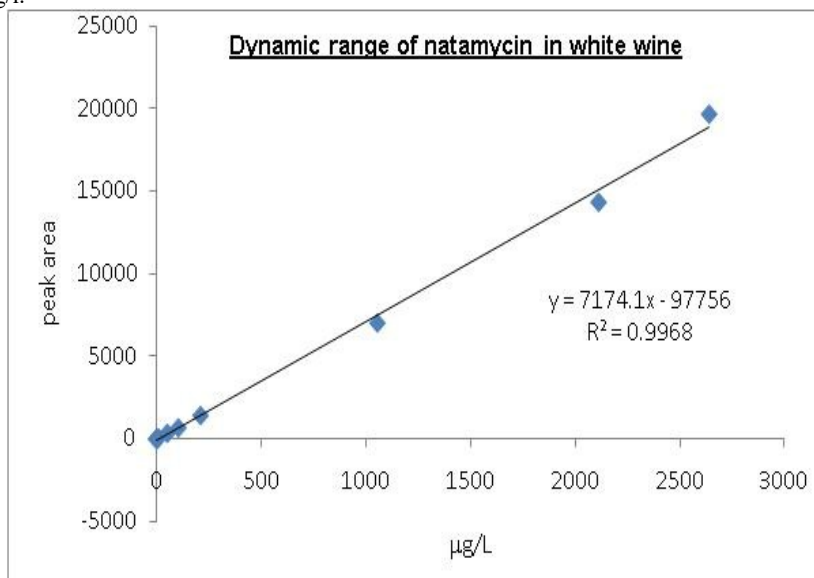

COMPENDIUM OF INTERNATIONAL METHODS OF ANALYSIS - OIV
Determination of natamycin in wines

Table 2 White wine matrix calibration residuals.

Natamycin (µg/l)	Predicted conc. (µg/l)	Residual s	Standard Residuals
0	15.5	-15.5	-0.3
1.056	15.6	-14.6	-0.3
5.28	18.8	-13.5	-0.2
10.56	23.9	-13.3	-0.2
52.8	63.6	-10.8	-0.2
105.6	109.3	-3.7	-0.1
211.2	212.8	-1.6	0.0
1056	989.0	67.0	1.2
2112	2003.2	108.8	2.0
2640	2742.7	-102.7	-1.8

Figure 4. Ten point Calibration graph of natamycin spiked into red wine in the range from 1 to 2600 µg/l.

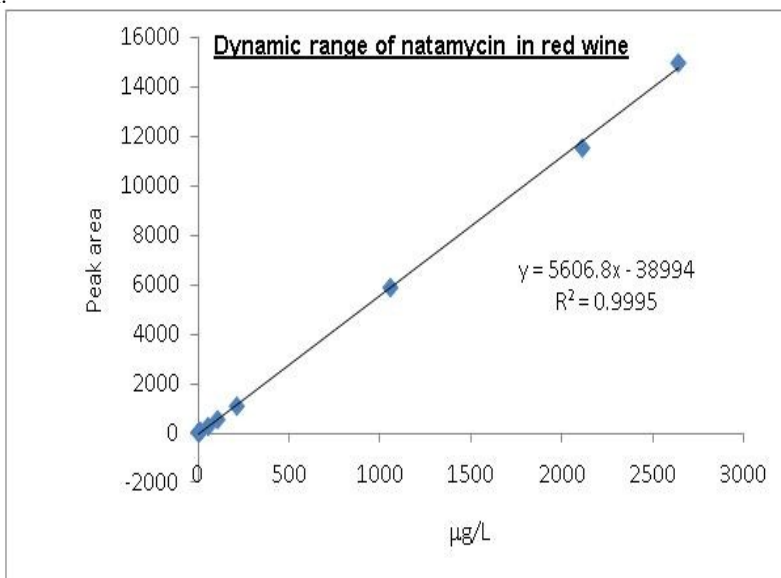

Table 3. Red wine matrix calibration residuals.

Natamycin ($\mu\text{g/l}$)	Predicted conc. ($\mu\text{g/l}$)	Residual s	Standard Residuals
0	7.2	-7.2	-0.3
1.056	8.2	-7.1	-0.3
5.28	10.9	-5.7	-0.3
10.56	16.8	-6.2	-0.3
52.8	52.1	0.7	0.0
105.6	102.1	3.5	0.2
211.2	199.8	11.4	0.5
1056	1055.2	0.8	0.0
2112	2063.7	48.3	2.3
2640	2678.4	-38.4	-1.8

2.1.9.2 Accuracy and Precision

The method was assessed for repeatability at the intervention limit of 5 $\mu\text{g/l}$ and at 200 $\mu\text{g/l}$ in solvent, white wine and red wine matrices (tables 4, 5 and 6). The accuracy was assessed by spiking a known amount at two different levels into white and red wine. The analysis was then performed by a second analyst without the knowledge of the spiked natamycin concentration. The results are shown in table 7.

Table 4. Repeatability of natamycin spiked into solvent (methanol:water:acetic acid, 50:47:3 v/v) at two concentrations; 5 and 200 µg/l.

	Conc. Natamycin ug/l	Recovery (%)
Solvent std at 5 ng/ml rep 1	5.3	99.7
Solvent std at 5 ng/ml rep 2	5.4	101.8
Solvent std at 5 ng/ml rep 3	5.8	108.6
Solvent std at 5 ng/ml rep 4	5.7	108.2
Solvent std at 5 ng/ml rep 5	5.8	109.0
Solvent std at 5 ng/ml rep 6	5.9	112.2
Solvent std at 5 ng/ml rep 7	5.7	108.4
Solvent std at 5 ng/ml rep 8	6.4	120.2
Average	5.8	108.5
Std deviation	0.3	6.2

COMPENDIUM OF INTERNATIONAL METHODS OF ANALYSIS - OIV
Determination of natamycin in wines

RSD (%)	5.7	5.7
Solvent std at 200 ng/ml rep 1	238.3	112.9
Solvent std at 200 ng/ml rep 2	237.1	112.4
Solvent std at 200 ng/ml rep 3	231.5	109.7
Solvent std at 200 ng/ml rep 4	228.0	108.1
Solvent std at 200 ng/ml rep 5	244.0	115.7
Solvent std at 200 ng/ml rep 6	220.7	104.6
Solvent std at 200 ng/ml rep 7	229.4	108.7
Solvent std at 200 ng/ml rep 8	251.7	119.3
Average	235.1	111.4
Std deviation	9.8	4.7
RSD (%)	4.2	4.2

Table 5. Repeatability of natamycin spiked into white wine at two concentrations; 5 and 200 µg/l.

	Conc. Natamycin ug/l	Recovery (%)
White wine 5.3 ng/ml rep 1	5.3	99.1
White wine 5.3 ng/ml rep 2	4.4	82.8
White wine 5.3 ng/ml rep 3	5.1	96.0
White wine 5.3 ng/ml rep 4	4.9	92.5
White wine 5.3 ng/ml rep 5	4.6	86.4
White wine 5.3 ng/ml rep 6	5.1	96.4
White wine 5.3 ng/ml rep 7	4.8	90.9
White wine 5.3 ng/ml rep 8	4.9	92.2
Average	4.9	92.0
Std deviation	0.3	5.4

COMPENDIUM OF INTERNATIONAL METHODS OF ANALYSIS - OIV
Determination of natamycin in wines

RSD (%)	5.9	5.9
White wine 211 ng/ml rep 1	217.6	103.1
White wine 211 ng/ml rep 2	223.3	105.8
White wine 211 ng/ml rep 3	213.0	101.0
White wine 211 ng/ml rep 4	216.8	102.7
White wine 211 ng/ml rep 5	211.4	100.2
White wine 211 ng/ml rep 6	208.6	98.9
White wine 211 ng/ml rep 7	204.2	96.8
White wine 211 ng/ml rep 8	214.4	101.6
Average	213.7	101.3
Std deviation	5.8	2.8
RSD (%)	2.7	2.7

Table 6. Repeatability of natamycin spiked into red wine at two concentrations; 5 and 200 µg/l.

	Conc. Natamycin ug/l	Recovery (%)
Red wine 5.3 ng/ml rep 1	5.3	99.7
Red wine 5.3 ng/ml rep 2	5.0	93.8
Red wine 5.3 ng/ml rep 3	3.8	72.5
Red wine 5.3 ng/ml rep 4	5.1	96.5
Red wine 5.3 ng/ml rep 5	5.0	95.0
Red wine 5.3 ng/ml rep 6	5.5	103.5
Red wine 5.3 ng/ml rep 7	4.3	80.9
Red wine 5.3 ng/ml rep 8	4.8	90.7
Average	4.9	91.6

COMPENDIUM OF INTERNATIONAL METHODS OF ANALYSIS - OIV
Determination of natamycin in wines

Std deviation	0.5	10.2
RSD (%)	11.1	11.1
Red wine 211 ng/ml rep 1	183.9	87.1
Red wine 211 ng/ml rep 2	178.4	84.5
Red wine 211 ng/ml rep 3	181.1	85.8
Red wine 211 ng/ml rep 4	197.5	93.6
Red wine 211 ng/ml rep 5	178.2	84.5
Red wine 211 ng/ml rep 6	184.2	87.3
Red wine 211 ng/ml rep 7	181.2	85.9
Red wine 211 ng/ml rep 8	171.3	81.2
Average	182.0	86.2
Std deviation	7.5	3.6
RSD (%)	4.1	4.1

Table 7. Accuracy of natamycin spiked into white and red wine at two concentrations; 125 and 220 µg/l.

	Theoretical concentration (µg/l)	Obtained concentration (µg/l)	Accuracy (%)	Z Score
White wine A rep 1	125	135	108	0.50
White wine A rep 2	125	142	114	0.85
White wine A rep 3	125	138	110	0.65
White wine B rep 1	220	230	105	0.28
White wine B rep 2	220	230	105	0.28
White wine B rep 3	220	239	109	0.54

COMPENDIUM OF INTERNATIONAL METHODS OF ANALYSIS - OIV
Determination of natamycin in wines

Red wine A rep 1	220	213	97	-0.20
Red wine A rep 2	220	234	106	0.40
Red wine A rep 3	220	223	101	0.09
Red wine B rep 1	125	129	103	0.20
Red wine B rep 2	125	129	103	0.20
Red wine B rep 3	125	120	96	-0.25

Calculations

Z scores calculated as:

= (obtained concentration - theoretical concentration)/ target standard deviation

Where:

Target standard deviation = 0.16 x spiked concentration

i.e according to Horwitz

2.2 ***Détermination of natamycin (pimaricin) in wine by HPLC/DAD***

2.2.1 ***Scope***

This method describes an analytical procedure for the determination of natamycin (pimaricin) in wine by HPLC. The level of natamycin is expressed in micrograms per litre (µg/l) of wine.

The described method has been laboratory validated taking into account the influence of the matrix wine (e.g. white wine or red wine).

2.2.2 ***Principle***

Non-sparkling wine samples are directly injected into the HPLC system. Sparkling wine samples are degassed first by filtration or by using an ultrasonic bath. The analyte is separated from the matrix on a C8-column. The fraction window with the analyte is automatically transferred to a C18-column for further separation. Natamycin is detected at 304 nm and 319 nm. Additionally the DAD spectrum is used for identification. Quantification is done with reference to external standards.

2.2.3 ***Reagents and Material***

2.2.3.1 **Reagents**

2.2.3.1.1 Water, deionised

COMPENDIUM OF INTERNATIONAL METHODS OF ANALYSIS - OIV
Determination of natamycin in wines

- 2.2.3.1.2 Methanol, HPLC grade (CAS no. 67-56-1).
- 2.2.3.1.3 Formic acid, p. a. (CAS no. 64-18-6).
- 2.2.3.1.4 Acetic acid, p. a. (CAS no. 64-19-7).
- 2.2.3.1.5 Hydrochloric acid, p. a., 0,1 N (CAS no. 7647-01-0).
- 2.2.3.1.6 Matrix wine, natamycin not detectable
- 2.2.3.1.7 Natamycin, > 95 % (CAS no. 7681-93-8).

The purity is verified by photometric measurement at 291 nm, 304 nm and 319 nm of a natamycin solution in hydrochloric acid, 0,1 N against a blank of hydrochloric acid, 0,1 N:

Reference data according to the literature	291 nm	304 nm	319 nm
Extinction (1 Gew.% Natamycin, 1 cm cell)	758	1173	1070

Alternative:

After dilution (e. g. dilution factor 20) the stock solution (2.1.3.3.1.) can also be used for the photometric measurement, e. g. pipette 1,0 ml stock solution into a 20 ml volumetric flask and fill up to the mark with hydrochloric acid, 0,1 N. Measure against a blank with the same composition of solvents as the diluted stock solution.

2.2.3.2 Preparation of the mobile phase

2.2.3.2.1 Solutions for the mobile phase:

2.2.3.2.1.1 5 ml acetic acid added to 2 l methanol

2.2.3.2.1.2 5 ml acetic acid added to 2 l deionised water

2.2.3.2.2 Eluent 1: methanol-acetic acid / deionised water-acetic acid (65 / 35)

COMPENDIUM OF INTERNATIONAL METHODS OF ANALYSIS - OIV
Determination of natamycin in wines

2.2.3.2.3 Eluent 2: methanol-acetic acid / deionised water-acetic acid (80 / 20)

2.2.3.3 Preparation of the stock and standard solutions

All solutions have a limited stability and have to be stored dark and cold in a refrigerator. The stock solution (2.1.3.3.1.1) has a shelf life up to several weeks but the concentration has to be checked shortly before usage (e.g. see alternative method, 2.2.3.1.7.). Dilution I (2.2.3.3.1.2) and II (2.2.3.3.1.3) and the standard solutions (2.2.3.3.2) have to be prepared daily.

2.2.3.3.1 Preparation of the stock solution and dilutions

2.2.3.3.1.1 Stock solution (approximately 100 mg/l)

Weight in about 5 mg natamycin (3.1.7) and transfer with methanol into a 50 ml volumetric flask. Add 0,5 ml formic acid, make sure that all the natamycin is dissolved, temperate at 20 °C and make up to the mark with methanol.

2.2.3.3.1.2 Dilution I (approximately 5 mg/l)

Pipette 2,5 ml of the stock solution (2.1.3.3.1.1) into a 50 ml volumetric flask and make up to the mark with deionised water.

2.2.3.3.1.3 Dilution II (approximately 1 mg/l)

Pipette 4 ml of Dilution I (2.2.3.3.1.2) into a 20 ml volumetric flask and make up to the mark with the matrix wine (2.2.3.1.6).

2.2.3.3.2 Preparation of the standard solutions

For the standard solutions dilute Dilution II (2.2.3.3.1.3) to the desired concentrations with the matrix wine (2.2.3.1.6), e. g. 50 µl into a 10 ml volumetric flask equals 5 µg/l:

Volumetric flask	10 ml	10 ml	10 ml	10 ml	10 ml	10 ml	10 ml
Volume of Dilution II (µl)	50	100	200	400	500	1000	3700
Amount of natamycin (µg/l)	5	10	20	40	50	100	370

2.2.4 Apparatus

Usual laboratory equipment, in particular the following:

- 2.2.4.1 HPLC-DAD apparatus with a 6 port HPLC valve and two isocratic pumps or a gradient pump to enable fractionation
- 2.2.4.2 HPLC-column RP-8
- 2.2.4.3 HPLC-column RP-18
- 2.2.4.4 Photometer

2.2.5 Sampling

Non-sparkling wine samples are directly injected into the HPLC system. Sparkling wine samples are first degased by filtration or by using an ultrasonic bath. If samples need to be stored the storage conditions should be cold and dark.

2.2.6. Procedure

2.2.6.1. Operating conditions of HPLC

The following columns and parameters have been found to be suitable:

Column 1: C 8-column (e.g. Select B 125*4mm/5µm endcapped, Merck)

Mobile phase: Eluent 1 (2.2.3.2.2) at room temperature

Flow rate: 1 ml/min

Column 2: C 18-column (e.g. Lichrospher 125*4mm/5µm, Merck)

Mobile phase: Eluent 2 (2.2.3.2.3) at 30°C

Flow rate: 1 ml/min

Injection volume: 500 µl

UV-detection: 304 nm and 319 nm

Fraction window: The position of the fraction window has to be checked prior to the following analysis (fig. 1). The range of the fraction window has to be set at 0,5 min. before and after the desired peak elutes from the C 8-column.

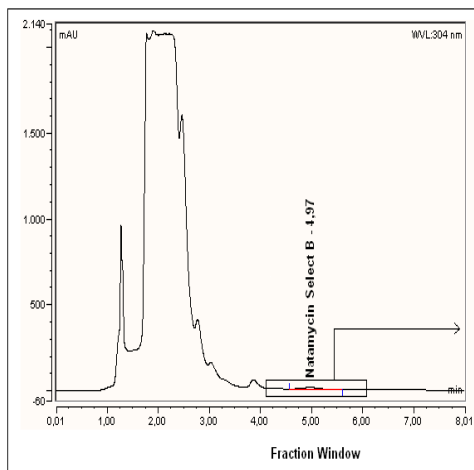

Fig. 1 Column 1
Fraction window

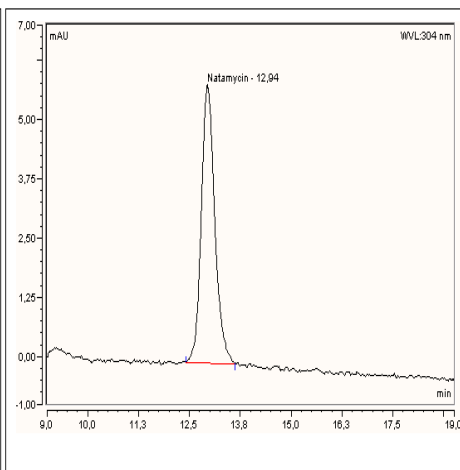

Fig. 2 Column 2
White wine spiked with natamycin (50 µg/l)

2.2.6.2 Identification/ Confirmation

Identification of peaks is done by the comparison of retention times between standards and samples for both measured wavelengths 304 nm and 319 nm. Using the chromatographic system and parameters of 2.2.6.1 the retention time for natamycin is approximately 12,9 min (fig. 2).

The DAD spectrum is used for further confirmation of positive findings (fig. 3 and fig. 4).

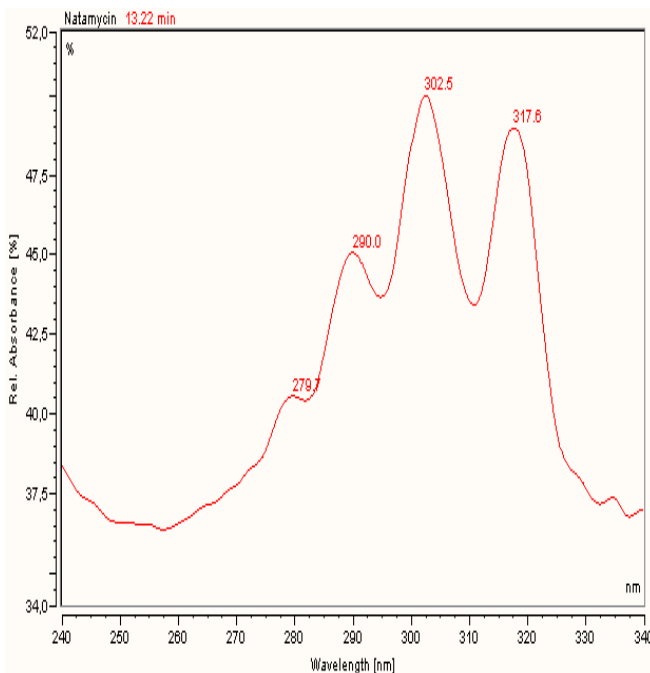

Fig. 4 DAD spectra of natamycin
natamycin

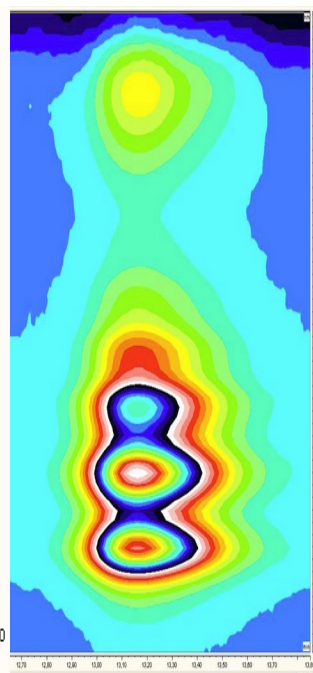

Fig. 3 3D-DAD spectra of
natamycin

2.2.7. Calculation and expression of results

A calibration curve of the standard solutions (2.2.3.3.2) is prepared using the chromatograms measured at 304 nm. The quantification of natamycin is performed following the external calibration method. A linear calibration curve is generated by comparison of the peak areas and the relevant concentrations. The correlation coefficient should be at least 0,99.

The expression of the results is $\mu\text{g/l}$.

2.2.8. Method performance data

Detection limit, Quantification limit

The detection limit and quantification limit were determined according to DIN 32645 (direct determination: multiple measurement of a blank matrix sample, $n=10$, and a calibration curve that covers the total working range).

Detection limit: $2,5 \mu\text{g/l}$

Quantification limit: $8,5 \mu\text{g/l}$

Linearity

The linearity in a wine matrix is confirmed in the calibration range of 5 µg/l to 100 µg/l (fig. 5).

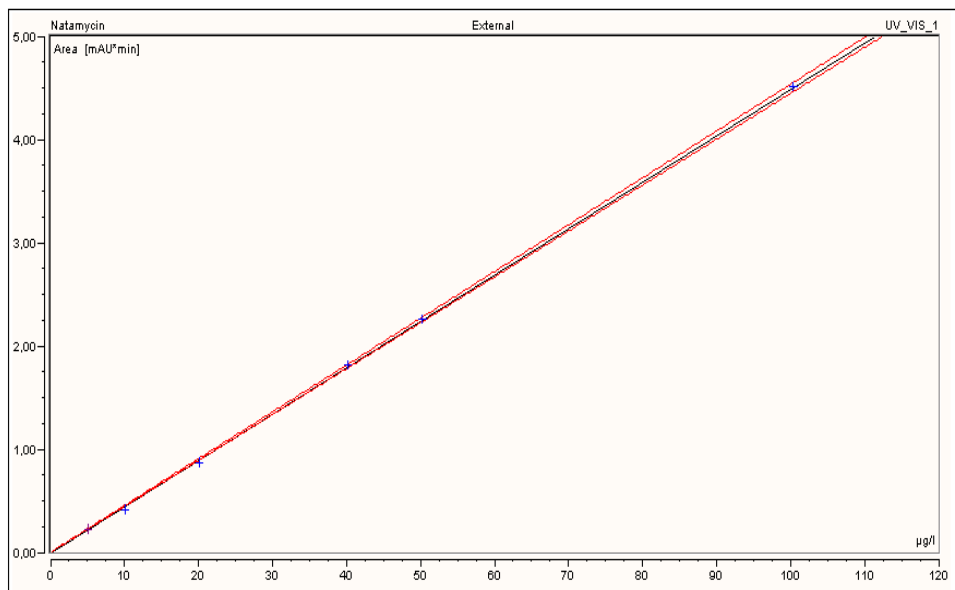

Fig. 5 Six point calibration graph of natamycin spiked into white wine matrix in the range from 5 to 100 µg/l, $R^2=0,9999$

2.2.9 Trueness and Precision

Trueness and repeatability were assessed by spiking a known amount of natamycin into white, rosé and red wine and measuring each of these samples five times. The results are shown in table 1.

Matrix	Natamycin	Spiked	Measured	Recovery	Z-
--------	-----------	--------	----------	----------	----

COMPENDIUM OF INTERNATIONAL METHODS OF ANALYSIS - OIV
Determination of natamycin in wines

	content in matrix (µg/l)	natamycin content (µg/l)	natamycin content (µg/l)	rate (%)	Score
White wine	n. d.	5.02	5.04	100.4	0.0
			4.70	93.6	-0.2
			5.12	102.0	0.1
			5.29	105.4	0.2
			4.97	99.0	0.0
		Average	5.02	100.1	
		Std dev.	0.22		
		RSD (%)	4.3		
		Repeatability r	0.85		
Rosé wine	n. d.	5.02	4.79	95.4	-0.1
			4.83	96.2	-0.1
			4.76	94.8	-0.1
			4.79	95.4	-0.1
			4.73	94.2	-0.2
		Average	4.78	95.2	
		Std dev.	0.04		
		RSD (%)	0.78		
		Repeatability r	0.15		
Red wine	n. d.	5.02	4.61	91.8	-0.2
			4.65	92.6	-0.2
			4.89	97.4	-0.1
			4.67	93.0	-0.2
			4.34	86.5	-0.4
		Average	4.63	92.3	
		Std dev.	0.20		
		RSD (%)	4.2		
		Repeatability r	0.77		
Red wine	n. d.	21.2	19.73	93.1	-0.2
			20.66	97.5	-0.1
			21.16	99.8	0.0
			19.73	93.1	-0.2
			19.58	92.4	-0.3
		Average	20.17	95.2	
		Std dev.	0.70		
		RSD (%)	3.5		
		Repeatability r	2.7		
Red wine	n.d.	53.2	51.84	97.4	-0.1
			51.91	97.6	-0.1

COMPENDIUM OF INTERNATIONAL METHODS OF ANALYSIS - OIV
Determination of natamycin in wines

			51.42	96.7	-0.1
			50.12	94.2	-0.2
			50.62	95.2	-0.2
		Average	51.18	96.2	
		Std dev.	0.78		
		RSD (%)	1.5		
		Repeatability r	3.1		

Table 1 Accuracy of natamycin spiked into white, rosé and red wine; n.d. “not detected”. detection limit 2.5 µg/l

Calculations (Table 1):

$$\text{Repeatability } r = \text{Std dev.} * t_{4;0.95} * 2^{1/2}$$

$$Z \text{ score} = (\text{measured amount} - \text{spiked amount}) / \text{target standard deviation} *$$

* according to Horwitz

$$\text{target standard deviation} = 1/100 * \text{spiked amount} * 2^{(1 - 0.5 \log \text{spiked amount})}$$

References

DIN 32645:2008-11

UV- und IR-Spektren wichtiger pharmazeutischer Wirkstoffe. Editio Cantor Aulendorf. 1978. Herausgeber/ Editor Hans-Werner Dibbern in Zusammenarbeit mit E. Wirbitzki

Macarthur R. Feinberg M. Bertheau Y. 2010. Construction of measurement uncertainty profiles for quantitative analysis of genetically modified organisms based on interlaboratory validation data. Journal of the Association of Official Analytical Chemists. 93(3). 1046 – 1056.

FV 1351. Dominic Roberts and Adrian Charlton. Determination of natamycin in wine by liquid chromatography coupled to high resolution mass spectrometry: standard operating procedure and method performance data. OIV SCMA March 2010.

FV 1355. Tomasz Brzezina. Natamycin in Wein. OIV SCMA March 2010.

Method of determination of phthalates
by gas chromatography / mass spectrometry in wines

OIV-OENO 477-2013

OIV-OENO 596-2019

1. SCOPE

This method applies to the detection and assay of phthalates in wines.

2. PRINCIPLE

The sample is extracted using isohexane. The extract is concentrated by evaporation. The concentrated extract is analysed by gas chromatography/mass spectrometry (GC/MS) with deuterated internal standards.

3. REAGENTS AND MATERIALS

Unless otherwise specified, all the reagents used are of recognised analytical quality.

- 3.1 DMP (dimethyl phthalate) [CAS N°: 131-11-3]
- 3.2 DnBP (dibutyl phthalate) [CAS N°: 84-74-2]
- 3.3 DEHP (bis (2-ethylhexyl) phthalate) [CAS N°: 117-81-7]
- 3.4 BBP (butyl benzyl phthalate) [CAS N°: 85-68-7]
- 3.5 DINP (di-isononyl phthalate) [CAS N°: 068515-48-0/028553-12-0]
- 3.6 DIDP (di-isodecyl phthalate) [CAS N°: 068515-49-1/026761-40-0]
- 3.7 DCHP (dicyclohexyl phthalate) [CAS N°: 84-61-7]
- 3.8 DEP (diethyl phthalate) [CAS N°: 84-66-2]
- 3.9 DiBP (di-isobutyl phthalate) [CAS N°: 84-74-2]
- 3.10 DnOP (di-n-octyl phthalate) [CAS N°: 117-84-0]
- 3.11 DMP-d4: internal standard [CAS N°: 93951-89-4]
- 3.12 DEP-d4: internal standard [CAS N°: 93952-12-6]
- 3.13 DiBP-d4: internal standard [CAS N°: 358730-88-8]
- 3.14 DnBP-d4: internal standard [CAS N°: 93952-11-5]

COMPENDIUM OF INTERNATIONAL METHODS OF ANALYSIS - OIV
Method of determination of phthalates
by gas chromatography / mass spectrometry in wines

- 3.15 BBP-d4: internal standard [CAS N°: 93951-88-3]
- 3.16 DCHP-d4: internal standard [CAS N°: 358731-25-6]
- 3.17 DEHP-d4: internal standard [CAS N°: 93951-87-2]
- 3.18 DnOP-d4: internal standard [CAS N°: 93952-13-7]
- 3.19 Isohexane [CAS N°: 107-83-5] and Acetone [CAS N°: 67-64-1]

3.20 Standard solutions

All the volumetric flasks used to prepare the calibration solutions are to be rinsed with acetone then isohexane to avoid any contamination.

3.20.1. Stock solutions

- Phthalate - 1 g/L individual solution: for each phthalate weigh 100 mg into a 100 mL flask, dissolve in the isohexane and make up to 100 mL.
- DINP-DIDP - 5 g/L individual solution: for each phthalate weigh 500 mg into a 100 mL flask, dissolve in the isohexane and make up to 100 mL.
- Internal standard - 0.5 g/L individual solution: deuterated standards are packaged in sealed 25 mg ampoules; for each internal standard, all the contents of the bulb are transferred into a 50 mL volumetric flask; make up to 50 mL with isohexane.

3.20.2. Working solutions

- Phthalate 1 mg/L working solution (S1)
Take 100 µL of each 1 g/L and 5g/L stock solution (3.20.1), add the samples to a 100 mL flask, and make up to 100 mL with isohexane.
- Phthalate 10 mg/L working solution (S2)
Take 1 mL of each 1 g/L and 5g/L stock solution (3.20.1), add the samples to a 100 mL flask, and make up to 100 mL with isohexane.

COMPENDIUM OF INTERNATIONAL METHODS OF ANALYSIS - OIV
Method of determination of phthalates
by gas chromatography / mass spectrometry in wines

- Internal standard 10 mg/L working solution (IS)

Take 1 mL of each deuterated standard 0.5 g/L stock solution (3.20.1), add the samples to a 50 mL flask, and make up to 50 mL with isohexane.

3.20.3. Calibration range

The calibration range in isohexane is prepared from the various working solutions (3.20.2), directly into the injection vials that have been heat-treated, rinsed (see § 5.1) and dried under a hood beforehand, according to the following table:

Calibration points	Phthalate concn. (mg/L)*	Vol. of S1 surrogate soln. (µL)	Vol. of S2 surrogate soln. (µL)	Vol. of IS surrogate soln. (µL)	Vol. of isohexane (µL)
C1	0	0	0	50	1000
C2	0,05	50	0	50	950
C3	0,10	100	0	50	900
C4	0,20	200	0	50	800
C5	0,50	0	50	50	950
C6	0,80	0	80	50	920
C7	1,00	0	100	50	900

* to be multiplied by 5 for DINP and DIDP concentrations

4. EQUIPMENT

4.1 Glassware and volumetric laboratory equipment:

4.1.1 50 mL and 100 mL class A volumetric flasks

4.1.2 50 mL glass centrifuge tubes with stopper

4.1.3 10 mL glass test tubes with stopper

4.1.4 Micropipettes with variable volumes ranging from 25 µl to 1,000 µl, checked in accordance with ISO 8655-6

4.1.5 Nitrogen flow evaporator

COMPENDIUM OF INTERNATIONAL METHODS OF ANALYSIS - OIV
Method of determination of phthalates
by gas chromatography / mass spectrometry in wines

4.2 Analytical balance

4.3 GC-MS System (e.g. Varian 450GC-300MS)

5. PROCEDURE

5.1 Precautions

Due to the presence of phthalates in the laboratory environment, precautions must be taken throughout the analysis of these compounds:

- Avoid any contact with plastic equipment (especially flexible PVC) as much as possible. If this is not possible, make sure there is no contamination.
- Test the solvents used and dedicate bottles of solvent to these analyses.
- Heat-treat all non-volumetric glassware (400°C for at least 2 hours). Rinse all the equipment carefully (with acetone then isohexane).
- Make sure the septums of the injection vials are phthalate-free.
- Before and after each injection, rinse the injection syringe several times.
- If possible, work in a clean room or in a room reserved for these analyses.

5.2 Preparing the samples

Place 12.5 mL of the sample in a 50 mL centrifuge tube. Add 10 mL of isohexane.

Shake vigorously (Vortex mixer) for at least one minute.

Let the mixture decant until the 2 phases have separated (30 minutes in a 50°C ultrasound bath will accelerate the separation). Recover 8 mL of the organic phase and transfer it into a 10 mL test tube. Evaporate under a flow of nitrogen (0.3 bar) at 35°C and avoid continuing to dryness (warning: the temperature must not exceed 40°C)

Resume with 1 mL of isohexane.

Add 50 µl of the 0.01 g/L internal standard solution to each extract.

Transfer into an injection vial.

NOTE: to minimise matrix effects during analysis by GC-MS, a “protective” agent can be added, such as methyl undecanoate [CAS N°: 1731-86-8].

COMPENDIUM OF INTERNATIONAL METHODS OF ANALYSIS - OIV
Method of determination of phthalates
by gas chromatography / mass spectrometry in wines

Add 20µL of this compound is added to each calibration solution and to the extracts from the samples prior to evaporation under a flow of nitrogen.

5.3 Blank test

Prepare a “blank” test by following the procedure described in 5.2 without adding the sample.

5.4 GC/MS analysis

Depending on the apparatus available and its performance, choose between SIM and MRM modes for the mass spectrometry.

For information purposes, analysis conditions are provided in Appendix I and a typical chromatogram is provided in Appendix II.

5.4.1 Calibration

First, carry out several solvent injections (at least 2). Next, inject the standard solutions (3.20.3) in duplicate in increasing order of concentration and end with at least two solvent injections.

Establish a calibration curve for each phthalate:

$$(A_{\text{analyte}}/A_{\text{IS}}) = f(C_{\text{analyte}}/C_{\text{IS}}).$$

A: peak area

C: concentration

IS: internal standard

Each phthalate is quantified using to the corresponding deuterated standard, with the exception of DINP and DIDP which are quantified using to DnOP-d4.

5.4.2 Analysing the samples

COMPENDIUM OF INTERNATIONAL METHODS OF ANALYSIS - OIV
Method of determination of phthalates
by gas chromatography / mass spectrometry in wines

Start the analysis sequence by analysing the "blank" test (5.3).
Then inject the samples prepared (5.2) in duplicate.
Plan solvent injections after potentially highly contaminated samples.

End the series by injecting one or more calibration standards to check any signal drift during the analysis series and to check several solvent injections..

For each injection, measure the area of the identified peaks and internal standards, and use the calibration curve equation (5.4.1) to determine the concentration in the extract analysed.

5.4.3 Expressing the results

For each sample, calculate the average of the results obtained (5.4.2) for both injections.

The results are expressed in mg/L.

6. QUALITY CONTROL

During each analysis series, quality control is provided by the analysis of a wine sample supplemented with phthalates at a concentration level of 0.020 mg/L.

The extract of the sample prepared as per 5.2 is analysed at the beginning of the series, and the results obtained, given in terms of recovery rate, are reflected on a control chart.

7. METHOD CHARACTERISTICS

The analyses performed in the laboratory, under repeatability and intermediate precision conditions, on a red wine and a white wine supplemented with phthalates at two concentration levels (0.040 mg/L and 0.080 mg/L), gave the following repeatability ($CV_r\%$), intermediate reproducibility ($CV_{IP}\%$), and recovery values:

	Recovery %	CV _r %	CV _{IP} %
--	------------	-------------------	--------------------

COMPENDIUM OF INTERNATIONAL METHODS OF ANALYSIS - OIV
Method of determination of phthalates
by gas chromatography / mass spectrometry in wines

Phthalates			
DMP (dimethyl phthalate)	67	5	8
DEP (diethyl phthalate)	84	8	11
DiBP (di-isobutyl phthalate)	93	7	10
DnBP (dibutyl phthalate)	95	5	7
BBP (butyl benzyl phthalate)	98	5	6
DCHP (dicyclohexyl phthalate)	97	5	7
DEHP (bis(2-ethylhexyl) phthalate)	98	6	7
DnOP (dioctyl phthalate)	98	6	7
DINP (di-isononyl phthalate)	104	7	8
DIDP (di-isodecyl phthalate)	96	8	11

i.e. the following average values for all the phthalates:

Repeatability (given in $CV_r\%$): **6%**

Intermediate precision (given in $CV_{IP}\%$): **8%**

8. DETECTION AND QUANTIFICATION LIMITS

For each phthalate being analysed for, the detection and quantification limits are provided in the following table:

	Quantificatio	Detection

COMPENDIUM OF INTERNATIONAL METHODS OF ANALYSIS - OIV
Method of determination of phthalates
by gas chromatography / mass spectrometry in wines

Phthalates	n limit (mg/L)	limit (mg/L)
DMP (dimethyl phthalate)	0.010	0.004
DEP (diethyl phthalate)	0.010	0.004
DiBP (di-isobutyl phthalate)	0.010	0.004
DnBP (dibutyl phthalate)	0.010	0.004
BBP (butyl benzyl phthalate)	0.010	0.004
DCHP (dicyclohexyl phthalate)	0.010	0.004
DEHP (bis(2-ethylhexyl) phthalate)	0.010	0.004
DnOP (dioctyl phthalate)	0.010	0.004
DINP (di-isononyl phthalate)	0.050	0.020
DIDP (di-isodecyl phthalate)	0.050	0.020

9. REFERENCES

- FV 1371. Detection and assay of phthalates in alcoholic beverages. 2011
FV 1234. Questions about phthalates. 2006

APPENDIX I

COMPENDIUM OF INTERNATIONAL METHODS OF ANALYSIS - OIV
Method of determination of phthalates
by gas chromatography / mass spectrometry in wines

(for information)

Gas chromatography conditions

VF-5ms type capillary column: 30 m x 0.25 mm internal diameter, film thickness 0.25 µm

Temperature programming:

For detection in SIM mode:

Oven maintained at 100°C for 1 min; increase to 230°C at a rate of 10°C/min; increase to 270°C at a rate of 10°C/min; maintain for 2 min, increase to 300°C at a rate of 25°C/min; maintain for 8 min.

Note: this programming separates the DEHP and DCHP peaks (which cannot be done with the MRM mode programming)

For detection in MRM mode:

Oven maintained at 80°C for 1 min; increase to 200°C at a rate of 20°C/min; increase to 300°C at a rate of 10°C/min; maintain for 8 min.

Injector: maintained at 150°C for 0.5 min; increase to 280°C at a rate of 200°C/min, in splitless mode at injection

Helium: 1 mL/min at a constant flow rate

Volume injected: 1 µL

Mass spectrometry (MS) conditions

Ionisation in EI mode at 70 eV

Source temperature: 250°C

Transfer line temperature: 300°C

Manifold: 40°C

Phthalate quantification and identification parameters

COMPENDIUM OF INTERNATIONAL METHODS OF ANALYSIS - OIV
Method of determination of phthalates
by gas chromatography / mass spectrometry in wines

For an analysis in SIM mode, table 1 provides the quantification ion and the two qualifier ions for each phthalate and its deuterated homologue.

For an analysis in MRM mode, table 2 reflects the quantifying and qualifying transitions for each phthalate and its deuterated homologue.

Note: DIDP and DINP are each a mixture of compounds. Chromatography cannot separate them completely. They are therefore assayed as a "group".

APPENDIX I
(for information)
Table 1

		Quantification ion m/z	Qualifier ions m/z	
			1	2
DMP	(dimethyl phthalate)	163	77	194
DMP-d4		167	81	198
DEP	(diethyl phthalate)	149	177	222
DEP-d4		153	181	226
DiBP	(di-isobutyl phthalate)	149	167	223
DiBP-d4		153	171	227
DnBP	(dibutyl phthalate)	149	205	223
DnBP-d4		153	209	227
BBP	(butyl benzyl phthalate)	149	91	206
BBP-d4		153	95	210
DCHP	(dicyclohexyl phthalate)	149	167	249
DCHP-d4		153	171	253
DEHP	(bis(2-ethylhexyl) phthalate)	149	167	279
DEHP-d4		153	171	283
DnOP	(dioctyl phthalate)	149	167	279
DnOP-d4		153	171	283
DINP	(di-isononyl phthalate)	149	293	
DIDP	(di-isodecyl phthalate)	149	307	

COMPENDIUM OF INTERNATIONAL METHODS OF ANALYSIS - OIV
Method of determination of phthalates
by gas chromatography / mass spectrometry in wines

Table 2

		Quantifying transition	Qualifying transition
DMP	(dimethyl phthalate)	194>163	194>77
DMP-d4		198>167	198>81
DEP	(diethyl phthalate)	177>149	177>93
DEP-d4		181>153	181>97
DiBP	(di-isobutyl phthalate)	223>149	205>149
DiBP-d4		227>153	209>153
DnBP	(dibutyl phthalate)	223>149	205>149
DnBP-d4		227>153	209>153
BBP	(butyl benzyl phthalate)	206>149	149>121
BBP-d4		210>153	153>125
DCHP	(dicyclohexyl phthalate)	249>149	249>93
DCHP-d4		253>153	253>97
DEHP	(bis(2-ethylhexyl) phthalate)	279>149	279>93
DEHP-d4		283>153	283>97
DnOP	(dioctyl phthalate)	279>149	279>93
DnOP-d4		283>153	283>93
DINP	(di-isononyl phthalate)	293>149	
DIDP	(di-isodecyl phthalate)	307>149	

APPENDIX II
(for information)

GC/MS chromatograms of a phthalate standard solution and deuterated internal standards.

COMPENDIUM OF INTERNATIONAL METHODS OF ANALYSIS - OIV
Method of determination of phthalates
by gas chromatography / mass spectrometry in wines

APPENDIX III
(for information)

VALIDATION OF ANALYSIS OF PHTHALATES IN WINES

1. Executive Summary

The Institute for Reference Materials and Measurements (IRMM) organised in close collaboration with the International Organisation of Vine and Wine (OIV) this collaborative study to validate *Compendium* method OIV-MA-AS323-10:2013 for the determination of ten phthalates in wine by gas chromatography - mass spectrometry (GC-MS).

The design of the method performance study complied with provisions given in ISO 5725-2 and those established by the OIV. The test samples consisted of red wine, white wine, and sweet wine presented as blind duplicates (see Table 1).

The wines were spiked at IRMM, bottled into ampoules, and dispatched to the participants of the validation study.

In addition to the test samples, participants received a deuterated phthalate solution, in order to be able to prepare the internal standard solutions.

The participants of the study were identified by the OIV following a pre-validation study for the method. They comprised laboratories from Europe, Asia, South America and Australia (see Table 2).

The evaluation of the reported results was performed according to ISO 5725-2 and ISO 5725-4, as well as the provisions established by the OIV. Relative standard deviations for reproducibility were mostly within the range of 9% to 71%.

Table 1

Sample	S001	S002	S003	S004	S005	S006
Nature	White wine		Red wine		Sweet wine	

2. Participants in the study

Table 2: Participants in the study

COMPENDIUM OF INTERNATIONAL METHODS OF ANALYSIS - OIV
Method of determination of phthalates
by gas chromatography / mass spectrometry in wines

Analab Chile S.A.	Chile
Animal & Plant & Food Inspection Centre, Tianjin Exit- Entry Inspection and Quarantine Bureau	People's Republic of China
Bureau Interprofessionnel du Cognac	France
Central National de Verificare a Calitatii Productiei Alcoolice	Republic of Moldova
Chemisches und Veterinaeruntersuchungsamt Stuttgart	Germany
Escola Superior de Biotecnologia Universidade Católica Portuguesa	Portugal
Instituto Nacional de Vitivinicultura Departamento de Normas Analiticas Especiales	Argentina
Laboratorio Arbitral Agroalimentario	Spain
Laboratoire DUBERNET	France
Miguel Torres S.A.	Spain
SAILab	Spain
SCL Laboratoire de Bordeaux	France
SCL Laboratoire de Montpellier	France
The Australian Wine Research Institute	Australia

3. Evaluation of submitted results

The fitness-for-purpose of the calculated reproducibility standard deviation was evaluated. For this purpose, the calculated reproducibility relative standard deviation (RSD_R) was compared to the relative standard deviation derived from the

COMPENDIUM OF INTERNATIONAL METHODS OF ANALYSIS - OIV
Method of determination of phthalates
by gas chromatography / mass spectrometry in wines

modified Horwitz equation (RSD_{mH}), as proposed by Thompson (Thompson 2000). The latter provides a concentration dependant guidance level for reproducibility. The agreement with the guidance level of precision was expressed as HORRAT values for reproducibility ($HORRAT_R$).

4. Evaluation of systematic effects

Laboratories reporting results that, for one or more analytes, exceeded the 1% threshold level of either the Mandel's h or Mandel's k tests were contacted by the organisers and requested to check their reported data and to confirm them if appropriate. Results were excluded from data evaluations if the laboratory did not confirm the correctness of the reported analytical results.

5. Evaluation of reported results by analyte

Based on the results of the separate analysis of each analyte and according to the reproducibility results, the method should be considered as either type II (DCHP BBP DBP DIBP DEP) or type IV (DIDP DINP DNOP DEHP DMP).

COMPENDIUM OF INTERNATIONAL METHODS OF ANALYSIS - OIV
Method of determination of phthalates
by gas chromatography / mass spectrometry in wines

Table 3: Dimethyl phthalate (DMP)¹ – Results of data evaluation

		S001	S002	S003	S004	S005	S006
No. of laboratories that submitted compliant results		11	10	11	10	10	11
Mean	mg/l	0.020	0.073	0.018	0.031	0.053	0.027
Median	mg/l	0.020	0.060	0.018	0.030	0.056	0.028
Assigned value	mg/l	0.030	0.097	0.030	0.049	0.104	0.046
Rel. dev. assign. value		-33.3%	-38.1%	-40.0%	-38.8%	-46.2%	-39.1%
Repeatability s.d.	mg/l	0.003	0.007	0.002	0.006	0.011	0.003
Reproducibility s.d.	mg/l	0.006	0.041	0.007	0.011	0.022	0.009
Rel. repeatability s.d.		9.42%	7.33%	8.04%	13.00%	10.25%	7.09%
Rel. reproducibility s.d.		20.10%	42.40%	23.12%	22.54%	21.10%	19.07%
Modified Horwitz s.d. **		22.00%	22.00%	22.00%	22.00%	22.00%	22.00%
HORRATR		0.91	1.93	1.05	1.02	0.96	0.87
Limit of repeatability, r (2.77 X sr)	mg/l	0.008	0.020	0.007	0.018	0.030	0.009
Limit of reproducibility, R (2.77 X sR)	mg/l	0.017	0.114	0.019	0.031	0.061	0.024
Rel. limit of repeatability		26.09%	20.32%	22.28%	36.00%	28.38%	19.64%
Rel. limit of reproducibility		55.67%	117.45%	64.05%	62.44%	58.45%	52.84%
No. of laboratories after elimination of outliers		9	9	8	8	9	10
No. of measurement values without outliers		18	18	15	16	18	20

Table 4: Diethyl phthalate (DEP)² – Results of data evaluation

¹ Type IV method

² Type II method

COMPENDIUM OF INTERNATIONAL METHODS OF ANALYSIS - OIV
Method of determination of phthalates
by gas chromatography / mass spectrometry in wines

		S001	S002	S003	S004	S005	S006
No. of laboratories that submitted compliant results		12	11	11	11	10	12
Mean	mg/l	0.048	0.065	0.030	0.039	0.021	0.059
Median	mg/l	0.044	0.076	0.029	0.041	0.023	0.061
Assigned value	mg/l	0.057	0.092	0.031	0.056	0.030	0.089
Rel. dev. assign. value		-22.8%	-17.4%	-6.5%	-26.8%	-23.3%	-31.5%
Repeatability s.d.	mg/l	0.006	0.010	0.005	0.004	0.003	0.002
Reproducibility s.d.	mg/l	0.026	0.026	0.015	0.017	0.008	0.019
Rel. repeatability s.d.		10.49%	11.32%	15.28%	7.00%	11.41%	2.53%
Rel. reproducibility s.d.		45.36%	28.49%	47.95%	29.71%	25.74%	20.98%
Modified Horwitz s.d. **		22.00%	22.00%	22.00%	22.00%	22.00%	22.00%
HORRATR		2.06	1.30	2.18	1.35	1.17	0.95
Limit of repeatability, r (2.77 X sr)	mg/l	0.017	0.029	0.013	0.011	0.009	0.006
Limit of reproducibility, R (2.77 X sR)	mg/l	0.072	0.073	0.041	0.046	0.021	0.052
Rel. limit of repeatability		29.05%	31.35%	42.32%	19.40%	31.60%	7.01%
Rel. limit of reproducibility		125.66%	78.91%	132.81%	82.29%	71.30%	58.12%
No. of laboratories after elimination of outliers		11	10	11	9	10	11
No. of measurement values without outliers		21	20	21	17	20	22

Table 5: Diisobutyl phthalate (DIBP)³ – Results of data evaluation

³ Type II method

COMPENDIUM OF INTERNATIONAL METHODS OF ANALYSIS - OIV
Method of determination of phthalates
by gas chromatography / mass spectrometry in wines

		S001	S002	S003	S004	S005	S006
No. of laboratories that submitted compliant results		11	10	11	10	10	11
Mean	mg/l	0.049	0.087	0.076	0.119	0.054	0.046
Median	mg/l	0.049	0.085	0.076	0.123	0.055	0.045
Assigned value	mg/l	0.035	0.076	0.058	0.107	0.061	0.045
Rel. dev. assign. value		40.0%	11.8%	31.0%	15.0%	-9.8%	0.0%
Repeatability s.d.	mg/l	0.003	0.006	0.007	0.009	0.002	0.004
Reproducibility s.d.	mg/l	0.011	0.019	0.014	0.023	0.012	0.013
Rel. repeatability s.d.		7.43%	7.71%	11.55%	8.81%	4.04%	9.54%
Rel. reproducibility s.d.		32.18%	25.23%	24.48%	21.95%	19.98%	28.37%
Modified Horwitz s.d. **		22.00%	22.00%	22.00%	22.00%	22.00%	22.00%
HORRATR		1.46	1.15	1.11	1.00	0.91	1.29
Limit of repeatability, r (2.77 X sr)	mg/l	0.007	0.016	0.019	0.026	0.007	0.012
Limit of reproducibility, R (2.77 X sR)	mg/l	0.031	0.053	0.039	0.065	0.034	0.035
Rel. limit of repeatability		20.58%	21.35%	31.98%	24.42%	11.19%	26.44%
Rel. limit of reproducibility		89.15%	69.88%	67.80%	60.81%	55.35%	78.58%
No. of laboratories after elimination of outliers		11	10	11	10	10	11
No. of measurement values without outliers		21	20	21	20	20	22

COMPENDIUM OF INTERNATIONAL METHODS OF ANALYSIS - OIV
Method of determination of phthalates
by gas chromatography / mass spectrometry in wines

Table 6: Dibutyl phthalate (DBP)⁴ – Results of data evaluation

		S001	S002	S003	S004	S005	S006
No. of laboratories that submitted compliant results		12	11	12	11	11	12
Mean	mg/l	0.103	0.264	0.078	0.728	0.090	0.178
Median	mg/l	0.103	0.266	0.074	0.666	0.089	0.174
Assigned value	mg/l	0.107	0.281	0.057	1.039	0.032	0.153
Rel. dev. assign. value		-3.7%	-5.3%	29.8%	-35.9%		
Repeatability s.d.	mg/l	0.009	0.014	0.011	0.033	0.004	0.012
Reproducibility s.d.	mg/l	0.022	0.048	0.021	0.314	0.018	0.022
Rel. repeatability s.d.		8.24%	5.03%	19.11%	3.21%	13.79%	7.87%
Rel. reproducibility s.d.		20.73%	17.01%	36.78%	30.25%	57.05%	14.66%
Modified Horwitz s.d. **		22.00%	19.36%	22.00%	15.91%	22.00%	21.22%
HORRATR		0.94	0.88	1.67	1.90	2.59	0.69
Limit of repeatability, r (2.77 X sr)	mg/l	0.024	0.039	0.030	0.092	0.012	0.033
Limit of reproducibility, R (2.77 X sR)	mg/l	0.061	0.132	0.058	0.871	0.051	0.062
Rel. limit of repeatability		22.81%	13.92%	52.94%	8.89%	38.21%	21.80%
Rel. limit of reproducibility		57.43%	47.12%	101.88%	83.79%	158.03%	40.60%
No. of laboratories after elimination of outliers		12	11	12	10	11	11
No. of measurement values without outliers		23	22	23	20	22	22

⁴ Type II method

COMPENDIUM OF INTERNATIONAL METHODS OF ANALYSIS - OIV
Method of determination of phthalates
by gas chromatography / mass spectrometry in wines

Table 7: Benzyl butyl phthalate (BBP)⁵ – Results of data evaluation

		S001	S002	S003	S004	S005	S006
No. of laboratories that submitted compliant results		11	10	11	10	10	11
Mean	mg/l	0.049	0.026	0.033	0.074	0.075	0.050
Median	mg/l	0.050	0.027	0.034	0.075	0.078	0.051
Assigned value	mg/l	0.057	0.029	0.037	0.088	0.087	0.053
Rel. dev. assign. value		-12.3%	-6.9%	-8.1%	-14.8%	-10.3%	-3.8%
Repeatability s.d.	mg/l	0.002	0.001	0.003	0.004	0.003	0.003
Reproducibility s.d.	mg/l	0.008	0.004	0.005	0.011	0.015	0.007
Rel. repeatability s.d.		4.30%	4.96%	8.08%	5.10%	3.31%	4.78%
Rel. reproducibility s.d.		13.71%	13.82%	13.93%	12.72%	17.00%	14.00%
Modified Horwitz s.d. **		22.00%	22.00%	22.00%	22.00%	22.00%	22.00%
HORRATR		0.62	0.63	0.63	0.58	0.77	0.64
Limit of repeatability, r (2.77 X sr)	mg/l	0.007	0.004	0.008	0.012	0.008	0.007
Limit of reproducibility, R (2.77 X sR)	mg/l	0.022	0.011	0.014	0.031	0.041	0.021
Rel. limit of repeatability		11.90%	13.75%	22.38%	14.14%	9.16%	13.23%
Rel. limit of reproducibility		37.98%	38.27%	38.58%	35.23%	47.09%	38.77%
No. of laboratories after elimination of outliers		9	8	10	9	9	10
No. of measurement values without outliers		17	15	19	18	18	20

⁵ Type II method

COMPENDIUM OF INTERNATIONAL METHODS OF ANALYSIS - OIV
Method of determination of phthalates
by gas chromatography / mass spectrometry in wines

Table 8: Dicyclohexyl phthalate (DCHP)⁶ – Results of data evaluation

		S001	S002	S003	S004	S005	S006
No. of laboratories that submitted compliant results		9	8	9	8	8	9
Mean	mg/l	0.079	0.042	0.030	0.088	0.046	0.031
Median	mg/l	0.076	0.044	0.033	0.091	0.050	0.033
Assigned value	mg/l	0.084	0.048	0.038	0.105	0.057	0.036
Rel. dev. assign. value		-9.5%	-8.3%	-13.2%	-13.3%	-12.3%	-8.3%
Repeatability s.d.	mg/l	0.005	0.006	0.003	0.005	0.002	0.001
Reproducibility s.d.	mg/l	0.024	0.008	0.005	0.011	0.011	0.006
Rel. repeatability s.d.		5.60%	13.13%	6.75%	4.84%	3.25%	3.67%
Rel. reproducibility s.d.		28.46%	16.05%	12.93%	10.20%	18.83%	16.37%
Modified Horwitz s.d. **		22.00%	22.00%	22.00%	22.00%	22.00%	22.00%
HORRATR		1.29	0.73	0.59	0.46	0.86	0.74
Limit of repeatability, r (2.77 X sr)	mg/l	0.013	0.017	0.007	0.014	0.005	0.004
Limit of reproducibility, R (2.77 X sR)	mg/l	0.066	0.021	0.014	0.030	0.030	0.016
Rel. limit of repeatability		15.53%	36.37%	18.69%	13.40%	9.00%	10.18%
Rel. limit of reproducibility		78.83%	44.46%	35.82%	28.24%	52.15%	45.35%
No. of laboratories after elimination of outliers		9	7	8	7	7	8
No. of measurement values without outliers		18	14	15	14	14	16

⁶ Type II method

COMPENDIUM OF INTERNATIONAL METHODS OF ANALYSIS - OIV
Method of determination of phthalates
by gas chromatography / mass spectrometry in wines

Table 9: Bis (2-ethylhexyl) phthalate (DEHP)⁷ – Results of data evaluation

		S001	S002	S003	S004	S005	S006
No. of laboratories that submitted compliant results		12	11	12	11	11	12
Mean	mg/l	0.101	0.028	0.602	0.150	0.741	1.032
Median	mg/l	0.099	0.026	0.654	0.180	0.709	1.115
Assigned value	mg/l	0.217	0.046	1.049	0.328	1.569	2.013
Rel. dev. assign. value		-54.4%	-43.5%	-37.7%	-45.1%	-54.8%	-44.6%
Repeatability s.d.	mg/l	0.017	0.005	0.206	0.016	0.122	0.266
Reproducibility s.d.	mg/l	0.019	0.011	0.238	0.063	0.465	0.563
Rel. repeatability s.d.		7.72%	11.54%	19.66%	4.82%	7.78%	13.20%
Rel. reproducibility s.d.		8.92%	24.15%	22.70%	19.11%	29.61%	27.96%
Modified Horwitz s.d. **		20.13%	22.00%	15.88%	18.92%	14.95%	14.40%
HORRATR		0.44	1.10	1.43	1.01	1.98	1.94
Limit of repeatability, r (2.77 X sr)	mg/l	0.046	0.015	0.571	0.044	0.338	0.736
Limit of reproducibility, R (2.77 X sR)	mg/l	0.054	0.031	0.660	0.174	1.287	1.559
Rel. limit of repeatability		21.39%	31.98%	54.45%	13.36%	21.54%	36.55%
Rel. limit of reproducibility		24.70%	66.91%	62.87%	52.93%	82.03%	77.46%
No. of laboratories after elimination of outliers		10	10	12	9	11	12
No. of measurement values without outliers		20	20	23	18	22	24

⁷ Type IV method

COMPENDIUM OF INTERNATIONAL METHODS OF ANALYSIS - OIV
Method of determination of phthalates
by gas chromatography / mass spectrometry in wines

Table 10: Di-n-octyl phthalate (DNOP)⁸ – Results of data evaluation

		S001	S002	S003	S004	S005	S006
No. of laboratories that submitted compliant results		11	10	11	10	9	10
Mean	mg/l	0.031	0.015	0.051	0.073	0.016	0.026
Median	mg/l	0.035	0.015	0.049	0.061	0.019	0.028
Assigned value	mg/l	0.086	0.031	0.059	0.114	0.036	0.054
Rel. dev. assign. value		-59.3%	-51.6%	-16.9%	-46.5%	-47.2%	-48.1%
Repeatability s.d.	mg/l	0.007	0.003	0.021	0.005	0.004	0.005
Reproducibility s.d.	mg/l	0.010	0.003	0.023	0.038	0.008	0.011
Rel. repeatability s.d.		7.84%	9.25%	36.33%	4.51%	11.18%	9.23%
Rel. reproducibility s.d.		11.50%	9.33%	38.90%	33.40%	23.32%	20.10%
Modified Horwitz s.d. **		22.00%	22.00%	22.00%	22.00%	22.00%	22.00%
HORRATR		0.52	0.42	1.77	1.52	1.06	0.91
Limit of repeatability, r (2.77 X sr)	mg/l	0.019	0.008	0.059	0.014	0.011	0.014
Limit of reproducibility, R (2.77 X sR)	mg/l	0.027	0.008	0.064	0.105	0.023	0.030
Rel. limit of repeatability		21.73%	25.61%	100.62%	12.50%	30.97%	25.56%
Rel. limit of reproducibility		31.85%	25.85%	107.76%	92.52%	64.60%	55.66%
No. of laboratories after elimination of outliers		9	8	10	9	7	8
No. of measurement values without outliers		18	15	18	16	14	16

⁸ Type IV method

COMPENDIUM OF INTERNATIONAL METHODS OF ANALYSIS - OIV
Method of determination of phthalates
by gas chromatography / mass spectrometry in wines

Table 11: Diisononyl phthalate (DINP)⁹ – Results of data evaluation

		S001	S002	S003	S004	S005	S006
No. of laboratories that submitted compliant results		9	8	10	8	8	9
Mean	mg/l	0.027	0.108	1.820	0.059	0.115	0.064
Median	mg/l	0.028	0.116	1.497	0.058	0.136	0.051
Assigned value	mg/l	0.054	0.242	3.134	0.104	0.271	0.057
Rel. dev. assign. value		-48.1%	-52.1%	-52.2%	-44.2%	-49.8%	-10.5%
Repeatability s.d.	mg/l	0.004	0.019	0.520	0.005	0.010	0.003
Reproducibility s.d.	mg/l	0.006	0.027	1.067	0.019	0.072	0.040
Rel. repeatability s.d.		8.14%	7.84%	16.60%	5.17%	3.83%	5.51%
Rel. reproducibility s.d.		10.27%	11.18%	34.06%	18.41%	26.60%	70.59%
Modified Horwitz s.d. **		20.00%	20.00%	20.00%	20.00%	20.00%	20.00%
HORRATR		0.51	0.56	1.70	0.92	1.33	3.53
Limit of repeatability, r (2.77 X sr)	mg/l	0.012	0.053	1.441	0.015	0.029	0.009
Limit of reproducibility, R (2.77 X sR)	mg/l	0.015	0.075	2.957	0.053	0.200	0.111
Rel. limit of repeatability		22.55%	21.71%	45.99%	14.32%	10.61%	15.27%
Rel. limit of reproducibility		28.44%	30.98%	94.35%	50.99%	73.69%	195.53%
No. of laboratories after elimination of outliers		5	6	9	7	6	6
No. of measurement values without outliers		10	11	17	13	12	12

⁹ Type IV method

COMPENDIUM OF INTERNATIONAL METHODS OF ANALYSIS - OIV
Method of determination of phthalates
by gas chromatography / mass spectrometry in wines

Table 12: Diisodecyl phthalate (DIDP)¹⁰ – Results of data evaluation

		S001	S002	S003	S004	S005	S006
No. of laboratories that submitted compliant results		8	7	8	7	7	8
Mean	mg/l	0.096	0.103	0.677	0.152	0.186	1.828
Median	mg/l	0.102	0.107	0.540	0.152	0.181	1.660
Assigned value	mg/l	0.275	0.186	0.200	0.281	0.427	3.070
Rel. dev. assign. value		-62.9%	-42.5%	170.0%	-45.9%	-57.6%	-45.9%
Repeatability s.d.	mg/l	0.009	0.018	0.477	0.048	0.027	0.202
Reproducibility s.d.	mg/l	0.025	0.018	0.505	0.058	0.109	1.676
Rel. repeatability s.d.		3.42%	9.61%	238.49%	17.11%	6.27%	6.57%
Rel. reproducibility s.d.		9.11%	9.61%	252.34%	20.51%	25.43%	54.59%
Modified Horwitz s.d. **		20.00%	20.00%	20.38%	20.00%	20.00%	20.00%
HORRATR		0.46	0.48	12.38	1.03	1.27	2.73
Limit of repeatability, r (2.77 X sr)	mg/l	0.026	0.050	1.321	0.133	0.074	0.559
Limit of reproducibility, R (2.77 X sR)	mg/l	0.069	0.050	1.398	0.160	0.301	4.642
Rel. limit of repeatability		9.46%	26.62%	660.61%	47.40%	17.37%	18.21%
Rel. limit of reproducibility		25.25%	26.62%	698.98%	56.82%	70.44%	151.21%
No. of laboratories after elimination of outliers		7	5	7	7	7	7
No. of measurement values without outliers		14	10	13	14	14	14

6. References

¹⁰ Type IV method

COMPENDIUM OF INTERNATIONAL METHODS OF ANALYSIS - OIV
Method of determination of phthalates
by gas chromatography / mass spectrometry in wines

Report on the Method Performance Study of a Method to Determine Phthalates in Wine Determination of Ten Phthalates in Wine by Gas Chromatography Mass Spectrometry (GC-MS), Wenzl Thomas, Karasek Lubomir, Giri Anupam.
Publications Office of the European Union 2015 doi :10.2787/666948 (online)
<https://publications.europa.eu/en/publication-detail/-/publication/b3ebef67-fldb-4fb2-97ce-bfc301c8ce68/language-en>

COMPENDIUM OF INTERNATIONAL METHODS OF ANALYSIS-OIV
Method for the determination of potassium polyaspartate in wine by
high-performance liquid chromatography coupled
with a fluorescence detector

Method OIV-MA-AS323-11

Type IV methods

Method for the determination of potassium polyaspartate in
wine by high-performance liquid chromatography coupled
with a fluorescence detector

OIV-OENO 619-2019

1. SCOPE OF APPLICATION

This method is applicable to the analysis of potassium polyaspartate (KPA) in wines at concentrations higher than 40 mg/L.

2. PRINCIPLE

The procedure consists of carrying out the determination of aspartic acid in wine before and after acid hydrolysis, by derivatisation with ortho-phthalaldehyde (OPA) followed by chromatographic analysis coupled with a fluorescence detector. The difference in the aspartic acid content between the hydrolysed sample and non-hydrolysed sample will indicate the level of addition of polyaspartate.

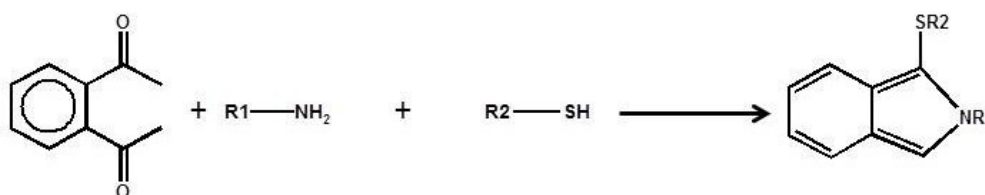

Ortho-phthalaldehyde (OPA)

R1-NH₂: aspartic acid

R2-SH: mercaptoethanol

Derivatised AA

3. REAGENTS AND PRODUCTS

COMPENDIUM OF INTERNATIONAL METHODS OF ANALYSIS-OIV
Method for the determination of potassium polyaspartate in wine by
high-performance liquid chromatography coupled
with a fluorescence detector

Use ultra-pure water (EN ISO 3696 Grade 3 or double-distilled water)

For acid hydrolysis:

- 3.1. 10 g/L Sodium metabisulphite ($\text{Na}_2\text{S}_2\text{O}_5$, CAS No.: 7681-57-4) solution: weigh 5 grams of sodium metabisulphite into a 500-mL Class A flask and make up to the mark with ultra-pure water.
- 3.2. 6 M Hydrochloric acid (HCl, CAS No.: 7647-01-0)
- 3.3. 5 M Sodium hydroxide (NaOH, CAS No.: 1310-73-2)

Standard solutions:

- 3.4. Aspartic acid (DL-aspartic acid $\text{C}_4\text{H}_7\text{NO}_4$, purity $\geq 99\%$, CAS No.: 617-45-8)
 - 3.4.1. Stock solution 1: solution of 8000 mg/L aspartic acid in ultra-pure H_2O
 - 3.4.2. Stock solution 2: solution of 200 mg/L aspartic acid in ultra-pure H_2O
- 3.5. Aminocaproic acid ($\text{C}_6\text{H}_{13}\text{NO}_2$, purity $\geq 99\%$, CAS No.: 60-32-2)
 - 3.5.1. Stock solution of aminocaproic acid at 1000 mg/L in ultra-pure H_2O (internal standard)

Calibration solutions prepared through dilution of stock solutions 1 and 2 in double-distilled H_2O . The reference values are as follows:

- **2 mg/L STD1**: take 0.200 mL of stock solution 2 (3.4.2.) and make up to the mark in a 20-mL flask with ultra-pure H_2O
- **10 mg/L STD2**: take 1.000 mL of stock solution 2 (3.4.2.) and make up to the mark in a 20-mL flask with ultra-pure H_2O
- **50 mg/L STD3**: take 5.000 mL of stock solution 2 (3.4.2.) and make up to the mark in a 20-mL flask with ultra-pure H_2O
- **100 mg/L STD4**: take 0.250 mL of stock solution 1 (3.4.1.) and make up to the mark in a 20-mL flask with ultra-pure H_2O
- **250 mg/L STD5**: take 0.625 mL of stock solution 1 (3.4.1.) and make up to the mark in a 20-mL flask with ultra-pure H_2O
- **500 mg/L STD6**: take 1.250 mL of stock solution 1 (3.4.1.) and make up to the mark in a 20-mL flask with ultra-pure H_2O

Derivatising solution:

- 3.6. Sodium tetraborate decahydrate (solid, purity $> 99\%$, CAS No. 1303-96-4)
 - 3.6.1. 0.1 M Sodium tetraborate decahydrate buffer solution with a pH of 10.5: dissolve 19.1 g sodium tetraborate and make up to the mark in a 500-mL flask with ultra-pure water. Check the pH value.
- 3.7. Ortho-phthalaldehyde (OPA) ($\text{C}_8\text{H}_6\text{O}_2$, purity $\geq 99\%$, CAS No.: 643-79-8)

COMPENDIUM OF INTERNATIONAL METHODS OF ANALYSIS-OIV
Method for the determination of potassium polyaspartate in wine by
high-performance liquid chromatography coupled
with a fluorescence detector

3.8. Mercaptoethanol (C₂H₆OS, purity ≥ 99%, CAS No.: 60-24-2)

3.9. Derivatising solution: add 100 mg OPA, 200 µL mercaptoethanol and 1 mL methanol to a 10 mL-flask and make up to the mark with the 0.1 M sodium tetraborate decahydrate buffer solution with a pH of 10.5. The solution should be prepared just before use.

Mobile phases for HPLC:

3.10. HPLC-grade methanol (liquid)

3.11. HPLC-grade tetrahydrofuran (liquid)

3.12. Anhydrous sodium acetate (CAS No.: 127-09-3)

3.12.1. 0.05 M Sodium acetate buffer solution: dissolve 2.05 g anhydrous sodium acetate and make up to the mark in a calibrated 500-mL flask with ultra-pure water.

3.13. HPLC-grade acetonitrile (CH₃CN) (liquid)

3.14. Ultra-pure water (e.g. EN ISO 3696 Grade 3 or double-distilled water)

3.15. Mobile phase:

- [eluent A]: ultra-pure water,
- [eluent B]: 0.05 M sodium acetate / tetrahydrofuran (96:4) buffer solution,
- [eluent C]: methanol,
- [eluent D]: acetonitrile.

4. EQUIPMENT AND APPARATUS

Unless otherwise specified, the glassware required to prepare the solutions should be class A.

4.1. Hot plate

4.2. 4-mL Tinted-glass vial with screw cap

4.3. 0.100-1.000-mL Micropipette

4.4. Cellulose-acetate-membrane syringe filter with porosity of 0.20 µm

4.5. Precision balance

4.6. Calibrated flasks

4.7. HPLC system that includes a quaternary pump, automatic sampler, compartment with thermostat for the column and FLD

4.8. Column: polar endcapped C18 (e.g. Synchronis aQ 4.6 x 250 mm; 5 µm)

5. PROCEDURE

The procedure is divided into three phases: hot acid hydrolysis of the wine sample; the process of preparation of the samples (both of the calibration solutions and of the wines before and after hydrolysis), which are analysed by HPLC-FLD to determine the aspartic acid concentration; and HPLC-FLD analysis.

COMPENDIUM OF INTERNATIONAL METHODS OF ANALYSIS-OIV
Method for the determination of potassium polyaspartate in wine by
high-performance liquid chromatography coupled
with a fluorescence detector

Phase 1: Acid hydrolysis

- Pour the following successively into a 4-mL tinted-glass vial with screw cap (4.2.):
- 0.2 mL solution of 10 g/L sodium metabisulphite (3.1.),
- 2 mL wine sample,
- 2 mL 6 M HCl (3.2.);
- heat to 108 °C (± 2 °C) on a hot plate for 72 hours;
- pour into a 10-mL flask, add 2.5 mL 5 M NaOH (3.3.) and make up to the mark with ultra-pure water.

The verification of the acid hydrolysis process is detailed in paragraph 6.

Phase 2: Preparation for HPLC analysis

The method envisages a derivatisation reaction of aspartic acid with ortho-phthalaldehyde (OPA).

To prepare the samples for analysis by HPLC, proceed as follows:

Calibration solutions and wine samples before hydrolysis:

- take a 1 mL sample of the solution for analysis and micro-filter (0.20 μm filter) it into a 20-mL flask,
- add 0.2 mL internal standard (3.5.1.),
- make up to the mark with ultra-pure water.

Samples after hydrolysis:

- take a 5 mL sample of the solution for analysis and micro-filter (0.20 μm filter) it into a 20-mL flask,
- add 0.2 mL internal standard (3.5.1.),
- make up to the mark with ultra-pure water.

Phase 3: HPLC analysis

The instrumental parameters for analysis by HPLC-FLD, for example, are as follows:

Oven temperature: 40 °C

Injection: 10 μL

FLD Wavelength (λ): $\lambda_{\text{ex}} = 340$ nm; $\lambda_{\text{em}} = 450$ nm

The separation is conducted in gradient mode (see the eluents in point 3.15.):

COMPENDIUM OF INTERNATIONAL METHODS OF ANALYSIS-OIV
Method for the determination of potassium polyaspartate in wine by
high-performance liquid chromatography coupled
with a fluorescence detector

Time	%B	%C	%D	Flow
0.00	100.0	0.0	0.0	1.1
3.00	100.0	0.0	0.0	1.1
15.00	50.0	25.0	25.0	1.1
17.00	84.0	8.0	8.0	1.1
18.00	100.0	0.0	0.0	1.1
Stop time: 21 min + 2 min post time				

The following is an example of the automated derivatisation mode with an autosampler:

- Reagent positions in the autosampler:
 - position 1: methanol,
 - position 3: OPA,
 - position 4: empty vial,
 - position 11: ultra-pure water.

- Derivatisation phases:
 - draw 2.0 µL from the air,
 - draw 20.0 µL from vial 1,
 - transfer 20.0 µL into vial 4,
 - draw 5.0 µL from the sample,
 - transfer 5.0 µL into seat,
 - draw 0.0 µL from vial 1 (to clean the outside of the needle),
 - draw 5.0 µL from vial 3,
 - transfer 5.0 µL into seat,
 - mix 10.0 µL in seat, 10 times,
 - wait 0.50 min,
 - inject.

If the results obtained are higher than the calibration curve limit, dilute the sample as appropriate and perform the test again.

COMPENDIUM OF INTERNATIONAL METHODS OF ANALYSIS-OIV
Method for the determination of potassium polyaspartate in wine by
high-performance liquid chromatography coupled
with a fluorescence detector

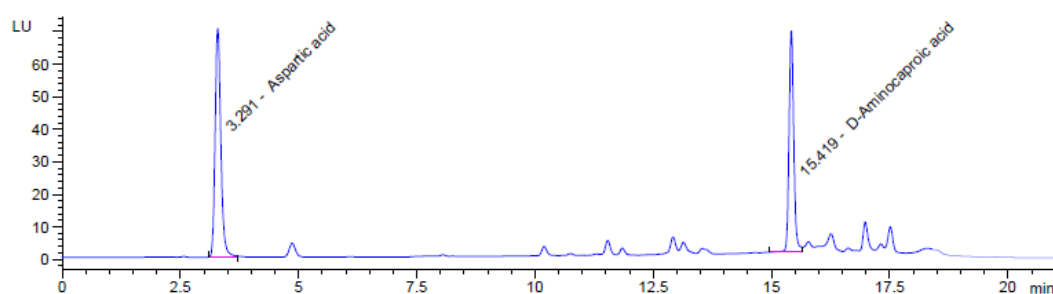

Chromatogram derived from a red wine

6. QUALITY CONTROL

For each series of analyses, quality control should be carried out through analysis of a wine sample to which 100 mg/L aspartic acid is added.

The sample, prepared according to point 5, is analysed at the beginning of the series. The results obtained, given in terms of the percentage yield, are recorded on a control chart.

7. METHOD CHARACTERISTICS: INTRA-LABORATORY VALIDATION PARAMETERS

- Linearity

Non-hydrolysed, non-derivatised calibration solutions of known concentration are used to simulate the entire analytical process. Each sequence, to be acceptable, should contain calibration curves with an $R^2 > 0.990$ (Figure 1).

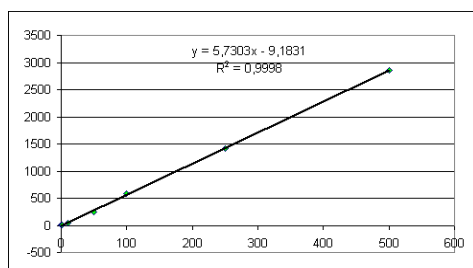

Figure 1

- Recovery and matrix effect

Aqueous solutions:

The recovery rate for the processes of acid hydrolysis and derivatisation is verified through comparison of the pre-hydrolysis and post-hydrolysis aqueous stock solutions of aspartic acid. Three solutions of known concentration (25, 100 and 200 mg/L) were prepared; the data obtained is shown in the following table:

COMPENDIUM OF INTERNATIONAL METHODS OF ANALYSIS-OIV
Method for the determination of potassium polyaspartate in wine by
high-performance liquid chromatography coupled
with a fluorescence detector

	Test 1	Test 2	Test 3
Before hydrolysis (mg/L)	25.4	109	213
After hydrolysis (mg/L)	25.2	108	213
Recovery rate (%)	99.2	99.1	100

Wine:

The method of standard additions to white wine and red wine was applied (50 mg/L and 200 mg/L potassium polyaspartate gradual additions to verify matrix interference in the determination of KPA). For each level, 5 repeatability tests were carried out.

	Red wine w/o addition (mg/L)	Red wine + 50 mg/L	Red wine + 200 mg/L	White wine w/o addition (mg/L)	White wine + 50 mg/L	White wine + 200 mg/L
Repetitions (in Asp. Ac.)	84.0	123.9	258.2	121.9	164.6	294.2
	85.4	127.3	259.4	123.2	163.3	291.5
	83.8	125.1	250.2	121.9	170.3	291.3
	87.7	124.4	253.5	119.5	161.9	284.8
	83.2	126.1	256.9	123.3	160.0	287.4
Mean (in Asp. Ac.)	84.8	125.4	255.6	122.0	164.0	289.8
S_r (in Asp. Ac.)	1.8	1.4	3.8	1.5	3.9	3.7
Mean (in added KPA)	-	46.6	196.3	-	48.3	193.0
S_r (in added KPA)	-	2.8	5.0	-	4.9	3.8
Horrat r	-	0.99	0.52	-	1.71	0.48
Theoretical KPA	-	50	200	-	50	200
Rec KPA %	-	93	98	-	94	96

COMPENDIUM OF INTERNATIONAL METHODS OF ANALYSIS-OIV
Method for the determination of potassium polyaspartate in wine by
high-performance liquid chromatography coupled
with a fluorescence detector

- S_r (in Asp. Ac.): standard deviation of repeatability tests expressed in aspartic acid
- S_r (in KPA): standard deviation of repeatability tests expressed in KPA
- Rec KPA %: recovery expressed in KPA

The recovery should be within the range of 80-110%.
 The repeatability meets the Horrat criterion.

Limits of detection and quantification:

Considering that the wine naturally contains aspartic acid, the decision was made to determine the LoD and LoQ based on the signal-to-noise ratio determined for the wine samples.

<i>CALCULATION OF THE LIMITS OF DETECTION AND QUANTIFICATION</i>		
CASE N°3: THE SIGNAL-TO-NOISE (S/N) RATIO IS KNOWN FOR A LOW CONCENTRATION		
C	24.74	Value of the wine sample concentration
S/N	122.5	Signal-to-noise ratio
LoD	0.7	Limit of detection
LoQ	2.1	Limit of quantification (3 x LoD)

8. CALCULATION AND EXPRESSION OF RESULTS

The aspartic acid concentration in milligrams per litre (mg/L) present in the samples is calculated through the acquisition programme's processor.

The quantity of potassium polyaspartate (KPA) added is obtained through the difference between the sample subjected to hydrolysis and the non-hydrolysed sample without addition:

$$KPA(mg/L) = \frac{(AsparticAcid_{hydrolysed_wines} - AsparticAcid_{wines_w/o_addition})}{f_{KPA}}$$

where f_{KPA} is the factor of conversion of potassium polyaspartate into aspartic acid, calculated from the ratio of the molecular mass of the potassium polyaspartate monomer to that of aspartic acid, according to the following equation:

COMPENDIUM OF INTERNATIONAL METHODS OF ANALYSIS-OIV
Method for the determination of potassium polyaspartate in wine by
high-performance liquid chromatography coupled
with a fluorescence detector

$$f_{KPA} = \frac{MM_{KPA_monomer}}{MM_{aspartic_acid}} = 1.15$$

The results are expressed in mg/L to 1 significant figure.

9. BIBLIOGRAPHY

- OIV-MA-AS1-10 (OENO 7/2000)

**COMPENDIUM OF INTERNATIONAL METHODS OF ANALYSIS – OIV
Simultaneous analysis of iron, copper, potassium, calcium and
manganese in wines, using MP/AES (microwave-induced plasma
atomic emission spectrometry)**

Method OIV-MA-AS323-12

Type IV Method

**Simultaneous analysis of iron, copper, potassium, calcium
and manganese in wines, using MP/AES (microwave-induced
plasma atomic emission spectrometry)
(OIV-OENO 637-2021)**

1 Scope of application

This Type IV method, based on nitrogen plasma atomic emission spectrometry, makes it possible to simultaneously determine the following elements in wines.

Copper	0.05-1 mg·L ⁻¹
Iron	1-10 mg·L ⁻¹
Potassium	15-1200 mg·L ⁻¹
Calcium	1-100 mg·L ⁻¹
Manganese	0.25-4 mg·L ⁻¹

Where necessary, it is the responsibility of each laboratory using this method to redefine, and potentially widen, the scope of application via a validation study.

2 References

- ISO 78-2: Chemistry – Layouts for standards.
- ISO 3696: Water for analytical laboratory use.
- Resolution OIV OENO 418-2013.

**COMPENDIUM OF INTERNATIONAL METHODS OF ANALYSIS – OIV
Simultaneous analysis of iron, copper, potassium, calcium and
manganese in wines, using MP/AES (microwave-induced plasma
atomic emission spectrometry)**

3 Principle

Microwave-induced plasma atomic emission spectrometry (MP-AES) is a spectroscopic elemental method of analysis that works on the principle of atomic emission, with optical detection.

The sample, in liquid form, is introduced into a concentric nebuliser where an aerosol of the sample is generated via a double-pass cyclonic spray chamber and then introduced into the centre of the plasma using the plasma torch. The plasma is generated using a wave guide that focuses and maintains the microwave energy around the torch. The sample is thus desolvated, atomised and ionised, resulting in excitation of the atoms and ions, which are then transferred into the monochromator optical system.

The CCD detector enables simultaneous analysis of the background and signal for greater precision of analysis.

This apparatus functions with nitrogen plasma generated from compressed air and thus makes it possible to reduce the operational costs compared with other spectroscopy techniques for elemental analysis (ICP or AA).

4 Reagents and solutions

Unless otherwise specified, only reagents of recognised analytical quality should be used.

**COMPENDIUM OF INTERNATIONAL METHODS OF ANALYSIS – OIV
Simultaneous analysis of iron, copper, potassium, calcium and
manganese in wines, using MP/AES (microwave-induced plasma
atomic emission spectrometry)**

- 4.1 Ultra-pure, demineralised water with resistivity $\geq 18 \text{ M}\Omega$ (ISO standard 3696)
- 4.2 Mono or multi-elementary solution(s) (at 1000 or 10,000 $\text{mg}\cdot\text{L}^{-1}$), for the mineral elements analysed (Ca, Cu, Fe, K and Mn) and for the indium (In) used as an internal control. Use certified solutions when possible.
- 4.3 Internal control (by way of example): prepared mono- or multi-elementary synthetic solutions, and a control wine for which the target values have been obtained under reliable conditions (certified wine, or wine derived from an inter-laboratory comparison programme).
- 4.4 Nitric acid at over 60% (w/w), for trace analysis (CAS No. 7697-37-2)
- 4.5 Ethanol at over 99% purity (v/v) (CAS No. 64-17-5)
- 4.6 Cesium chloride at over 99% purity (w/w) (CAS No. 7647-17-8)

5 Apparatus and equipment

- 5.1 Atomic emission spectrometer coupled with nitrogen microwave plasma (MP-AES)

Note: The MP-AES can be equipped with a loop for transfer of the sample to increase the life cycle of the consumables (nebuliser and plasma torch). This system carries out rinsing with nitric acid at the sample input channels to the spray chamber. This reduces both the quantity of sample introduced into the nebuliser and the wear level of the equipment.

**COMPENDIUM OF INTERNATIONAL METHODS OF ANALYSIS – OIV
Simultaneous analysis of iron, copper, potassium, calcium and
manganese in wines, using MP/AES (microwave-induced plasma
atomic emission spectrometry)**

5.2 Multi-channel micropipettes suitable for taking variable volumes

5.3 Class A volumetric flasks

6 Preparation of the sample

6.1 Example preparation of the calibration range

Quantification is carried out by external calibration using calibration solutions, making it possible to establish 5-point calibration curves.

The calibration solutions are adjusted to 12% v/v ethanol and 0.2% v/v nitric acid.

Example calibration range:

mg·L ⁻¹	S0	S1	S2	S3	S4	S5
Cu	0	0.1	0.25	0.5	0.75	1
Fe	0	1	2.5	5	7.5	10
K	0	400	600	800	1000	1200
Ca	0	10	25	50	75	100
Mn	0	0.5	1	2	3	4

6.2 Inline dilution of the samples

The calibration range as well as the samples to be analysed are diluted in line to a dilution factor of 1:2, using a simple Y-shaped device placed at the output of the peristaltic pump. The sample (channel 1) is diluted using nitric acid solution at 0.2% indium (600 mg·L⁻¹) and cesium chloride (0.3 g·L⁻¹) (channel 2). Indium is used as a control of stability throughout the analytical sequence, therefore its intensity is measured for all the analysed solutions.

This dilution makes it possible to limit the effects of saturation, in particular on potassium. Nitric acid produces a minor mineralisation effect, which, though only partial, facilitates the passage of organic compounds into the plasma.

**COMPENDIUM OF INTERNATIONAL METHODS OF ANALYSIS – OIV
Simultaneous analysis of iron, copper, potassium, calcium and
manganese in wines, using MP/AES (microwave-induced plasma
atomic emission spectrometry)**

Safety precautions – *When handling acids, operators should protect their hands and eyes. Acids must be handled under a suitable hood.*

7 Procedure

The parameters used to achieve the performance described in point 8 are as follows:

7.1 Instrumental parameters

The following description refers to an MP-AES instrument and provides example analytical conditions. Changes may be made by the laboratory as needed.

Instrumental parameter	Specifications
Nebuliser	OneNeb inert concentric
Spray chamber	Double-pass cyclonic
Tubing for the sample	Black-black (average flow rate 0.25 mL/min)
Tubing for the diluent (HNO ₃ at 0.2%)	Black-black (average flow rate 0.25 mL/min)
Outlet tubing	Blue-blue (average flow rate 1 mL/min)
Sampling duration	20 s
Stabilisation duration	15 s
Rinsing duration	15 s
Pump speed	15 rpm
Number of replicates	3
AVS4 valve	Specifications
Pump speed	10 rpm
Sampling time	20 s (speed: rapid)
Commutation time	18 s
Flush time	15 s (speed: rapid)
Stabilisation duration	20 s

**COMPENDIUM OF INTERNATIONAL METHODS OF ANALYSIS – OIV
Simultaneous analysis of iron, copper, potassium, calcium and
manganese in wines, using MP/AES (microwave-induced plasma
atomic emission spectrometry)**

Number of replicates	3
----------------------	---

7.2 Acquisition parameters

	Copper	Calcium	Iron	Potassium	Manganese	Indium
Reading duration	3 seconds					
Visualisation position	0	10	0	20	0	0
Nebulisation flow rate	0.5 mL/min	0.95 mL/min	0.55 mL/min	0.9 mL/min	0.65 mL/min	0.75 mL/min
Air injection rate	Average					High
Background correction	Automatic					
Calibration adjustment	Rational					/
Analysis wavelength	327.395 nm	445.478 nm	371.993 nm	404.414 nm	403.076 nm	325.600 nm

8 Expression of results

The results are expressed in mg.L⁻¹ of element analysed, and the number of decimal places depends on the method performance for the element in question. Therefore, copper and manganese are expressed to 2 decimal places, iron to 1 decimal place, and potassium and calcium to the nearest unit of measurement, in accordance with the measurement uncertainties and limits of quantification of the method.

**COMPENDIUM OF INTERNATIONAL METHODS OF ANALYSIS – OIV
Simultaneous analysis of iron, copper, potassium, calcium and
manganese in wines, using MP/AES (microwave-induced plasma
atomic emission spectrometry)**

9 Annex: Example internal validation

Performance evaluation and validation were carried out according to the practical guide for the validation, quality control, and evaluation of a usual oenological method of analysis (Resolution OIV-OENO 418-2013).

9.1 Data acquisition

A total of 7 reference materials (ERM, doped samples and/or synthetic solutions) distributed across the range covering the scope of application of the methods in terms of concentration were used. These materials were analysed in $n = 5$ series under reproducibility conditions and within the stability time of the material for the parameter considered. For each material and each series, $p = 2$ repetitions were carried out. In the absence of RM, synthetic solutions composed of 12% ethanol and 0.2% nitric acid may be used.

9.2 Precision results

**Copper 327.395 nm
(mg.L⁻¹)**

Precision	Material 1 (rosé wine)	Material 2 (red wine)	Material 3 (rosé wine)	Material 4 (red wine)	Material 5 (sparkling white wine)	Material 6 (white wine)
Target value	0.05	0.15	0.25	0.5	0.75	1.0
Sr	0.0008	0	0.0032	0.0095	0.01	0.05
r	0.002	0	0.00885	0.02656	0.029	0.137
s _r	0.0015	0.00548	0.01500	0.01500	0.025	0.051
%CV (k=2)	6.27	7.11	12.88	6.01	6.66	9.96

**COMPENDIUM OF INTERNATIONAL METHODS OF ANALYSIS – OIV
Simultaneous analysis of iron, copper, potassium, calcium and manganese in wines, using MP/AES (microwave-induced plasma atomic emission spectrometry)**

Where S_r is the repeatability standard deviation, r is the repeatability, S_1 the intermediate precision standard deviation and %CV the wider precision coefficient of variation.

**Iron 371.993 nm
(mg.L⁻¹)**

Precision	Material 1 (synthetic solution)	Material 2 (red wine)	Material 3 (sparkling white wine)	Material 4 (rosé wine)	Material 5 (red wine)	Material 6 (red wine)	Material 7 (white wine)
Target value	1	1.5	2	2.3	5	7.5	10
S_r	0.078	0	0.045	0.032	0.109	0.145	0.212
r	0.217	0	0.125	0.088	0.307	0.406	0.255
s_I	0.106	0.055	0.088	0.122	0.294	0.280	0.415
%CV (k=2)	24.11	6.68	8.63	10.51	11.56	7.19	8.06

**Potassium 404.414 nm
(mg.L⁻¹)**

Precision	Material 1 (synthetic solution)	Material 2 (rosé wine)	Material 3 (sparkling white wine)	Material 4 (white wine)	Material 5 (red wine)	Material 6 (synthetic solution)	Material 7 (red wine)
Target value	15	363	404.5	675	800	1000	1253
S_r	0.4	5.0	2.8	6.0	4.0	5.6	10.8
r	1.2	14.0	7.9	16.8	11.2	15.7	13.0
s_I	1.0	16.0	19.3	33.5	22.7	41.6	37.1
%CV (k=2)	13.94	8.54	8.79	9.08	5.34	7.87	5.45

Calcium 445.478 nm

COMPENDIUM OF INTERNATIONAL METHODS OF ANALYSIS – OIV
Simultaneous analysis of iron, copper, potassium, calcium and manganese in wines, using MP/AES (microwave-induced plasma atomic emission spectrometry)

(mg.L⁻¹)

Precision	Material 1 (synthetic solution)	Material 2 (synthetic solution)	Material 3 (White wine)	Material 4 (sparkling white wine)	Material 5 (red wine)	Material 6 (white wine)	Material 7 (rosé wine)
Target value	0.5	1	6.8	27.5	54	68	100
Sr	0.08	0.03	0.07	0.32	0.83	0.41	0.86
r	0.23	0.09	0.20	0.90	2.33	1.16	0.15
s _I	0.14	0.089	0.15	1.49	2.00	2.06	3.28
%CV (k=2)	68.59	15.33	4.81	10.59	6.67	6.01	6.64

Manganese 403.076 nm
(mg.L⁻¹)

Precision	Material 1 (synthetic solution)	Material 2 (red wine)	Material 3 (Rosé wine)	Material 4 (red wine)	Material 5 (sparkling white wine)	Material 6 (rosé wine)	Material 7 (white wine)
Target value	0.25	0.54	0.67	1.34	2	3	4
Sr	0.019	0.008	0.006	0.012	0.015	0.016	0.020
r	0.054	0.023	0.018	0.034	0.042	0.045	0.017
s _I	0.023	0.011	0.021	0.028	0.051	0.092	0.153
%CV (k=2)	17.46	3.69	5.63	3.67	4.78	5.68	7.22

9.3 Trueness of the method

**COMPENDIUM OF INTERNATIONAL METHODS OF ANALYSIS – OIV
Simultaneous analysis of iron, copper, potassium, calcium and manganese in wines, using MP/AES (microwave-induced plasma atomic emission spectrometry)**

Accuracy profiles are established, graphically.

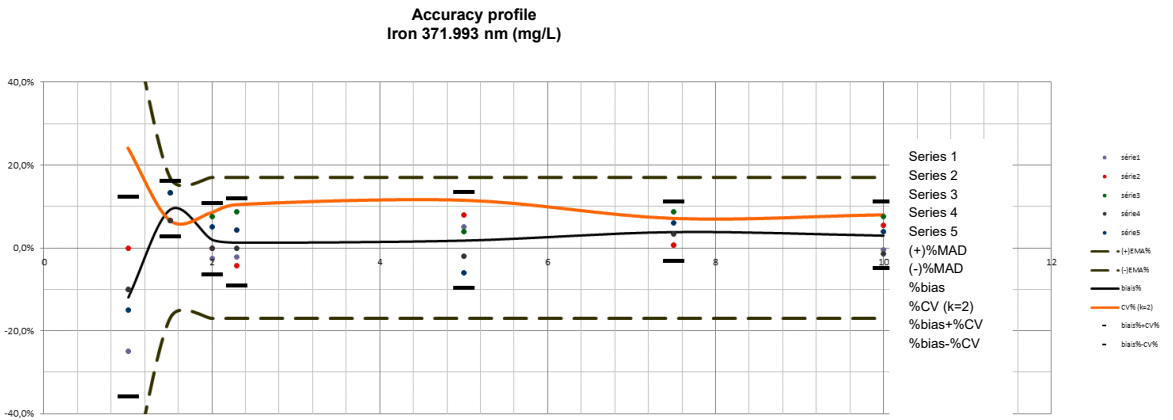
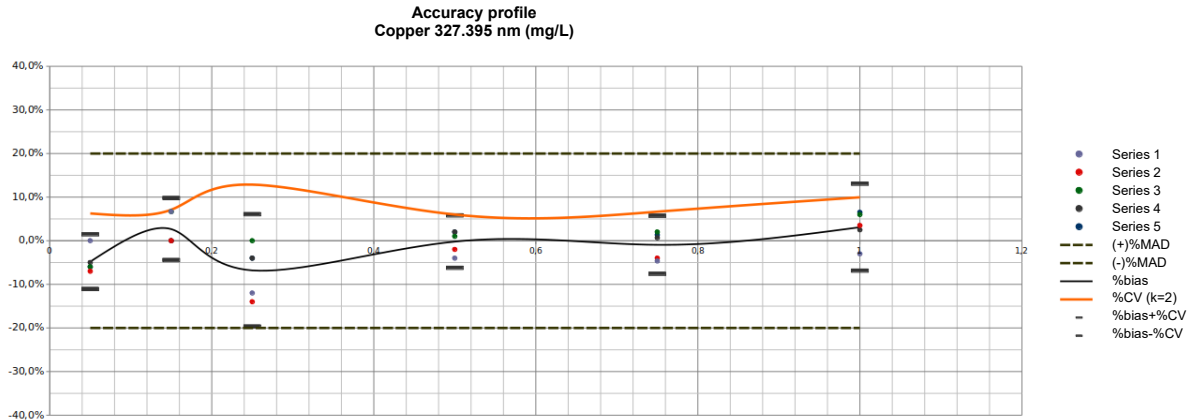

**Accuracy profile
Potassium 404.414 nm (mg/L)**

**COMPENDIUM OF INTERNATIONAL METHODS OF ANALYSIS – OIV
 Simultaneous analysis of iron, copper, potassium, calcium and manganese in wines, using MP/AES (microwave-induced plasma atomic emission spectrometry)**

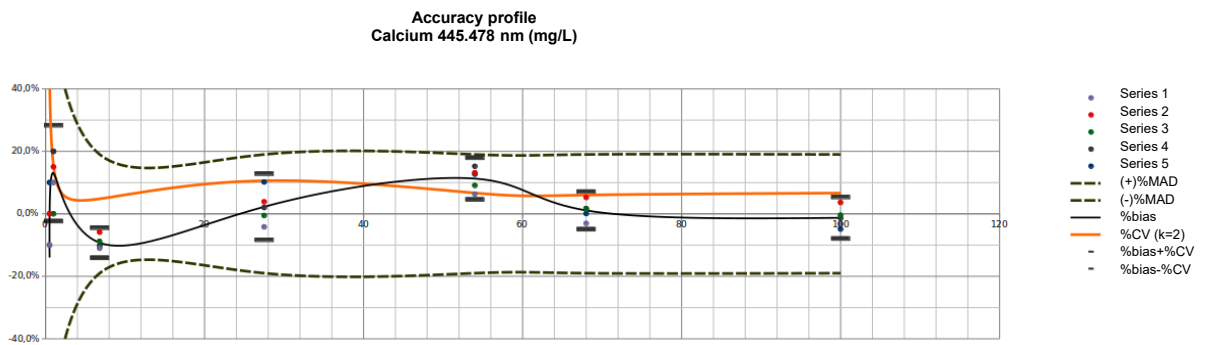
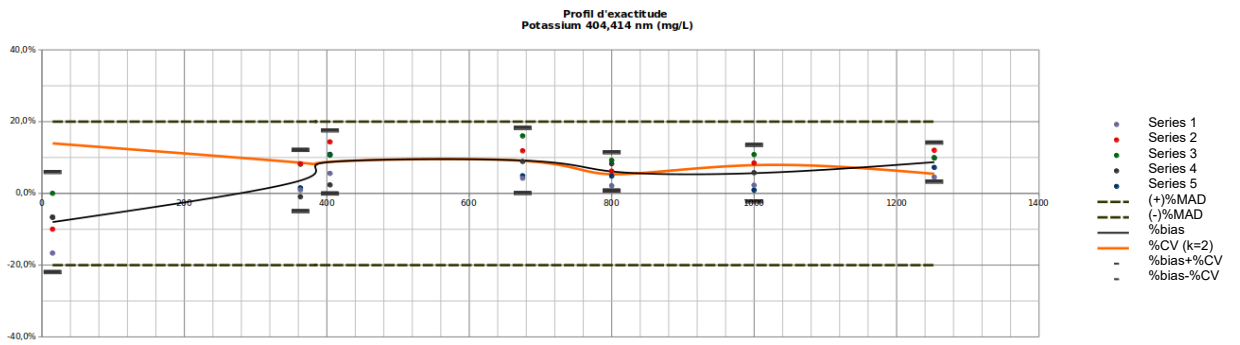

COMPENDIUM OF INTERNATIONAL METHODS OF ANALYSIS – OIV
Simultaneous analysis of iron, copper, potassium, calcium and manganese in wines, using MP/AES (microwave-induced plasma atomic emission spectrometry)

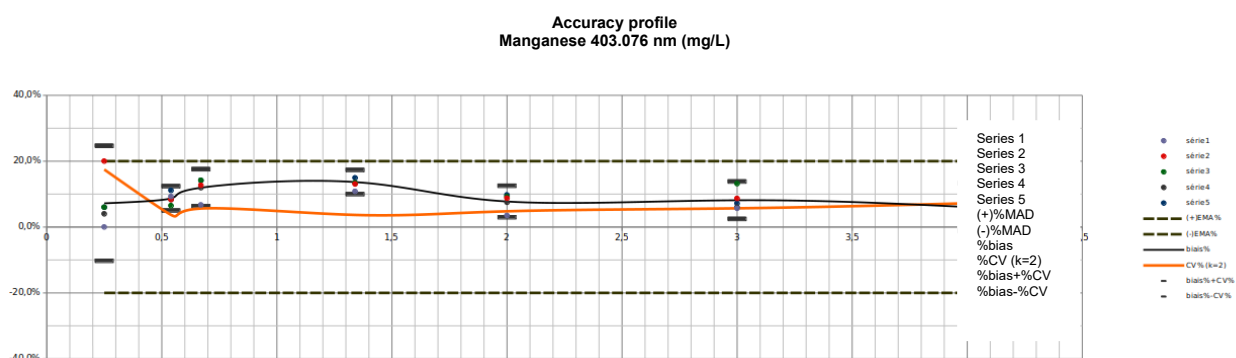

The verification of the trueness is carried out, for each concentration level, by comparing the interval produced by the intermediate precision around the value measured ($CV_{\text{precision}}$) with the interval of the MAD (Maximum Acceptable Deviation) around the reference value of the material. The trueness is accepted if the $CV_{\text{precision}}$ falls within the MAD. With regard to the MAD, the trueness tests are validated for all of the elements studied.

**COMPENDIUM OF INTERNATIONAL METHODS OF ANALYSIS – OIV
Simultaneous analysis of iron, copper, potassium, calcium and
manganese in wines, using MP/AES (microwave-induced plasma
atomic emission spectrometry)**

9.4 Limits of quantification

The limits of quantification (LOQ) are established by studying the range close to the low limit values. The value tested for the LOQ is validated if its %CV (k=2) < 60% (Resolution OIV-OENO 418-2013).

The following LOQ were validated:

mg.L ⁻¹	Method LOQ
Copper	0.05
Iron	1
Potassium	15
Calcium	1
Manganese	0.25

Microbiological Analysis of Wines and Musts

Detection, Differentiation and Counting of Micro-organisms

(Resolution OIV-OENO 206-2010)

Objective:

Microbiological analysis is aimed at following alcoholic fermentation and/or malolactic fermentation and detecting microbiological infections, and allowing the detection of any abnormality, not only in the finished product but also during the different phases of manufacture.

Comments:

All experiments must be carried out under normal microbiological aseptic conditions, using sterilized material, close to a Bunsen burner flame or in a laminar flow room and flaming the openings of pipettes, tubes, flasks, etc. Before carrying out microbiological analysis, it is necessary to ensure that the samples to be analyzed are taken correctly.

Field of application:

Microbiological analysis can be applied to wines, musts, mistelles and all similar products even when they have been changed by bacterial activity. These methods may also be used in the analysis of industrial preparations of selected microorganisms, such as dry active yeasts and lactic bacteria.

Microbiological analysis techniques:

- 1. Reagents and materials**
- 2. Installations and equipment**
- 3. Sampling**
- 4. Quality tests**
 - 4.1 objective**
 - 4.2 principle**
 - 4.3 procedure**
 - 4.3.1 air quality tests**
 - 4.3.2 incubator quality tests**
- 5. Microscopic techniques for the detection, differentiation of micro-organisms and direct counting of yeasts**
 - 5.1. Microscopic examination of liquids or deposits*

**COMPENDIUM OF INTERNATIONAL METHODS OF ANALYSIS -
OIV**

Microbiological analysis of wines and musts

5.2. *Gram staining for the differentiation of bacteria isolated from colonies (see paragraph 6)*

5.3. *Catalase Test for the differentiation of bacteria isolated from colonies (see paragraph 6)*

5.4. *Yeast cell count – haemocytometry*

5.5. *Yeast cell count – methylene blue staining of yeast cells*

6. Counting of micro-organisms by culture

6.1 *Detection, differentiation and enumeration of microorganisms (plate count)*

6.2. *Culture in liquid environment - "Most Probable Number" (MPN).*

1. REAGENTS AND MATERIALS

Current laboratory equipment and apparatus, as listed in ISO 7218:2007 - Microbiology of food and animal feeding stuff - General rules for microbiological examinations.

The following ones are recommended:

- Common laboratory materials and glassware, sterile (sterilized or ready-to-use sterile).
- Tubes (16x160 mm or similar) containing 9 ml sterile peptone water (Tryptone: 1 g/l) or other diluents to be used for serial sample dilutions.
- Ethanol to flame spreaders and tweezers.
- Hydrogen peroxide 3% solution.
- Micropipette holding sterile tips: 1 ml and 0.2 ml.
- L-shaped or triangular-shaped bent glass rods (hockey sticks) or plastic spreaders.
- Stainless steel tweezers, with flat edges.
- Sterile cellulose ester membranes (or equivalent) porosity 0.2 and 0.45 µm, 47 mm or 50 mm diameter, possibly with a printed grid on the surface, and packed singularly.
- Sterile cylinders.
- 10 ml sterile pipettes.

2. INSTALLATIONS AND EQUIPMENT

Current laboratory equipment and apparatus, as listed in ISO 7218:2007 - Microbiology of food and animal feeding stuff - General rules for microbiological examinations.

The following ones are recommended:

**COMPENDIUM OF INTERNATIONAL METHODS OF ANALYSIS -
OIV**

Microbiological analysis of wines and musts

- Microbiological cabinet or laminar flow cabinet. In the absence of this device, work in the proximity (within 50 cm) of a gas burner.
- Balance, with an accuracy of ± 0.01 g.
- Autoclave.
- Incubator with settings ranging from 25°C to 37°C.
- pH meter, with an accuracy of $\pm 0,1$ pH units and a minimum measuring threshold of $\pm 0,01$ pH units.
- Refrigerator(s), set at $5 \pm 3^\circ\text{C}$, and freezer(s), which temperature shall be below -18°C , preferably equal to $-24 \pm 2^\circ\text{C}$.
- Thermostatically controlled bath, set at $45 \pm 1^\circ\text{C}$
- Microwave oven.
- Optical microscope.
- Gas burner.
- Colony-counting device.
- Equipment for culture in a modified atmosphere (a sealed jar in which anaerobiosis can be made).
- Filtering apparatus with 47 mm or 50 mm diameter filters.
- "Vortex" stirrer or equivalent.
- Incubator for dry heat sterilisation
- Centrifuge
- Pump

3. SAMPLING

The sample must reproduce the microbiology of the whole mass of must or wine to be analyzed. As far as possible, the mass must be homogenized before sampling, in order to resuspend microorganisms that tend to set down to the bottom of the container. In case the homogenization is undesirable, samples must be taken from where the microorganisms are likely (or suspected) to be present (i.e. when searching for yeasts lying in the bottom of tanks or barrels), but in this case results are not quantitative. Before taking a sample from a tap, this latter must be flamed, and 2-3 litres liquid must be flushed. The sample must be put in a sterile.

The sample must be kept refrigerated and analysed as quickly as possible.

The following amounts of samples are required for the microbiological examination:

Must, or fermenting must or wine in storage:	not less than 250 ml;
Bottled or packed wine:	not less than one unit, whatever the capacity;

4. QUALITY TESTS

4.1 Objective

These tests are aimed at detecting the risk of microbial infection in advance.

4.2 Principle

**COMPENDIUM OF INTERNATIONAL METHODS OF ANALYSIS -
OIV**

Microbiological analysis of wines and musts

This technique is based on organoleptic and appearance changes (clouds, films, deposits, unusual colors) shown by wine when subjected to certain aeration and temperature conditions which can bring about microbiological activity. The nature of the changes should be confirmed by microscopic examination.

4.3 Operating method

4.3.1 Air quality tests

A 50 mL wine sample after filtration on coarse sterile filter paper is placed in a 150 mL sterile conical flask stoppered with cotton and left at an ambient temperature for at least 3 days. The clarity, color and possible presence of clouds, deposits and films are examined over this time. A microscopic examination is carried out in the case of cloud, deposit or film or a color change.

4.3.2 Incubator quality tests

A 100 mL wine sample, after filtration on coarse sterilized filter paper, is placed in 300 mL sterile conical flask stopped with cotton, put in an incubator at 30°C and examined after at least 72 hours. Organoleptic or visible changes can be indicative of microbial development. A microscopic examination must therefore be made.

5. MICROSCOPIC TECHNIQUES FOR THE DETECTION AND DIFFERENTIATION OF MICRO-ORGANISMS, AND FOR THE DIRECT COUNTING OF YEASTS

5.1 Microscopic examination of liquids or deposits

Objective:

Microscopic examination under cool conditions is aimed at detecting and differentiating the yeasts from the bacteria that might be present, in terms of their size and shape. Microscopic observation cannot distinguish between viable and non-viable microorganisms.

Comment:

With appropriate staining (see below), an estimation of the viable yeasts can be made.

Principle:

This technique is based on the magnification made by a microscope that allows the observation of micro-organisms, whose size is on the order of a micron.

Operation method:

Microscopic examination can be carried out directly on the liquid or on the deposit.

**COMPENDIUM OF INTERNATIONAL METHODS OF ANALYSIS -
OIV**

Microbiological analysis of wines and musts

Direct observation of the liquid will only be useful when the population is sufficiently high (more than 5×10^5 cells/mL).

When wine shows a lower microorganism population, it is necessary to concentrate the sample. Thus, about 10 mL of homogenized wine is centrifuged at 3000 - 5000 rpm for 5 to 15 minutes. After decanting the supernatant, the deposit is re-suspended in the liquid remaining at the bottom of the centrifugation tube.

To carry out the microscopic observation, a drop of the liquid sample or the homogenized deposit is placed on a clean glass slide with a Pasteur pipette or a sterilized wire. It is covered with a cover glass and placed on a slide on the stage of the microscope. Observation is made in a clear field, or preferably in phase contrast, which allows a better observation of detail. A magnification of x400 - x1000 is generally used.

5.2. Gram staining for the differentiation of bacteria isolated from colonies (see paragraph 6)

Objective:

Gram staining is used to differentiate between lactic bacteria (Gram positive) and acetic bacteria (Gram negative) and also to observe their morphology.

Comments:

It must be remembered that Gram staining is not sufficient to reach a conclusion, as other bacteria in addition to lactic and acetic bacteria may be present.

Principle:

This color is based on the difference in the structure and chemical composition of the cell walls between Gram positive and Gram negative bacteria. In Gram negative bacteria, the cell walls that are rich in lipids have a much reduced quantity of peptidoglycan. This allows the penetration of alcohol and the elimination of the gentian-violet-iodine complex, forming when the colorless cell is left, which will then be re-colored in red by saffron. Conversely, the cell walls of Gram positive bacteria contain a large quantity of peptidoglycan and a low concentration of lipids. Thus, the thick peptidoglycan wall and the dehydration caused by the alcohol do not allow the alcohol to eliminate the coloring of the gentian-violet-iodine complex.

Gram staining loses its usefulness if it is performed on a culture that is too old. Thus, the bacteria must be in an exponential growth phase within 24 to 48 hours. Gram staining is carried out after isolating the colonies and liquid cultivation.

Solutions:

The water used must be distilled.

1. Gentian violet solution

Preparation: Weigh 2g of gentian violet (or crystal violet), and put into a 100 mL conical flask and dissolve in 20 mL of 95% vol. alcohol. Dissolve 0.8g of ammonium oxalate in 80 mL of distilled water. Mix the two solutions together and

**COMPENDIUM OF INTERNATIONAL METHODS OF ANALYSIS -
OIV**

Microbiological analysis of wines and musts

only use after a period of 24 hours. Filter through paper at time of use. Keep out of light in a dark flask.

2. Lugol solution

Preparation: Dissolve 2g of potassium iodide in a minimal quantity of water (4 to 5 mL) and dissolve 1g of iodine in this saturated solution. Make the volume up to 300 mL with distilled water. Keep out of light in a dark flask.

3. Saffranin solution:

Preparation: Weigh 0.5g of saffranin in a 100 mL conical flask, dissolve with 10 mL of 95% vol. alcohol and add 90 mL of water. Stir. Keep out of light in a dark flask.

Operating method:

Smear preparation

Make a subculture of the bacteria in liquid or solid medium. Collect the young culture bacteria from the deposit (after centrifugation of the liquid culture) or directly from the solid medium with a loop or wire and mix in a drop of sterilized water.

Make a smear on a slide, spreading a drop of the microbial suspension. Let the smear dry, and then carry out fixation, rapidly passing the slide 3 times through the flame of a Bunsen burner, or equivalent. After cooling, perform staining.

Staining

Pour a few drops of gentian violet solution onto the fixed smear. Leave to react for 2 minutes and wash off with water.

Pour in 1 to 2 drops of lugol solution. Leave to react for 30 seconds. Wash with water and dry with filter paper.

Pour on 95% vol. alcohol, leave for 15 seconds. Rinse with water and dry with filter paper.

Pour on a few drops of saffranin solution, leave to react for 10 seconds. Wash with water and dry with filter paper.

Place a drop of immersion oil on the smear.

With the immersion objective, observe through a microscope in clear field.

Results:

Lactic bacteria remain violet or dark blue colored (Gram positive). Acetic bacteria are red colored (Gram negative).

5.3 Catalase Test for the differentiation of bacteria isolated from colonies (see paragraph 6)

Objective:

This test is aimed at making a distinction between acetic and lactic bacteria. The yeasts and acetic bacteria have a positive reaction. Lactic bacteria give a negative response.

Comments:

**COMPENDIUM OF INTERNATIONAL METHODS OF ANALYSIS -
OIV**

Microbiological analysis of wines and musts

It must be taken into account that the catalase test is insufficient as other bacteria in addition to lactic and acetic bacteria may be present.

Principle:

The catalase test is based on the property that aerobic micro-organisms have of decomposing hydrogen peroxide with release of oxygen:

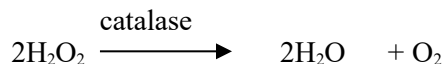

Reagent:

12 Volume hydrogen peroxide solution (3%)

Preparation: Measure 10 mL of 30% by volume hydrogen peroxide in a 100 mL calibrated flask and fill with freshly boiled distilled water. Stir and keep in the refrigerator in a dark flask. The solution must be freshly prepared.

Operating method:

Place a drop of 3% by volume hydrogen peroxide on a slide and add a small sample of young colony. If gas is released, it can be concluded that catalase activity is occurring in the culture. It is sometimes difficult to observe gas clearing immediately, particularly with bacterial colonies. It is therefore advisable to examine the culture through a microscope (objective x10).

5.4. Yeast cell count – Haemocytometry

5.4.1 Scope

Determination of yeast cell concentration in fermenting musts or wines, and ADY (Active Dry Yeast). A high cell concentration is required: at least 5×10^6 cells/ml. Fermenting musts and wines can be counted directly, ADY must be diluted 1000 or 10 000 times. Musts or wines containing fewer cells must be centrifuged (3000 g, 5 minutes) and the sediment resuspended in a known volume.

5.4.2 Principle

A drop of yeast cell suspension is placed on the surface of a slide with a counting chamber. The counting chamber has a defined volume and is subdivided in squares on the surface of the slide. Counting is made under a microscope in light field. Phase contrast is not indicated if cells are stained,

5.4.3 Reagents and materials

- Haemocytometer, double chamber, preferably with clips: Bürker, Thoma, Malassez, Neubauer.

**COMPENDIUM OF INTERNATIONAL METHODS OF ANALYSIS -
OIV**

Microbiological analysis of wines and musts

- Haemocytometer cover slip: common (0.17 mm width) cover slips are not suitable to this use, because they are flexible and do not guarantee that the chamber width is constant.
- Pipettes, fine tips, 1 and 10 ml volume.
- Volumetric flask, 100 ml.
- Beaker, 250 ml.

5.4.4 Installations and equipment

- Microscope with bright field illumination: magnification 250-500 x. Phase contrast is contraindicated.
- Magnetic plate and stirring bar.

Haemocytometers are available with different counting chambers: Bürker, Thoma, Malassez, Neubauer. Confirm the identity and the volume of the counting chamber to be used. Bürker, Thoma and Neubauer chambers have 0.1 mm depth, Malassez chamber is 0.2 mm deep.

Thoma chamber has one central large (1 mm²) square, so its volume is 0.1 mm³ (10⁻⁴ ml). This large square is subdivided in 16 squares, themselves further divided in 16 smaller squares. These small squares each have 0.05 mm x 0.05 side and 0.1 mm depth, so that the volume of each small square is 0.00025 mm³ (25 x 10⁻⁸ ml). It is also possible to count in the medium squares, each medium square having 16 small squares 0.2 x 0.2 mm, and 0.004 mm³ area, or 4 x 10⁻⁶ ml volume.

Bürker chamber contains 9 large 1mm² squares, which are divided into 16 0.2mm sided medium squares, separated by double lines with a 0.05mm spacing. The area of the medium squares is 0.04mm² and the volume is 0.004mm³. The area of the small squares formed by the double lines have an area of 0.025mm².

Big, medium and small squares of Neubauer, Thoma and Bürker chambers have the same size. Bürker chamber medium squares do not contain other lines inside; therefore they are probably the easiest to count.

5.4.5 Examination techniques

The counting chamber and the cover slip must be clean and dry before use. It may be necessary to scrub the ruled area, as dirty chambers influence the sample volume. Clean with demineralised water, or ethanol, and dry with soft paper.

If flocculent yeast has to be counted, the suspension medium must be 0.5% sulphuric acid, in order to avoid flocculation, but this impairs the possibility of methylene blue staining and the count of viable and dead cells. Resuspension can be carried out by sonification.

Put the sample on the slide using a fine tip pipette, following one of the two following procedures.

Procedure 1

**COMPENDIUM OF INTERNATIONAL METHODS OF ANALYSIS -
OIV**

Microbiological analysis of wines and musts

Mix well the yeast suspension. If dilutions are required, make decimal dilutions, as usual. If a methylene blue stain is performed, make it on the most diluted sample and mix 1 ml sample with 1 ml methylene blue solution.

Constantly shake the yeast suspension. Take a sample with a fine tip pipette, expel away 4-5 drops of suspension and place a small drop of yeast suspension (diluted if necessary) on each of the two ruled areas of the slide. Cover it with the cover slip within 20 seconds and press firmly with the clips. The counting area should be completely filled, but no liquid should extend to the moat.

Procedure 2

Place the rigid cover slip so that both counting chambers are equally covered. Use the clips to press the cover slip against the support areas until iridescence lines (the Newton rings) appear. When there are no clips, do not move the cover slip when filling the chamber.

Constantly shake the yeast suspension. Take a sample with a fine tip pipette, expel away 4-5 drops of suspension and allow a small drop of sample to flow between the haemocytometer and the cover slip. Do the same in the other part of the slip. The counting area should be completely filled, but no liquid should extend to the moat.

Let the prepared slide stand for three minutes for the yeast cells to settle, and place it under the microscope.

Count 10 medium squares in each ruled area, standardizing procedures must be set, in order to avoid counting twice the same square. Cells touching or resting on the top or right boundary lines are not counted, those resting on bottom or left boundary lines are counted. Budding yeast cells are counted as one cell if the bud is less than one-half the size of the mother cell, otherwise both cells are counted.

To obtain accurate cell counts, it is advisable to count 200 – 500 total yeast cells, on average. Counts from both sides of the slide should agree within 10%. If a dilution is used, the dilution factor must be used in the calculation.

5.4.6 Expression of results

If C is the average number of cells counted in one medium square with 0.2 mm sides, the population T total in the sample is :

Expressed as cells/mL $T = C \times 0.25 \times 10^6 \times \text{dilution factor}$

If C is the average number of cells counted in one small square with 0.05mm sides, the population T total in the sample is:

Expressed as cells/mL $T = C \times 4 \times 10^6 \times \text{dilution factor}$

5.4.7 References

European Brewery Convention. Analytica Microbiologica – EBC. Fachverlag Hans Carl, 2001

5.5 Yeast cell count – Methylene blue staining of yeast cells

5.5.1 Scope

This method allows a rapid estimation of the percentage of viable yeast cells, which are not stained, because dead cells are blue-stained. The method is applicable to all samples containing yeasts, except musts containing more than 100 g/l sugar. Bacteria are too small and their staining is not visible with this method.

Note: a good focus should be achieved at various depths, in order to properly see their coloring with methylene blue.

5.5.2 Principle

Methylene blue is converted into its colourless derivative by the reducing activity of viable yeast cells. Dead yeast cells will be stained blue.

Viability is calculated from the ratio between the number of viable cells and the total number of cells. The method overestimates “real” viability when viable cells are less than 80%, because it does not distinguish between “live” cells and their ability to reproduce (Viable But Not Culturable cells).

If the sugar concentration is higher than 100 g/l, most cells are light blue, therefore this method is not recommended.

If wine has low pH and is strongly buffered, the dye cannot work properly. In this case the count must be applied at least to the first decimal dilution.

5.5.3 Reagents and materials

Solution A: Methylene blue distilled water solution, 0.1 g/500 ml.

Solution B: KH_2PO_4 , distilled water solution, 13.6 g/500 ml.

Solution C: $\text{Na}_2\text{HPO}_4 \times 12 \text{H}_2\text{O}$ distilled water solution, 2.4 g/100 ml

Solution D: 498.75 ml Solution B + 1.25 ml solution C.

Solution E: Mix the 500 ml of solution D with 500 ml solution A to give final buffered methylene blue solution, with pH approximately 4.6.

5.5.4 Installations and equipment

Microscope, 250-500 x magnifications. Phase contrast is contraindicated.

Microscope slides and cover slips, or haemocytometer (Thoma, Bürker or Neubauer chamber).

Test tube and stirring rod.

Pipettes, fine tips.

5.5.5 Examination techniques

Viability determination

Dilute the suspension of yeast with methylene blue solution in a test tube until the suspension has approximately 100 yeast cells in a microscopic field. Place a small

**COMPENDIUM OF INTERNATIONAL METHODS OF ANALYSIS -
OIV**

Microbiological analysis of wines and musts

drop of well-mixed suspension on a microscope slide and cover with a cover slip. Examine microscopically using a magnification of 400 x within 10 minutes contact with the stain.

Count a total of 400 cells (T), noting the number of blue coloured (C) dead, broken, shrivelled and plasmolyzed cells. Budded yeast cells are counted as one cell if the bud is less than one half the size of the mother cell. If the bud is equal or greater than one half the size of the mother cell, both are counted. Cell stained light blue should be considered alive.

5.5.6 Expression of results

If T is the total cell number and C the blue coloured cell number, then the percentage of viable cells is $\frac{T - C}{T} \times 100$

5.5.7 References

European Brewery Convention. *Analytica Microbiologica* – EBC. Fachverlag Hans Carl, 2001

6. COUNTING OF MICRO-ORGANISMS BY CULTURE

Objective:

The purpose of counting of microorganisms by culture is to evaluate the level of contamination of the sample, that is to say, to estimate the quantity of viable microorganisms. According to the culture media used and the culture conditions, four types of microorganisms can be counted, namely, yeasts, lactic bacteria, acetic bacteria and mould.

Principle:

Enumeration by culture is based on the fact that micro-organisms are able to grow in a nutrient medium and incubation conditions suitable to form colonies on the medium solidified by agar, or turbidity in a liquid medium. On an agar medium a cell produces by proliferation a cluster of cells visible to the naked eye called colony.

6.1 Detection, differentiation and enumeration of microorganisms (plate count).

6.1.1 Scope

This standard gives general guidance for the enumeration of viable yeasts, moulds and lactic or acetic bacteria in musts, concentrated musts, partially fermented musts, wines (including sparkling wines) during their manufacture and after bottling, by counting the colonies grown on a solid medium after suitable incubation. The purpose

**COMPENDIUM OF INTERNATIONAL METHODS OF ANALYSIS -
OIV**

Microbiological analysis of wines and musts

of microbiological analysis is to control the winemaking process and prevent microbial spoilage of musts or wines.

6.1.2 Terms and definitions

The terms “plate” and “Petri dish” are used as synonyms.

CFU = Colony Forming Units.

6.1.3 Method

The number of viable microorganisms present in musts or wines is determined by spreading a small known volume of sample on the surface of a culture medium or adding it as per the incorporation method (see par. 9.5 6.1.7.4), and incubating the plates for the required time in the better conditions for the growth of the microorganisms. Each cell, or cluster of cells, divides and gathers into a cluster and becomes visible as a colony. The number of colonies found on the surface of a plate states for the cells occurring in the original sample so that the results are reported as CFU. If the number of cells in a sample is supposed to be high, suitable serial decimal dilutions are performed in order to obtain colonies ranging from 15-10 to 300 per plate. If the number of CFU in a sample is supposed to be low, they are collected on the surface of a sterile 0.45 to 0.88 µm filter for yeasts of 0.22 to 0.45 µm and for bacteria, which is then placed in the Petri dish on the surface of the culture medium.

The measuring range of this method rises from < 1 CFU/(analyzed volume) to 10⁹ CFU/ml or 10¹⁰ CFU/g in the original sample.

6.1.4 Reagents and materials

As indicated in paragraph 1 of the resolution, plus:

- Tubes (16x160 mm or similar) containing 9 ml sterile peptone water (Tryptone: 1 g/l) or other diluents to be used for serial sample dilutions (Appendix 4). An indicative number of tubes required for the following samples is reported below:

Unfermented musts: 4 / sample.

Fermenting musts: 7 / sample.

Wines in storage: 2 / sample.

- Micropipette holding sterile tips: 1 ml and 0.2 ml.

- L-shaped or triangular-shaped bent glass rods (Drigalski rods) or plastic spreaders.

- 90-mm diameter Petri dishes (56 cm²) (with 15-20 ml of growth medium) for pour plate technique, and 90-mm or 60-mm diameter plates (with 6-8ml of growth medium) for membrane filter technique, filled 18-24 h in advance with 15-20 ml of culture medium (simple or double dishes are required for each sample tested):

- For yeasts counts use: YM, YEPD, WL Nutrient Agar, YM Agar or TGY Agar. If searching non-*Saccharomyces* yeasts, Lysine Agar and WL

**COMPENDIUM OF INTERNATIONAL METHODS OF ANALYSIS -
OIV**

Microbiological analysis of wines and musts

Differential Agar plates (AppendixAppendix 5, culture medium) or equivalent if validated.

- For acetic acid bacteria counts use: GYC agar, G2 or Kneifel medium (AppendixAppendix 5, culture medium) or equivalent if validated
- For lactic acid bacteria counts use: MRS plus 20% tomato (or apple- or grape-) juice, or modified ATB Agar (medium for *Oenococcus oeni*), or TJB plus agar, or Milieu Lafon-Lafourcade, milieu 104, MTB agar (AppendixAppendix 5 culture medium) or equivalent if validated
- For filamentous fungi counts use Czapek-Dox modified agar, DRBC agar or MEA added with tetracycline (100 mg/l) and streptomycin (100 mg/l). (Appendix 5 culture medium) or equivalent if validated
- Antibiotics must be added in order to make the counting selective since all the microorganisms are together in wine.(see Appendix I culture media)

6.1.5 Installations and equipment

As indicated in paragraph 2 of the resolution.

6.1.6 Sampling

As indicated in paragraph 3 of the resolution

The following amounts of samples are required for the plate counting:

Must, or fermenting must or wine in storage: not less than 250 ml;
Bottled or packed wine: not less than one unit,
whatever the capacity;

6.1.7 Examination techniques

6.1.7.1 Preliminary requisites

All the materials and equipments used in the tests must be sterile, and aseptic condition must be kept during all operations.

The laminar flow cabinet must be switched on 5 minutes before starting the work, in order to have a sterile and stable air flow.

6.1.7.2 Sterilization

Culture media must be sterilized in autoclave at 121°C for at least 15 minutes (20 minutes for large volumes). Single-use sterile materials and glassware must be opened and used under laminar flow cabinet. Tweezers and spreading devices must be immersed in ethanol and flamed before use. Stainless steel funnels must be flamed with ethanol after each use, while glass- and polycarbonate funnels must be autoclaved before use, so these ones must be available in the same number as the tested samples.

**COMPENDIUM OF INTERNATIONAL METHODS OF ANALYSIS -
OIV
Microbiological analysis of wines and musts**

6.1.7.3 Sample dilution (Appendix 1)

One ml of sample is pipetted in a sterile 9 ml peptone water tube. The tube is stirred with the aid of a “vortex” shaker for 20 seconds. This is the first (decimal) dilution, from which 1 ml is transferred to the next 9-ml sterile peptone water tube, which is the second dilution. After 20 seconds shaking, the operation is repeated until necessary.

The indicative number of serial dilutions required for the following samples is reported below:

Unfermented musts: dilutions.	4 decimal
Fermenting musts: dilutions.	7 decimal
Unfiltered wines during ageing (Yeast counts): dilutions.	2 decimal
Unfiltered wines during ageing (Lactic Acid Bacteria counts) : dilutions.	6 decimal
Filtered wines or packed (bottled) wines dilution.	No
Concentrated musts	Dilute 10 ml in 100 ml peptone water (or 100ml in 1000ml).

Bottled or filtered wines, and concentrated musts after dilution in sterile peptone water, are analyzed with membrane filter technique.

6.1.7.4 Plating

The necessary serial dilutions are prepared for the number of samples to be plated. Multiple serial dilutions can be prepared, if many samples have to be plated, but any dilution must be plated within 20 minutes.

Inoculate each plate with 0.1 or 0.2 ml of the three lowest dilutions prepared, as follows:

Unfermenting musts	dilutions -2; -3; -4.
Fermenting musts	dilutions -5; -6; -7.
Unfiltered wines during ageing	dilutions 0; -1; -2.

In doubt, inoculate a higher number of dilutions, never a lower.

Under aseptic conditions (preferably under a laminar flow cabinet) spread the sample on the surface of the culture media before the liquid is absorbed (usually within 1-2 minutes) with a sterile bent glass rod (Drigalski rods) or a single-use one. A separate “hockey stick” must be used for each plate, or the plate must be spread starting with the most diluted sample and proceeding to the least dilute ones. Leave the plates some minutes under sterile air flow, until the liquid is absorbed.

**COMPENDIUM OF INTERNATIONAL METHODS OF ANALYSIS -
OIV
Microbiological analysis of wines and musts**

Note 1: Plating 0.2 ml instead of 0.1 ml, as frequently reported, allows an easier spreading and a delayed one. Calculations must consider this.

Note 2: For the enumeration of yeast Bacterial growth is avoided by adding 50 mg/l chloramphenicol (or equivalent if validated) to growth media, after autoclaving it, and the mold by adding biphenyl 150mg/L (or equivalent if validated).

Note 3: For the enumeration of lactic acid bacteria, yeasts growth is prevented by the addition of natamycin (pimaricin) (0.1 g/L) (or equivalent if validated) and acetic bacteria by anaerobic incubation.

Note 4: For the enumeration of acetic bacteria, the growth of yeast is prevented by the addition of natamycin (pimaricin) (0.1 g/L) (or equivalent if validated) and that of lactic acid bacteria with the addition of penicillin (12.5 mg/L) (or equivalent if validated) .

The addition of antibiotics is done after the autoclave sterilization.

If a specific research of non-*Saccharomyces* yeast is performed, inoculate as previously described, three Lysine Agar plates and three WL Differential Agar plates with the appropriate dilutions

- Incorporation method (alternative method).

Prepare and sterilize 15 ml of medium in tubes, and keep the tubes in a water bath (or equivalent if validated) at $47\pm 1^{\circ}\text{C}$.

Pour 1 ml of sample or dilution in an empty Petri dish.

Add 15 ml culture medium and stir gently the Petri dish, so as to obtain a homogeneous distribution of microorganisms within the mass of the medium.

Allow to cool and solidify by placing the Petri dishes on a cool horizontal surface (the solidification time of the agar shall not exceed 10 min).

6.1.7.5 Enumeration with concentration by membrane filtration

Membrane porosity must be 0.45 or 0.8 μm for yeast counting; 0.2 or 0.45 μm for counting bacteria. Membrane surface must be preferably be cross-hatched, in order to facilitate the colony counting.

The plates, on which the membranes are put, can contain an agar nutrient medium or a pad, in which the dry medium is dispersed, that must be soaked with sterile water just before the use. Some suppliers give sterile plates containing a sterile pad, on which the content of 2-ml of single-use sterile liquid medium is poured just before the use.

**COMPENDIUM OF INTERNATIONAL METHODS OF ANALYSIS -
OIV**

Microbiological analysis of wines and musts

Aseptically assemble the filtration equipment, sterilize the funnel according to 9.2, and connect to the vacuum-producing system.

Dip the tweezers in ethanol and flame them: when the flame is extinguished, wait some seconds and put the membrane, with the tweezers, on its holder of the filtration unit.

Before opening the bottle, shake it well; dip the bottleneck upside-down in ethanol (1-2 cm) and flame to sterilize it.

Of each sample three amounts: 10 ml with a sterile 10-ml pipette, 100 ml with a sterile cylindrical 100-ml pipette, and the rest direct from the bottle, if possible. To filter the wine, pour the wine into the funnel.

When the desired amount of wine has been filtered, release the vacuum, flame the tweezers, open the funnel, keep the membrane with the tweezers, put its opposite edge on the solid medium of a plate and make it adhere to the medium surface, avoiding bubble formation beneath.

6.1.7.6 Sample incubation

Incubate the plates, upside-down, aerobically 4 days at 25 ± 2 °C, for yeast or for acetic acid bacteria. If temperature is < 23 °C extend incubation one more day, if temperature is < 20 °C extend three more days. The maximum temperature must not exceed 28°C.

In case of performing *Brettanomyces* (or *Dekkera*) yeast counts, increase twofold the incubation time.

In case of performing LAB count, put the plates in an anaerobic jar or bag, and incubate the plates upside-down 10 days at 30 ± 2 °C. If temperature is < 28 °C extend incubation one more day, if it is < 25 °C extend three more days. The maximum temperature must not exceed 33°C.

6.1.8 Expression of results

6.1.8.1 Counting yeast colonies and bacteria.

Count the colonies grown in 4 days for the yeast and acetic acid bacteria (8 days for *Brettanomyces/Dekkera* yeasts), and 10 days for lactic bacteria, if necessary with the aid of a colony counter, ignoring the different colony morphology if performing a total yeast count, or considering it, if required.

The media and incubation conditions are specific enough for it to be possible to count the different types of micro-organisms in the colonies visible to the naked eye.

6.1.8.2 Calculation of results.

The most reliable results come from counting plates containing from 10 to 300 colonies (ISO 7218:2007 - Microbiology of food and animal feeding stuff - General rules for microbiological examinations).

**COMPENDIUM OF INTERNATIONAL METHODS OF ANALYSIS -
OIV**

Microbiological analysis of wines and musts

Calculate the number N of microorganisms present in the test sample as a weighted mean from two successive dilutions using the following equation:

$$N = \frac{\sum C}{V \times 1,1 \times d}$$

where:

$\sum C$ is the sum of colonies counted on the two dishes retained from two successive dilutions, at least one of which contains a minimum of 10 colonies.

V is the volume of the inoculum placed in each dish, in millilitres.

d is the dilution corresponding to the first dilution retained [$d=1$ when the undiluted liquid product (test sample) is retained].

In other words, if plates from two consecutive decimal dilutions contain 10-300 colonies, compute the number of CFU/ml for each dilution, and then the average of the two values: this is the CFU/ml value of the sample. If one value is greater than the double of the other, keep the lower one as CFU/ml.

Round off the results to two significant figures only at the time of conversion to CFU/ml, and express the results as a number between 1,0 and 9,9 multiplied by the appropriate power of 10 (ISO 7218:2007 - Microbiology of food and animal feeding stuff - General rules for microbiological examinations).

If samples were inoculated in duplicate series, and one or two plates, inoculated with the same dilution, contain colonies, compute the average of the number of colonies and multiply by the reciprocal of the dilution factor, to obtain the number of CFU/ml. If there is no plate containing 10-300 colonies, and all plates contain more than 300 colonies, count the less crowded ones. If they contain less than 10 colonies/cm², count 12 squares of 1 cm² and multiply the average by 56 (the area of a 90-mm diameter plate); if colonies are more crowded, count 4 squares of 1 cm² and multiply the average by 56. Express the results as "Estimated CFU/ml". Do not express the results as TNTC (Too numerous to count) whenever possible.

If the only plates containing colonies contains less than 10 colonies, but at least 4, calculate the result as given in the general case, and report it as "Estimated CFU/ml".

If the total is from 3 to 1, the precision of the result is too low, and the result shall be reported as "(the searched microorganisms) are present but less than $4 \times d$ CFU/ml".

If plates from all dilutions of any sample have no colonies, report the results as "less than $1/d$ CFU/ml", but consider the possible presence of inhibitors in the sample.

When performing membrane filtration technique, express the results referring to the amount of filtered liquid, e.g. CFU/bottle, CFU/100 ml, or CFU/10ml.

**COMPENDIUM OF INTERNATIONAL METHODS OF ANALYSIS -
OIV**

Microbiological analysis of wines and musts

6.1.9 Uncertainty of measure

6.1.9.1 Criteria of controlling the results.

For each lot of medium, one plate is used as sterility control after sterilization. One plate per each culture medium used during the tests, is left opened under laminar flow cabinet during all operations, as a sterility check of the working environment. That plate will be incubated as the inoculated ones.

Periodically, one sample is inoculated in double, and the experimental K_p is calculated with the following equation:

$$Kp = \frac{|C_1 - C_2|}{\sqrt{C_1 + C_2}}$$

where C_1 and C_2 are the results of the two counts.

If $Kp < 1.96 \approx 2.0$ the results are acceptable: the average of the two counts can be used as the result.

If $2.0 < Kp \leq 2.576 \approx 2.6$ the difference of the two counts is critical, and must be carefully evaluated before accepting the results as the average of the two counts.

If $Kp > 2.6$ the difference of the two counts is anomalous. The result is rejected and the test must be repeated. In such event the person in charge of the laboratory must examine all the results obtained after the last acceptable ones.

6.1.9.2 Uncertainty of measure

If the number of counted colonies in the countable plate is lower than 10, the result is acceptable, but the population of colonies is considered to follow the Poisson distribution. The 95% confidence level, and consequently the uncertainty of measure, of the estimated count made on a single Petri dish, is reported in the following table.

Number of colonies	Confidence limit at 95% level		Percent error of the limit *	
	Lower	Upper	Lower	Upper
1	<1	6	-97	457
2	<1	7	-88	261

**COMPENDIUM OF INTERNATIONAL METHODS OF ANALYSIS -
OIV
Microbiological analysis of wines and musts**

3	<1	9	-79	192
4	1	10	-73	156
5	2	12	-68	133
6	2	13	-63	118
7	3	14	-60	106
8	3	16	-57	97
9	4	17	-54	90
10	5	18	-52	84
11	6	20	-50	79
12	6	21	-48	75
13	7	22	-47	71
14	8	24	-45	68
15	8	25	-44	65
* Compared to the microorganism count (1 st column)				

If the colony count is >10, the confidence limit at a *p* probability level is calculated with the following equation:

$$C = C_i \pm K_p \sqrt{C_i}$$

where C_i is the number of colonies on the plate, and K_p is the coverage factor. Usually the coverage factor is 2, or 1.96. *C* value is calculated from each plate and multiplied by the number of dilutions, together with the result of the count.

6.2. Culture in liquid medium- "Most Probable Number" (MPN)

6.2.1 Objective

The purpose of this technique is to evaluate the number of viable microorganisms in wines having high contents of solid particles in suspension and/or high incidence of plugging.

6.2.2 Principle

This technique is based on the estimation of the number of viable microorganisms in liquid medium, starting from the principle of its normal distribution in the sample.

6.2.3 Diluents and liquid culture media (see Appendices 4 and 5)

6.2.4 Operating method

Several quantitative and successive solutions are prepared and following this, after incubation, a certain proportion of tests will not lead to any growth (negative tests), while others will begin to grow (positive tests). If the sample and the dilutions are homogeneous, and if the number of dilutions is sufficiently high, it is possible to treat the results statistically, using suitable tables (tables based on

**COMPENDIUM OF INTERNATIONAL METHODS OF ANALYSIS -
OIV**

Microbiological analysis of wines and musts

McCready's probability calculations), and to extrapolate this result to the initial sample.

6.2.5 Preparation of dilutions

Starting from a sample of homogenized wine, prepare a series of decimal dilutions ($1/10$) in the diluent.

Take 1 mL of wine and add to 9 mL of diluent in the first tube. Homogenize. Take 1 mL of this dilution to add to 9 mL of diluent in the second tube. Continue this dilution protocol until the last suitable dilution, according to the presumed microbial population, using sterilized pipettes for each dilution. The dilutions must be made until extinction, i.e. the absence of development in the lowest dilutions (*appendix 2*).

6.2.6 Preparation of inoculations

Inoculate 1 mL of wine and 1 mL of each of the prepared dilutions, mixed at the time, in, respectively, 3 tubes with the appropriate culture medium (*appendix 5*). Mix thoroughly.

Incubate the inoculated tubes in the incubator at 25°C for yeasts (3 days, up to 10 days), under aerobic conditions, and for lactic bacteria, under anaerobic or microaerophilic conditions (8 days, up to 10 days), making periodic observations up to the last day of incubation.

6.2.7 Results

All those tubes that show a microbial development leading to the formation of a whitish deposit, more or less evident and/or with a more or less marked disturbance are considered as positive. The results must be confirmed by observation through a microscope. Specify the incubation period.

The reading of the tubes is made by noting the number of positive or negative tubes in each combination of three tubes (in each dilution). For example, "3-1-0" signifies: 3 positive tubes in the 10^0 dilution (wine), 1 in the 10^{-1} dilution and zero in the 10^{-2} dilution.

For a number of dilutions higher than 3, only 3 of these results are significant. To select the results allowing for the determination of the "MPN", it is necessary to determine the "typical number" according to the examples in the following table:

**COMPENDIUM OF INTERNATIONAL METHODS OF ANALYSIS -
OIV
Microbiological analysis of wines and musts**

Table:

	Number of positive tubes for each dilution					Typical number
<i>Example</i>	10	10	10	10	10	3-1-0
a	3	3	3	1	0	3-2-0
a	3	3	2	0	0	3-2-1
a	3	2	1	0	0	3-0-1
a	3	0	1	0	0	3-2-3
b	3	2	2	1	0	3-2-3
b	3	2	1	1	0	3-2-2
c	2	2	2	2	0	2-2-2
d	0	1	0	0	0	0-1-0
<p>Example a : take the greatest dilution for which all the tubes are positive and the two following ones.</p> <p>Example b : if a positive result is achieved for a dilution that is bigger than the last chosen dilution, it must be added.</p> <p>Example c : if no dilution achieves three positive tubes, take the dilutions that correspond to the last three positive tubes.</p> <p>Example d : instance of a very small number of positive tubes. Choose the typical number so that the positive dilution is in the ten's row.</p>						

Adapted from Bourgeois, C.M. and Malcoste, R. *in* : Bourgeois, C.M. et Leveau, J.Y. (1991).

Calculation of the Most Probable Number (MPN)

Taking account of the typical number obtained, the MPN is determined through Table A (*Appendix 3*) based on McCrady's probability calculations, considering the dilution made. If the dilution series is 10^0 ; 10^{-1} ; 10^{-2} the reading is direct. If the dilution series is 10^1 ; 10^0 ; 10^{-1} the reading is 0.1 times this value. If the dilution series is 10^{-1} ; 10^{-2} ; 10^{-3} ; the reading is 10 times this value.

Comment:

If there is a need to increase the sensitivity, a concentration 10^1 of wine can be used. To obtain this concentration of microorganisms in 1 mL, centrifuge 10 mL of wine and take 1 mL of deposit (after having taken 9 mL of excess liquid) and inoculate according to the previously described method.

6.2.8 Expression of Results

The microorganism content of wine must be expressed in cells per mL, in scientific notation to one decimal place. If the content is lower than 1.0 cells per mL, the result must be presented as "<1.0 cells per/mL".

(See annexes on following pages)

**COMPENDIUM OF INTERNATIONAL METHODS OF ANALYSIS -
OIV
Microbiological analysis of wines and musts**

7. BIBLIOGRAPHY

- ISO 4833:2003. Microbiology of food and animal feeding stuffs – Horizontal medium for the enumeration of microorganisms – Colony count technique at 30°C.
- ISO 7218:2007 - Microbiology of food and animal feeding stuff - General rules for microbiological examinations.
- ISO 7667:1983. Microbiology - Standard layout for methods of microbiological examination.
- Pallman, C., J. B. Brown, T. L. Olineka, L. Cocolin, D. A. Mills and L. F. Bisson. 2001. Use of WL medium to profile native flora fermentations. *American Journal of Enology and Viticulture* 52:198-203;
- A. Cavazza, M. S. Grando, C. Zini, 1992. Rilevazione della flora microbica di mosti e vini. *Vignevini*, 9-1992 17-20.- ANDREWS, W. et MESSER, J. (1990). *Microbiological Methods*. in : AOAC Official Methods of Analysis, 15th edition, 1, 425-497, Association of Analytical Chemist, Washington.
- BIDAN, P. (1992). *Analyses Microbiologiques du Vin*. F.V. O.I.V. n° 910, Paris.
- BOURGEOIS, C.M. et LEVEAU, J.Y. (1991). *Techniques d'analyse et de contrôle dans les industries agro alimentaires*, 2ème édition, 3. Le Contrôle Microbiologique Lavoisier, Tec. & Doc., APRIA Ed. Paris.
- CARR, J. G. (1959). Acetic acid bacteria in ciders. *Ann. Rep. Long Ashton Res. Sta.*, 160.
- DE MAN, J. C. (1975). The probability of most probable number. *European Journal of Applied Microbiology*, 1, 67-78.
- LAFON-LAFOURCADE, S. et al. (1980). Quelques observations sur la formation d'acide acétique par les bactéries lactiques. *Conn. Vigne Vin*, 14, 3, 183-194.
- MAUGENET, J. (1962). Les Acétobacter du cidre. Identification de quelques souches. *An. Technol. Agric.*, 11, 1, 45-53.
- PLARIDIS et LAFON-LAFOURCADE, S. (1983). Contrôle microbiologique des vins. *Bull. O.I.V.*, 618, 433-437, Paris.
- RIBÉREAU-GAYON, J. et PEYNAUD, E. (2004). *Traité d'Oenologie*, Tome 2, Librairie Polytechnique CH. Béranger, Paris et Liège.
- *Standard Methods for the Examination of Water and Waste Water* (1976). 14th edition, American Public Health Association, Incorporated, New York.
- *Standard Methods for the Examination of Water and Waste Water* (1985). 16th edition, American Public Health Association, DC 20005, Washington.

**COMPENDIUM OF INTERNATIONAL METHODS OF ANALYSIS -
OIV**

Microbiological analysis of wines and musts

- VAZ OLIVEIRA, M., BARROS, P. et LOUREIRO, V. (1995). Analyse microbiologique du vin. Technique des tubes multiples pour l'énumération de micro-organismes dans les vins - "Nombre le plus probable" (NPP), F.V. O.I.V. n° 987, Paris.
- VAZ OLIVEIRA, M. et LOUREIRO, V. (1993). L'énumération de micro-organismes dans les vins ayant un indice de colmatage élevé, Compte rendu des travaux du groupe d'experts "Microbiologie du Vin" de l'O.I.V., 12ème session, annexe 2, Paris.
- VAZ OLIVEIRA, M. et LOUREIRO, V. (1993). L'énumération de micro-organismes dans les vins ayant un indice de colmatage élevé, 2ème partie, Doc. Travail du groupe d'experts "Microbiologie du Vin" de l'O.I.V., 13ème session, Paris.

Annex 1

Preparation of dilutions and inoculations

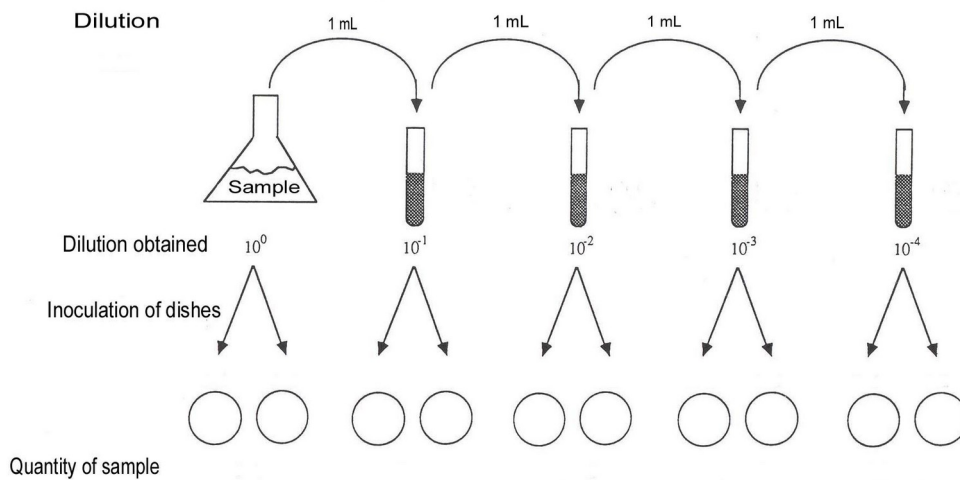

Appendix 2

Preparation of dilutions and inoculations

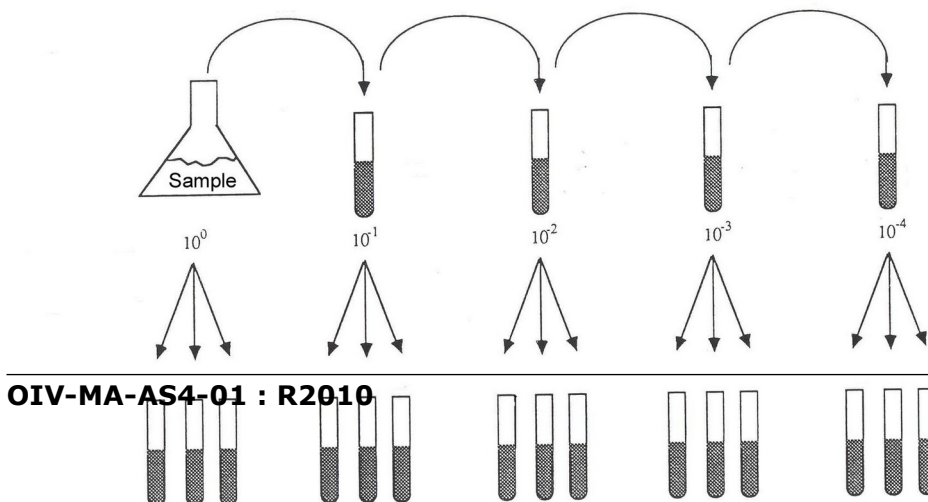

**COMPENDIUM OF INTERNATIONAL METHODS OF ANALYSIS -
OIV**

Microbiological analysis of wines and musts

Appendix 3

TABLE A

"Most Probable Number" (MPN) for 1 mL sample utilizing 3 tubes
with 1 mL, 0.1 mL et 0.01 mL

Positive tubes				Positive tubes				Positive tubes			
1 mL	0,1 mL	0,01 mL	MP N 1 mL	1 mL	0,1 mL	0,01 mL	MP N 1 mL	1 mL	0,1 mL	0,01 mL	MPN 1 mL
0	0	0	0,0	2	0	2	2,0	1	1	1	7,5
0	0	1	0,3	2	1	0	1,5	3	1	2	11,5
0	1	0	0,3	2	1	1	2,0	3	1	3	16,0
0	1	1	0,6	2	1	2	3,0	3	2	0	9,5
0	2	0	0,6	2	2	0	2,0	3	2	1	15,0
1	0	0	0,4	2	2	1	3,0	3	2	2	20,0
1	0	1	0,7	2	2	2	3,5	3	2	3	30,0
1	0	2	1,1	2	2	3	4,0	3	3	0	25,0
1	1	0	0,7	2	3	0	3,0	3	3	1	45,0
1	1	1	1,1	2	3	1	3,5	3	3	2	110,0
1	2	0	1,1	2	3	2	4,0	3	3	3	>140,0
1	2	1	1,5	3	0	0	2,5				
1	3	0	1,6	3	0	1	4,0				
2	0	0	0,9	3	0	2	6,5				
2	0	1	1,4	3	1	0	4,5				

Adapted from the " Standard Methods for the Examination of Water and Waste Water " (1976)

**COMPENDIUM OF INTERNATIONAL METHODS OF ANALYSIS -
OIV
Microbiological analysis of wines and musts**

Appendix 4

Diluents:

Diluents are indicated by way of example. The water to be used must be distilled, double distilled or deionized, with no traces of metals, inhibitors or other anti-microbial substances.

1. Physiological water

Preparation: Weigh 8.5g of sodium chloride in a 1000 mL calibrated flask. After it has dissolved in the water, adjust the reference volume. Mix thoroughly. Filter. Distribute 9 mL in the test tubes. Stop with carded cotton and autoclave for 20 min at 121°C.

2. Ringer's solution 1/4

Preparation: Weigh 2.250g of sodium chloride, 0.105g of potassium chloride, 0.120g of calcium chloride (CaCl₂·6H₂O) and 0,050g of sodium hydrogen carbonate in a 1000 mL calibrated flask. After it has dissolved in water, make up to the mark. Mix thoroughly. Distribute 9 mL in the test tubes. Stop with carded cotton and autoclave for 15 min at 121°C. (This solution is available commercially)

3. Peptone water

Preparation: Weigh 1g of peptone in a 1000 mL calibrated flask. After it has dissolved in the water, adjust the reference volume. Mix thoroughly. Distribute 9 mL in the test tubes. Stop with carded cotton and autoclave for 20 min at 121°C.

**COMPENDIUM OF INTERNATIONAL METHODS OF ANALYSIS -
OIV
Microbiological analysis of wines and musts**

Appendix 5

Culture media

Culture media and antimicrobials are indicated by way of example.
The water to be used must be distilled, double distilled or deionized with no traces of metals, inhibitors or other antimicrobial substances.

1. Solid culture media

If not otherwise stated, pH of all media should be adjusted to pH 5.5 -6.0

1 MEDIA FOR YEAST COUNT

1.1 YM

Glucose	50 g
Peptone	5 g
Yeast extract	3 g
Malt extract	3 g
Agar-agar	20 g
Water: up to	1000 ml

If necessary add 100 mg chloramphenicol to suppress bacterial growth and 150 mg biphenyl to suppress mould growth.

1.2 YEPD

Glucose	20 g
Peptone	20 g
Yeast extract	10 g
Agar-agar	20 g
Water: up to	1000 ml

If necessary add 100 mg chloramphenicol to suppress bacterial growth and 150 mg biphenyl to suppress mould growth.

1.3 WL Nutrient Agar

Glucose	50 g
Peptone	5 g
Yeast extract	4 g
Potassium phosphate monobasic (KH ₂ PO ₄)	0.55 g
Potassium chloride (KCl)	0.425 g
Calcium chloride (CaCl ₂)	0.125 g
Magnesium sulphate (MgSO ₄)	0.125 g
Ferric chloride (FeCl ₃)	0.0025 g
Manganese sulphite (MnSO ₄)	0.0025 g

**COMPENDIUM OF INTERNATIONAL METHODS OF ANALYSIS -
OIV**

Microbiological analysis of wines and musts

Bromcresol green	0.022 g
Agar bacteriological	12 g
Water: up to	1000 ml
pH	5.5

WL Differential agar is made by adding 4 mg/l cycloheximide to WL Nutrient Agar.

If necessary add 100 mg chloramphenicol to suppress bacterial growth.

1.4 Lysine Agar ASBC

Solution A:

Yeast Carbon Base	2.35 g
Water: up to	100 ml

Sterilize by membrane filtration.

Solution B:

Lysine-HCl	0.5 g
Agar agar	4 g
Water: up to	100 ml

Sterilize in 20 min. at 121 °C.

If necessary add 100 mg chloramphenicol to suppress bacterial growth.

2 MEDIA FOR LACTIC ACID BACTERIA COUNT

2.1 M.R.S. + tomato (or apple) juice.

Glucose	20 g
Peptone	10 g
Beef extract	8 g
Yeast extract	4 g
Potassium phosphate, dibasic (KH ₂ PO ₄)	2 g
Sodium acetate · 3H ₂ O	5 g
Ammonium citrate	2 g
Magnesium sulphate · 6H ₂ O	0.2 g
Manganese sulphate · 4H ₂ O	0.05 g
"Tween 80"	1 ml
Agar agar	12 g
Tomato (or apple, or grape) juice	200 ml
Water up to	1000 ml

Add 100mg / L natamycin (pimaricin) to inhibit the growth of yeasts, after autoclaving, just before use.

**COMPENDIUM OF INTERNATIONAL METHODS OF ANALYSIS -
OIV**

Microbiological analysis of wines and musts

2.2 Tomato Juice Agar

Tomato juice (dry extract from 400 ml)	20 g
Peptone	10 g
Peptonized milk	10 g
Agar-agar	14 g
Water	1000 ml
pH	6.1

Add 100mg / L natamycin (pimaricin) to inhibit the growth of yeasts, after autoclaving, just before use.

2.3 Modified ATB medium, or *Oenococcus oeni* medium (formerly *Leuconostoc oenos* medium).

Solution A:

Glucose	10 g	
Yeast extract	5 g	
Peptone	10 g	
Magnesium sulphate	0.2 g	
Manganese sulphate	0.050 g	
Tomato juice (or apple juice or grape juice)		250 ml
Agar agar	12 g	
Water	750 ml	

Sterilize by autoclaving 20 min. at 121°C.

Solution B:

Cysteine HCl	1 g
Water: up to	100 ml
pH	4.8

Sterilize by membrane filtration.

Add 100mg / L natamycin (pimaricin) to inhibit the growth of yeasts, just before use.

Add 1 ml of solution B to 20 ml of solution A at the moment of use

2.4 Lafon-Lafourcade medium

Glucose	20 g
Yeast extract	5 g
Beef extract	10 g
Peptone	10 g
Sodium acetate	5 g
Tri-ammonium citrate	2 g
Magnesium sulphate · 6H ₂ O	0.2 g

**COMPENDIUM OF INTERNATIONAL METHODS OF ANALYSIS -
OIV**

Microbiological analysis of wines and musts

Manganese sulphate · 4H ₂ O	0.05 g
"Tween 80"	1 ml
Agar-agar	20 g
Water: up to	1000 ml
pH	5.4

Add 100mg / L natamycin (pimaricin) to inhibit the growth of yeasts, after autoclaving, just before use.

2.5 Dubois medium (Medium 104)

Tomato juice	250 ml
Yeast extract	5 g
Peptone	5 g
Malic acid	3 g
Magnesium sulphate · 6H ₂ O	0.05 g
Manganese sulphate · 4H ₂ O	0.05 g
Agar-agar	20 g
Water: up to	1000 ml
pH	4.8

Add 100mg / L natamycin (pimaricin) to inhibit the growth of yeasts, after autoclaving, just before use.

2.6 MTb.

Glucose	15 g
Lab-Lemco Powder (Oxoid)	8 g
Hydrolyzed casein	1 g
Yeast extract	5 g
Tomato juice	20 ml
Sodium acetate	3 g
Ammonium citrate	2 g
Malic acid	6 g
Magnesium sulphate	0.2 g
Manganese sulphate	0.035 g
"Tween 80"	1 mg
TC Vitamins Minimal Eagle, 100x (BD-Difco)	10 ml*
pH (con KOH)	5.0
Water up to	1000 ml

* add after sterilization.

Add 100mg / L natamycin (pimaricin) to inhibit the growth of yeasts, after autoclaving, just before use.

**COMPENDIUM OF INTERNATIONAL METHODS OF ANALYSIS -
OIV**

Microbiological analysis of wines and musts

3 MEDIA FOR ACETIC ACID BACTERIA COUNT

3.1 GYC

Glucose		50 g
Yeast extract	10 g	
Calcium carbonate (CaCO ₃)	30 g	
Agar	25 g	
Water: up to	1000 ml	

Add 100mg / L natamycin (pimaricin) to inhibit the growth of yeasts, and 12.5 mg/L of penicillin to eradicate the growth of lactic acid bacteria, after autoclaving, just before use.

3.2 Medium G2

Yeast extract	1.2 g
Ammonium phosphate	2 g
Apple juice	500 ml
Agar	20 g
Water: up to	1000 ml
pH	5.0

Add 100mg / L natamycin (pimaricin) to inhibit the growth of yeasts, and 12.5 mg/L of penicillin to eradicate the growth of lactic acid bacteria after autoclaving, just before use.

3.3 Kneifel medium

Yeast extract	30 g
Ethanol	20 ml*
Agar	20 g
Bromocresol green 2.2%	1mL
Water: up to	1000 ml

* to be added after sterilization.

Add 100mg / L natamycin (pimaricin) to inhibit the growth of yeasts, and 12.5 mg/L of penicillin to eradicate the growth of lactic acid bacteria after autoclaving, just before use.

Blue colonies: *Acetobacter*, *Gluconacetobacter*

Green colonies: *Gluconobacter*

4 MEDIA FOR MOULD COUNT

4.1 Czapek-Dox, Modified

**COMPENDIUM OF INTERNATIONAL METHODS OF ANALYSIS -
OIV**

Microbiological analysis of wines and musts

Sucrose	30 g
NaNO ₃	3 g
K ₂ HPO ₄	1 g
MgSO ₄	0.5 g
KCl	0.5 g
FeSO ₄	0.01g
Agar	15 g
Final pH (at 25°C)	7.3 ± 0.2

Add 10 mg/l cycloheximide to suppress yeast growth (cycloheximide-resistant yeast growth is usually slower than mould growth).

Note: This medium allows the growth only of nitrate-growing moulds.

Add tetracycline (100 mg/l) and streptomycin (100 mg/l) to suppress growth of bacteria.

4.2 Dichloran Rose Bengal Chloramphenicol Agar (DRBC Agar)

Glucose	10 g
Peptone	5 g
KH ₂ PO ₄	1 g
MgSO ₄	0.5 g
Rose Bengal	0.025 g
Dichloran (2,6 dichloro-4-nitroaniline)	0.002g
Chloramphenicol solution (0.1 g/10ml)*	10 ml
Agar	15 g
Final pH (at 25°C)	5.6 ± 0.2

* To be added after sterilization.

4.3 Malt Extract Agar (MEA)

Glucose	20 g
Malt extract	20 g
Peptone	5 g
Agar	15 g
Final pH (at 25°C)	5.5 ± 0.2

Add tetracycline (100 mg/l) and streptomycin (100 mg/l) to suppress growth of bacteria.

2. Liquid culture media

2.1. For yeasts

**COMPENDIUM OF INTERNATIONAL METHODS OF ANALYSIS -
OIV**

Microbiological analysis of wines and musts

YEPD medium (Yeast Extract, Peptone, Dextrose) + chloramphenicol

Preparation: Weigh 10.0g of yeast extract (Difco or equivalent), 20g of peptone, 20g of glucose and 100 mg of chloramphenicol. Dissolve, make up to 1000 mL volume with water and mix.

Distribute 5 mL portions of this medium in the test tubes and autoclave for 15 minutes at 121°C.

2.2. For lactic bacteria

MTJ medium (50% MRS medium "Lactobacilli Man Rogosa and Sharpe Broth" + 50% TJB medium "Tomato Juice Broth") + actidione

Preparation: Weigh 27.5g of MRS "Lactobacilli Man Rogosa and Sharpe Broth" (Difco or equivalent). Add 500 mL of water, heat to boiling to permit complete dissolution and add 20.5g of TJB "Tomato Juice Broth" (Difco or equivalent). Add 50g of actidione. Dissolve with water in order to obtain 1000 mL of solution having first corrected the pH to 5 with 1N hydrochloric acid and mix.

Distribute 10 mL portions of this medium³⁾ in the tubes and autoclave for 15 minutes at 121°C.

³⁾ The 10 mL volume is used instead of the 5 mL volume as with yeasts, due to the greater sensitivity of lactic bacteria to oxygen.

APPENDIX 6: RECOGNITION OF SPECIFIC MICROORGANISMS

6.1 Yeast colony recognition on WL Nutrient Agar.

The use of this medium does not want to be a method to identify species, but can offer to non-specialized laboratories a quick and cheap way to predict the genus of viable and culturable yeasts. After 4-days incubation evaluate the colony morphology as follows (Pallman, C., J. B. Brown, T. L. Olineka, L. Cocolin, D. A. Mills and L. F. Bisson. 2001. Use of WL medium to profile native flora fermentations. *American Journal of Enology and Viticulture* 52:198-203; A. Cavazza, M. S. Grando, C. Zini, 1992. Rilevazione della flora microbica di mosti e vini. *Vignevini*, 9-1992 17-20):

- ***Saccharomyces* spp.:** Colonies grow well in 4 days on WL Nutrient Agar giving circular cream-coloured to pale greenish colonies. Different colour shades do not necessary indicate the presence of different strains, but the presence of petite mutants; colonies are umbonated, smooth and dull surface, the consistency is butyrous. It doesn't grow on Lysine Agar.

- ***Torulaspota* spp.:** the colonies are similar to those of *Saccharomyces* spp. It grows on Lysine Agar.

- ***Hanseniaspora* spp. (*Kloeckera* spp.)** Grows on WL Nutrient Agar in 4 days, giving deep green flat, smooth and butyrous colonies. It grows on Lysine Agar and on WL Differential Agar.

- ***Candida stellata*** Grows on WL Nutrient Agar in 4 days, giving pea-green, smooth and butyrous colonies, becoming darker in the centre with the age. It grows on Lysine Agar.

- ***Saccharomycodes* spp.** Grows on WL Nutrient Agar in 4 days, giving light green, smooth and butyrous convex colonies. It grows on Lysine Agar, not on WL differential agar.

Note: its cells, viewed under the microscope, are very large (up to 25 µm).

- ***Schizosaccharomyces pombe*** Grows on WL Nutrient Agar in 4 days, giving deep green pinpoint size, smooth colonies. It grows on Lysine Agar.

Note: its cells, under the microscope are easily recognised because of typical scission division.

- ***Rhodotorula* spp.** Grows on WL Nutrient Agar in 4 days, giving deep pink, smooth and mucous surface and butyrous colonies. It grows on Lysine Agar.

- ***Metschnikowia* spp.** Grows on WL Nutrient Agar in 4 days, giving clear, smooth and butyrous little colonies. A reddish pigment diffuses in the medium below the colonies. It grows on Lysine Agar.

- ***Pichia membranifaciens*** Grows on WL Nutrient Agar in 4 days, giving greyish- or bluish-shaded rough and powdery convex colonies. It grows on Lysine Agar.

**COMPENDIUM OF INTERNATIONAL METHODS OF ANALYSIS -
OIV**

Microbiological analysis of wines and musts

- ***Pichia anomala*** (formerly *Hansenula anomala*) grows on WL Nutrient Agar in 4 days, giving cream-colored or bluish colonies, distinctly bluish after 8 days. Colonies are circular, the surface is smooth and the consistency is butyrous, but sometimes clearly mucous. It grows on Lysine Agar.

- ***Dekkera spp.* or *Brettanomyces spp.*** Grows on WL Nutrient Agar in 8 days, giving small dome-shaped, cream-coloured, smooth and butyrous colonies. It produces high amounts of acetic acid, clearly perceivable by smell that turns the medium to yellow. It grows on Lysine Agar and on WL Differential Agar. The growth on this last medium makes it possible to distinguish it from *Zygosaccharomyces bailii*.

Note: a confirmation is possible with microscopical examination: Dekkera has small cells, some of them have a typical ogival shape.

- ***Zygosaccharomyces bailii*** Grows on WL Nutrient Agar in 4 days, giving small circular cream-coloured, smooth and butyrous colonies. It grows on Lysine Agar but not on WL Differential Agar. A yellowish halo is often present around young colonies.

Note: when grown on bottled wine it produces brown 0,5-1 mm clusters. Its cells do not have ogival shape.

- **Acetic acid bacteria** grow on WL Nutrient Agar with small to pinpoint-size deeply green and brilliant colonies that are strongly positive to catalase test. (*Note – This medium is not suitable for their count*).

- **Lactic Acid Bacteria** grow on WL Nutrient Agar in 10 days with pinpoint size clear catalase-negative colonies. (*Note – This medium is not suitable for their count*).

6.2 Lactic Acid Bacteria colony recognition.

LAB colonies are translucent and range in size from a pinpoint to a few mm in diameter. They are gram-positive and catalase-negative. *Oenococcus oeni* grow in short chains, pediococci form tetrads and diplococci, lactobacilli form long or short bacilli.

6.3 Acetic Acid Bacteria colony recognition.

AAB colonies are catalase positive and gram-negative, and are strong acid-producers: this can be seen by a clear zone around their colonies in media containing calcium carbonate or by a different colour if the medium contains a pH indicator. Their cells are cocci or bacilli, generally a little larger than LAB.

Method OIV-MA-AS4-02A

Type IV method

Detection of preservatives and fermentation inhibitors

Method A 35

modified by resolution OENO 6/2006

OIV/OENO 377/2009

1. Fermentability Test

1.1 Objective

To show without specifying their nature, the possible presence of one or several substances which act as fermentation inhibitors in wine.

1.2 Principle

The wine, whose free sulfur dioxide has been bound by addition of an aqueous solution of acetaldehyde, is brought to 10% (v/v) alcohol. Glucose is added in order for the sugar concentration to be between 20 and 50 g/L in the nutrient solutions.

After inoculation with a yeast strain resistant to alcohol, the fermentation is followed by weighing the quantity of carbon dioxide released.

The fermentation rate is compared to that of an authentic natural wine similar in make up to the wine analyzed, and also to that of the test wine whose pH has been adjusted to 6 (the majority of the mineral and organic acids are not active in fermentation at this pH). These two reference wines are inoculated in the same manner as the test wine.

1.3 Apparatus

90 mL flask sealed with a rubber stopper with a hole into which is placed a narrow tube tapered at the uppermost portion.

1.4 Reagents and media

1.4.1 Aqueous acetaldehyde solution:

Solution prepared from acetaldehyde obtained by distillation of metaldehyde or paraldehyde, in the presence of sulfuric acid, and standardized by the method using sodium sulfite. Adjust the concentration of the solution to 6.9 g/L.

COMPENDIUM OF INTERNATIONAL METHODS OF ANALYSIS-OIV
Detection of preservatives and fermentation inhibitors

1 mL of this solution fixes 10 mg of sulfur dioxide.

1.4.2 Nutrient Solutions:

- Ammonium Sulfate, (NH₄)₂ SO₄ 25 g/L
- Asparagine 20 g/L

These solutions must be stored in the refrigerator.

1.4.3 Culture Medium:

- Solid medium: malt agar.

Powdered malt3 g
Glucose	10 g
Pancreatic peptone	5 g
Powdered yeast extract	3 g
Agar	20 g
Water	1 L
pH	6

Sterilize for 20 min. at 118 °C.

This mixture exists in a commercial prepared form.

- Liquid medium (an option):

- Divide the grape juice containing 170 to 200 g/L of sugar, in tubes stoppered with cotton, at a rate of 10 mL per tube; sterilize in a water bath at 100 °C for 15 min.
- Liquid malt: same medium as the solid medium, but without agar.

1.4.4 Culture and maintenance of the *Saccharomyces bayanus* strain and preparation of the yeast.

a) Culture and maintenance of the strain on solid medium: From a collection strain, inoculate in lines (streak) onto tubes of solid medium. These tubes are put in an incubator at 25°C until the culture is very visible (about 3 days); the tubes can be stored in the refrigerator. This is sufficient for 6 months.

b) Preparation of the yeast:

One of the tubes of the liquid medium is inoculated in accordance with proper microbiological techniques from the strain cultivated on solid medium; after growth (24 to 48 h), repeat 2 times successively into the same medium enriched with 10% alcohol (v/v), to acclimate the strain.

The second culture when actively fermenting will contain about 50 million yeast per milliliter. This culture will serve to inoculate the wine to be studied. Perform a count and inoculate at a rate of 10⁵ yeast/mL.

1.5 Procedure

- Preparation of the wine:

COMPENDIUM OF INTERNATIONAL METHODS OF ANALYSIS-OIV
Detection of preservatives and fermentation inhibitors

100 mL of wine is treated with the necessary quantity of acetaldehyde calculated in accordance with the amount of free sulfur dioxide (44 mg of aldehyde binds 64 mg of sulfur dioxide). Wait 24 hours and check that the wine contains less 20 mg free sulfur dioxide per liter.

If the alcoholic strength is greater than 10% (v/v), the wine should be diluted with one of the solutions of glucose and water in amounts calculated to result in a sugar concentration between 20 and 50 g/L, and to reduce the strength to about 10% (v/v). For wines containing less than 10% vol., add solid glucose to bring without dilution the amount of sugar between these values, so the fermentation rate is not altered by the amount of sugar.

- Fermentability test:

In a 90 mL flask, place 60 mL of wine prepared as above, 2.4 mL of ammonium sulfate solution and 2.4 mL of asparagine solution. Inoculate with 3 drops of a 3 day old culture of *Saccharomyces bayanus*, to obtain an initial population close to 10^5 yeast/mL. Install the stopper with the pointed tube, weigh the assembly to the nearest 10 mg and place in an oven at 25°C.

Weigh daily for at least 8 days.

Run each time concurrently, a wine of comparable make up and origin which does not contain any preservative along with the test wine which has been adjusted to pH 6.

A flask of non-inoculated wine indicates loss by evaporation.

1.6 Interpretation

In most cases, the fermentation begins within 48 hours and the daily liberation of gas is greatest between the 3rd and the 5th day.

One can confirm the presence of a fermentation inhibitor only in the following conditions:

- a) If the fermentation does not begin or is delayed at least 2 days compared to one of the 2 controls. When the delay is brief, it is difficult to ascertain the presence because there may be "false positive" results, since certain natural sweet wines sometimes behave as if they contained traces of inhibitors (in particular sweet wines made from grapes having noble rot).
- b) If the maximum daily release has not taken place between the 3rd and 5th day, but after the 7th day, this release must be greater than or equal to 50 mg for 60 mL of wine.
- c) Plotting the fermentation curve and the curve of daily release of CO₂ as a function of time can facilitate the interpretation in a difficult case.

Method OIV-MA-AS4-02B

Type IV method

Detection of preservatives and fermentation inhibitors

Method A 35

modified by resolution OENO 6/2006

OIV/OENO 377/2009

1. Detection of the following acids: sorbic, benzoic, *p*-chlorobenzoic, salicylic, phydroxybenzoic and its esters

1.1 Thin layer chromatography

1.1.1 Principle

The preservatives are extracted with ether from the previously acidified wine. After separation by thin layer chromatography with polyamide powder, they are located and characterized by examining the chromatogram under ultraviolet light.

1.1.2 Apparatus

- Chromatography bath.
- 20 x 20 cm glass plates.

Preparation of the plates - Mix thoroughly 12 g of dry polyamide powder with 0.3 g fluorescent indicator; add, while stirring, 60 mL of methanol; spread on plates to a thickness of 0.3 mm. Dry at normal temperature.

Note: Commercially prepared plates can be used.

1.1.3 Reagents

- Diethyl ether
- Methanol
- Ethanol, 96% (v/v).
- Sulfuric acid diluted to 20% (v/v)
- Anhydrous sodium sulfate
- Polyamide powder for chromatography (e.g., Macherey-Nagel or Merck).
- Fluorescent indicator (F₂₅₄ Merck or equivalent).
- Solvent:
 - n*-Pentane 10 vol.
 - n*-Hexane 10 vol.

COMPENDIUM OF INTERNATIONAL METHODS OF ANALYSIS-OIV
Detection of preservatives and fermentation inhibitors

Glacial acetic acid
3 vol.

– Standard solutions:

- Prepare standard solutions containing 0.1 g/100 mL of 96% ethanol (v/v) of the following acids: sorbic, *p*-chlorobenzoic, salicylic, *p*-hydroxybenzoic and its esters.
- Prepare a solution of 0.2 g benzoic acid per 100 mL of 96% ethanol (v/v).

1.1.4 Procedure

Place 50 mL of wine in a separatory funnel; acidify with dilute 20% sulfuric acid (1.1.3.4), and extract 3 times using 20 mL diethyl ether (1.1.3.1) per extraction. Combine the washed solutions in a separatory funnel and wash with a few milliliters of distilled water. Dry the ether with the anhydrous sodium sulfate (1.1.3.2). Evaporate the ether dry using a 100°C water bath, or a rotary evaporator. If the evaporation is accomplished on a water bath, it is advisable to hasten the evaporation using a mild current of air until 2 or 3 milliliters remain, then finish the evaporation cold.

Dissolve the residue in 1 mL ethanol, deposit 3 to 5 µL of this solution on the polyamide plate, as well as 3 to 5 µL of the various preservative standard alcoholic solutions (1.1.3.9). Place the plate in a chromatography tank, and saturate with solvent vapors. Let the solvent migrate to a height of about 15 cm, which takes from 1.5 to 2.5 hours.

Remove the plate from the tank and allow to dry at normal temperature. Examine in ultraviolet light, at a wavelength of 254 nm. The preservatives appear from the bottom of the plate upward in the following order: *p*-hydroxybenzoic acid, esters of *p*-hydroxybenzoic, salicylic acid, *p*-chlorobenzoic acid, benzoic acid, sorbic acid.

With the exception of salicylic acid, which has a light blue fluorescence, other preservatives give dark spots on a fluorescent yellow-green background.

Sensitivity - This technique allows determination of the following minimum quantities of the miscellaneous preservatives expressed in milligrams per liter:

Salicylic acid		
	3	
Sorbic acid		
	5	
Esters of <i>p</i> -hydroxybenzoic acid		5
<i>p</i> -Hydroxybenzoic acid	5-10	
<i>p</i> -Chlorobenzoic acid	5-10	

Benzoic acid
20

1.2 High performance liquid chromatography

1.2.1 Procedure

The method is performed directly on the wine, without sample preparation. It is necessary to dilute red wines before injecting them in order to preserve the column.

Using this method, the detection threshold of preservatives in the solution analyzed is about 1 mg/L.

1.2.2 Operating conditions

Conditions which are appropriate are the following:

- A. For the determination of sorbic and benzoic acid
Proceed according to the sorbic, benzoic, salicylic acid assay method in wines by high performance liquid chromatography (AS313-20-SOBESA) provided in the Compendium
- B. For the determination of *p*-chlorobenzoic acid, *p*-hydroxybenzoic acid and its esters
Column: see A
Mobile phase:
Solution of ammonium acetate, 0.01 M + methanol (60 : 40)
pH: 4.5 - 4.6
Flow rate: see A
Injected volume: see A
Detector: UV, 254 nm
Temperature: see A

BIBLIOGRAPHY

JUNGE Ch., *Zeits. Unters. Lebensmit.*, 1967, **133**, 319

Detection of preservatives and fermentation inhibitors

Method A 35

modified by resolution OENO 6/2006

OIV/OENO 377/2009

1 Detection of the monohalogen derivatives of acetic acid

1.1 Principle

The monohalogen derivatives of acetic acid are extracted with ether from acidified wine. The ether is then extracted using a 0.5 M sodium hydroxide solution. The extraction solution must have the alkalinity maintained between 0.4 and 0.6 M. After the addition of thiosalicylic acid, the synthesis of the thioindigo is implemented by the following steps:

- a) Condensation of the monohalogen derivative with thiosalicylic acid and formation of *ortho*-carboxylic phenylthioglycolic acid;
- b) Cyclization of the acid formed in a heated alkaline medium, with the formation of thioindoxyl;
- c) Oxidation of the thioindoxyl with potassium ferricyanide in an alkaline medium with formation of thioindigo, soluble in chloroform, in which it gives a red color.

1.2 Apparatus

- Water bath at 100°C.
- Mechanical stirrer.
- Oven with a temperature of $200 \pm 2^\circ\text{C}$.

1.3 Reagents

- Diethyl ether.
- Hydrochloric acid solution diluted to 1/3 (v/v). Mix one part pure hydrochloric acid, $\rho_{20} = 1.19 \text{ g/mL}$, with 2 parts of distilled water.
- Anhydrous sodium sulfate.

COMPENDIUM OF INTERNATIONAL METHODS OF ANALYSIS-OIV
Detection of preservatives and fermentation inhibitors

- Thiosalicylic acid solution: thiosalicylic acid 3 g in 100 mL sodium hydroxide solution, 1.5 M.
- Sodium hydroxide solution, 0.5 M
- Potassium ferricyanide solution containing 2 g of $K_3Fe(CN)_6$ per 100 mL of water.
- Chloroform.

1.4 Procedure

Place 100 mL of test wine in an extraction flask with a ground glass stopper; add 2 mL hydrochloric acid (1.3.2) and 100 mL diethyl ether (1.3.1). Shake the contents vigorously for a few seconds by hand, then for 1 h with a mechanical stirrer (1.2.2). Transfer to a separating funnel, allow to separate and recover the ether layer.

Shake the ether extract with 8 to 10 g of anhydrous sodium sulfate (1.3.3) for a few seconds.

Transfer the extract to the separating funnel, add 10 mL sodium hydroxide solution, 0.5 M (1.3.5); shake for 1 min. Allow to settle.

Remove 0.5 mL of the alkaline extract and check, by titration with sulfuric acid, 0.05 M, so that the strength falls between 0.4 and 0.6 M. Transfer the alkaline extract contained in the separating funnel into a test tube containing 1 mL of thiosalicylic acid solution. Adjust, if necessary the strength of the alkaline extract in order to bring it to the limits indicated, using a stronger sodium hydroxide solution of known strength. Shake the contents of the test tube for 30 seconds and transfer to an evaporating dish.

Place the dish on a water bath at 100°C blowing its surface with a current of cold air. Maintain the dish on the water bath at 100°C for exactly 1 hour; the residue may become practically dry in a shorter amount of time. If a crust forms on the surface of the residue during the evaporation, it is advisable to break or grind it up with a thin glass rod to facilitate the evaporation.

Place the dish in an oven maintained at $200 \pm 2^\circ\text{C}$ for exactly 30 minutes. After cooling, recover the contents of the dish with 4 mL of water; transfer into a separation funnel, add to the dish 3 mL of potassium ferricyanide solution to fully dissolve any remaining residue and add to the separating funnel. Shake for 30 seconds to facilitate oxidation. Add 5 mL chloroform, mix using 3 to 4 inversions. Allow to separate.

A pink or red color (according to the quantity of thioindigo formed) indicates the presence of monohalogen derivatives of acetic acid.

COMPENDIUM OF INTERNATIONAL METHODS OF ANALYSIS-OIV
Detection of preservatives and fermentation inhibitors

Sensitivity - The method allows detection of 1.5 to 2 mg monochloroacetic acid per liter of wine and corresponding quantities of the other derived monohalogenes. Since the yield of miscellaneous extractions is not quantitative, this method cannot be used for determining the amount of these monohalogen derivatives in the wines.

BIBLIOGRAPHY

- FRIEDLANDER, *Ber. Deutsch. Chem. Gesell.*, 1906, **39**, 1062.
RAMSEY L.L., PATTERSON W.I., *J. Ass. Off. Agr. Chem.*, 1951, **34**,
827.
PERONNET M., ROCQUES S., *Ann. Fals. Fraudes*, 1953, 21-23.
Traité de chimie organique, edited by V. Grignard, 1942, **19**, 565-
566.
Official Methods of Analysis of the Association of Official Analytical
Chemists, 11th édition, publiée par l'Association of Official
Analytical Chemists, Washington, 1970, 340-341.
TERCERO C., *F.V., O.I.V.*, 1967, n° 224.

Method OIV-MA-AS4-02D

Type IV method

Detection of preservatives and fermentation inhibitors

Method A 35

modified by resolution OENO 6/2006

OIV/OENO 377/2009

1. Examination and determination of ethyl pyrocarbonate (diethyl dicarbonate)

1.1 *Principle*

The diethyl carbonate formed by degradation of ethyl pyrocarbonate (diethyl ester of pyrocarbonic acid) in the presence of ethanol is extracted from wine using carbon disulfide and the quantity determined by gas chromatography. Either of the procedures described below may be used.

1.2 *Apparatus*

1.2.1 Gas chromatography with flame ionization detector.

1.2.2 Columns:

- Capillary column coated with Carbowax 1540
Column length: 15.24 m
Inside diameter: 0.51 mm
- Polypropyleneglycol on Celite 545 (15:100), 60-100 mesh
Column length: 2 m
Interior diameter: 3 mm

1.3 *Reagents*

1.3.1 Anhydrous sodium sulfate

1.3.2 Carbon disulfide

The carbon disulfide must contain no impurities in the critical retention zone (5 to 7 min.) for maximum sensitivity in accordance with the conditions of gas chromatography as indicated in paragraph 1.4.2.

1.4 *Procedure*

1.4.1 Use of the capillary column.

Place 100 mL wine in a 250 mL separating funnel with 1 mL of carbon disulfide (1.3.2). Mix vigorously for 1 min. The carbon disulfide phase

COMPENDIUM OF INTERNATIONAL METHODS OF ANALYSIS-OIV
Detection of preservatives and fermentation inhibitors

separated is rapidly centrifuged, then dried with anhydrous sodium sulfate (1.3.1).

Inject 10 µl of the clear liquid supernatant into the chromatograph.

Chromatography conditions:

– Detector gases:

hydrogen: 37 mL/min.

air: 250 mL/min.

– Gas flow:

nitrogen: 40 mL/min.

A 1/10 splitter sends to the detector the gas mixture with a flow rate of 3 to 5 mL/min.

– Temperature:

injector: 150 °C;

oven: 80 °C;

detector: 150 °C

– Detection limits:

0.05 mg/L of wine

1.4.2 Use of the column for polypropyleneglycol.

Add 20 mL of wine and 1 mL of carbon disulfide (1.3.2) into a conical centrifuge tube with a stopper. Agitate vigorously for 5 minutes, then centrifuge for 5 minutes applying a centrifugal force of 1000 to 1200 g. The liquid supernatant produced is aspirated by a thin-tipped pipette; the carbon disulfide phase is dried with a small quantity of anhydrous sodium sulfate, added while stirring with a glass rod. Inject 1 µL of the clear liquid into the gas chromatograph.

Chromatography conditions.

– Detector gas:

hydrogen: 35 mL/min.

air: 275 mL/min.

– Carrier gas flow:

nitrogen: 25 mL/min.

– Temperature:

injector: 240 °C

oven: 100 °C

detector: 240 °C

– Sensitivity range:

12 x 10⁻¹¹ A to 3 x 10⁻¹¹ A

– Chart speed:

1 cm/min.

– Detection limit:

0.10 - 0.05 mg/L of wine

COMPENDIUM OF INTERNATIONAL METHODS OF ANALYSIS-OIV
Detection of preservatives and fermentation inhibitors

Under these exact conditions, diethyl carbonate displays a retention time of about 6 min.

The calibration of the apparatus is carried out using solutions of 0.01 and 0.05% (*m/v*) diethyl carbonate in carbon disulfide (1.3.2).

COMPENDIUM OF INTERNATIONAL METHODS OF ANALYSIS-OIV
Detection of preservatives and fermentation inhibitors

1.5 *Calculation*

Quantitative determination of diethyl carbonate is carried out preferably using the internal standard method, referring to the peaks of the *iso*-butyl alcohol or *iso*-amyl alcohol which are close to that of diethyl carbonate.

Prepare two samples of test wine: one of wine with 10 mL 10% ethanol (v/v) added, the other the same wine to which has been added 1 mg diethyl carbonate per liter using 10 mL of a 100 mg/L solution of diethyl carbonate in 10% ethanol (v/v).

Treat these two samples according to one or the other of the techniques above according to the column used.

Let:

S = the peak area of the diethyl carbonate in the spiked wine

S_x = the peak area of the diethyl carbonate in the wine,

i = the peak area of internal standard in the wine,

I = the peak area of internal standard in the spiked wine .

The concentration of diethyl carbonate in mg/L of wine is:

$$\frac{S_x}{S \times \frac{i}{I} - S_x}$$

In the case where standardization is carried out using a pure standard solution of diethyl carbonate, it is necessary to predetermine the yield of the extraction with carbon disulfide in accordance with the procedure utilized. This yield is expressed by the extraction factor F, with a decimal number less than or equal to 1 (yield 100%).

Let:

S_x = the peak area of diethyl carbonate given by the wine,

S_e = the peak area given by the injection of the same volume of a standard solution of diethyl carbonate of concentration C in mg/L,

V_x = the volume of wine used in the extraction with carbon disulfide,

V_s = the volume of carbon disulfide used for the extraction,

E_e = the sensitivity for the recording of S_x,

The concentration of diethyl carbonate in mg/L of wine is:

$$\frac{C \times S_x \times E_x \times V_s}{S_e \times E_e \times F \times V_x}$$

COMPENDIUM OF INTERNATIONAL METHODS OF ANALYSIS-OIV
Detection of preservatives and fermentation inhibitors

If the concentration of the two solutions injected in the chromatograph is similar, the response is the same for the recording of S_x and of S_e ; the formula is simplified and becomes:

$$\frac{C \times S_x \times V_s}{S_e \times F \times V_x}$$

BIBLIOGRAPHY

- KIELHOFER E., WURDIG G., *Dtsch. Lebensmit. Rdsch.*, 1963, **59**, 197-200 & 224-228.
PRILLINGER F., *Weinberg u. Keller*, 1967, **14**, 5-15.
REINHARD C., *Dtsch. Lebensmit. Rdsch.*, 1967, **5**, 151-153.
BANDION F., *Mitt. Klosterneuburg, Rebe u. Wein*, 1969, **19**, 37-39.

Detection of preservatives and fermentation inhibitors

Method A 35

modified by resolution OENO 6/2006

OIV/OENO 377/2009

1. Examination of dehydroacetic acid

1.1 Principle

Wine acidified with sulfuric acid is extracted with a mixture of equal parts of diethyl ether and petroleum ether. After evaporation of the solvent, the extract, recovered with a small quantity of 96% ethanol (v/v) is deposited on a thin layer of polyamide and silica gel with fluorescent indicator and subjected to the action of the mobile solvent (benzene-acetone-acetic acid). The dehydroacetic acid is identified and characterized by ultraviolet examination of the chromatogram.

1.2 Apparatus

- 1.2.1 Equipment for thin layer chromatography
- 1.2.2 Oven
- 1.2.3 Rotary evaporator
- 1.2.4 UV lamp 254 nm.

1.3 Reagents

- 1.3.1 Diethyl ether
- 1.3.2 Petroleum ether (boiling point ≤ 40 °C)
- 1.3.3 Methanol
- 1.3.4 Sulfuric acid, 20% (v/v)
- 1.3.5 Anhydrous sodium sulfate.
- 1.3.6 Ethanol, 96% (v/v) .
- 1.3.7 Chromatographic separation layer: 10 g polyamide powder with fluorescent indicator(e.g. polyamide DC II UV₂₅₄ from Macherey-Nagel) mixed vigorously with 60 mL methanol. Add while stirring, 10 ml of water and 10ml of silica gel (with fluorescent indicator), e.g. Kiesselgel GF₂₅₄ Merck. Spread this mixture on 5 plates (200 x 200 mm) to a thickness of 0.25 mm. Dry the plates at room temperature for 30 minutes, then place in a 70°C oven for 10 min.

COMPENDIUM OF INTERNATIONAL METHODS OF ANALYSIS-OIV
Detection of preservatives and fermentation inhibitors

1.3.8 Migration solvent:

Crystallizable benzene	60
vol.	
Acetone	3 vol.
Crystallizable acetic acid	1
vol.	

1.3.9 Reference solutions:

Dehydroacetic acid and benzoic acid, 0.2%, in alcoholic solution.

Sorbic acid, *p*-chlorobenzoic acid, salicylic acid, *p*-hydroxybenzoic acid and its propyl, methyl and ethyl esters, 0.1 % (*m/v*), in alcoholic solution.

1.4 *Procedure*

Acidify 100 mL of wine using 10 mL of 20% sulfuric acid (1.3.3), then proceed to extract 3 times using 50 mL of a (50:50) diethyl ether-petroleum ether mixture for each extraction. Remove the clear aqueous phase leaving an aqueous emulsion and the ether phase. Mix again the remaining liquid in the separation flask composed of an emulsion and the ether phase. The remaining aqueous phase usually separates clearly from the ether phase. If there is any residual emulsion, it should be eliminated by the addition of a few drops of ethanol.

The diethyl ether-petroleum ether phases recovered are washed with 50 mL water, dried using sodium sulfate, then evaporated by rotary evaporator, at 30 - 35 °C. The residue is recovered with 1 mL of ethanol.

Deposit 20 µL of this solution on the starting line in a 2 cm wide band, or 10 µL in a circular spot. For a comparison standard, deposit 5 µL of each of the reference solutions described above. After the chromatography (ascending height of migration 15 cm, duration 1 hour 15 min. to 1 hour 45 min., at normal saturation of the chamber), the plate is dried at room temperature. Any dehydroacetic acid and other preservatives present show up under a UV lamp at 254 nm.

When the examination of the chromatogram has revealed the presence of *para*-chlorobenzoic acid, the propyl or methyl esters of *para*-hydroxybenzoic acid which are only partly separated by this method may be identified consequently on the extract above, following the method described in *Examination of Sorbic, Benzoic, Parachlorobenzoic Acids, 2.1. Thin layer chromatography*.

BIBLIOGRAPHY

HALLER H.E., JUNGE Ch., *F.V., O.I.V.*, 1972, n° 397, *Mitt. Bl. der Gd CH, Fachgruppe, Lebensmitt. u. gerichtl. Chem.*, 1971, **25**, n° 5, 164-166.

Detection of preservatives and fermentation inhibitors

Method A 35

modified by resolution OENO 6/2006

OIV/OENO 377/2009

6 . Sodium Azide

1.1 Method by high performance liquid chromatography

1.1.1 Principle

Hydrazoic acid isolated in wine using double distillation is identified after derivatization with 3,5-dinitrobenzoyl chloride, by high performance liquid chromatography. Detection is carried out by ultraviolet absorption spectrophotometry at 240 nm.

1.1.2 Apparatus

1.1.2.1 Distillation apparatus (distillation apparatus for determination of alcoholic strength); the end of the condenser terminating in a tampered tube

1.1.2.2 500 mL spherical flasks with ground glass necks

1.1.2.3 10 mL flask with a ground glass stopper

1.1.2.4 Apparatus for HPLC

– Operating conditions:

Column: C₁₈, 25 cm long.

Mobile Phase: acetonitrile-water (50:50)

Flow rate: 1 mL/min.

Volume injected: 20 µL

Detector: ultraviolet absorption spectrophotometer at 240 nm

Temperature: ambient

1.1.3 Reagents

1.1.3.1 Sodium hydroxide, 5% (*m/v*).

1.1.3.2 Sulfuric acid solution, 10% (*m/v*).

1.1.3.3 Indicator reagent: methyl red 100 mg, and methylene blue 50 mg, 100 mL alcohol, 50% (*v/v*).

1.1.3.4 Acetonitrile for chromatography.

COMPENDIUM OF INTERNATIONAL METHODS OF ANALYSIS-OIV
Detection of preservatives and fermentation inhibitors

1.1.3.5 Derivatizing reagent: 3,5-dinitrobenzoyl chloride, 10% (*m/v*), in acetonitrile.

1.1.3.6 Buffer solution of sodium acetate, pH 4.7: mix 1 volume of sodium acetate solution, $\text{NaC}_2\text{H}_3\text{O}_2 \cdot 3\text{H}_2\text{O}$, 1 M, with 1 volume acetic acid solution, 1 M.

1.1.3.7 Sodium azide, NaN_3 .

COMPENDIUM OF INTERNATIONAL METHODS OF ANALYSIS-OIV
Detection of preservatives and fermentation inhibitors

1.1.4 Procedure

1.1.4.1 Preparation of the sample.

Into a spherical flask with a ground glass neck, place 100 mL of wine, distill by plunging the end of the condenser in 10 mL of 5% sodium hydroxide solution (1.1.3), to which are added a few drops of reagent indicator. Distill until 40-50 mL of distillate is recovered.

Transfer the distillate into another spherical flask (1.1.2.2), rinse the flask twice with 20 mL of water and add water to bring to 100 mL. To eliminate the ethanol, attach the flask to the distillation apparatus and eliminate about 50 mL of distillate (reduce the volume by half).

Cool the flask completely. Acidify with 10% sulfuric acid. Distill, recover the distillate into a 10 mL flask with a ground glass stopper containing 1 mL of water, and immerse in an iced bath. Stop the distillation when the total volume reaches 10 mL.

1.1.4.2 Derivatization

Mix 1 mL distillate (1.1.4.1), 0.5 mL of acetonitrile, 0.2 mL buffer solution and 30 μ L of derivatizing reagent and stir vigorously; leave for five minutes.

1.1.4.3 Chromatography

Inject 20 μ L in accordance with the conditions specified, the hydrazoic acid derivative has a retention time of about 11 minutes. Detection limit: 0.01 mg/L.

Note: Sometimes another substance not derivatized can simulate hydrazoic acid. It is necessary to verify a positive result as follows: inject 20 μ L of distillate directly; a disappearance of the peak indicates the presence of hydrazoic acid.

1.1.5 Calculation

To determine the concentration of sodium azide, compare the sample response to that of the standard solution after derivatization. Take into account the concentration factor 10 of the sample of wine at the time of analysis.

1.2 Colorimetric method

1.2.1 Principle

Hydrazoic acid, which is very volatile, is separated by double distillation, permitting the elimination of ethanol, acetic acid and sulfur dioxide. Then the amount is determined colorimetrically after forming a colored complex with ferric chloride (maximum absorbance at 465 nm).

1.2.2 Apparatus

1.2.2.1 Simple distillation apparatus, consisting of a 500 mL flask with a ground glass neck and a condenser ending in a pointed tube

1.2.2.2 Spectrophotometer with optical glass cells 1 cm path length

COMPENDIUM OF INTERNATIONAL METHODS OF ANALYSIS-OIV
Detection of preservatives and fermentation inhibitors

1.2.3 Reagents

1.2.3.1 Sodium hydroxide solution, 1 M

1.2.3.2 Sulfuric acid, 1 M

1.2.3.3 Hydrogen peroxide, 3% (v/v), whose strength must be adjusted just before use using a solution of potassium permanganate, 0.02 M; where p mL equals the volume which oxidizes 1 mL of the hydrogen peroxide solution, 3%

1.2.3.4 Ferric chloride solution at 20 g per liter of Fe III: (weigh 96.6 g of $\text{FeCl}_3 \cdot 6\text{H}_2\text{O}$, or more as this salt is very hygroscopic; control the concentration of Fe III of the solution and adjust if necessary to 20 ± 0.5 g per liter)

1.2.3.5 Stock solution of sodium azide, NaN_3 , at 1 g per liter in distilled water

1.2.3.6 200 mg per liter sodium azide solution prepared by dilution of the solution at 1 g per liter

1.2.4. Procedure

a) Into a 500 mL flask with a ground glass neck, place 200 mL of wine, distill, recover the distillate in a 50 mL volumetric flask, containing 5 mL water, which is immersed in an iced bath. Stop the distillation when the total volume reaches about 50 mL.

b) Transfer quantitatively the distillate into another 500 mL flask with a stopper and rinse the 50 mL flask twice with 20 mL of water.

Neutralize using 1 M sodium hydroxide solution (1.2.3.1) (using pH indicator paper).

Acidify using 10 mL 1 M sulfuric acid (1.2.3.2), mix, then oxidize the sulfur dioxide by adding 3% hydrogen peroxide solution (1.2.3.3.).

If the wine contains S mg per liter of sulfur dioxide, and if p mL is the volume of 0.02 M potassium permanganate solution necessary to oxidize 1 mL of 3% hydrogen peroxide solution, then for 200 mL of wine use the following calculation:

$$\frac{S}{5 \times 3.2p} = \frac{S}{16p} \text{ mL of H}_2\text{O}_2 \text{ solution}$$

Bring the volume to about 200 mL by addition of distilled water.

Distill, recover the distillate in a 50 mL glass flask containing 5 mL distilled water, which is immersed in an ice bath; stop the distillation before the measurement line, bring back to ambient temperature and adjust the volume to 50 mL.

COMPENDIUM OF INTERNATIONAL METHODS OF ANALYSIS-OIV
Detection of preservatives and fermentation inhibitors

- c) Add 0.5 mL (measured exactly) of ferric chloride solution, mix and measure immediately (maximum delay 5 min.) the absorbance at 465 nm in a 1 cm cell; the zero of the apparatus is set using a blank composed of 50 mL of water added to 0.5 mL of ferric chloride solution.
- d) Preparation of the standard curve.
Into each of five 50 mL volumetric flasks add 1, 2, 3, 4, and 5 mL of 200 mg/L sodium azide solution respectively, bring the volume to 50 mL with distilled water, add 0.5 mL of ferric chloride solution and measure the absorbance at 465 nm.
These solutions contain 4, 8, 12, 16, 20 mg of sodium azide per liter. The corresponding concentrations are 1, 2, 3, 4, and 5 mg per liter of wine.
The typical curve of absorbance variation as a function of concentration is a straight line passing through the origin.

1.2.5 Calculation

Plot the absorbance read for the sample analyzed on the straight line and interpolate the concentration of sodium azide in mg/L of wine.

BIBLIOGRAPHY

HPLC method:

SEARIN S.J. & WALDO R.A., *J. Liquid. Chrom.*, 1982, **5**(4), 597-604.

BATTAGLIA R. & MITISKA J., *Z. Lebensm. Unters. Forsch.*, 1986, **182**, 501-502.

Colorimetric method:

CLERMONT S. & CHRETIEN D., *F.V., O.I.V.*, 1977, n° 627.

Enumerating yeasts of the species *Brettanomyces bruxellensis*
using qPCR

(OIV-OENO 414-2011)

Warning to users

Phenol: All handling procedures involving phenol must be performed under a fume hood and gloves must be worn. All phenol-contaminated residues must be collected in suitable containers.

SYBR Green: This displays a non-zero mutagenicity, but one which is lower than that of ethidium bromide. The precautions for use must nevertheless be adhered to.

1. Scope of application

This protocol describes a method for enumerating yeasts of the species *Brettanomyces bruxellensis* in wine in bulk or bottled wines, using real-time qPCR (quantitative polymerase chain reaction) (qPCR). The analysis of wines during AF (alcoholic fermentation) and of musts has not yet been validated.

2. Definition

The micro-organisms enumerated by this method are *Brettanomyces bruxellensis* yeasts which have a copy of the target gene

3. Principle

The PCR technique amplifies, by multiple repetition of an enzymatic reaction, a target DNA (deoxyribonucleic acid) region identified by two primers. The process involves repeating a three-step cycle:

- Denaturing the DNA by heating
- Hybridization of the primers
- Polymerization, carried out by the *Taq* (*Thermophilus aquaticus*) polymerase

However, unlike traditional PCR, qPCR can quantify the DNA amplified during the amplification process through the use of a fluorophore.

COMPENDIUM OF INTERNATIONAL ANALYSIS OF METHODS – OIV
Enumerating yeasts of the species *Brettanomyces bruxellensis*
using qPCR

Until now two regions specific to the species have been used as targets. One region is the encoding gene for the 26S ribosomal RNA (ribonucleic acid) and the other the *RAD4* gene [2, 3]. As with the FISH method, PCR is specific to *Brettanomyces bruxellensis* but has the advantage of being less expensive.

The distinctive feature of qPCR is that it is possible to read, after each amplification cycle, the fluorescence which increases exponentially as the DNA amplification proceeds. Many fluorescence techniques have been developed for this application. The SYBR® Green fluorophore has been found to be suitable for use with *Brettanomyces*.

❖ SYBR® Green fluorophore

This agent fluoresces strongly when it inserts itself non-specifically between the nucleotides in the double-stranded DNA. In contrast, it fluoresces only weakly when unbound. Using this technology, a merged curve can be generated at the end of the amplification that validates the specificity of the reaction.

❖ Internal standard

In order to validate the DNA extraction and amplification stages, an internal standard has been integrated into the method (Lip4 *Yarrowia lipolytica*).

4. Reagents and products

All plastic consumables must be autoclaved beforehand to destroy any DNases (deoxyribonucleases), as must the Tris-HCl and TE (Tris EDTA, ethylene diamine tetra-acetic acid) buffer solutions, the ammonium acetate and the ultrapure water (18 MΩ). All the aqueous solutions are prepared using ultrapure water (18 MΩ). Some solutions are sterilized in an autoclave (indicated as "autoclaved"). Sterile ultrapure water (18 MΩ) is used, if possible, to prepare any solutions which are not autoclaved. It is not then necessary to work under sterile conditions.

- **PVPP** (eg: ISP Polyclar Super R or Sigma P6755-100G),
- **Solutions at room temperature:** Tris-HCl buffer, 10mM pH8, solution I (Tris-HCl 10mM pH8, EDTA 1mM, NaCl 100mM, SDS 1% (sodium

**COMPENDIUM OF INTERNATIONAL ANALYSIS OF METHODS – OIV
Enumerating yeasts of the species *Brettanomyces bruxellensis*
using qPCR**

dodecyl sulfate), Triton X-100 2%), TE (Tris-HCl 10 mM pH8, EDTA 1mM) autoclaved, 4M ammonium acetate, absolute ethanol,

- Provide **one autoclaved, sterilized ultrapure (18 M Ω) water bottle** (20mL) per qPCR plate,
- **Solutions at 4°C**: saturated phenol pH8: chloroform: IAA (isoamyl alcohol 24:25:1) and Rnase (ribonuclease) 1 μ g/ μ L
- **Suspension at -20°C**: internal standard, SYBR Green (e.g. iQ SBYR Green Supermix Bio-Rad 170-8884), primers 4 μ M Brett rad3, Brett rad4, YAL-F and YAL-R each one.
- **Dry bath, set to 37°C.**

All handling procedures involving phenol must be performed under a fume hood and gloves must be worn. All phenol-contaminated residues must be collected in suitable containers.

<u>PCR substances</u>	<u>Specifications</u>	<u>CAS Number</u>
4.1 ammonium acetate	>98%	631-61-8
4.2 phenol:chloroform:IAA (24:25:1)	Ultra	136112-00-0
4.3 proteinase K	1215 U/mg proteins (16.6 ng/ml)	39450-01-6
4.4 SDS	>99% Ultra	151-21-3
4.5 Tris base	>99.8% Ultra	77-86-1
4.6 BSA	Molecular biology grade	9048-46-8
4.7 saturated phenol pH 8		108-95-2
4.8 PVPP 360kDa		9003-39-8
4.9 RNase A	70 U/mg in solution	9001-99-4
4.10 TE pH8	Ultra	Tris : 77-86-1 EDTA : 60-00-4
4.11 Primers 25nmol		-

5. Apparatus

- **Plastic consumables:** 2mL screw-capped microtubes, 1.5 and 1.7mL microtubes, white (10 µL), yellow (200 µL) and blue (1000 µL) pipette tips for micropipettes P20, P200, P1000, P5000, 96-well PCR microplates and optical film, non-powdered gloves
- **Glass beads** (Ø 500 µm)
- **Bottle** (20mL) autoclaved (for ultrapure [18 MΩ] sterilized water, one per qPCR plate),
- 15 and 50 mL **Centrifuge tubes**
- **Equipment:**
 - automatic pipettes (P20, P200, P1000, P5000)
 - microtube centrifuge
 - automatic stirrer to split cells (eg. GenieDisruptor)
 - Thermocycler coupled to a spectrofluorimeter (optical system to detect the fluorescence generated during the real-time PCR reactions)
 - Magnetic stirrer
 - Stop watch
 - dry bath set to 37°C
 - autoclave
 - 100mL volumetric flasks
 - 50mL volumetric flasks
 - 10mL volumetric flasks
 - 100mL beakers
 - 50mL beakers
 - 10mL beakers
 - Magnetic stirring bars

6. Sampling (sample preparation)

6.1. Enumerating the samples:

The samples are removed either directly into bottles for analysis or into pre-sterilized sample flasks.

No interference with the method has been observed from the yeasts tested (including K1 and L2056) when the yeast populations are not greater than 5.10^6 CFU/mL (colony forming units). There is no data for populations larger than this figure; consequently, avoid measuring wines during AF.

NB: When enumerating yeasts using standard microbiology methods of analysis (growth in agar growth medium, optical density), the results are expressed in CFU/mL (colony forming unit). Conversely, enumeration resulting from the analysis by qPCR is expressed in GU/mL (genetic unit).

6.2. Preparing the internal standard

Grow *Yarrowia* in liquid YPD (yeast peptone dextrose) at 28°C up to an OD₆₀₀ (optical density at 600 nm) of 1 (approximately 48 hrs).

After estimating the OD_{600 nm} dilute to 1.0×10^6 CFU/mL in isotonic saline solution ($1 \text{ OD} = 1.0 \times 10^7$ CFU/mL).

Transfer a 110µL sample of the 1.0×10^6 CFU/mL culture into a 1.7mL microtube and add 110µL of 40 % glycerol to obtain a population of 5.0×10^5 CFU/mL. Mix and store at -80°C. One tube can be used to process 5 wine samples.

Perform an enumeration simultaneously to check the titer of the suspension.

6.3. Preparing the solutions

100mL of Tris-HCl pH8 10 mM: weigh 0.121 g of tris base (eg. Trizma base) and dissolve in 80mL of ultrapure [18 MΩ] water. Adjust the pH using HCl. Make up to 100mL. Autoclave.

100mL TE: weigh 0.121 g of tris base and dissolve in 80mL of water. Adjust the pH using HCl. Add 37.2 mg of EDTA. Adjust the pH to 8 (to assist the dissolution of the EDTA) then make up to 100mL. Autoclave.

COMPENDIUM OF INTERNATIONAL ANALYSIS OF METHODS – OIV
Enumerating yeasts of the species *Brettanomyces bruxellensis*
using qPCR

100mL solution I: prepare 50mL of TE 2x and add 10mL of 1M NaCl, 10mL of SDS 10% (dissolved by heating gently) and 2 g of Triton X100, then make up to volume.

4M ammonium acetate: dissolve 15.4 g of ammonium acetate in 50 mL ultrapure [18 MΩ] water qs to 50mL.

100mL phenol:chloroform:IAA (25:24:1): add 48mL of chloroform and 2mL of isoamyl alcohol to 50mL of phenol saturated with TE buffer pH8. Store at 4°C.

RNase A 1µg/µL: dilute a 70U/mg solution of RNase A (e.g. Sigma, R4642-50MG, stored at -20°C) with ultrapure [18 MΩ] water. The specified concentration of the RNase stock is indicated on the tube and in the specification sheet for the batch. The diluted solution should be kept at not more than 4°C for up to 3 weeks.

Brett 4µM primers: using 100 µM stock solutions of primers (in the supplier's tubes), mix 4 µM Brett rad3 (GTTACACAATCCCCTCGATCAAC) and 4 µM Brett rad4 (TGCCAACTGCCGAATGTTCTC) qs to 1mL with ultrapure [18 MΩ] water). Store for up to 1 year at -20°C.

YAL 4µM primers: using 100 µM stock solutions of primers (in the supplier's tubes), mix 4 µM YAL-F (ACGCATCTGATCCCTACCAAGG) and 4 µM YAL-R (CATCCTGTGCTCTTCCAGGTT) qs to 1mL with ultrapure [18 MΩ] water). Store for up to 1 year at -20°C.

7. Procedure

Sample to be analyzed: shake the bottle to homogenize its contents.

For a corked bottle: disinfect the neck of the bottle with 70% alcohol and uncork over a naked flame, using a corkscrew disinfected with 70% alcohol.

Transfer a 15-20mL sample of the wine into a 30-mL, sterile, plastic, single-use bottle.

The steps at which the protocol may be paused are identified by a * (max. interruption time, T°).

7.1. Separating the cells

This step must be duplicated.

The handling procedures must be carried out under a confined microbiological safety cabinet dedicated to this purpose.

- take a **1mL sample of wine** and transfer to a 2mL screw-capped microtube
- add 20µL of internal standard, at a concentration of 5.0×10^5 CFU/mL
- centrifuge for **30 sec. at 9,300g**
- eliminate the supernatant by gently inverting the microtube
- suspend the pellet in **1mL of Tris-HCl 10 mM pH 8**
- centrifuge for **30 sec. at 9,300g** and eliminate the supernatant.
- vortex briefly to suspend the pellet in the residual fluid * (3 months, -20°C).
-

One tube will be used for extracting the DNA and the other will be stored at -20°C until validated results have been obtained.

7.2. Extracting the DNA

From a fresh or frozen pellet. Do not process more than 24 samples at the same time.

- add **PVPP** (1% of final mass/volume) by weighing add **0.3 g** of **200-500µm glass beads**
- add **200µL of solution I**
- add **200µL of phenol:chloroform:IAA (24:25:1)**
- disrupt the cells with the automatic stirrer (for example a **GenieDisruptor**) **4x80 sec.** with cold intervals (-20°C refrigerated unit) lasting for about 80sec between each disruption phase
- add **200µL of TE**
- centrifuge for **5min at 15700g.**
- **carefully** collect 400µL of the upper aqueous phase in a 1.7mL microtube. **If the two phases mix, repeat the centrifugation step.**
- add **1mL of absolute ethanol** and mix the tube by inversion 4-5 times * (a few hours, room T°)
- centrifuge for **5 minutes at 15700g** and eliminate the supernatant by inverting the microtube
- suspend the pellet in **400µL of TE and 30µL of RNase at a concentration of 1 µg/µL**
- incubate the solution at **37°C for 5 minutes (then readjust to 48°C)**
- add **10µL of 4M ammonium acetate + 1mL of absolute ethanol**; mix by inversion
- centrifuge for **5 minutes at 15700g**

COMPENDIUM OF INTERNATIONAL ANALYSIS OF METHODS – OIV
Enumerating yeasts of the species *Brettanomyces bruxellensis*
using qPCR

- eliminate the supernatant by inversion; use filterpaper to absorb the final drops
- dry the pellet (leave the open tube in the dry bath at 48°C, for approximately 1 hour)
- add 25µL of TE to the pellet, vortex and leave at 4°C for between 1 and 18 hrs (to assist the solubilisation of the DNA). Mix using the automatic stirrer * (a few weeks, -20°C)

7.3. qPCR

For each sample of wine, provide 2 wells with Brett rad3/4 primers and 2 internal standard wells with YAL primers. For each plate, provide a negative control with TE for each pair of primers to be carried out as the final operation. Also perform a positive control on the *Brettanomyces bruxellensis* DNA available at -20°C. To prepare the positive control, add 5µL stock solution (4.5 UG / ml) in a final reaction volume of 25 µL.

PCR amplification programme:

<u>Cycle number</u>	<u>Time (seconds)</u>	<u>Temperature (°C)</u>
1	180	95
40	30	95
	10	64.6
<u>The merged curve is established after 90°C by reducing the heat by 0.5°C every 10 seconds</u>		

**COMPENDIUM OF INTERNATIONAL ANALYSIS OF METHODS – OIV
Enumerating yeasts of the species *Brettanomyces bruxellensis*
using qPCR**

Num. of Brett wells = Num. of YAL wells = 2 x no. of samples + 2

The table below indicates, as a function of the number of samples, the number of wells and the quantity of each constituent of the mixture.

number of samples	number of wells	water at 18 MΩ (μL)	iQ SYBR Green Supermix (μL)	Mixture of 4 μM primers (μL)
1	4	26.3	65.6	13.1
2	6	36.8	91.9	18.4
3	8	47.3	118.1	23.6
4	10	57.8	144.4	28.9
5	12	68.3	170.6	34.1
6	14	78.8	196.9	39.4
7	16	89.3	223.1	44.6
8	18	99.8	249.4	49.9
9	20	110.3	275.6	55.1
10	22	120.8	301.9	60.4
11	24	131.3	328.1	65.6
12	26	141.8	354.4	70.9
13	28	152.3	380.6	76.1
14	30	162.8	406.9	81.4
15	32	173.3	433.1	86.6
16	34	183.8	459.4	91.9
17	36	194.3	485.6	97.1
18	38	204.8	511.9	102.4
19	40	215.3	538.1	107.6
20	42	225.8	564.4	112.9
21	44	236.3	590.6	118.1
22	46	246.8	616.9	123.4
23	48	257.3	643.1	128.6

COMPENDIUM OF INTERNATIONAL ANALYSIS OF METHODS – OIV
Enumerating yeasts of the species *Brettanomyces bruxellensis*
using qPCR

- remove the Brett 4 μ M and the YAL 4 μ M primers from the freezer
- remove the SYBR Green (4°C if tube in current use, otherwise –20°C)
- prepare a Brett mixture and a YAL mixture using the quantities shown in the table above as a function of the number of samples.
- apply 20 μ L of mixture to the bottom of each well
- add 5 μ L of homogenized DNA solution to the automatic stirrer (or 5 μ L of water for the negative controls)
- adjust the optical film and load the plate

7.4. Reading the results

- remove the plate and place it directly in the bag for disposal (**do not open it**)
- set the baseline to 100.
- analyze (in the order indicated below):
 - the negative controls, which should not produce a signal. If a Ct of less than 37 is observed, repeat the process, changing all the solutions,
 - the positive control on Brett: its Ct must be approximately 25, with a melting point of 82.5°C (\pm 0.5°C),
 - YAL internal standards: if a Ct is obtained, check the melting point of the product (84°C \pm 0.5°C). If the product does not conform, the absence of a Brett signal cannot be interpreted,
 - samples: check the T_m of the *Brettanomyces bruxellensis* product (82°C \pm 0.5°C). If and only if the T_m is acceptable, check the exponential profile of the amplification. Then record the Ct values and plot them onto the standard curve.

NB: the Ct represents the time needed for the fluorescence of the target sequence to reach a threshold value. Consequently, it is the minimum number of PCR cycles required for the fluorescent signal to emerge from the background noise.

8. Calculations (Results)

Five *Brettanomyces bruxellensis* strains were inoculated at different concentrations, from 3,1 x 10⁵ to 3 UFC/mL, on 14 wines (3 white wines, 2 rosé wines, 9 red wines whose phenolic compound content varied widely). The DNA was then extracted in the presence of 1% PVPP.

COMPENDIUM OF INTERNATIONAL ANALYSIS OF METHODS – OIV
Enumerating yeasts of the species *Brettanomyces bruxellensis*
using qPCR

A standard curve was established from the set of results obtained on the different combinations of wines and strains.

The results are obtained in GU/mL (genetic unit/mL) from the standard curve

$$\log GU = -\log(2.03) \times Ct + 12.34$$

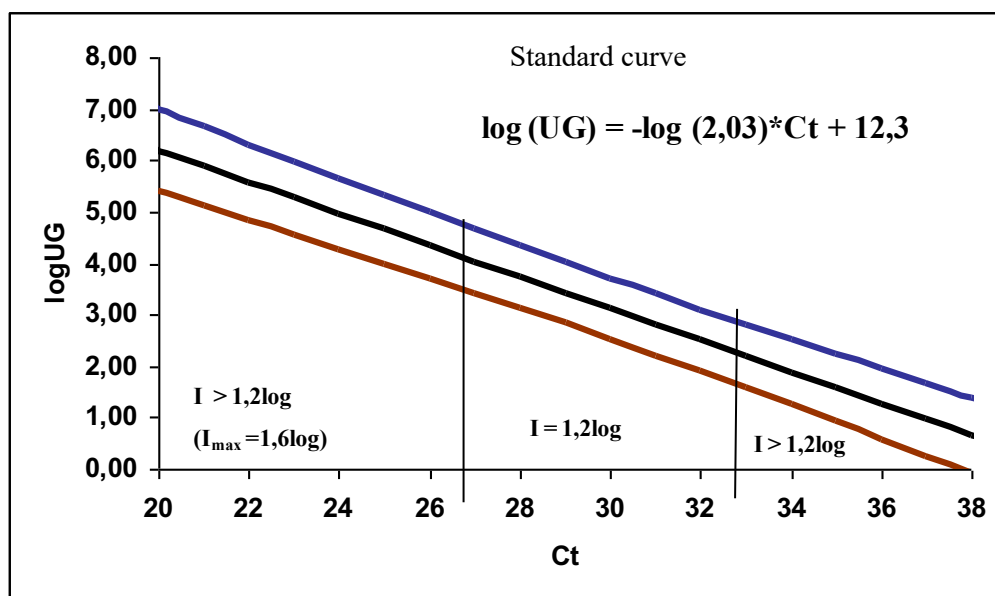

9. Method characteristics: intra-laboratory validation parameters

9.1. Linearity, repeatability and reproducibility [4]

The six-point calibration curve was prepared in the range of 0 to 2×10^5 CFU/mL of the L0211 strain in a wine with four replicates. This population range was selected according to the usual levels of *Brettanomyces bruxellensis* in wines. The measured log GU vs. theoretical log GU relationship was described by simple regression analysis. Regression parameters, slope and intercept were determined as shown in the Table below. The regression model was accepted with a risk $\alpha=1\%$ and the chosen linearity domain validated since no model error was detected.

COMPENDIUM OF INTERNATIONAL ANALYSIS OF METHODS – OIV
Enumerating yeasts of the species *Brettanomyces bruxellensis*
using qPCR

Fidelity of the method was compared to that obtained with the classical culture method. Three operators prepared DNA extracted from a wine inoculated with the L02I1 strain at two levels: 1.9×10^4 (high) or 1.9×10^2 (low) CFU/mL. Four repeats of PCR were performed for each DNA extract. The standard deviation for repeatability and reproducibility, respectively S_r and S_R , were calculated from log GU values for both levels (table below). For the qPCR method, both S_r and S_R were similar for the low population level, but S_R was greater than S_r at high population levels. Both standard deviations were twice as high as those obtained with the classical microbiology method. This effect was attributed to the increased number of steps during the qPCR method.

Table

Parameter	Values
Regression equation	
Range (CFU/mL)	0 to 2×10^5
Slope (\pm SD)	0.957 (0.044)
Intercept (\pm SD)	-0.049 (0.142)
Regression model	$F_{obs} > F(1.18)$: Linear model accepted
Model error	$F_{obs} < F(4.18)$: No model error
Fidelity	
S_r qPCR (low/high)	0.26/0.25
S_r microbio (low/high)	0.17/0.04
S_R qPCR (low/high)	0.29/0.41
S_R microbio (low/high)	0.17/0.04
Accuracy	
Mean 43 samples (D)	2.39 (qPCR)/2.25 (microbio)
S_R D	1.18
Equality test $W=D/S_R D$	$0.11 < 3$ accuracy acceptable

9.2. Limit of detection (LoD) and limit of quantification (LoQ) [4]

LoD and LoQ indicate the sensitivity of the method. LoD is the lowest population detected by the method; LoQ is the minimum of the population that can be quantified accurately. In food product analysis, these parameters are calculated from the background. However in qPCR there is no

background. We thus used two other approaches to evaluate LoD and LoQ. The first method uses slope, intercept and standard error on intercept obtained from linearity validation experiments. With this method, LoD and LoQ values of 3 and 31 GU/mL respectively were obtained. In the second approach, the LD was obtained from the population level resulting in one negative result from 10 independent measurements. Analysis of our data obtained from 14 wines inoculated with five strains revealed that 96% of samples (48/50) containing 101 to 250 CFU/mL resulted in positive signals, while 83% (49/59) were positive if they contained 26 to 100 CFU/mL and 65% (44/68) if 5 to 25 CFU/mL. Thus the limit of detection evaluated from this method would be in the range of 26-100 CFU/mL. By the systematic repetition of each PCR assay, an LoD of 5 CFU/mL was certified thanks to probability calculations $(1 - p)^2$. Indeed for 5 CFU/mL, 88% of samples were positive. This increased to 97% for 25 CFU/mL.

10. References

1. Phister T.G., Mills D.A., 2003. Real-time PCR assay for detection and enumeration of *Dekkera bruxellensis* in wine. *Applied and Environmental Microbiology*, 69: 7430-7434.
2. Cocolin L., Rantsiou K., Iacumin L., Zironi R., Comi G., 2003. Molecular detection and identification of *Brettanomyces/Dekkera bruxellensis* *Brettanomyces/Dekkera anomalous* in spoiled wines. *Applied and Environmental Microbiology*, 70: 1347-1355.
3. Ibeas J.I., Lozano I., Perdignes F., Jimenez J., 1996. Detection of *Dekkera-Brettanomyces* strains in sherry by a nested PCR method. *Applied and Environmental Microbiology*, 62: 998-1003.
4. Tessonière H., Vidal S., Barnavon L., Alexandre H., Remize F., 2009. Design and performance testing of a real-time PCR assay for sensitive and reliable direct quantification of *Brettanomyces* in wine. *International Journal of Food Microbiology*, 129: 237-243.

Differentiation of Fortified Musts and Sweet Fortified Wines

1. Principle of the method

1.1 Method of screening

The product definitions given by the O.I.V. (International Code of Enological Practices) imposes for fortified wines, a minimum of 4% acquired alcohol derived naturally by fermentation; and allows, for fortified musts, a maximum of 1% acquired alcohol. Consequently, these products may be differentiated by identifying their fermentation by-products via gas chromatography.

This method is applicable only if, as the definition anticipates, the alcohol used for production of the fortified musts is neutral.

1.2 Scientific investigation of citramalic acid by thin layer chromatography.

The presence of citramalic acid characterizes sweet fortified wines. Its identification is carried out by thin layer chromatography after separation of the sugars with the use of an ion exchange column.

2. Method of screening

2.1 Apparatus

Gas chromatograph with:

- Flame ionization detector,
- 3 m stainless steel column, 2 mm interior diameter,
- Stationary phase: Carbowax 20 M 20%,
- Support: Chromosorb W 60/80 mesh.

Chromatography conditions:

- temperatures:

injector: 210°C

detector: 250°C

oven: isothermal at 70°C for 6 minutes; then programmed at 6°C/minute; upper temperature limit: 170°C

Other types of columns can be used.

The procedure described below is given as an example.

COMPENDIUM OF INTERNATIONAL METHODS OF ANALYSIS-OIV
Differentiation of fortified musts and sweet fortified wines

2.2 Procedure

2.2.1. Sample preparation

Carry out a separation according to the following conditions: To 25 mL of sample (fortified must or sweet fortified wine) are added to 7 mL ethanol and 15 g of ammonium sulfate, $(\text{NH}_4)_2\text{SO}_4$, agitate. Allow to settle to obtain separation of the phases.

2.2.2 Chromatography

Inject 2 μL of the organic phase and carry out the chromatography in accordance with the conditions indicated above.

The chromatogram of the fortified wine is differentiated by the presence of the peaks of the secondary products of alcoholic fermentation.

3. Investigation of citramalic acid by thin layer chromatography.

3.1 Apparatus

3.1.1 Glass column about 300 mm in length and 10-11 mm interior diameter supplied with a flow regulator (stopcock)

3.1.2 Rotary vacuum evaporator

3.1.3 Oven at 100 °C

3.1.4 Chromatography developing chamber

3.1.5 Micrometric syringe or micropipette

3.2 Reagents

3.2.1 Formic acid solution, 4 M, containing 150.9 mL formic acid ($\rho_{20} = 1.227 \text{ g/mL}$) per liter.

3.2.2 Plates for chromatography ready to use with a layer of cellulose powder (for example MN 300) (20 x 20 cm).

3.2.3 Solvent:

iso-Propyl alcohol containing 1 g/L bromophenol blue
5 vol.

Eucalyptol5 vol.

Formic acid ($\rho_{20} = 1.227 \text{ g/mL}$) 2
vol.

Saturate the solvent with water and allow to stand for 24 hours before use.

3.2.4 Standard solutions.

Prepare an aqueous solution of:

COMPENDIUM OF INTERNATIONAL METHODS OF ANALYSIS-OIV
Differentiation of fortified musts and sweet fortified wines

Citramalic acid	0.25 g/L
Lactic acid	0.5 g/L
Citric acid	0.5 g/L
Tartaric acid	1.0 g/L
Malic acid	1.0 g/L

3.3 Procedure

3.3.1 Preparation of the ion exchange column.

See chapter on *Tartaric acid*, usual method in 3.3.1.

3.3.2 Isolation of the organic acid of citramalic acid

Proceed as indicated in the chapter *Tartaric acid*, usual method in 3.3.2. for the fixation of organic acids on the ion exchanger.

Then elute the fixed acids using the 4 M formic acid solution (100 mL), collecting the eluate in a 100 mL volumetric flask.

Concentrate the eluate dry in a rotary evaporator at 40°C recovering the residue with 1 mL of distilled water.

3.3.3 Chromatography

The cellulose plate must be activated by placing it in the oven at 100°C for 2 hours.

Deposit on the starting line of the cellulose plate in a band 2 cm wide, 10 µL of this solution as well as 10 µL of the standard solutions of citramalic acid and the other organic acids.

Place the plate in the chromatography bath, above the solvent, for 45 minutes.

Proceed with the development and let the solvent migrate to a height of 15 cm.

3.3.4 Development of the chromatogram

Maintain the plate at ambient temperature under an air current, until the formic acid of the solvent is eliminated. Yellow spots appear on a blue background, indicating the presence of the acids.

Detect the presence or absence of citramalic acid in the product analyzed by comparing the spots of this chromatogram to the spots of standard solutions of citramalic acid and the other organic acids.

BIBLIOGRAPHY

Method of Screening:

HARVALIA A., *F.V., O.I.V.*, 1980, n° 728 bis.

Chromatography of citramalic acid:

DIMOTAKI-KOURAKOU V., *Ann. Fals. Exp. Chim.*, 1960, **53**, 149.

DIMOTAKI-KOURAKOU V., *C. R. Ac. Sci.*, Paris 1962, **254**, 4030.

CARLES J., LAMAZOU-BETBEDER M. & PECH M., *C. R. Ac. Sci.*, Paris 1958, **246**, 2160.

CASTINO M., *Riv. Vit. Enol.*, 1967, **6**, 247.

KOURAKOU V., *F.V., O.I.V.*, 1977, n° 642.

JUNGE Ch *F.V., O.I.V.*, 1978, n° 679.

ROUEN J., *F.V., O.I.V.*, 1979, n° 691.

Annex B

Certificates of analysis

Rules for the implementation of the analytical methods

The control of the quality of wines should always allow, on one hand, a sensory examination and, on the other hand, the determination of the essential characteristic elements of their composition.

Sensory analysis has not been studied in the present book; it is left to the evaluation of the various countries, but is required in every case.

With regard to the elements of the composition of wines, three types of determinations can or must be performed:

1. The determinations that serve to identify the wines and can serve as basis of commercial transactions (Certificate no. 1);
2. The determinations that permit us to ascertain satisfactorily the qualities and characteristics of a wine and which, in this manner, correspond to trade practices (Certificate no. 2).

Determinations other than anticipated in the Certificates numbers 1 and 2 can be required within a contractual framework.

3. A third Certificate (no. 3) can be considered which would contain specific determinations that are only carried out on an exceptional or special basis.

Resorting to the determinations aimed at Certificate no. 2 could be such as to exonerate the operators from liability.

The recourse to the determinations of the Certificate no. 3 could be such as to exonerate importers from liability.

When the public health is involved, other determinations can be required either by the OIV, the public authorities, or by all interested parties when serious doubts appear in the industry or among consumers.

The public health exception may be submitted, by all parties interested, to the special group of scientific experts of the Office according to an emergency procedure.

COMPENDIUM OF INTERNATIONAL METHODS OF ANALYSIS -OIV
Rules for the implementation of the analytical methods

The analytical determinations are performed, when they exist, according to the methods described in the present book.

Certificates of Analysis

Certificate No. 1

- Color
- Clarity
- Specific gravity at 20←C
- Alcoholic content at 20←C
- Total dry extract g/L
- Sugar g/L
- Total sulfur dioxide mg/L
- pH
- Total acidity meq/L
- Volatile acidity meq/L
- Test for malvidin diglucoside
- Over pressure measurement of carbon dioxide in sparkling wines
- Differentiation of very sweet wine and fortified must in the case of sweet wines

Certificate No. 2

Certificate No. 1 is completed and the following determinations are added:

- Ash and alkaline ash g/L
- Potassium g/L
- Iron mg/L
- Copper mg/L
- Free sulfur dioxide mg/L
- Sorbic acid mg/L
- Verification of malolactic fermentation
- Citric acid mg/L
- Tartaric acid g/L
- Folin-Ciocalteu Index
- Chromatic Indexes

The following determinations are optional:

- Excess sodium mg/L
- Calcium, magnesium mg/L
- Sulfates mg/L
- Test of fermentability
- Test for artificial colorants

Annex C

**Maximum acceptable limits
of various substances**

**Maximum acceptable limits of various
substances
contained in wine**
(2023 Issue)

Citric acid:	1 g/L
Volatile acidity:	20 milliequivalents/L The volatile acidity of various specially fortified old wines (wines subject to special legislation and controlled by the government) may exceed this limit.
Arsenic:	0.2 mg/L
Boron:	80 mg/L (expressed as boric acid)
Bromine:	1 mg/L (limit exceeded by way of exception in wines from certain vineyards with a brackish subsoil).
Cadmium:	0.01 mg/L
Copper: (oen 434-2011)	1 mg/L 2 mg/L for liqueur wines produced from unfermented or slightly fermented grape must
Diethylene glycol:	≤ 10 mg/L, to the quantification limit

COMMENDIUM OF INTERNATIONAL METHODS OF ANALYSIS-OIV
Maximum acceptable limits of various substances contained in wine

Malvidol diglucoside:	15 mg/L (determined by the quantitative method diglucoside described in the Compendium)
-----------------------	---

Silver	< 0.1 mg/L
--------	------------

Total sulfur dioxide at the time of sale to the consumer: (oen 9/98)	<ul style="list-style-type: none">- 150 mg/L for red wines containing a maximum of 4 g/L of reducing substances.- 200 mg/L for white and rosé wines containing a maximum of 4 g/L of reducing substances.- 300 mg/L: red, rosé and white wines containing more than 4 g/L of reducing substances.- 400 mg/L: in exceptional cases some sweet white wines.
--	--

Ethanediol glycol: /Ethylene	≤ 10 mg/L
------------------------------	-----------

Fluoride: (oen 8/91)	1 mg/L except for wines coming from vineyards treated in conformity with national law, with cryolite in which case, the level of fluoride must not exceed 3 mg/L.
----------------------	---

Methanol:	400 mg/L for red wines
(oen 19/2004)	250 mg/L for white and rosé wines

Ochratoxin A :	2 µg/L (for wines obtained as from the 2005 harvest)
(CST 1/2002)	

COMMENDIUM OF INTERNATIONAL METHODS OF ANALYSIS-OIV
Maximum acceptable limits of various substances contained in wine

Lead: (oen 638/19)	0.10 mg/L for wine, produced starting from the 2019 harvest year 0.15 mg/L for liqueur wines, produced starting from the 2019 harvest year ¹
--------------------	--

Propan-1,2-diol/ propylene glycol (oen 20/2003)	Still wines : = 150 mg/L Sparkling wines : = 300 mg/L
---	--

Excess sodium: (oen 09/2007)	80 mg/L
---------------------------------	---------

Sulfates: (expressed as potassium sulfate)	1 g/L	
	However this limit is raised to:	
	- for wines which have undergone a maturing period in casks for at least 2 years	} 1.5 g/L
	- for sweetened wines	
	- for wines obtained by the addition to the musts or wine of alcohol or potable spirit	
- for wines with added concentrated musts	} 2.0 g/L	
- for naturally sweet wines		
- for wines obtained under a film "sous voile"	} 2.5 g/L	

Zinc	5 mg/L
------	--------

¹ For liqueur wines subject to extended periods of aging, the applicable limit is that in force at the time of their production.

Annex D

Advices

Gluconic acid

OENO 4/91

Gluconic acid is always present in musts and wines.

In wines derived from a sound, mature harvest, its level does not exceed 200—300 mg/L.

Gluconic acid increases through over—ripening by raisining and especially by the intervention of *Botrytis cinerea*.

Its presence at higher levels in wines — other than wines infected with noble rot of which gluconic acid is a characteristic constituent — cannot be considered a sign of bad quality linked to a harvest seized with gray rot, which must be demonstrated by other means. In fact, by appropriate vinification techniques, it is possible to obtain wines of quality in this case.

As to fraud by addition of gluconic acid, this is not a factor to be taken into account since there is no reason for it.

**Characterization of wines resulting from
overpressing**
OENO 5/91

NOTICE

In view of the results of the discussions concerning the tests on DESCRIPTIVE CHARACTERISTICS OF WINES RESULTING FROM OVERPRESSING, the experts have confirmed that, for the group of tests done, the behavior of wines is very different depending on the variety. This renders impossible all interpretation concerning wines coming from several varieties.

Moreover, the effects of the different methods of pressing and of vinification techniques, such as prefermentation maceration, must be taken into account.

Studies must be pursued to show wines resulting from overpressing and a definition of overpressing sought after.

The level of sodium and chloride ions in wines

OENO 6/91

NOTICE

The level of Chloride and sodium ions in wines essentially depends on the geographic, geologic and climatic conditions of vine culture.

As a general rule, the levels of these ions are low.

the content of these elements is increased in wines coming from vineyards which are near the sea coast, which have brackish sub-soil or which have arid ground irrigated with salt water and the molar ratio of Cl/Na^+ therefore varies significantly and can even have a value close to one (1) which could imply the addition of salt (NaCl) to the wine.

When wine contains excess sodium (excess sodium is equal to the content of sodium ions less the content of chloride ions expressed as sodium), it is generally less than 60 mg/L, a limit which may be exceeded in exceptional cases.

The laboratories and official control agencies, confronted with elevated levels of Cl and/or Na^+ , must take the above conclusions into account and possibly make inquiries to the official agencies of the country of *origin* before expelling these wines.

Total dry extract
(Total dry extract, total dry extract without sugars, residual
extracts)
(OIV-CST 668-2022)

Dry extract (total dry extract also called total dry matter, sugar free dry extract also called non-reducing extract, residual extract

The dry extract of musts and wines includes all matter that is non-volatile when measured under specified physical conditions. These physical conditions must be such that the matter forming the dry extract undergoes as little alteration as possible while the analyse is being carried out.

The total dry extract, sugar free dry extract and residual extract are defined and measured as described in the OIV COMPENDIUM OF INTERNATIONAL METHODS OF ANALYSIS in Method OIV-MA-AS2-03A and Method OIV-MA-AS2-03B.

The value obtained for the dry extract depends solely on a physical measurement of non-volatile compounds of musts and wines (sugars, acids, minerals ...) that vary from one harvest to another, from one harvesting location to another, could be impacted by seasonal and regional weather conditions and irrigation practices, and is also influenced by the wine making process including the use of permitted additives.

It is therefore not possible to establish fixed reference values which allow detection of wine frauds solely through measurement of total dry extract or, sugar free dry extract or residual extract, while it can be used in conjunction with other parameters to evaluate a possible fraud.

The OIV declares that the sole measurement of the total dry extract, total dry matter, sugar free dry extract or residual extract, if considered in isolation, it's not sufficient for the detection of possible frauds.

Annex E

**Laboratory quality
assurance**

**Principle of validation of routine methods with respect to
reference methods**

(Resolution OENO 7/98)

The OIV acknowledges the existence of methods of analysis of wines in addition to those described in the Summary of International Methods of Analysis of Wines and Musts, of common methods most often automated. These methods are economically and commercially important because they permit maintaining a complete and efficient analytical framework around the production and marketing of wine. Moreover, these methods allow the use of modern means of analysis and the development and adaptation of techniques of analysis.

In order to allow laboratories to use these methods and to insure their linkage to methods described within the Summary, the OIV decides to establish a plan of evaluation and validation by a laboratory of an alternative, common method, mechanized or not with respect to a reference method described in the Summary of International Methods of Analysis of Wines and Musts.

This principle, which will be adapted to the particular situation of the analysis of wines and musts, will take its inspiration from international standards in current use and allow the laboratory to assess and validate its alternative method in two ways:

Collaborative Study

The purpose of the collaborative study is to give a quantified indication of the precision of method of analysis, expressed as its repeatability r and reproducibility R .

Repeatability: the value below which the absolute difference between two single test results obtained using the same method on identical test material, under the same conditions (same operator, same apparatus, same laboratory and a short period of time) may be expected to lie within a specified probability.

Reproducibility: the value below which the absolute difference between two single test results obtained using the same method on identical test material, under different conditions (different operators, different apparatus and/or different laboratories and/or different time) may be expected to lie within a specified probability.

The term "individual result" is the value obtained when the standardized trial method is applied, once and fully, to a single sample. Unless otherwise stated, the probability is 95%.

General Principles

- The method subjected to trial must be standardized, that is, chosen from the existing methods as the method best suited for subsequent general use.
- The protocol must be clear and precise.
- The number of laboratories participating must be at least ten.
- The samples used in the trials must be taken from homogeneous batches of material.
- The levels of the analyte to be determined must cover the concentrations generally encountered.
- Those taking part must have a good experience of the technique employed.
- For each participant, all analyses must be conducted within the same laboratory by the same analyst.
- The method must be followed as strictly as possible. Any departure from the method described must be documented.
- The experimental values must be determined under strictly identical conditions: on the same type of apparatus, etc.
- They must be determined independently of each other and immediately after each other.
- The results must be expressed by all laboratories in the same units, to the same number of decimal places.
- Five replicate experimental values must be determined, free from outliers. If an experimental value is an outlier according to the Grubbs test, three additional measurements must be taken.

Statistical Model

The statistical methods set out in this document are given for one level (concentration, sample). If there are a number of levels, the statistical evaluation must be made separately for each. If a linear relationship is found ($y = bx$ or $y = a + bx$) as between the repeatability (r) or reproducibility (R) and the concentration (\bar{X}), a regression of r (or R) may be run as a function of \bar{X} .

The statistical methods given below suppose normally-distributed random values.

The steps to be followed are as follows:

- A/ Elimination of outliers within a single laboratory by Grubbs test. Outliers are values which depart so far from the other experimental values that these deviations cannot be regarded as random, assuming the causes of such deviations are not known.
- B/ Examine whether all laboratories are working to the same precision, by comparing variances by the Bartlett test and Cochran test. Eliminate those laboratories for which statistically deviant values are obtained.
- C/ Track down the systematic errors from the remaining laboratories by a variance analysis and by a Dixon test identify the extreme outlier values. Eliminate those laboratories for which the outlier values are significant.
- D/ From the remaining figures, calculate standard deviation of repeatability); S_r , and repeatability r standard deviation of reproducibility S_R and reproducibility R .

Notation:

The following designations have been chosen:

m	Number of laboratories
$i(i = 1, 2... m)$	Index (No. of the laboratory)
n_i	Number of individual values from the i th laboratory
$N = \sum_{i=1}^m n_i$	Total number of individual values
$x(i = 1, 2... n_i)$	Individual value of the i th laboratory
$\bar{x}_i = \frac{1}{n_i} \sum_{i=1}^{n_i} x_i$	Mean value of the i th laboratory
$\bar{X} = \frac{1}{N} \sum_{i=1}^m \sum_{i=1}^{n_i} x_i$	Total mean value
$s_i = \sqrt{\frac{1}{n_i-1} \sum_{i=1}^{n_i} (x_i - \bar{x}_i)^2}$	Standard deviation of the i th laboratory

A/ Verification of outlier values within one laboratory

After determining five individual values x_i , a Grubbs test is performed at the laboratory, to identify the outliers' values.

Test the null hypothesis whereby the experimental value with the greatest absolute deviation from the mean is not an outlier observation.

$$\text{Calculate PG} = \frac{|x_i^* - \bar{x}_i|}{s_i}$$

x_i^* = suspect value

Compare PG with the corresponding value shown in Table 1 for P = 95%.

If PG < value as read, value x_i^* is not an outlier and s_i can be calculated.

If PG > value as read, value x_i^* probably is an outlier therefore make a further three determinations.

Calculate the Grubbs test for x_i^* with the eight determinations.

If PG > corresponding value for P = 99%, regard x_i^* as a deviant value and calculate s_i without x_i^* .

**B/ Comparison of variances among laboratories
- Bartlett Test**

The Bartlett test allows us to examine both major and minor variances. It serves to test the null hypothesis of the equality of variances in all laboratories, as against the alternative hypothesis whereby the variances are not equal in the case of some laboratories.

At least five individual values are required per laboratory.

Calculate the statistics of the test:

$$PB = \frac{1}{C} \left[(N-m) \ln S_r^2 - \sum_{i=1}^m f_i \ln s_i^2 \right]$$

$$C = \frac{\sum_{i=1}^m \frac{1}{f_i} - \frac{1}{N-m}}{3(m-1)} + 1$$

$$S_r^2 = \frac{\sum_{i=1}^m f_i s_i^2}{N-m}$$

$f_i = n_i - 1$ degrees of freedom of s_i .

Compare PB with the value x^2 indicated in table 2 at $m - 1$ degrees of freedom.

If $PB >$ the value in the table, there are differences among the variances.

The Cochran test is used to confirm that the variance from one laboratory is greater than that from other laboratories.

Calculate the test statistics:

$$PC = \frac{s_i^2 \max}{\sum_{i=1}^m s_i^2}$$

Compare PC with the value shown in table 3 for m and n_i at $P = 99\%$.

If $PC >$ the table value, the variance is significantly greater than the others.

If there is a significant result from the Bartlett or Cochran tests, eliminate the outlier variance and calculate the statistical test again.

In the absence of a statistical method appropriate to a simultaneous test of several outlier values, the repeated application of the tests is permitted, but should be used with caution.

If the laboratories produce variances that differ sharply from each other, an investigation must be made to find the causes and to decide whether the experimental values found by those laboratories are to be eliminated or not. If they are, the coordinator will have to consider how representative the remaining laboratories are.

If statistical analysis shows that there are differing variances, this shows that the laboratories have operated the methods at varying precisions. This may be due to inadequate practice or to lack of clarity or inadequate description in the method.

C/ Systematic errors

Systematic errors made by laboratories are identified using either Fischer's method or Dixon's test.

R .A. Fischer variance analysis

This test is applied to the remaining experimental values from the laboratories with an identical variance.

The test is used to identify whether the spread of the mean values from the laboratories is very much greater than that for the individual values expressed by the variance among the laboratories (S_L^2) or the variance within the laboratories (S^2).

Calculate the test statistics:

$$PF = \frac{s_z^2}{s_l^2}$$

$$s_z^2 = \frac{1}{m-1} \sum_{i=1}^m n_i (\bar{x}_i - \bar{x})^2$$

$$s_l^2 = \frac{1}{N-m} \sum_{i=1}^m \sum_{j=1}^{n_i} (x_{ij} - \bar{x}_i)^2$$

Compare PF with the corresponding value shown in table 4 (distribution of F) where $f_1 = f_z = m - 1$ and $f_2 = f_l = N - m$ degrees of freedom.

If $PF >$ the table value, it can be concluded that there are differences among the means, that is, there are systematic errors.

Dixon test

This test enables us to confirm that the mean from one laboratory is greater or smaller than that from the other laboratories.

Take a data series $Z(h)$, $h = 1, 2, 3, \dots, H$, ranged in increasing order.

Calculate the statistics for the test:

3 to 7	$Q_{10} = \frac{Z(2) - Z(1)}{Z(H) - Z(1)}$	or	$\frac{Z(H) - Z(H-1)}{Z(H) - Z(1)}$
8 to 12	$Q_{11} = \frac{Z(2) - Z(1)}{Z(H-1) - Z(1)}$	or	$\frac{Z(H) - Z(H-1)}{Z(H) - Z(2)}$
13 plus	$Q_{22} = \frac{Z(3) - Z(1)}{Z(H-2) - Z(1)}$	or	$\frac{Z(H) - Z(H-2)}{Z(H) - Z(3)}$

Compare the greatest value of Q with the critical values shown in table 5.

If the test statistic is $>$ the table value at $P = 95\%$, the mean in question can be regarded as an outlier.

If there is a significant result in the R A Fischer variance analysis or the Dixon test, eliminate one of the extreme values and calculate the test statistics again with the remaining values. As regards repeated application of the tests, see the explanations in paragraph (B).

If the systematic errors are found, the corresponding experimental values concerned must not be included in subsequent computations; the cause of the systematic error must be investigated.

D/Calculating repeatability (*r*) and reproducibility (*R*).

From the results remaining after elimination of outliers, calculate the standard deviation of repeatability s_r and repeatability r , and the standard deviation of reproducibility s_R and reproducibility R , which are shown as characteristic values of the method of analysis.

$$s_r = \sqrt{\frac{1}{N-m} \sum_{i=1}^m f_i s_i^2} \qquad r = s_r \cdot 2\sqrt{2}$$

$$s_R = \sqrt{\frac{1}{a} [s_Z^2 + (a-1)s_J^2]} \qquad R = s_R \cdot 2\sqrt{2}$$

$$a = \frac{1}{m-1} \left[\left(N - \sum_{i=1}^m \frac{n_i^2}{N} \right) \right]$$

If there is no difference between the means from the laboratories, then there is no difference between s_r and s_R or between r and R . But, if we find differences among the laboratory means, although these may be tolerated for practical considerations, we have to show s_r and s_R , and r and R .

BIBLIOGRAPHY

- AFNOR, norme NFX06041, *Fidélité des méthodes d'essai. Détermination de la répétabilité et de la reproductibilité par essais interlaboratoires.*
- DAVIES O. L., GOLDSMITH P.I., *Statistical Methods in Research and Production*, Oliver and Boyd, Edinburgh, 1972.
- GOETSCH F. H., KRÖNERT W., OLSCHIMKE D., OTTO U., VIERKÖTTER S., *Meth. An.*, 1978, No 667.
- GOTTSCHALK G., KAISER K. E., *Einführung in die Varianzanalyse und Ringversuche*, B-1 Hoschultaschenbücher, Band 775, 1976.
- GRAF, HENNING, WILRICH, *Statistische Methoden bei textilen Untersuchungen*, Springer Verlag, Berlin, Heidelberg, New York, 1974.
- GRUBBS F. E., *Sample Criteria for Testing Outlying Observations*, The Annals of Mathematical Statistics, 1950, vol. 21, p 27-58.
- GRUBBS F. E., *Procedures for Detecting Outlying Observations in Samples*, Technometrics, 1969, vol. 11, No 1, p 1-21.
- GRUBBS F. E. and BECK G., *Extension of Sample Sizes and Percentage Points for Significance Tests of Outlying Observations*, Technometrics, 1972, vol. 14, No 4, p 847-854.
- ISO, norme 5725.
- KAISER R., GOTTSCHALK G., *Elementare Tests zur Beurteilung von Messdaten*, B-I Hochschultaschenbücher, Band 774, 1972.
- LIENERT G. A., *Verteilungsfreie Verfahren in der Biostatistik*, Band I, Verlag Anton Hain, Meisenheim am Glan, 1973.
- NALIMOV V. V., *The Application of Mathematical Statistics to Chemical Analysis*, Pergamon Press, Oxford, London, Paris, Frankfurt, 1963.
- SACHS L., *Statistische Auswertungsmethoden*, Springer Verlag, Berlin, Heidelberg, New York, 1968.

**COMPENDIUM OF INTERNATIONAL METHODS OF ANALYSIS–OIV
Collaborative Study**

Table 1 - Critical values for the Grubbs test

n_i	P = 95%	P 99%
3	1,155	1,155
4	1,481	1,496
5	<u>1,715</u>	1,764
6	1,887	1,973
7	2,020	2,139
8	2,126	<u>2,274</u>
9	2,215	2,387
10	2,290	2,482
11	2,355	2,564
12	2,412	2,636

Table 2 – Critical values for the Bartlett test (P = 95%)

$f(m - 1)$	X^2	$f(m - 1)$	X^2
1	3,84	21	32,7
2	5,99	22	33,9
3	7,81	23	35,2
4	9,49	24	36,4
5	11,07	25	37,7
6	12,59	26	38,9
7	14,07	27	40,1
8	15,51	28	41,3
9	16,92	29	42,6
10	18,31	30	43,8
11	19,68	35	49,8
12	21,03	40	55,8
13	22,36	50	67,5
14	23,69	60	79,1
15	25,00	70	90,5
16	26,30	80	101,9
17	27,59	90	113,1
18	28,87	100	124,3
19	30,14		
20	31,41		

**COMPENDIUM OF INTERNATIONAL METHODS OF ANALYSIS–OIV
Collaborative Study**

Table 3 – Critical values for the Cochran test

<i>m</i>	<i>n_i</i> = 2		<i>n_i</i> = 3		<i>n_i</i> = 4		<i>n_i</i> = 5		<i>n_i</i> = 6	
	99%	95%	99%	95%	99%	95%	99%	95%	99%	95%
2	-	-	0.995	0.975	0.979	0.939	0.959	0.906	0.937	0.877
3	0.993	0.967	0.942	0.871	0.883	0.798	0.834	0.746	0.793	0.707
4	0.968	0.906	0.864	0.768	0.781	0.684	0.721	0.629	0.676	0.590
5	0.928	0.841	0.788	0.684	0.696	0.598	0.633	0.544	0.588	0.506
6	0.883	0.781	0.722	0.616	0.626	0.532	0.564	0.480	0.520	0.445
7	0.838	0.727	0.664	0.561	0.568	0.480	0.508	0.431	0.466	0.397
8	0.794	0.680	0.615	0.516	0.521	0.438	0.463	0.391	0.423	0.360
9	0.754	0.638	0.573	0.478	0.481	0.403	0.425	0.358	0.387	0.329
10	0.718	0.602	0.536	0.445	0.447	0.373	0.393	0.331	0.357	0.303
11	0.684	0.570	0.504	0.417	0.418	0.348	0.366	0.308	0.332	0.281
12	0.653	0.541	0.475	0.392	0.392	0.326	0.343	0.288	0.310	0.262
13	0.624	0.515	0.450	0.371	0.369	0.307	0.322	0.271	0.291	0.246
14	0.599	0.492	0.427	0.352	0.349	0.291	0.304	0.255	0.274	0.232
15	0.575	0.471	0.407	0.335	0.332	0.276	0.288	0.242	0.259	0.220
16	0.553	0.452	0.388	0.319	0.316	0.262	0.274	0.230	0.246	0.208
17	0.532	0.434	0.372	0.305	0.301	0.250	0.261	0.219	0.234	0.198
18	0.514	0.418	0.356	0.293	0.288	0.240	0.249	0.209	0.223	0.189
19	0.496	0.403	0.343	0.281	0.276	0.230	0.238	0.200	0.214	0.181
20	0.480	0.389	0.330	0.270	0.265	0.220	0.229	0.192	0.205	0.174
21	0.465	0.377	0.318	0.261	0.255	0.212	0.220	0.185	0.197	0.167
22	0.450	0.365	0.307	0.252	0.246	0.204	0.212	0.178	0.189	0.160
23	0.437	0.354	0.297	0.243	0.238	0.197	0.204	0.172	0.182	0.155
24	0.425	0.343	0.287	0.235	0.230	0.191	0.197	0.166	0.176	0.149
25	0.413	0.334	0.278	0.228	0.222	0.185	0.190	0.160	0.170	0.144
26	0.402	0.325	0.270	0.221	0.215	0.179	0.184	0.155	0.164	0.140
27	0.391	0.316	0.262	0.215	0.209	0.173	0.179	0.150	0.159	0.135
28	0.382	0.308	0.255	0.209	0.202	0.168	0.173	0.146	0.154	0.131
29	0.372	0.300	0.248	0.203	0.196	0.164	0.168	0.142	0.150	0.127
30	0.363	0.293	0.241	0.198	0.191	0.159	0.164	0.138	0.145	0.124
31	0.355	0.286	0.235	0.193	0.186	0.155	0.159	0.134	0.141	0.120
32	0.347	0.280	0.229	0.188	0.181	0.151	0.155	0.131	0.138	0.117

**COMPENDIUM OF INTERNATIONAL METHODS OF ANALYSIS–OIV
Collaborative Study**

33	0.339	0.273	0.224	0.184	0.177	0.147	0.151	0.127	0.134	0.114
34	0.332	0.267	0.218	0.179	0.172	0.144	0.147	0.124	0.131	0.111
35	0.325	0.262	0.213	0.175	0.168	0.140	0.144	0.121	0.127	0.108
36	0.318	0.256	0.208	0.172	0.165	0.137	0.140	0.119	0.124	0.106
37	0.312	0.251	0.204	0.168	0.161	0.134	0.137	0.116	0.121	0.103
38	0.306	0.246	0.200	0.164	0.157	0.131	0.134	0.113	0.119	0.101
39	0.300	0.242	0.196	0.161	0.154	0.129	0.131	0.111	0.116	0.099
40	0.294	0.237	0.192	0.158	0.151	0.126	0.128	0.108	0.114	0.097

Table 4 – Critical values for the F-Test (P=99%)

$f_2 \backslash f_1$	1	2	3	4	5	6	7	8	9	10	11	12	13	14	15
1	4052	4999	5403	5625	5764	5859	5928	5981	6023	6056	6083	6106	6126	6143	6157
2	98.5	99.0	99.2	99.3	99.3	99.3	99.4	99.4	99.4	99.4	99.4	99.4	99.4	99.4	99.4
3	34.1	30.8	29.4	28.7	28.2	27.9	27.7	27.5	27.3	27.2	27.1	27.1	27.0	26.9	26.9
4	21.2	18.0	16.7	16.0	15.5	15.2	15.0	14.8	14.7	14.5	14.5	14.4	14.3	14.2	14.2
5	16.3	13.3	12.1	11.4	11.0	10.7	10.5	10.3	10.2	10.1	9.96	9.89	9.82	9.77	9.72
6	13.7	10.9	9.78	9.15	8.75	8.47	8.26	8.10	7.98	7.87	7.79	7.72	7.66	7.60	7.56
7	12.2	9.55	8.45	7.85	7.46	7.19	6.99	6.84	6.72	6.62	6.54	6.47	6.41	6.36	6.31
8	11.3	8.65	7.59	7.01	6.63	6.37	6.18	6.03	5.91	5.81	5.73	5.67	5.61	5.56	5.52
9	10.6	8.02	6.99	6.42	6.06	5.80	5.61	5.47	5.35	5.26	5.18	5.11	5.05	5.01	4.96
10	10.0	7.56	6.55	5.99	5.64	5.39	5.20	5.06	4.94	4.85	4.77	4.71	4.65	4.60	4.56
11	9.64	7.20	6.21	5.67	5.31	5.07	4.88	4.74	4.63	4.54	4.46	4.39	4.34	4.29	4.25
12	9.33	6.93	5.95	5.41	5.06	4.82	4.64	4.50	4.39	4.30	4.22	4.16	4.10	4.05	4.01
13	9.07	6.70	5.74	5.21	4.86	4.62	4.44	4.30	4.19	4.10	4.02	3.96	3.90	3.86	3.82
14	8.86	6.51	5.56	5.04	4.69	4.46	4.28	4.14	4.03	3.94	3.86	3.80	3.75	3.70	3.66
15	8.68	6.36	5.42	4.89	4.56	4.32	4.14	4.00	3.89	3.80	3.73	3.67	3.61	3.56	3.52
16	8.53	6.23	5.29	4.77	4.44	4.20	4.03	3.89	3.78	3.69	3.62	3.55	3.50	3.45	3.41
17	8.40	6.11	5.18	4.67	4.34	4.10	3.93	3.79	3.68	3.59	3.52	3.46	3.40	3.35	3.31
18	8.29	6.01	5.09	4.58	4.25	4.01	3.84	3.71	3.60	3.51	3.43	3.37	3.32	3.27	3.23
19	8.18	5.93	5.01	4.50	4.17	3.94	3.77	3.63	3.52	3.43	3.36	3.30	3.24	3.19	3.15
20	8.10	5.85	4.94	4.43	4.10	3.87	3.70	3.56	3.46	3.37	3.29	3.23	3.18	3.13	3.09
21	8.02	5.78	4.87	4.37	4.04	3.81	3.64	3.51	3.40	3.31	3.24	3.17	3.12	3.07	3.03
22	7.95	5.72	4.82	4.31	3.99	3.76	3.59	3.45	3.35	3.26	3.18	3.12	3.07	3.02	2.98
23	7.88	5.66	4.76	4.26	3.94	3.71	3.54	3.41	3.30	3.21	3.14	3.07	3.02	2.97	2.93
24	7.82	5.61	4.72	4.22	3.90	3.67	3.50	3.36	3.26	3.17	3.09	3.03	2.98	2.93	2.89
25	7.77	5.57	4.68	4.18	3.85	3.63	3.46	3.32	3.22	3.13	3.06	2.99	2.94	2.89	2.85
26	7.72	5.53	4.64	4.14	3.82	3.59	3.42	3.29	3.18	3.09	3.02	2.96	2.90	2.86	2.81
27	7.68	5.49	4.60	4.11	3.78	3.56	3.39	3.26	3.15	3.06	2.99	2.93	2.87	2.82	2.78
28	7.64	5.45	4.57	4.07	3.75	3.53	3.36	3.23	3.12	3.03	2.96	2.90	2.84	2.79	2.75
29	7.60	5.42	4.54	4.04	3.73	3.50	3.33	3.20	3.09	3.00	2.93	2.87	2.81	2.77	2.73
30	7.56	5.39	4.51	4.02	3.70	3.47	3.30	3.17	3.07	2.98	2.91	2.84	2.79	2.74	2.70
40	7.31	5.18	4.31	3.83	3.51	3.29	3.12	2.99	2.89	2.80	2.73	2.66	2.61	2.56	2.52
50	7.17	5.06	4.20	3.72	3.41	3.19	3.02	2.89	2.78	2.70	2.62	2.56	2.51	2.46	2.42
60	7.07	4.98	4.13	3.65	3.34	3.12	2.95	2.82	2.72	2.63	2.56	2.50	2.44	2.39	2.35

**COMPENDIUM OF INTERNATIONAL METHODS OF ANALYSIS–OIV
Collaborative Study**

70	7.01	4.92	4.07	3.60	3.29	3.07	2.91	2.78	2.67	2.59	2.51	2.45	2.40	2.35	2.31
80	6.96	4.88	4.04	3.56	3.25	3.04	2.87	2.74	2.64	2.55	2.48	2.42	2.36	2.31	2.27
90	6.92	4.85	4.01	3.53	3.23	3.01	2.84	2.72	2.61	2.52	2.45	2.39	2.33	2.29	2.24
100	6.89	4.82	3.98	3.51	3.21	2.99	2.82	2.69	2.59	2.50	2.43	2.37	2.31	2.27	2.22
200	6.75	4.71	3.88	3.41	3.11	2.89	2.73	2.60	2.50	2.41	2.34	2.27	2.22	2.17	2.13
500	6.69	4.65	3.82	3.36	3.05	2.84	2.68	2.55	2.44	2.36	2.29	2.22	2.17	2.12	2.07
∞	6.63	4.61	3.78	3.32	3.02	2.80	2.64	2.51	2.41	2.32	2.25	2.18	2.13	2.08	2.04

Table 4 – Critical values for the F-Test (P=99%) [Continued]

f_1 f_2	16	17	18	19	20	30	40	50	60	70	80	100	200	500	∞
1	6169	6182	6192	6201	6209	6261	6287	6303	6313	6320	6326	6335	6350	6361	6366
2	99.4	99.4	99.4	99.4	99.5	99.5	99.5	99.5	99.5	99.5	99.5	99.5	99.3	99.5	99.5
3	26.8	26.8	26.8	26.7	26.7	26.5	26.4	26.4	26.3	26.3	26.3	26.2	26.2	26.1	26.1
4	14.2	14.1	14.1	14.0	14.0	13.8	13.7	13.7	13.7	13.6	13.6	13.6	13.5	13.5	13.5
5	9.68	9.64	9.61	9.58	9.55	9.38	9.29	9.24	9.20	9.18	9.16	9.13	9.08	9.04	9.02
6	7.52	7.48	7.45	7.42	7.40	7.23	7.14	7.09	7.06	7.03	7.01	6.99	6.93	6.90	6.88
7	6.28	6.24	6.21	6.18	6.16	5.99	5.91	5.86	5.82	5.80	5.78	5.75	5.70	5.67	5.65
8	5.48	5.44	5.41	5.38	5.36	5.20	5.12	5.07	5.03	5.01	4.99	4.96	4.91	4.88	4.86
9	4.92	4.89	4.86	4.83	4.81	4.65	4.57	4.52	4.48	4.46	4.44	4.41	4.36	4.33	4.31
10	4.52	4.49	4.46	4.43	4.41	4.25	4.17	4.12	4.08	4.06	4.04	4.01	3.96	3.93	3.91
11	4.21	4.18	4.15	4.12	4.10	3.94	3.86	3.81	3.77	3.75	3.73	3.70	3.65	3.62	3.60
12	3.97	3.94	3.91	3.88	3.86	3.70	3.62	3.57	3.54	3.51	3.49	3.47	3.41	3.38	3.36
13	3.78	3.74	3.72	3.69	3.66	3.51	3.42	3.37	3.34	3.32	3.30	3.27	3.22	3.19	3.17
14	3.62	3.59	3.56	3.53	3.51	3.35	3.27	3.22	3.18	3.16	3.14	3.11	3.06	3.03	3.00
15	3.49	3.45	3.42	3.40	3.37	3.21	3.13	3.08	3.05	3.02	3.00	2.98	2.92	2.89	2.87
16	3.37	3.34	3.31	3.28	3.26	3.10	3.02	2.97	2.93	2.91	2.89	2.86	2.81	2.78	2.75
17	3.27	3.24	3.21	3.19	3.16	3.00	2.92	2.87	2.83	2.81	2.79	2.76	2.71	2.68	2.65
18	3.19	3.16	3.13	3.10	3.08	2.92	2.84	2.78	2.75	2.72	2.70	2.68	2.62	2.59	2.57
19	3.12	3.08	3.05	3.03	3.00	2.84	2.76	2.71	2.67	2.65	2.63	2.60	2.55	2.51	2.49
20	3.05	3.02	2.99	2.96	2.94	2.78	2.69	2.64	2.61	2.58	2.56	2.54	2.48	2.44	2.42
21	2.99	2.96	2.93	2.90	2.88	2.72	2.64	2.58	2.55	2.52	2.50	2.48	2.42	2.38	2.36
22	2.94	2.91	2.88	2.85	2.83	2.67	2.58	2.53	2.50	2.47	2.45	2.42	2.36	2.33	2.31
23	2.89	2.86	2.83	2.80	2.78	2.62	2.54	2.48	2.45	2.42	2.40	2.37	2.32	2.28	2.26
24	2.85	2.82	2.79	2.76	2.74	2.58	2.49	2.44	2.40	2.38	2.36	2.33	2.27	2.24	2.21
25	2.81	2.78	2.75	2.72	2.70	2.54	2.45	2.40	2.36	2.34	2.32	2.29	2.23	2.19	2.17
26	2.78	2.75	2.72	2.69	2.66	2.50	2.42	2.36	2.33	2.30	2.28	2.25	2.19	2.16	2.13
27	2.75	2.71	2.68	2.66	2.63	2.47	2.38	2.33	2.29	2.27	2.25	2.22	2.16	2.12	2.10
28	2.72	2.68	2.65	2.63	2.60	2.44	2.35	2.30	2.26	2.24	2.22	2.19	2.13	2.09	2.06
29	2.69	2.66	2.63	2.60	2.57	2.41	2.33	2.27	2.23	2.21	2.19	2.16	2.10	2.06	2.03
30	2.66	2.63	2.60	2.57	2.55	2.39	2.30	2.25	2.21	2.18	2.16	2.13	2.07	2.03	2.01
40	2.48	2.45	2.42	2.39	2.37	2.20	2.11	2.06	2.02	1.99	1.97	1.94	1.87	1.85	1.80
50	2.38	2.35	2.32	2.29	2.27	2.10	2.01	1.95	1.91	1.88	1.86	1.82	1.76	1.71	1.68
60	2.31	2.28	2.25	2.22	2.20	2.03	1.94	1.88	1.84	1.81	1.78	1.75	1.68	1.63	1.60

**COMPENDIUM OF INTERNATIONAL METHODS OF ANALYSIS–OIV
Collaborative Study**

70	2.27	2.23	2.20	2.18	2.15	1.98	1.89	1.83	1.78	1.75	1.73	1.70	1.62	1.57	1.54
80	2.23	2.20	2.17	2.14	2.12	1.94	1.85	1.79	1.75	1.71	1.69	1.65	1.58	1.53	1.49
90	2.21	2.17	2.14	2.11	2.09	1.92	1.82	1.76	1.72	1.68	1.66	1.62	1.55	1.50	1.46
100	2.19	2.15	2.12	2.09	2.07	1.89	1.80	1.74	1.69	1.66	1.63	1.60	1.52	1.47	1.43
200	2.09	2.06	2.03	2.00	1.97	1.79	1.69	1.63	1.58	1.55	1.52	1.48	1.39	1.33	1.28
500	2.04	2.00	1.97	1.94	1.92	1.74	1.63	1.56	1.52	1.48	1.45	1.41	1.31	1.23	1.16
∞	2.00	1.97	1.93	1.90	1.88	1.70	1.59	1.52	1.47	1.43	1.40	1.36	1.25	1.15	1.00

Table 5 – Critical values for the Dixon test

Test criteria	Critical values		
	<i>m</i>	95%	99%
$Q_{10} = \frac{Z(2) - Z(1)}{Z(H) - Z(1)} \text{ ou } \frac{Z(H) - Z(H-1)}{Z(H) - Z(1)}$ The greater of the two values	3	0,970	0,994
	4	0,829	0,926
	5	0,710	0,821
	6	0,628	0,740
	7	0,569	0,680
$Q_{11} = \frac{Z(2) - Z(1)}{Z(H-1) - Z(1)} \text{ ou } \frac{Z(H) - Z(H-1)}{Z(H) - Z(2)}$ The greater of the two values	8	0,608	0,717
	9	0,564	0,672
	10	0,530	0,635
	11	0,502	0,605
	12	0,479	0,579
$Q_{22} = \frac{Z(3) - Z(1)}{Z(H-2) - Z(1)} \text{ ou } \frac{Z(H) - Z(H-2)}{Z(H) - Z(3)}$ The greater of the two values	13	0,611	0,697
	14	0,586	0,670
	15	0,565	0,647
	16	0,546	0,627
	17	0,529	0,610
	18	0,514	0,594
	19	0,501	0,580
	20	0,489	0,567
	21	0,478	0,555
	22	0,468	0,544
	23	0,459	0,535
	24	0,451	0,526
	25	0,443	0,517
	26	0,436	0,510
	27	0,429	0,502
	28	0,423	0,495
	29	0,417	0,489
	30	0,412	0,483
	31	0,407	0,477
	32	0,402	0,472
	33	0,397	0,467
	34	0,393	0,462
	35	0,388	0,458
	36	0,384	0,454
	37	0,381	0,450
	38	0,377	0,446
	39	0,374	0,442

**COMPENDIUM OF INTERNATIONAL METHODS OF ANALYSIS–OIV
Collaborative Study**

	40	0,371	0,438
--	----	-------	-------

Table 6 – Results of the collaborative study

Lab n°	Analysis									Sample				
	Individual values x_i									n_i	x_i	s_i	s_i^2	
	1	2	3	4	5	6	7	8						
1	548	556	558	553	542					5	551	6,47	41,8	
2	300	299	304	308	300					5	302	3,83	14,7	$x_i < x$
3	567	558	563	532*	560	560	563	567		7	563	3,51	12,3	
4	557	550	555	560	551					5	555	4,16	17,3	
5	569	575	565	560	572					5	568	5,89	34,7	
-6	550	546	549	557	588	570	576	568		8	563	14,92	222,6	$s_i > s_i$
7	557	560	560	552	547					5	555	5,63	31,7	
8	548	543	560	551	548					5	550	6,28	39,5	
9	558	563	551	555	560					5	556	5,63	31,7	
10	554	559	551	545	557					5	553	5,5	30,2	

Statistical Figures:

Bartlett Test:

Within laboratory: $s_1 = \pm 5.37$ $f_{1=34}$

$PB = 3.16 < 15.51$ (95%; $f = 8$)

Between laboratory: $s_z = \pm 13.97$ $f_z = 7$

Analysis of variance:

$s_r = \pm 5.37$ $r = 15$ $s_R = \pm 7.78$ $R = 22$ $PF = 6.76 > 3.21$ (99%; $f_1 = 7$; $f_2 = 34$)

Reliability of analytical results

(Resolution OENO 5/99)

Data concerning the reliability of analytical methods, as determined by collaborative studies, are applicable in the following cases:

- 1) Verifying the results obtained by a laboratory with a reference method
- 2) Evaluating analytical results which indicate a legal limit has been exceeded
- 3) Comparing results obtained by two or more laboratories and comparing those results with a reference value
- 4) Evaluating results obtained from a non-validated method

1) VERIFICATION OF THE ACCEPTABILITY OF RESULTS OBTAINED WITH A REFERENCE METHOD

The validity of analytical results depends on the following:

- the laboratory should perform all analyses within the framework of an appropriate quality control system which includes the organization, responsibilities, procedures, etc.
- as part of the quality control system, the laboratory should operate according to an internal Quality Control Procedure
- results should be obtained in accordance with the acceptability criteria described in the internal Quality Control Procedure

Internal quality control shall be established in accordance with internationally recognized standards, such those of the IUPAC document titled, "Harmonized Guidelines for Internal Quality Control in Analytical Laboratories."

Internal Quality Control implies an analysis of the reference material.

Reference samples should consist of a template of the samples to be analyzed and should contain an appropriate, known concentration of the substance analyzed which is similar to that found in the sample.

To the extent possible, reference material shall be certified by an internationally recognized organization.

However, for many types of analysis, there are no certified reference materials. In this case, one could use, for example, material analyzed by several laboratories in a competence test and considering the average of the results to be the value assigned to the substance analyzed.

One could also prepare reference material by formulation (model solution with known components) or by adding a known quantity of the substance analyzed to a sample which does not contain (or not yet contain) the substance by means of a recovery test (dosed addition) on one of the samples to analyze.

Quality Control is assured by adding reference material to each series of samples, and analyzing these pairs (test samples and reference material). This verifies correct implementation of the method and should be independent of the analytical calibration and protocol as its goal is to verify the aforementioned.

Series means a number of samples analyzed under repeatable conditions. Internal controls serve to ensure the appropriate level of uncertainty is not exceeded.

If the analytical results are considered to be part of a normal population whose mean is m and standard deviation is s , only around 0.3% of the results will be outside the limits $m \pm 3s$. When aberrant results are obtained (outside these limits), the system is considered to be outside statistical control (unreliable data).

The control is graphically represented using Shewhart Control Graphs. To produce these graphical results, the measured values obtained from the reference material are placed on the vertical axis while the series numbers are placed on the horizontal axis. The graph also includes horizontal lines representing the mean, m , $m \pm 2$ (warning limits) and $m \pm 3$ (action limits) (Figure 1).

To estimate the standard deviation, a control should be analyzed, in pairs, in at least 12 trials. Each analytical pair shall be analyzed under repeatable conditions and randomly inserted in a sample series. Analyses will be duplicated on different days to reflect reasonable changes from one series to another. Variations can have several causes: modification of the reactants composition, instrument re-calibration and even different operators. After eliminating aberrant data using the Grubbs test, calculate the standard deviation to construct the Shewhart graphs. This standard deviation is compared to that of the

reference method. If a published precision level is not obtained for the reference method, caused should be investigated.

The precision limits of the laboratory should be periodically revised by repeating the indicated procedure.

Once the Quality Control graph is constructed, graph the results obtained from each series for the control material.

A series is considered outside statistical control if:

- I) a value is outside the action limit,
- II) the current and previous values are situated outside the attention limits even in within the action limits,
- III) nine successive values lie on the same side of the mean.

The laboratory response to "outside control" conditions is to reject the results for the series and perform tests to determine the cause, then take action to remedy the situation.

A Shewhart Control Graph can also be produced for the differences between analytical pairs in the same sample, especially when reference material does not exist. In this case, the absolute difference between two analyses of the same sample is graphed. The graph's lower line is 0 and the attention limit is $1.128S_w$ while the action limit is $3.686S_w$ where S_w = the standard deviation of a series.

This type of graph only accounts for repeatability. It should be no greater than the published repeatability limit for the method.

In the absence of control material, it sometimes becomes necessary to verify that the reproducibility limit of the reference method is not exceeded by comparing the results obtained to those of obtained by an experimental laboratory using the same sample.

Each laboratory performs two tests and the following formula is used:

$$C_r D_{95}(\bar{y}_1 - \bar{y}_2) = \sqrt[2]{R^2 - \frac{r^2}{2}}$$

$C_r D_{95}$	=	Critical difference (P=0,95)
\bar{y}_1	=	Means of 2 results obtained by lab 1
\bar{y}_2	=	Means of 2 results obtained by lab 2
R	=	Reproducibility of reference method
r	=	Repeatability of reference method

If the critical difference has been exceeded, the underlying reason is to be found and the test is to be repeated within one month.

2) EVALUATION OF ANALYTIC RESULTS INDICATING THAT A LEGAL LIMIT HAS BEEN EXCEEDED.

When analytical results indicated that a legal limit has been exceeded, the following procedure should be followed:

- 1) In the case of an individual result, conduct a second test under repeatable conditions. If it is not possible to conduct a second test under repeatable conditions, conduct a double analysis under repeatable conditions and use these data to evaluate the critical difference.
- 2) Determine the absolute value of the difference between the mean of the results obtained under repeatable conditions and the legal limit. An absolute value of the difference which is greater than the critical distance indicates that the sample does not fit the specifications.

Critical difference is calculated by the formula:

$$C_r D_{95}(\bar{y} - m_0) = \frac{1}{\sqrt[2]{2}} \sqrt[2]{R^2 - r^2 \frac{n-1}{n}}$$

- \bar{y} = Mean of results obtained
- m_0 = Limit
- n = Number of analyses
- R = reproducibility
- r = repeatability

In other words, this is a maximal limit where the average of the results obtained should not be greater than:

$$m_0 + C_r D_{95}(y - m_0)$$

If the limit is a minimum, the average of the results obtained should not be less than:

$$m_0 - C_r D_{95}(y - m_0)$$

3) COMPARING RESULTS OBTAINED USING TWO OR MORE LABORATORIES AND COMPARING THESE RESULTS TO A REFERENCE VALUE

To determine whether or not data originating in two laboratories are in agreement, calculate the absolute difference between the two results and compare to the critical difference:

OIV-MA-AS1-08 : $C_r D_{95}(\bar{y}_1 - \bar{y}_2) = \sqrt[2]{R^2 - r^2 \left(1 - \frac{1}{2n_1} - \frac{1}{2n_2}\right)}$ 4

\bar{y}_1	=	Mean of 2 results obtained by lab 1
\bar{y}_2	=	Mean of 2 results obtained by lab 2
n_1	=	number of analyses in lab 1 sample
n_2	=	number of analyses in lab 2 sample
R	=	Reproducibility of reference method
r	=	Repeatability of reference method

If the result is the average of two tests, the equation can be simplified to:

$$C_r D_{95}(\bar{y}_1 - \bar{y}_2) = \sqrt[2]{R^2 - \frac{r^2}{2}}$$

If the data are individual results, the critical difference is R.

If the critical difference is not exceeded, the conclusion is that the results of the two laboratories are in agreement.

Comparing results obtained by several laboratories with a reference value:

Suppose p laboratories have made n_1 determinations, whose mean for each laboratory is \bar{y}_1 and whose total mean is:

$$\bar{y} = \frac{1}{p} \sum \bar{y}_i$$

The mean of all laboratories is compared with the reference value. If the absolute difference exceeds the critical difference, as calculated using the following formula, we conclude the results are not in agreement with the reference value:

$$C_r D_{95}(\bar{y} - m_0) = \frac{1}{\sqrt[2]{2p}} \sqrt[2]{R^2 - r^2 \left(1 - \frac{1}{p} \sum \frac{1}{n_i}\right)}$$

$C_r D_{95}$ = Critical difference, calculated as indicated in point 2, for the reference method.

For example, the reference value can be the value assigned to a reference material or the value obtained by the same laboratory or by a different laboratory with a different method.

4) EVALUATING ANALYTICAL RESULTS OBTAINED USING NON-VALIDATED METHODS

A provisional reproducibility value can be assigned to a non-validated method by comparing it to that of a second laboratory:

$$R_{prov} = \sqrt[3]{(\bar{y}_1 - \bar{y}_2)^2 + \frac{r^2}{2}}$$

- \bar{y}_1 = Mean of 2 results obtained by lab 1
 \bar{y}_2 = Mean of 2 results obtained by lab 2
 r = Repeatability of reference method

Provisional reproducibility can be used to calculate critical difference.

If provisional reproducibility is less than twice the value of repeatability, it should be set to 2r.

A reproducibility value greater than three times repeatability or twice the value calculated using the Horwitz equation is not acceptable.

Horwitz equation:

$$RSD_R \% = 2^{1-0,5\log_{10}C}$$

RSD_R % = Standard deviation for reproducibility
(expressed as a percentage of the mean)

C = concentration, expressed as a decimal fraction (for example, 10g/100g = 0.1)

This equation was empirically obtained from more than 3000 collaborative studies including a diverse group of analyzed substances, matrices and measurement techniques. In the absence of other information, RSD_R values that are lower or equal to the RSD_R values calculated using the Horwitz equation can be considered acceptable.

RSD_R values calculated by the Horwitz equation:

Concentration	RSD_R %
10 ⁻⁹	45
10 ⁻⁸	32
10 ⁻⁷	23
10 ⁻⁶	16
10 ⁻⁵	11
10 ⁻⁴	8
10 ⁻³	5,6
10 ⁻²	4
10 ⁻¹	2,8
1	2

If the result obtained using a non-validated method is close to the limit specified by legislation, the decision on the limit shall be decided as follows (for upper limits):

$$S = m_0 + \{(R_{\text{rout}}/R_{\text{ref}})-1\} \times C_r D_{95}$$

and, for lower limits,

$$S = m_0 - \{(R_{\text{rout}}/R_{\text{ref}})-1\} \times C_r D_{95}$$

S = decision limit

m₀ = legal limit

R_{rout} = provisional reproducibility for non-validated method

R_{ref} = reproducibility for reference method

C_rD₉₅ = critical difference, calculated as indicated in point 2, for the reference method

The result which exceeds the decision limit should be replaced with a final result obtained using the reference method.

Critical differences for probability levels other than 95%

COMPENDIUM OF INTERNATIONAL METHODS OF ANALYSIS- OIV
Reliability of Analytical Methods

This difference can be determined by multiplying the critical differences at the 95% level by the coefficients shown in Table 1.

Table 1 - Multiplicative coefficients allowing the calculation of critical differences for probability levels other than 95%

Probability level P	Multiplicative coefficient
90	0,82
95	1,00
98	1,16
99	1,29
99,5	1,40

SHEWHART CONTROL GRAPH

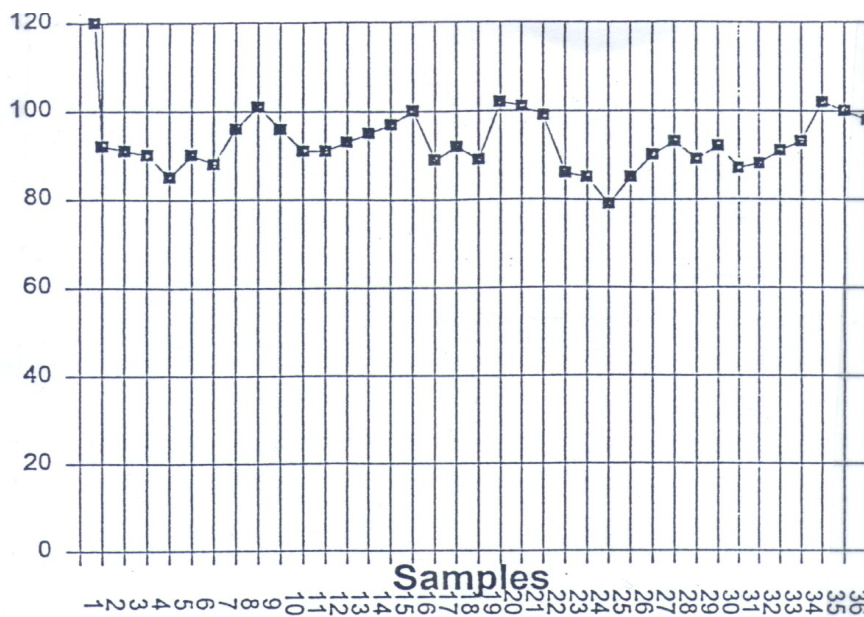

BIBLIOGRAPHY

- "Harmonized Guidelines for Internal Quality Control in Analytical Chemistry Laboratories". IUPAC. Pure and App. Chem. Vol 67, nº 4, 649-666, 1995
- "Shewhart Control Charts" ISO 8258. 1991.
- "Precision of test methods - Determination of repeatability and reproducibility for a standard test method by inter-laboratory tests". ISO 5725, 1994.
- "Draft Commission Regulation of establishing rules for the application of reference and routine methods for the analysis and quality evaluation of milk and milk products". Commission of the European Communities, 1995.
- "Harmonized protocols for the adoption of standardized analytical methods and for the presentation of their performance characteristics". IUPAC. Pure an App. Chem., Vol. 62, nº 1, 149-162. 1990.

Protocol for the design, conducts and interpretation of collaborative studies

(Resolution OENO 6/2000)

INTRODUCTION

After a number of meetings and workshops, a group of representatives from 27 organizations adopted by consensus a "Protocol for the design, conducts and interpretation of collaborative studies" which was published in Pure & Appl. Chem. 60, 855-864, 1995. A number of organizations have accepted and used this protocol. As a result of their experience and the recommendations of the Codex Committee on Methods of Analysis and Sampling (Joint FAO/WHO Food Standards Programme, Report of the Eighteenth Session, 9-13 November, 1992; FAO, Rome Italy, ALINORM 93/23, Sections 34-39), three minor revisions were recommended for incorporation into the original protocol. These are: (1) Delete the double split level design because the interaction term it generates depends upon the choice of levels and if it is statistically significant, the interaction cannot be physically interpreted. (2) Amplify the definition of "material". (3) Change the outlier removal criterion from 1% to 2.5%.

The revised protocol incorporating the changes is reproduced below. Some minor editorial revisions to improve readability have also been made. The vocabulary and definitions of the document 'Nomenclature of Interlaboratory Studies (Recommendations 1994)' [published in Pure Appl Chem., 66, 1903-1911 (1994)] has been incorporated into this revision, as well as utilizing, as far as possible, the appropriate terms of the International Organization for Standardization (ISO), modified to be applicable to analytical chemistry.

PROTOCOL

1 Preliminary work

Method-performance (collaborative) studies require considerable effort and should be conducted only on methods that have

received adequate prior testing. Such within-laboratory testing should include, as applicable, information on the following:

1.1 Preliminary estimates of precision

Estimates of the total within-laboratory standard deviation of the analytical results over the concentration range of interest as a minimum at the upper and lower limits of the concentration range, with particular emphasis on any standard or specification value.

NOTE 1: The total within-laboratory standard deviation is a more inclusive measure of imprecision than the ISO repeatability standard deviation, §3.3 below. This standard deviation is the largest of the within-laboratory type precision variables to be expected from the performance of a method; it includes at least variability from different days and preferably from different calibration curves. It includes between-run (between-batch) as well as within-run (within-batch) variations. In this respect it can be considered as a measure of within-laboratory reproducibility. Unless this value is well within acceptable limits, it cannot be expected that the between-laboratory standard deviation (reproducibility standard deviation) will be any better. This precision term is not estimated from the minimum study described in this protocol.

NOTE 2: The total within-laboratory standard deviation may also be estimated from ruggedness trials that indicate how tightly controlled the experimental factors must be and what their permissible ranges are. These experimentally determined ranges should be incorporated into the description of the method.

1.2 Systematic error (bias)

Estimates of the systematic error of the analytical results over the concentration range and in the substances of interest, as a minimum at the upper and lower limits of the concentration range, with particular emphasis on any standard or specification value.

The results obtained by applying the method to relevant reference materials should be noted.

1.3 Recoveries

The recoveries of "spikes" added to real materials and to extracts, digests, or other treated solutions thereof.

1.4 Applicability

The ability of the method to identify and measure the physical and chemical forms of the analyte likely to be present in the materials, with due regard to matrix effects.

1.5 Interference

The effect of other constituents that are likely to be present at appreciable concentrations in matrices of interest and which may interfere in the determination.

1.6 Method comparison

The results of comparison of the application of the method with existing tested methods intended for similar purposes.

1.7 Calibration Procedures

The procedures specified for calibration and for blank correction must not introduce important bias into the results.

1.8 Method description

The method must be clearly and unambiguously written.

1.9 Significant figures

The initiating laboratory should indicate the number of significant figures to be reported, based on the output of the measuring instrument.

NOTE: In making statistical calculations from the reported data, the full power of the calculator or computer is to be used with no rounding or truncating until the final reported mean and standard deviations are achieved. At this point the standard deviations are rounded to 2 significant figures and the means and related standard deviations are rounded to accommodate the significant figures of the standard deviation. For example, if $S_R = 0.012$, c is reported as 0.147, not as 0.1473 or 0.15, and RSD_R is reported

as 8.2%. (Symbols are defined in Appendix L) If standard deviation calculations must be conducted manually in steps, with the transfer of intermediate results, the number of significant figures to be retained for squared numbers should be at least 2 times the number of figures in the data plus 1.

2. Design of the method-performance study

2.1 Number of materials

For a single type of substance, at least 5 materials (test samples) must be used; only when a single level specification is involved for a single matrix may this minimum required number of materials to be reduced to 3. For this design parameter, the two portions of a split level and the two individual portions of blind replicates per laboratory are considered as a single material.

NOTE 1: A material is an 'analyte/matrix/concentration' combination to which the method-performance parameters apply. This parameter determines the applicability of a method. For application to a number of different substances, a sufficient number of matrices and levels should be chosen to include potential interferences and the concentration of typical use.

NOTE 2: The 2 or more test samples of blind or open replicates statistically, are a single material (they are not independent).

NOTE 3: A single split level (Youden pair) statistically analyzed as a pair is a single material; if analyzed statistically and reported as single test samples, they are 2 materials. In addition, the pair can be used to calculate the within-laboratory standard deviation, s_r as

$$s_r = \sqrt{(\sum d_i^2) / 2n} \quad (\text{for duplicates, blind or open}),$$
$$s_r = \sqrt{(\sum(d_i^2) / 2(n - 1))} \quad (\text{for Youden pairs}),$$

where d_i , the difference between the 2 individual values from the split level for each laboratory and n is the number of laboratories. In this special case, S_R , the among laboratories standard deviation, is merely the average of the two S_R values calculated from the individual components of the split level, and it is used only as a check of the calculations.

NOTE 4: The blank or negative control may be a material or not depending on the usual purpose of the analysis. For example, in trace analysis, where very low levels (near the limit of

quantitation) are often sought, the blanks are considered as materials and are necessary to determine certain 'limits of measurement.' However, if the blank is merely a procedural control in macro analysis (e.g., fat in cheese), it would not be considered a material.

2.2 Number of laboratories

At least 8 laboratories must report results for each material; only when it is impossible to obtain this number (e.g., very expensive instrumentation or specialized laboratories required) may the study be conducted with less, but with an absolute minimum of 5 laboratories. If the study is intended for international use, laboratories from different countries should participate. In the case of methods requiring the use of specialized instruments, the study might include the entire population of available laboratories. In such cases, "n" is used in the denominator for calculating the standard deviation instead of "(n - 1)". Subsequent entrants to the field should demonstrate the ability to perform as well as the original participant.

2.3 Number of Replicates

The repeatability precision parameters must be estimated by using one of the following sets of designs (listed in approximate order of desirability):

2.3.1 Split Level

For each level that is split and which constitutes only a single material for purposes of design and statistical analysis, use 2 nearly identical test samples that differ only slightly in analyte concentration (e.g., <1-5%). Each laboratory must analyse each test sample once and only once.

NOTE: The statistical criterion that must be met for a pair of test samples to constitute a split level is that the reproducibility standard deviation of the two parts of the single split level must be equal.

2.3.2 Combination blind replicates and split level

Use split levels for some materials and blind replicates for other materials in the same study (single values from each submitted test sample).

2.3.3 Blind replicates

For each material, use blind identical replicates, when data censoring is impossible (e.g., automatic input, calculation, and printout) non-blind identical replicates may be used.

2.3.4 Known replicates

For each material, use known replicates (2 or more analyses of test portions from the same test sample), but only when it is not practical to use one of the preceding designs.

2.3.5 Independent analyses

Use only a single test portion from each material (i.e., do not perform multiple analyses) in the study, but rectify the inability to calculate repeatability parameters by quality control parameters or other within-laboratory data obtained independently of the method-performance study.

3. Statistical analysis (See Flowchart, A.4. 1)

For the statistical analysis of the data, the required statistical procedures listed below must be performed and the results reported. Supplemental, additional procedures are not precluded.

3.1 Valid data

Only valid data should be reported and subjected to statistical treatment. Valid data are those data that would be reported as resulting from the normal performance of laboratory analyses; they are not marred by method deviations, instrument malfunctions, unexpected occurrences during performance, or by clerical, typographical and arithmetical errors.

3.2 One-way analysis of variance

One-way analysis of variance and outlier treatments must be applied separately to each material (test sample) to estimate the components of variance and repeatability and reproducibility parameters.

3.3 Initial estimation

Calculate the mean, \bar{c} (= the average of laboratory averages), repeatability relative standard deviation, RSD_r , and reproducibility relative standard deviation, RSD_R with no outliers removed, but using only valid data.

3.4 Outlier treatment

The estimated precision parameters that must also be reported are based on the initial valid data purged of all outliers flagged by

the harmonized 1994 outlier removal procedure. This procedure essentially consists of sequential application of the Cochran and Grubbs tests (at 2.5% probability (P) level, 1-tail for Cochran and 2-tail for Grubbs) until no further outliers are flagged or until a drop of 22.2% (= 219) in the original number of laboratories providing valid data would occur.

NOTE: Prompt consultation with a laboratory reporting suspect values may result in correction of mistakes or discovering conditions that lead to invalid data, 3.1.

Recognizing mistakes and invalid data per se is much preferred to relying upon statistical tests to remove deviate values.

3.4.1 Cochran test

First apply Cochran outlier test (1-tail test a $P = 2.5\%$) and remove any laboratory whose critical value exceeds the tabular value given in the table, Appendix A.3. 1, for the number of laboratories and replicates involved.

3.4.2 Grubbs tests

Apply the single value Grubbs test (2 tail) and remove any outlying laboratory. If no laboratory is flagged, then apply the pair value tests (2 tail) - - 2 at the same end and 1 value at each end, $P = 2.5\%$ overall. Remove any laboratory(ies) flagged by these tests whose critical value exceeds the tabular value given in the appropriate column of the table Appendix A.3.3. Stop removal when the next application of the test will flag as table, A outliers more that 22.2% (2 of 9) of the laboratories.

NOTE: The Grubbs tests are to be applied one material at a time to the set of replicate means from all laboratories, and not to the individual values from replicated designs because the distribution of all the values taken together is multimodal, not Caussian, i.e., their differences from the overall mean for that material are not independent.

3.4.3 Final estimation

Recalculate the parameters as in §3.3 after the laboratories flagged by the preceding procedure have been removed. If no outliers were removed by the Cochran-Grubbs sequence, terminate testing. Otherwise, reapply the Cochran-Grubbs sequence to the data purged of the flagged outliers until no further outliers are flagged or until more than a total of 22.2% (2

of 9 laboratories) would be removed in the next cycle. See flowchart A.3.4.

4. Final report

The final report should be published and should include all valid data. Other information and parameters should be reported in a format similar (with respect to the reported items) to the following, as applicable:

[x] Method-performance tests carried out at the international level in [year(s)] by [organisation] in which [y and z] laboratories participated, each performing [k] replicates, gave the following statistical results:

TABLE OF METHOD-PERFORMANCE PARAMETERS

Analyte; Results expressed in [units]

Material [Description and listed in columns across top of table in increasing order of magnitude of means]

Number of laboratories retained after eliminating outliers

Number of outlying laboratories

Code (or designation) of outlying laboratories

Number of accepted results

Mean

True or accepted value, if known

Repeatability standard deviation (S_r)

Repeatability relative standard deviation (RSD_r)

Repeatability limit, r ($2.8 \times S_r$)

Reproducibility standard deviation (S_R)

Reproducibility relative standard deviation (RSD_R)

Reproducibility limit, R ($2.8 \times S_R$)

4.1 Symbols

A set of symbols for use in reports and publications is attached as Appendix 1 (A.1.).

4.2 Definitions

A set of definitions for use in study reports and publications is attached as Appendix 2 (A.2.).

4.3 Miscellaneous

4.3.1 Recovery

Recovery of added analyte as a control on method or laboratory bias should be calculated as follows:

[Marginal] Recovery, % =

(Total analyte found - analyte originally present) x 100 / (analyte added)

Although the analyte may be expressed as either concentration or amount, the units must be the same throughout. When the quantity of analyte is determined by analysis, it must be determined in the same way throughout.

Analytical results should be reported uncorrected for recovery. Report recoveries separately.

4.3.2 When S_r is negative

By definition, S_R is greater than or equal to S_r in method-performance studies; occasionally the estimate of S_r is greater than the estimate of S_R (the average of the replicates is greater than the range of laboratory averages and the calculated S_L^2 is then negative). When this occurs, set $S_L = 0$ and $S_R = S_r$.

5. REFERENCES

Horwitz, W. (1988) Protocol for the design, conduct, and interpretation of method performance studies. Pure & Appl. Chem. 60, 855-864.

Pocklington, W.D. (1990) Harmonized protocol for the adoption of standardized analytical methods and for the presentation of their performance characteristics. Pure and Appl. Chem. 62, 149-162.

International Organization for Standardization. International Standard 5725-1986. Under revision in 6 parts; individual parts may be available from National Standards member bodies.

A. APPENDICES

APPENDIX 1. - SYMBOLS

Use the following set of symbols and terms for designating parameters developed by a method-performance study.

Mean (of laboratory averages)	\bar{x}
Standard deviations:	s (estimates)
Repeatability	S_r
'Pure' between-laboratory	S_L
Reproducibility	S_R
Variances:	S^2 (with subscripts, r, L, and R)
R)	
	$S_R^2 = S_L^2 + S_r^2$
Relative standard deviations:	RSD (with subscripts, r, L, and r)
Maximum tolerable differences (as defined by ISO 5725-1986); See A.2.4 and A.2.5)	
Repeatability limit	$r = (2.8 \times S_r)$
Reproducibility limit	$R = (2.8 \times S_R)$
Number of replicates per laboratory	k (general)
Average number of replicates per laboratory i	k_i (for a balanced design)
Number of laboratories	L
Number of materials (test samples)	m
Total number of values in a given assay (balanced design)	n (= kL for a balanced design)
Total number of values in a given study (overall balanced design)	N (= kLm for an overall balanced design)

If other symbols are used, their relationship to the recommended symbols should be explained fully.

APPENDIX 2. - DEFINITIONS

Use the following definitions. The first three definitions utilize the IUPAC document "Nomenclature of Interlaboratory Studies" (approved for publication 1994). The next two definitions are assembled from components given in ISO 3534-1:1993. All test results are assumed to be independent, i.e., 'obtained in a manner not influenced by any previous result on the same or similar test object. Quantitative measures of precision depend critically on the stipulated conditions. Repeatability and reproducibility conditions are particular sets of extreme stipulated conditions.'

A.2.1 Method-performance studies

An interlaboratory study in which all laboratories follow the same written protocol and use the same test method to measure a quantity in sets of identical test items [test samples, materials]. The reported results are used to estimate the performance characteristics of the method. Usually these characteristics are within-laboratory and among-laboratories precision, and when necessary and possible, other pertinent characteristics such as systematic error, recovery, internal quality control parameters, sensitivity, limit of determination, and applicability.

A.2.2. Laboratory-performance study

An interlaboratory study that consists of one or more analyses or measurements by a group of laboratories on one or more homogeneous, stable test items, by the method selected or used by each laboratory. The reported results are compared with those of other laboratories or with the known or assigned reference value, usually with the objective of evaluating or improving laboratory performance.

A.2.3 Material certification stud

An interlaboratory study that assigns a reference value ('true value') to a quantity (concentration or property) in the test item, usually with a stated uncertainty.

A.2.4 Repeatability limit (r)

When the mean of the values obtained from two single determinations with the same method on identical test items in the same laboratory by the same operator using the same equipment within short intervals of time, lies within the range of

the mean values cited in the Final Report, 4.0, the absolute difference between the two test results obtained should be less than or equal to the repeatability limit (r) [$= 2.8 \times s_r$] that can generally be inferred by linear interpolation of s_r from the Report.

NOTE: This definition, and the corresponding definition for reproducibility limit, has been assembled from five cascading terms and expanded to permit application by interpolation to a test item whose mean is not the same as that used to establish the original parameters, which is the usual case in applying these definitions. The term 'repeatability [and reproducibility] limit' is applied specifically to a probability of 95% and is taken as $2.8 \times s_r$, [or SRI. The general term for this statistical concept applied to any measure of location (e.g., median) and with other probabilities (e.g., 99%) is "repeatability [and reproducibility] critical difference".

A.2.5 Reproducibility limit (R)

When the mean of the values obtained from two single determinations with the same method on identical test items in different laboratories with different operators using different equipment, lies within the range of the mean values cited in the Final Report, 4.0, the absolute difference between the two test results obtained should be less than or equal to the reproducibility limit (R) [$= 2.8 \times s_R$] that can generally be inferred by linear interpolation of s_R from the Report.

NOTE 1: When the results of the interlaboratory test make it possible, the value of r and R can be indicated as a relative value (e.g., as a percentage of the determined mean value) as an alternative to the absolute value.

NOTE 2: When the final reported result in the study is an average derived from more than a single value, i.e., k is greater than 1, the value for R must be adjusted according to the following formula before using R to compare the results of a single routine analyses between two laboratories.

$$R' = (R^2 + r^2 (1 - [1/k]))^{1/2}$$

Similar adjustments must be made for replicate results constituting the final values for s_R and $RSD_{R'}$, if these will be the reported parameters used for quality control purposes.

NOTE 3: The repeatability limit, r , may be interpreted as the amount within which two determinations should agree with each other within a laboratory 95% of the time. The reproducibility limit, R , may be interpreted as the amount within which two separate determinations conducted in different laboratories should agree with each other 95% of the time.

NOTE 4: Estimates Of S_R can be obtained only from a planned, organized method performance study; estimates of S_r can be obtained from routine work within a laboratory by use of control charts. For occasional analyses, in the absence of control charts, within-laboratory precision may be approximated as one half S_R (Pure and Appl. Chem., 62, 149-162 (1990) , Sec. L3, Note.).

A.2.6 One-way analysis of variance

One-way analysis of variance is the statistical procedure for obtaining the estimates of within laboratory and between-laboratory variability on a material-by-material basis. Examples of the calculations for the single level and single-split-level designs can be found in ISO 5725-1986.

APPENDIX 3. - CRITICAL VALUES

A.3.1 Critical values for the Cochran maximum variance ratio at the 2.5% (1 -tail) rejection level, expressed as the percentage the highest variance is of the total variance; r = number of replicates.

No. of Labs	r=2	r = 3	r=4	r = 5	r = 6
4	94.3	81.0	72.5	65.4	62.5
5	88.6	72.6	64.6	58.1	53.9
6	83.2	65.8	58.3	52.2	47.3
7	78.2	60.2	52.2	47.3	42.3
8	73.6	55.6	47.4	43.0	38.5
9	69.3	51.8	43.3	39.3	35.3
10	65.5	48.6	39.9	36.2	32.6
11	62.2	45.8	37.2	33.6	30.3
12	59.2	43.1	35.0	31.3	28.3
13	56.4	40.5	33.2	29.2	26.5
14	53.8	38.3	31.5	27.3	25.0
15	51.5	36.4	29.9	25.7	23.7
16	49.5	34.7	28.4	24.4	22.0
17	47.8	33.2	27.1	23.3	21.2
18	46.0	31.8	25.9	22.4	20.4
19	44.3	30.5	24.8	21.5	19.5
20	42.8	29.3	23.8	20.7	18.7
21	41.5	28.2	22.9	19.9	18.0
22	40.3	27.2	22.0	19.2	17.3
23	39.1	26.3	21.2	18.5	16.6
24	37.9	25.5	20.5	17.8	16.0
25	36.7	24.8	19.9	17.2	15.5
26	35.5	24.1	19.3	16.6	15.0
27	34.5	23.4	18.7	16.1	14.5
28	33.7	22.7	18.1	15.7	14.1
29	33.1	22.1	17.5	15.3	13.7
30	32.5	21.6	16.9	14.9	13.3
35	29.3	19.5	15.3	12.9	11.6
40	26.0	17.0	13.5	11.6	10.2
50	21.6	14.3	11.4	9.7	8.6

Tables A.3.1 and A.3.3 were calculated by R. Albert (October, 1993) by computer simulation involving several runs of approximately 7000 cycles each for each value, and then smoothed. Although Table A.3.1 is strictly applicable only to a balanced design (same number of replicates from all laboratories), it can be applied to an unbalanced design without too much error, if there are only a few deviations.

**COMPENDIUM OF INTERNATIONAL METHODS OF ANALYSIS – OIV
Protocol for collaborative studies**

A.3.2 Calculation of Cochran maximum variance outlier ratio

Compute the within-laboratory variance for each laboratory and divide the largest of these variances by the sum of the all of the variances and multiply by 100. The resulting quotient is the Cochran statistic which indicates the presence of a removable outlier if this quotient exceed the critical value listed above in the Cochran table for the number of replicates and laboratories specified.

A.3.3 Critical values for the Grubbs extreme deviation outlier tests at the 2.5% (2-tail), 1.25% (1tail) rejection level, expressed as the percent reduction in standard deviations caused by the removal of the suspect value(s).

No. of labs	One highest or lowest	Two highest or two lowest	One highest and one lowest
4	86.1	98.9	99.1
5	73.5	90.9	92.7
6	64.0	81.3	84.0
7	57.0	73.1	76.2
8	51.4	66.5	69.6
9	46.8	61.0	64.1
10	42.8	56.4	59.5
11	39.3	52.5	55.5
12	36.3	49.1	52.1
13	33.8	46.1	49.1
14	31.7	43.5	46.5
15	29.9	41.2	44.1
16	28.3	39.2	42.0
17	26.9	37.4	40.1
18	25.7	35.9	38.4
19	24.6	34.5	36.9
20	23.6	33.2	35.4
21	22.7	31.9	34.0
22	21.9	30.7	32.8
23	21.2	29.7	31.8
24	20.5	28.8	30.8
25	19.8	28.0	29.8
26	19.1	27.1	28.9
27	18.4	26.2	28.1
28	17.8	25.4	27.3
29	17.4	24.7	26.6
30	17.1	24.1	26.0

COMPENDIUM OF INTERNATIONAL METHODS OF ANALYSIS – OIV
Protocol for collaborative studies

40	13.3	19.1	20.5
50	11.1	16.2	17.3

A.3.4 Calculation of the Grubbs test values

To calculate the single Grubbs test statistic, compute the average for each laboratory and then calculate the standard deviation (M) of these L averages (designate as the original s). Calculate the SD of the set of averages with the highest average removed (SH); calculate the SD of the set of averages with the lowest average removed (SL). Then calculate the percentage decrease in SD for both as follows:

$$100 \times [1 - (sL/s)] \text{ and } 100 \times [1 - (sH/s)].$$

The higher of these two percentage decreases is the single Grubbs test statistic, which signals the presence of an outlier to be omitted at the $P = 2.5\%$ level, 2-tail, if it exceeds the critical value listed in the single value column, Column 2, of Table A.3.3, for the number of laboratory averages used to calculate the original s.

To calculate the paired Grubbs test statistics, calculate the percentage decrease in standard deviation obtained by dropping the two highest averages and also by dropping the two lowest averages, as above. Compare the higher of the percentage changes in standard deviation with the tabular values in column 3 and proceed with (1) or (2): (1) If the tabular value is exceeded, remove the responsible pair. Repeat the cycle again, starting at the beginning with the Cochran extreme variance test again, the Grubbs extreme value test, and the paired Grubbs extreme value test. (2) If no further values are removed, then calculate the percentage change in standard deviation obtained by dropping both the highest extreme value and the lowest extreme value together, and compare with the tabular values in the last column of A.3.3. If the tabular value is exceeded, remove the high-low pair of averages, and start the cycle again with the Cochran test until no further values are removed. In all cases, stop outlier testing when more than 22.2% (2/9) of the averages are removed.

APPENDIX 4

A.4.1. Flowchart for outlier removal

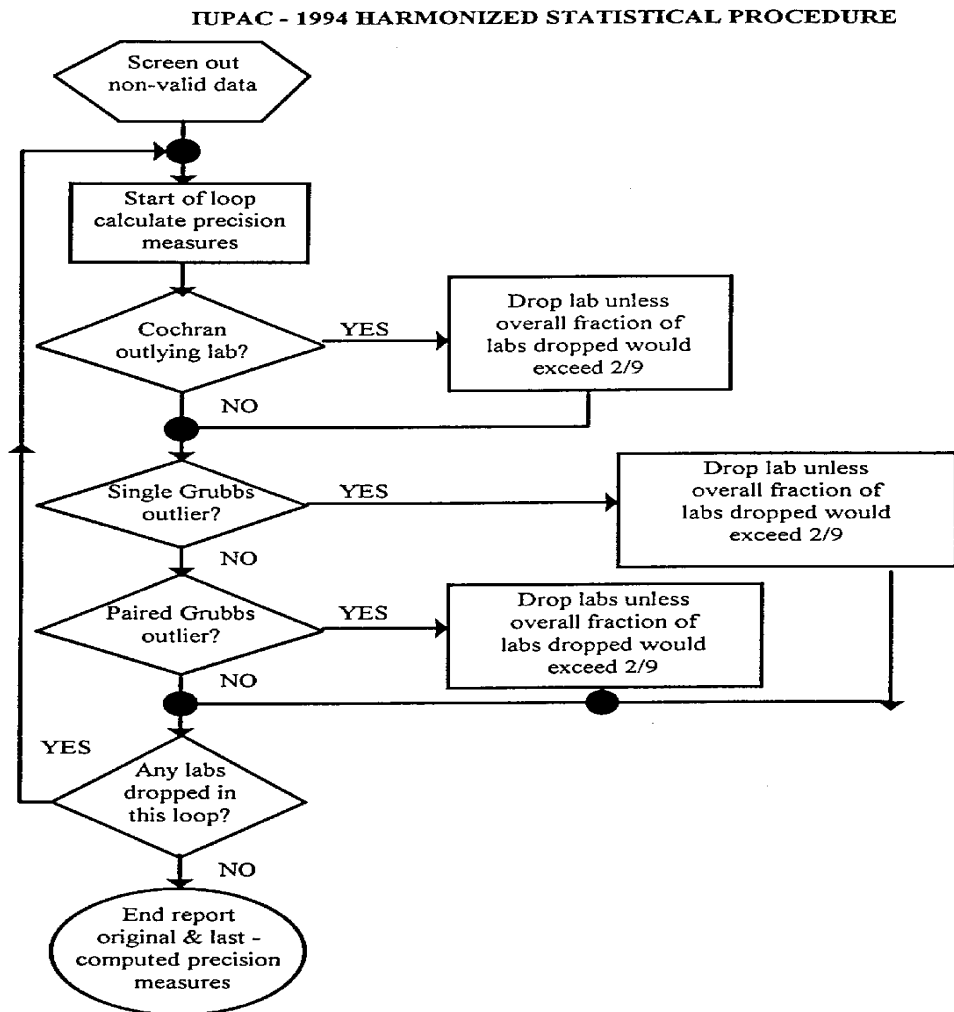

Estimation of the detection and quantification limits of a method of analysis

(Resolution OENO 7/2000)

1 - Purpose: to establish the detection and quantification limits of a method

N.B. : The proposed calculation procedure sets « detection and quantification limiting » values with respect to the instrumental response. For a given method, the final calculation of these values must take cognizance of factors arising from the preparation of the sample.

2 - Definitions

- Detection limit: the smallest concentration or proportion of the analyzed substance that can be detected with an acceptable level of uncertainty, but that is not quantified under the experimental conditions described in the method
- Quantification limit: the smallest concentration or proportion of the analyzed substance that can be quantified with an acceptable level of uncertainty, under the experimental conditions described in the method.

3 - Logic Diagram for Decision-Making

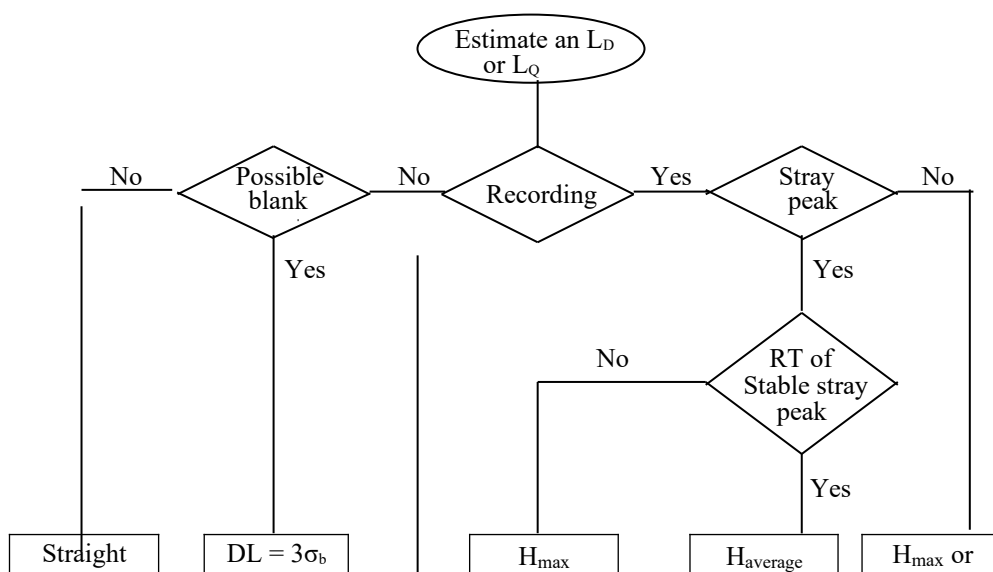

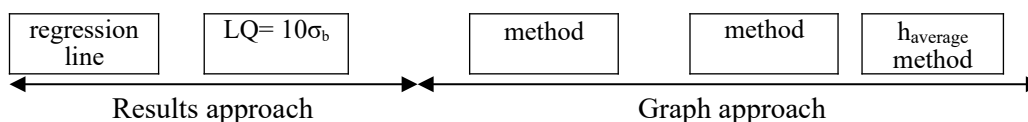

4 - Methodology

4.1 "Results" approach

When the analytical method produces no recorded graph, but only numerical values (i.e., colorimetry), the detection limit (L_D) and the quantification limit (L_Q) are estimated using one of the two following methods.

4.1.1 - Method 1:

Directly read n measurements (analyte quantity or response) of separate analytic « blank » samples that contain all of the constituents, with the exception of the substance to be tested for.

$$L_D = m_{\text{blank}} + 3S_{\text{blank}} \text{ and}$$

$$L_Q = m_{\text{blank}} + 10S_{\text{blank}}$$

where m_{blank} and S_{blank} are the mean and standard deviation for n measurements.

Note: A multiplication factor of 3 corresponds to a 0.13% chance of concluding that the substance sought is present, when, in fact, it is lacking. 10 corresponds to a 0.5% chance.

4.1.2 - Method 2:

Using the straight calibration line: $Y = a + bX$

The detection limit is the smallest concentration of a substance that can be distinguished from the blank, with a 0.13% risk of retaining samples containing nothing ; in other words, the value beginning at which a statistical test comparing the response to 0 becomes significant with an error level α of 0.13%. Hence:

$$Y_{DL} = a + 3S_a$$

$$X_{DL} = (a + 3S_a)/b$$

Where S_a is the standard deviation on the ordinate at the origin of the straight regression line. The logic is the same for L_Q , where the multiplication factor is 10 (risk of 0.5%).

4.2 - "Graph" Approach

COMPENDIUM OF INTERNATIONAL METHODS OF ANALYSIS –OIV Estimation of Detection and Quantification Limit

For analytical methods which generate graphs (i.e., chromatography), the detection limit is estimated based on the ground noise of the analytic blank recording for a given sample.

$$L_D = 3 \times h \times R \text{ (associated risk is below 0.13\%)} \text{ and}$$

$$L_Q = 10 \times h \times R \text{ (associated risk is below 0.5\%)},$$

where

- h is the average or maximum amplitude of the signal window corresponding to 10 widths of the mid-height peak on either side of the retention time, as a function of stability.
- R is the quantity/signal response factor expressed as a function of the quantity of substance/height.

On each occasion, three series of three injections each are performed on test blanks at an interval of several days.

4.2.1 h_{\max} method

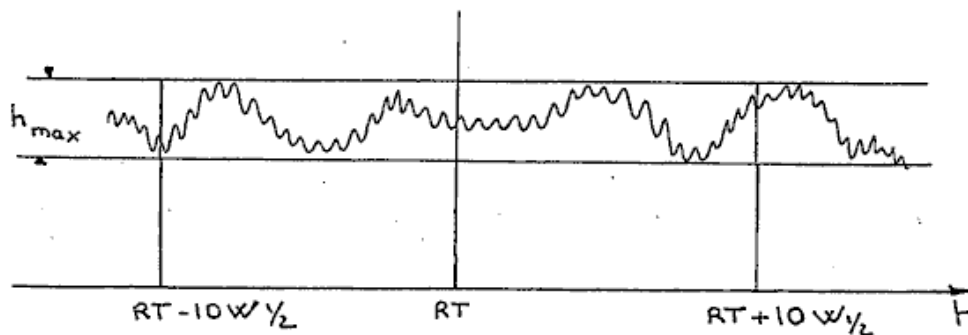

- Increase ground noise to the maximum (Fig. 1 above) ;
- center around the retention time (RT) of the product ;
- draw a window of 10 widths of the mid-height peak ($W_{1/2}$) on either side of the RT ;
- draw two parallel lines, one running through the highest point of the highest peak, the other through the base of the deepest trough ;
- evaluate height $\rightarrow h_{\max}$;
- calculate the response factor (R factor) ;
- $L_{D\max} = 3 \times h_{\max} \times R$
- $L_{Q\max} = 10 \times h_{\max} \times R$

4.2.2 h_{average} Method

COMPENDIUM OF INTERNATIONAL METHODS OF ANALYSIS –OIV
Estimation of Detection and Quantification Limit

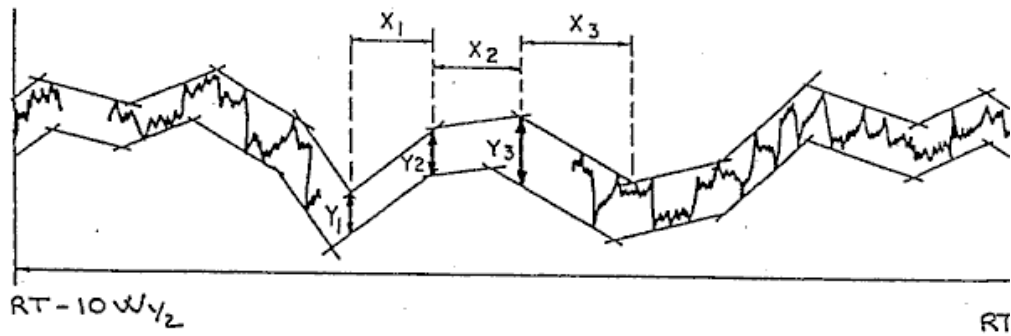

- increase the ground noise to the maximum (Fig. 2 above) ;
- center around the retention time (RT) of the product ;
- draw a window of 10 widths of the mid-height peak ($W_{1/2}$) on either side of the RT ;
- divide into 20 equal sections (x) ;
- draw two parallel lines in each block, one running through the highest point of the highest peak, the other through the base of the deepest trough ;
- measure the heights, y ;
- calculate the average ($y = h_{\text{average}}$);
- calculate the response factor (R factor);
- $L_{\text{Daverage}} = 3 \times h_{\text{average}} \times R$;
- $L_{\text{Qaverage}} = 10 \times h_{\text{average}} \times R$

These estimates can themselves be validated by injecting quantities of solute that are close to the calculated limits (Figures 3 and 4).

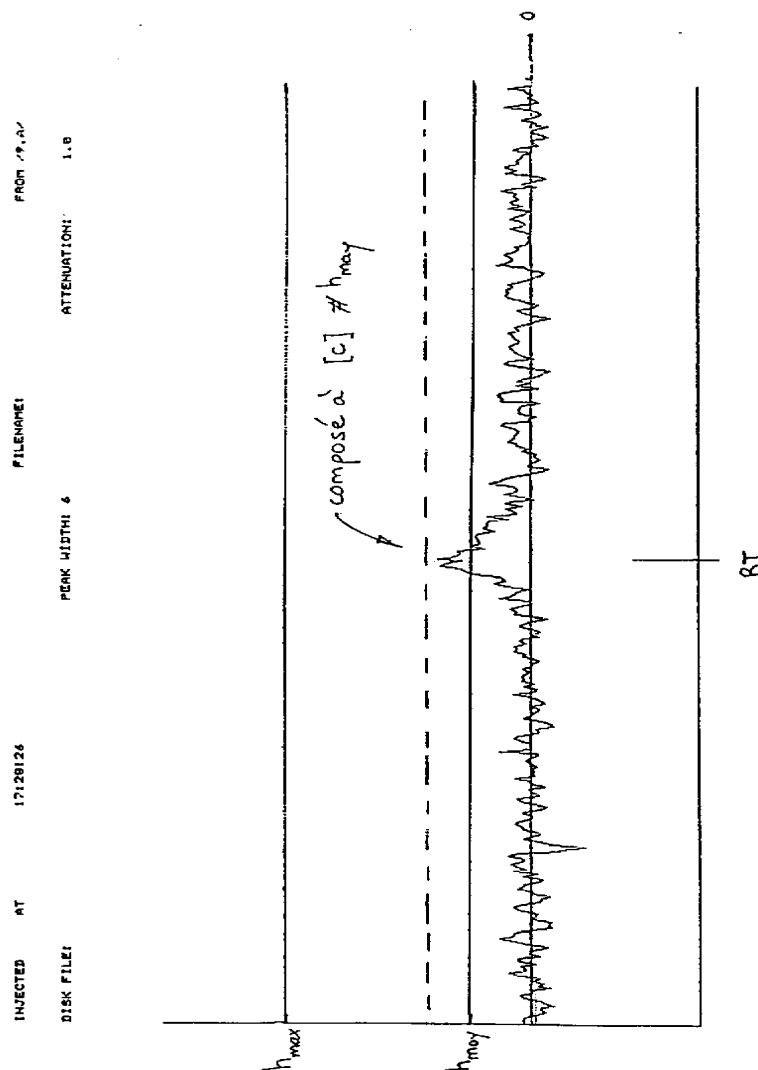

Compound at [c] # h_{max}

Figure No. 3: Validating calculations of limits.
 Concentration of the compound approaches $H_{average}$

N.B.: The dotted line corresponds to the real injected value
 however, since this figure is provided as an example, it may
 be deleted from the final text.

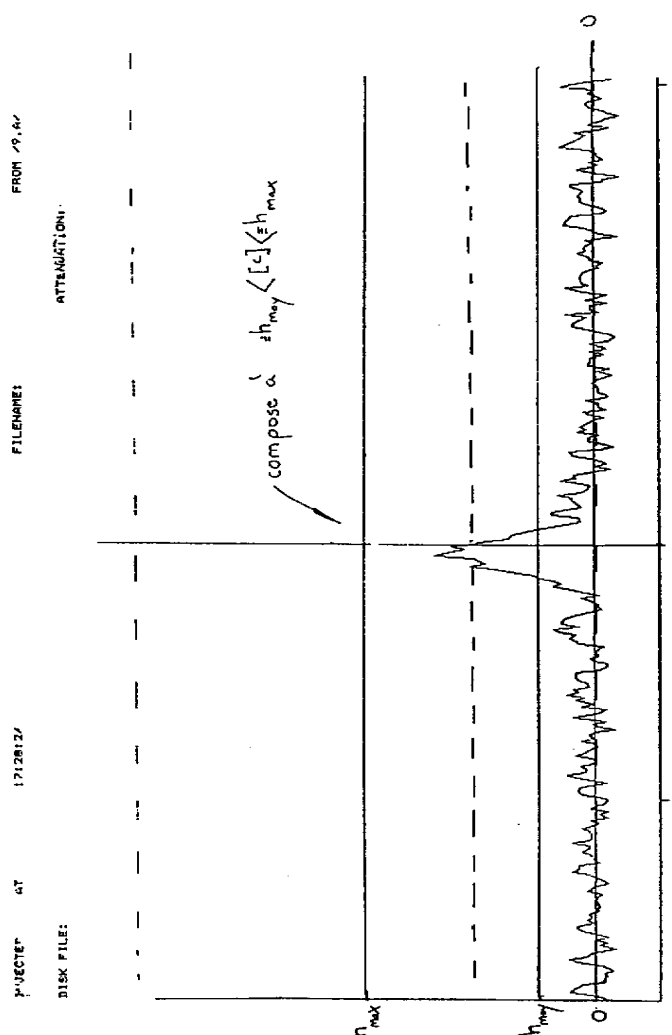

Compound at $h_{average} < [c] < \approx h_{max}$

Figure No. 4: Validating calculations of limits.

Concentration of compound between $H_{average}$ and H_{max}

N.B.: The dotted line corresponds to the real injected value; however, since this figure is provided as an example, it may be deleted from the final text.

**Harmonized guidelines for internal quality control
in analytical chemistry laboratories**

(Resolution OENO 19/2002)

CONTENTS

1. INTRODUCTION

- 1.1 Basic concepts**
- 1.2. Scope of this document**
- 1.3. Internal quality control and uncertainties**

2. DEFINITIONS

- 2.1. International definitions**
- 2.2. Definition of terms specific to this document**

3. QUALITY ASSURANCE PRACTICES AND INTERNAL QUALITY CONTROL

- 3.1. Quality assurance**
- 3.2. Choice of analytical method**
- 3.3. Quality control and aptitude tests**

4. INTERNAL QUALITY CONTROL PROCEDURES

- 4.1. Introduction**
- 4.2. General approach. Statistical control**
- 4.3. Internal quality control and fitness for purpose**
- 4.4. The nature of errors**

5. IQC AND WITHIN-RUN PRECISION

- 5.1. Precision and duplication**
- 5.2. Interpretation of duplicate data**

6. CONTROL MATERIALS IN IQC

- 6.1. Introduction**
- 6.2. The role of certified reference materials**
- 6.3. Preparation of control material**

**COMPENDIUM OF INTERNATIONAL METHODS OF ANALYSIS –OIV
Harmonized guidelines for internal quality control in analytical
chemistry laboratories**

6.4. Blank determinations

6.5. Traceability in spiking and recovery checks

7. RECOMMENDATIONS

8. CONCLUSIONS

9. REFERENCES

APPENDIX 1. SHEWHART CONTROL CHARTS

1. INTRODUCTION

1.1 Basic concept

This document sets out guidelines for the implementation of internal quality control (IQC) in analytical laboratories. IQC is one of a number of concerted measures that analytical chemists can take to ensure that the data produced in the laboratory are fit for their intended purpose. In practice, fitness for purpose is determined by a comparison of the accuracy achieved in a laboratory at a given time with a required level of accuracy. Internal quality control therefore comprises the routine practical procedures that enable the analytical chemist to accept a result or group of results as fit for purpose, or reject the results and repeat the analysis. As such, IQC is an important determinant of the quality of analytical data, and is recognised as such by accreditation agencies.

Internal quality control is undertaken by the inclusion of particular reference materials, here called "control materials", into the analytical sequence and by duplicate analysis. The control materials should, wherever possible, be representative of the test materials under consideration in respect of matrix composition, the state of physical preparation and the concentration range of the analyte. As the control materials are treated in exactly the same way as the test materials, they are regarded as surrogates that can be used to characterise the performance of the analytical system, both at a specific time and over longer intervals.

Internal quality control is a final check of the correct execution of all of the procedures (including calibration) that are prescribed in the analytical protocol and all of the other quality assurance measures that underlie good analytical practice. IQC is therefore necessarily retrospective. It is also required to be as far as possible independent of the analytical protocol, especially the calibration, that it is designed to test.

Ideally both the control materials and those used to create the calibration should be traceable to appropriate certified reference materials or a recognised empirical reference method. When this is not possible, control materials should be traceable at least to a material of guaranteed purity or other well characterised material. However, the two paths of traceability must not become coincident at too late a stage in the analytical process. For instance, if control materials and calibration standards were prepared from a single stock solution of analyte, IQC would not detect any inaccuracy stemming from the incorrect preparation of the stock solution.

COMPENDIUM OF INTERNATIONAL METHODS OF ANALYSIS –OIV
Harmonized guidelines for internal quality control in analytical
chemistry laboratories

In a typical analytical situation several, or perhaps many, similar test materials will be analysed together, and control materials will be included in the group. Often determinations will be duplicated by the analysis of separate test portions of the same material. Such a group of materials is referred to in this document as an analytical "run". (The words "set", "series" and "batch" have also been used as synonyms for "run".) Runs are regarded as being analysed under effectively constant conditions. The batches of reagents, the instrument settings, the analyst, and the laboratory environment will, under ideal conditions, remain unchanged during analysis of a run. Systematic errors should therefore remain constant during a run, as should the values of the parameters that describe random errors. As the monitoring of these errors is of concern, the run is the basic operational unit of IQC.

A run is therefore regarded as being carried out under repeatability conditions, *i.e.*, the random measurement errors are of a magnitude that would be encountered in a "short" period of time. In practice the analysis of a run may occupy sufficient time for small systematic changes to occur. For example, reagents may degrade, instruments may drift, minor adjustments to instrumental settings may be called for, or the laboratory temperature may rise. However, these systematic effects are, for the purposes of IQC, subsumed into the repeatability variations. Sorting the materials making up a run into a randomised order converts the effects of drift into random errors.

1.2 Scope of this document

This document is a harmonisation of IQC procedures that have evolved in various fields of analysis, notably clinical biochemistry, geochemistry and environmental studies, occupational hygiene and food analysis⁽³⁻⁹⁾. There is much common ground in the procedures from these various fields. Analytical chemistry comprises an even wider range of activities and the basic principles of IQC should be able to encompass all of these. The present document provides guidelines that will be applicable in most instances. This policy necessarily excludes a number of IQC practices that are restricted to individual sectors of the analytical community. In addition in some sectors it is common to combine IQC as defined here with other aspects of quality assurance practice. There is no harm in such combination, but it must remain clear what are the essential aspects of IQC.

**COMPENDIUM OF INTERNATIONAL METHODS OF ANALYSIS –OIV
Harmonized guidelines for internal quality control in analytical
chemistry laboratories**

In order to achieve a harmonisation and provide basic guidance on IQC, some types of analytical activity have been excluded from this document. Issues specifically excluded are as follows.

(i) *Quality control of sampling.* While it is recognised that the quality of the analytical result can be no better than that of the sample, quality control of sampling is a separate subject and in many areas is not fully developed. Moreover, in many instances analytical laboratories have no control over sampling practice and quality.

(ii) *In-line analysis and continuous monitoring.* In this style of analysis there is no possibility of repeating the measurement, so the concept of IQC as used in this document is inapplicable.

(iii) *Multivariate IQC.* Multivariate methods in IQC are still the subject of research and cannot be regarded as sufficiently established for inclusion here. The current document regards multianalyte data as requiring a series of univariate IQC tests. Caution is necessary in the interpretation of this type of data to avoid inappropriately frequent rejection of data.

(iv) *Statutory and contractual requirements.*

(v) *Quality assurance measures* such as checks on instrumental stability before and during analysis, wavelength calibration, balance calibration, tests on resolution of chromatography columns, and problem diagnostics are not included. For present purposes they are regarded as part of the analytical protocol, and IQC tests their effectiveness together with the other aspects of the methodology.

1.3 Internal quality control and uncertainty

A prerequisite of analytical chemistry is the recognition of "fitness for purpose", the standard of accuracy that is required for an effective use of the analytical data. This standard is arrived at by consideration of the intended uses of the data although it is seldom possible to foresee all of the potential future applications of analytical results. For this reason in order to prevent inappropriate interpretation, it is important that a statement of the uncertainty should accompany analytical results, or be readily available to those who wish to use the data.

**COMPENDIUM OF INTERNATIONAL METHODS OF ANALYSIS –OIV
Harmonized guidelines for internal quality control in analytical
chemistry laboratories**

Strictly speaking, an analytical result cannot be interpreted unless it is accompanied by knowledge of its associated uncertainty at a stated level of confidence. A simple example demonstrates this principle. Suppose that there is a statutory requirement that a foodstuff must not contain more than $10 \mu\text{g g}^{-1}$ of a particular constituent. A manufacturer analyses a batch and obtains a result of $9 \mu\text{g g}^{-1}$ for that constituent. If the uncertainty of the result expressed as a half range (assuming no sampling error) is

$0.1 \mu\text{g g}^{-1}$ (i.e. the true result falls, with a high probability, within the range 8.9-9.1) then it may be assumed that the legal limit is not exceeded.

If, in contrast, the uncertainty is $2 \mu\text{g g}^{-1}$ then there is no such assurance. The interpretation and use that may be made of the measurement thus depends on the uncertainty associated with it.

Analytical results should therefore have an associated uncertainty if any definite meaning is to be attached to them or an informed interpretation made. If this requirement cannot be fulfilled, the use to which the data can be put is limited. Moreover, the achievement of the required measurement uncertainty must be tested as a routine procedure, because the quality of data can vary, both in time within a single laboratory and between different laboratories. IQC comprises the process of checking that the required uncertainty is achieved in a run.

2. DEFINITIONS

2.1 International definitions

Quality assurance. All those planned and systematic actions necessary to provide adequate confidence that a product or service will satisfy given requirements for quality⁽¹⁰⁾.

Trueness: closeness of the agreement between the average value obtained from a large series of test results and an accepted reference value⁽¹¹⁾.

Precision: closeness of agreement between independent test results obtained under prescribed conditions⁽¹²⁾.

Bias: difference between the expectation of the test results and an accepted reference value⁽¹¹⁾.

**COMPENDIUM OF INTERNATIONAL METHODS OF ANALYSIS –OIV
Harmonized guidelines for internal quality control in analytical
chemistry laboratories**

Accuracy: closeness of the agreement between the result of a measurement and a true value of the measurand⁽¹³⁾.

Note 1. Accuracy is a qualitative concept.

Note 2. The term *precision* should not be used for *accuracy*.

Error: result of a measurement minus a true value of the measurand⁽¹³⁾.

Repeatability conditions. conditions where independent test results are obtained with the same method on identical test items in the same laboratory by the same operator using the same equipment within short intervals of time⁽¹¹⁾.

Uncertainty of measurement: parameter, associated with the result of a measurement, that characterises the dispersion of the values that could reasonably be attributed to the measurand⁽¹⁴⁾.

Note 1. The parameter may be, for example, a standard deviation (or a given multiple of it), or the half-width of an interval having a stated level of confidence.

Note 2. Uncertainty of measurement comprises, in general, many components. Some of these components may be evaluated from the statistical distribution of results of a series of measurements and can be characterised by experimental standard deviations. The other components, which can also be characterised by standard deviations, are evaluated from assumed probability distributions based on experience or other information.

Note 3. It is understood that the result of a measurement is the best estimate of the value of a measurand, and that all components of uncertainty, including those arising from systematic effects, such as components associated with corrections and reference standards, contribute to the dispersion.

Traceability: property of the result of a measurement or the value of a standard whereby it can be related to stated references, usually national or international standards, through an unbroken chain of comparisons all having stated uncertainties⁽¹³⁾.

Reference material: material or substance one of whose property values are sufficiently homogeneous and well established to be used for the

COMPENDIUM OF INTERNATIONAL METHODS OF ANALYSIS –OIV

Harmonized guidelines for internal quality control in analytical chemistry laboratories

calibration of an apparatus, the assessment of a measurement method, or for assigning values to materials⁽¹³⁾.

Certified reference material: reference material, accompanied by a certificate, one or more of whose property values are certified by a procedure which establishes its traceability to an accurate realisation of the unit in which the property values are expressed, and for which each certified value is accompanied by an uncertainty at a stated level of confidence⁽¹³⁾.

2.2 Definitions of terms specific to this document

Internal quality control: set of procedures undertaken by laboratory staff for the continuous monitoring of operation and the results of measurements in order to decide whether results are reliable enough to be released.

Control material: material used for the purposes of internal quality control and subjected to the same or part of the same measurement procedure as that used for test materials.

Run (analytical run): set of measurements performed under repeatability conditions.

Fitness for purpose: degree to which data produced by a measurement process enables a user to make technically and administratively correct decisions for a stated purpose

Analytical system: range of circumstances that contribute to the quality of analytical data, including equipment, reagents, procedures, test materials, personnel, environment and quality assurance measures.

3. QUALITY ASSURANCE PRACTICES AND INTERNAL QUALITY CONTROL

3.1 Quality assurance

Quality assurance is the essential organisational infrastructure that underlies all reliable analytical measurements. It is concerned with achieving appropriate levels in matters such as staff training and management, adequacy of the laboratory environment, safety, the storage, integrity and identity of samples, record keeping, the maintenance and

calibration of instruments, and the use of technically validated and properly documented methods . Failure in any of these areas might undermine vigorous efforts elsewhere to achieve the desired quality of data. In recent years these practices have been codified and formally recognised as essential. However, the prevalence of these favourable circumstances by no means ensures the attainment of appropriate data quality unless IQC is conducted.

3.2 Choice of analytical method

It is important that laboratories restrict their choice of methods to those that have been characterised as suitable for the matrix and analyte of interest. The laboratory must possess documentation describing the performance characteristics of the method, estimated under appropriate conditions.

The use of a method does not in itself guarantee the achievement of its established performance characteristics. There is, for a given method, only the potential to achieve a certain standard of reliability when the method is applied under a particular set of circumstances. It is this collection of circumstances, known as the "analytical system", that is therefore responsible for the accuracy of analytical data. Hence it is important to monitor the analytical system in order to achieve fitness for purpose. This is the aim of the IQC measures undertaken in a laboratory.

3.3 Internal quality control and proficiency tests

Proficiency testing is a periodic assessment of the performance of individual laboratories and groups of laboratories that is achieved by the distribution by an independent testing body of typical materials for unsupervised analysis by the participants⁽²⁾. Although important, participation in proficiency testing schemes is not a substitute for IQC measures, or *vice versa*.

Proficiency testing schemes can be regarded as a routine, but relatively infrequent, check on analytical errors. Without the support of a well-developed IQC system, the value of participation in a proficiency test is negligible. Probably the main beneficial effect of proficiency tests is that of encouraging participants to install effective quality control systems. It has been shown that laboratories with effective IQC systems performed better in a proficiency testing scheme⁽¹⁵⁾.

4. INTERNAL QUALITY CONTROL PROCEDURES

4.1 Introduction

Internal quality control involves the practical steps undertaken to ensure that errors in analytical data are of a magnitude appropriate for the use to which the data will be put. The practice of IQC depends on the use of two strategies, the analysis of reference materials to monitor trueness and statistical control, and duplication to monitor precision.

The basic approach to IQC involves the analysis of control materials alongside the test materials under examination. The outcome of the control analyses forms the basis of a decision regarding the acceptability of the test data. Two key points are worth noting in this context.

(i) The interpretation of control data must be based on documented, objective criteria, and on statistical principles wherever possible.

(ii) The results of control analyses should be viewed primarily as indicators of the performance of the analytical system, and only secondarily as a guide to the errors associated with individual test results. Substantial changes in the apparent accuracy of control determinations can sometimes be taken to imply similar changes to data for contemporary test materials, but correction of analytical data on the basis of this premise is unacceptable.

4.2 General Approach - Statistical Control

The interpretation of the results of IQC analyses depends largely on the concept of statistical control, which corresponds with stability of operation. Statistical control implies that an IQC result x can be interpreted as arising independently and at random from a normal population with mean μ and variance σ^2 .

Under these constraints only about 0.27% of results (x) would fall outside the bounds of $\mu \pm 3\sigma$. When such extreme results are encountered they are regarded as being "out-of-control" and interpreted to mean that the analytical system has started to behave differently. Loss of control therefore implies that the data produced by the system are of unknown accuracy and hence cannot be relied upon. The analytical system therefore requires investigation and remedial action before further analysis is undertaken. Compliance with statistical control can be monitored graphically with Shewhart control charts (see Appendix 1). An equivalent

numerical approach, comparing values of $z = (x-\mu)/\sigma$ against appropriate values of the standard normal deviate, is also possible.

4.3 Internal quality control and fitness for purpose.

For the most part, the process of IQC is based on a description in terms of the statistical parameters of an ongoing analytical system in normal operation. Control limits are therefore based on the estimated values of these parameters rather than measures derived from considerations of fitness for purpose. Control limits must be narrower than the requirements of fitness for purpose or the analysis would be futile.

The concept of statistical control is inappropriate, however, when the so-called *ad hoc* analysis is being undertaken. In *ad hoc* analysis the test materials may be unfamiliar or rarely encountered, and runs are often made up of only a few such test materials. Under these circumstances there is no statistical basis for the construction of control charts. In such an instance the analytical chemist has to use fitness for purpose criteria, historical data or consistency with the visual properties of the test material for judging the acceptability of the results obtained.

Either way, agreed methods of establishing quantitative criteria to characterise fitness for purpose would be desirable. Unfortunately, this is one of the less-developed aspects of IQC. In specific application areas guidelines may emerge by consensus. For example, in environmental studies it is usually recognised that relative uncertainties of less than ten percent in the concentration of a trace analyte are rarely of consequence. In food analysis the Horwitz curve⁽¹⁶⁾ is sometimes used as a fitness for purpose criterion. Such criteria have been defined for clinical analysis^(17,18). In some areas of applied geochemistry a systematic approach has given rise to fitness for purpose criteria for sampling and analytical precisions. However, it is not practicable here to give guidelines in these areas, and at present no general principles can be advanced that would allow specific applications to be addressed.

4.4 The nature of errors

Two main categories of analytical error are recognised, namely random errors and systematic errors, which give rise to imprecision and bias respectively. The importance of categorising errors in this way lies in the fact that they have different sources, remedies and consequences for the interpretation of data.

COMPENDIUM OF INTERNATIONAL METHODS OF ANALYSIS –OIV
Harmonized guidelines for internal quality control in analytical
chemistry laboratories

Random errors determine the precision of measurement. They cause random positive and negative deviations of results about the underlying mean value. *Systematic errors* comprise displacement of the mean of many determinations from the true value. For the purposes of IQC two levels of systematic error are worth consideration.

(i) *Persistent bias* affects the analytical system (for a given type of test material) over a long period and affects all data. Such bias, if small in relation to random error, may be identifiable only after the analytical system has been in operation for a long time. It might be regarded as tolerable, provided it is kept within prescribed bounds.

(ii) *The run effect* is exemplified by a deviation of the analytical system during a particular run. This effect, where it is sufficiently large, will be identified by IQC at the time of occurrence as an out-of-control condition.

The conventional division of errors between the random and the systematic depends on the timescale over which the system is viewed. Run effects of unknown source can be regarded in the long-term as the manifestation of a random process. Alternatively, if a shorter-term view is taken, the same variation could be seen as a bias-like change affecting a particular run.

The statistical model used for IQC in this document is as follows¹. The value of a measurement (x) in a particular run is given by:

$x = \text{true value} + \text{persistent bias} + \text{run effect} + \text{random error} (+ \text{gross error}).$

The variance of x (σ_x^2) in the absence of gross errors is given by:

$$\sigma_x^2 = \sigma_0^2 + \sigma_1^2$$

where

$\sigma_0^2 =$ variance of the random error (within run) and

$\sigma_1^2 =$ variance of the run effect.

The variances of the true value and the persistent bias are both zero. An analytical system in control is fully described by σ_0^2 , σ_1^2 and the value of

¹ ? The model could be extended if necessary to include other features of the analytical system

the persistent bias. Gross errors are implied when the analytical system does not comply with such a description.

5 IQC AND WITHIN-RUN PRECISION

5.1 Precision and duplication

A limited control of within-run precision is achieved by the duplication within a run of measurements made on test materials. The objective is to ensure that the differences between paired results are consistent with or better than the level implied by the value of σ_0 used by a laboratory for IQC purposes². Such a test alerts the user to the possibility of poor within-run precision and provides additional information to help in interpreting control charts. The method is especially useful in *ad hoc* analysis, where attention is centred on a single run and information obtained from control materials is unlikely to be completely satisfactory.

As a general approach all of the test materials, or a random selection from them, are analysed in duplicate. The absolute differences $|d| = |x_1 - x_2|$ between duplicated analytical results x_1 and x_2 are tested against an upper control limit based on an appropriate value of σ_0 . However, if the test materials in the run have a wide range of concentration of analyte, no single value of σ_0 can be assumed⁽¹⁹⁾.

Duplicates for IQC must reflect as far as possible the full range of variation present in the run. They must not be analysed as adjacent members of the run, otherwise they will reveal only the smallest possible measure of analytical variability. The best placing of duplicates is at random within each run. Moreover the duplication required for IQC requires the complete and independent analysis (preferably blind) of separate test portions of the test material. A duplication of the instrumental measurement of a single test solution would be ineffective because the variations introduced by the preliminary chemical treatment of the test material would be absent.

5.2 Interpretation of duplicate data

² ? There is no intention here of estimating the standard deviation of repeatability σ_r from the IQC data or of comparing estimates: there would usually be too few results for a satisfactory outcome. Where such an estimate is needed the formula $s_r = \sqrt{\sum d^2 / 2n}$ can be used.

**COMPENDIUM OF INTERNATIONAL METHODS OF ANALYSIS –OIV
Harmonized guidelines for internal quality control in analytical
chemistry laboratories**

5.2.1 Narrow concentration range. In the simplest situation the test materials comprising the run have a small range of analyte concentrations so that a common within-run standard deviation σ_0 can be applied.

A value of this parameter must be estimated to provide a control limit. The upper 95% bound of $|d|$ is $2\sqrt{2}\sigma_0$ and on average only about three in a thousand results should exceed $3\sqrt{2}\sigma_0$. A group of n duplicated results can be interpreted in several ways.

For example, the standardised difference

$$z_d = d / \sqrt{2} \sigma_0$$

should have a normal distribution with zero mean and unit standard deviation. The sum of a group of n such results would have a standard deviation of \sqrt{n} so only about three runs in a thousand would produce a value of $|\sum z_d| > 3\sqrt{n}$. Alternatively a group of n values of z_d from a run can be combined to form $\sum z_d^2$ and the result interpreted as a sample from a chi-squared distribution with n degrees of freedom, (χ_n^2) . Some caution is needed in the use of this statistic, however, as it is sensitive to outlying results.

5.2.2 Wide concentration range. If the test materials comprising a run have a wide range of analyte concentrations, no common standard of precision (σ_0) can be assumed. In such an instance σ_0 must be expressed as a functional relationship with concentration. The value of concentration for a particular material is taken to be $(x_1 + x_2)/2$, and an appropriate value of σ_0 obtained from the functional relationship, the parameters of which have to be estimated in advance.

6. CONTROL MATERIALS IN IQC

6.1 Introduction

Control materials are characterised substances that are inserted into the run alongside the test materials and subjected to exactly the same treatment. A control material must contain an appropriate concentration of the analyte, and a value of that concentration must be assigned to the material. Control

materials act as surrogates for the test materials and must therefore be representative, *i.e.*, they should be subject to the same potential sources of error. To be fully representative, a control material must have the same matrix in terms of bulk composition, including minor constituents that may have a bearing on accuracy. It should also be in a similar physical form, *i.e.*, state of comminution, as the test materials. There are other essential characteristics of a control material. It must be adequately stable over the period of interest. It must be possible to divide the control material into effectively identical portions for analysis. It is often required in large amounts to allow its use over an extended period.

Reference materials in IQC are used in combination with control charts that allow both persistent bias and run effects to be addressed (Appendix 1). Persistent bias is evident as a significant deviation of the centre line from the assigned value. The variation in the run effect is predictable in terms of a standard deviation when the system is under statistical control, and that standard deviation is used to define action limits and warning limits at appropriate distances from the true value.

6.2 The role of certified reference materials

Certified reference materials (CRM) as defined in Section 2 (*i.e.*, with a statement of uncertainty and traceability), when available and of suitable composition, are ideal control materials in that they can be regarded for traceability purposes as ultimate standards of trueness⁽²⁰⁾. In the past CRMs were regarded as being for reference purposes only and not for routine use. A more modern approach is to treat CRMs as consumable and therefore suitable for IQC.

The use of CRMs in this way is, however, subject to a number of constraints.

- (i) Despite the constantly increasing range of CRMs available, for the majority of analyses there is no closely matching CRM available.
- (ii) Although the cost of CRMs is not prohibitive in relation to the total costs of analysis, it may not be possible for a laboratory with a wide range of activities to stock every relevant kind of reference material.
- (iii) The concept of the reference material is not applicable to materials where either the matrix or the analyte is unstable.

**COMPENDIUM OF INTERNATIONAL METHODS OF ANALYSIS –OIV
Harmonized guidelines for internal quality control in analytical
chemistry laboratories**

(iv) CRMs are not necessarily available in sufficient amounts to provide for IQC use over extended periods.

(v) It must be remembered that not all apparently certified reference materials are of equal quality. Caution is suggested when the information on the certificate is inadequate.

If for any of the above reasons the use of a CRM is not appropriate it falls on individual laboratories or groups of laboratories to prepare their own control materials and assign traceable³ values of analyte concentration to them. Such a material is sometimes referred to as a "house reference material" (HRM). Suggestions for preparing HRMs are listed in Section 6.3. Not all of the methods described there are applicable to all analytical situations.

6.3 Preparation of control materials

6.3.1 Assigning a true value by analysis. In principle a working value can be assigned to a stable reference material simply by careful analysis. However, precautions are necessary to avoid biases in the assigned value. This requires some form of independent check such as may be provided by analysis of the materials in a number of laboratories and where possible, the use of methods based on different physico-chemical principles. Lack of attention to independent validation of control materials has been shown to be a weakness in IQC systems⁽¹⁵⁾.

One way of establishing a traceable assigned value in a control material is to analyse a run comprising the candidate material and a selection of matching CRMs, with replication and randomisation. This course of action would be appropriate if only limited amounts of CRMs were available. The CRMs must be appropriate in both matrix composition and analyte concentration. The CRMs are used directly to calibrate the analytical procedure for the analysis of the control material. An appropriate analytical method is a prerequisite for this approach. It would be a dangerous approach if, say, a minor and variable fraction of the analyte were extracted for measurement. The uncertainty introduced into the assigned value must also be considered.

³ ?Where a CRM is not available traceability only to a reference method or to a batch of a reagent supplied by a manufacturer may be necessary.

**COMPENDIUM OF INTERNATIONAL METHODS OF ANALYSIS –OIV
Harmonized guidelines for internal quality control in analytical
chemistry laboratories**

6.3.2 Materials validated in proficiency testing comprise a valuable source of control materials. Such materials would have been analysed by many laboratories using a variety of methods. In the absence of counter-indications, such as an obvious bias or unusual frequency distribution of results, the consensus of the laboratories could be regarded as a validated assigned value to which a meaningful uncertainty could be attached. (There is a possibility that the consensus could suffer from a bias of consequence, but this potential is always present in reference values.) There would be a theoretical problem of establishing the traceability of such a value, but that does not detract from the validity of the proposed procedure. The range of such materials available would be limited, but organisers of proficiency tests could ensure a copious supply by preparing batches of material in excess of the immediate requirements of the round. The normal requirements of stability would have to be demonstrable.

6.3.3 Assigning a true value by formulation. In favourable instances a control material can be prepared simply by mixing constituents of known purity in predetermined amounts. For example, this approach would often be satisfactory in instances where the control material is a solution. Problems are often encountered in formulation in producing solid control materials in a satisfactory physical state or in ensuring that the speciation and physical distribution of the analyte in the matrix is realistic. Moreover an adequate mixing of the constituents must be demonstrable.

6.3.4 Spiked control materials. "Spiking" is a way of creating a control material in which a value is assigned by a combination of formulation and analysis. This method is feasible when a test material essentially free of the analyte is available. After exhaustive analytical checks to ensure the background level is adequately low, the material is spiked with a known amount of analyte. The reference sample prepared in this way is thus of the same matrix as the test materials to be analysed and of known analyte level - the uncertainty in the assigned concentration is limited only by the possible error in the unspiked determination. However, it may be difficult to ensure that the speciation, binding and physical form of the added analyte is the same as that of the native analyte and that the mixing is adequate.

6.3.5 Recovery Checks. If the use of a reference material is not practicable then a limited check on bias is possible by a test of recovery. This is especially useful when analytes or matrices cannot be stabilised or when *ad hoc* analysis is executed. A test portion of the test material spiked with a known amount of the analyte and analysed alongside the original test material. The recovery of the added analyte (known as the "marginal

recovery") is the difference between the two measurements divided by the amount that is added. The obvious advantages of recovery checks are that the matrix is representative and the approach is widely applicable - most test materials can be spiked by some means. However, the recovery check suffers from the disadvantage previously noted regarding the speciation, binding and physical distribution of the analyte. Furthermore, the assumption of an equivalent recovery of the analyte added as a spike and of the native analyte may not be valid. However, it can normally be assumed that a poor performance in a recovery check is strongly indicative of a similar or worse performance for the native analyte in the test materials.

Spiking and recovery testing as an IQC method must be distinguished from the method of standard additions, which is a measurement procedure: a single spiking addition cannot be used to fulfil the roles of both measurement and IQC.

6.4 Blank determinations

Blank determinations are nearly always an essential part of the analytical process and can conveniently be effected alongside the IQC protocol. The simplest form of blank is the "reagent blank", where the analytical procedure is executed in all respects apart from the addition of the test portion. This kind of blank, in fact, tests more than the purity of the reagents. For example it is capable of detecting contamination of the analytical system originating from any source, *e.g.*, glassware and the atmosphere, and is therefore better described as a "procedural blank". In some instances, better execution of blank determinations is achieved if a simulated test material is employed. The simulant could be an actual test material known to be virtually analyte-free or a surrogate (*e.g.*, ashless filter paper used instead of plant material). Where it can be contrived, the best type of blank is the "field blank", which is a typical matrix with zero concentration of analyte.

An inconsistent set of blanks in a run suggests sporadic contamination and may add weight to IQC evidence suggesting the rejection of the results. When an analytical protocol prescribes the subtraction of a blank value, the blank value must be subtracted also from the results of the control materials before they are used in IQC.

6.5 Traceability in spiking and recovery checks

Potential problems of the traceability of reagents used for spikes and recovery checks must be guarded against. Under conditions where CRMs

**COMPENDIUM OF INTERNATIONAL METHODS OF ANALYSIS –OIV
Harmonized guidelines for internal quality control in analytical
chemistry laboratories**

are not available, traceability can often be established only to the batch of analyte provided by a manufacturer. In such cases, confirmation of identity and a check on purity must be made before use. A further precaution is that the calibration standards and spike should not be traceable to the same stock solution of analyte or the same analyst. If such a common traceability existed, then the corresponding sources of error would not be detected by the IQC.

7. RECOMMENDATIONS

The following recommendations represent integrated approaches to IQC that are suitable for many types of analysis and applications areas. Managers of laboratory quality systems will have to adapt the recommendations to the demands of their own particular requirements. Such adaptation could be implemented, for example, by adjusting the number of duplicates and control material inserted into a run, or by the inclusion of any additional measures favoured in the particular application area. The procedure finally chosen and its accompanying decision rules must be codified in an IQC protocol that is separate from the analytical system protocol.

The practical approach to quality control is determined by the frequency with which the measurement is carried out and the size and nature of each run. The following recommendations are therefore made. The use of control charts and decision rules are covered in Appendix 1.

In each of the following the order in the run in which the various materials are analysed should be randomised if possible. A failure to randomise may result in an underestimation of various components of error.

(i) *Short (e.g., $n < 20$) frequent runs of similar materials.* Here the concentration range of the analyte in the run is relatively small, so a common value of standard deviation can be assumed.

Insert a control material at least once per run. Plot either the individual values obtained, or
The mean value, on an appropriate control chart. Analyse in duplicate at least half of the
Test materials, selected at random. Insert at least one blank determination.

(ii) *Longer (e.g., $n > 20$) frequent runs of similar materials.* Again a common level of standard deviation is assumed.

COMPENDIUM OF INTERNATIONAL METHODS OF ANALYSIS –OIV
Harmonized guidelines for internal quality control in analytical
chemistry laboratories

Insert the control material at an approximate frequency of one per ten test materials. If the run size is likely to vary from run to run it is easier to standardise on a fixed number of insertions per run and plot the mean value on a control chart of means. Otherwise plot individual values.

Analyse in duplicate a minimum of five test materials selected at random. Insert one blank determination per ten test materials.

(iii) *Frequent runs containing similar materials but with a wide range of analyte concentration.*

Here we cannot assume that a single value of standard deviation is applicable.

Insert control materials in total numbers approximately as recommended above. However, there should be at least two levels of analyte represented, one close to the median level of typical test materials, and the other approximately at the upper or lower decile as appropriate. Enter values for the two control materials on separate control charts. Duplicate a minimum of five test materials, and insert one procedural blank per ten test materials.

(iv) *Ad hoc analysis.* Here the concept of statistical control is not applicable. It is assumed, however, that the materials in the run are of a single type, *i.e.*, sufficiently similar for general conclusions on errors to be made.

Carry out duplicate analysis on all of the test materials. Carry out spiking or recovery tests or use a formulated control material, with an appropriate number of insertions (see above), and with different concentrations of analyte if appropriate. Carry out blank determinations. As no control limits are available, compare the bias and precision with fitness for purpose limits or other established criteria..

8. CONCLUSIONS

Internal quality control is an essential aspect of ensuring that data released from a laboratory are fit for purpose. If properly executed, quality control methods can monitor the various aspects of data quality on a run-by-run basis. In runs where performance falls outside acceptable limits, the data produced can be rejected and, after remedial action on the analytical system, the analysis can be repeated.

It must be stressed, however, that internal quality control is not foolproof even when properly executed. Obviously it is subject to "errors of both kinds", *i.e.*, runs that are in control will occasionally be rejected and runs that are out of control occasionally accepted. Of more importance, IQC cannot usually identify sporadic

COMPENDIUM OF INTERNATIONAL METHODS OF ANALYSIS –OIV
Harmonized guidelines for internal quality control in analytical
chemistry laboratories

gross errors or short-term disturbances in the analytical system that affect the results for individual test materials. Moreover, inferences based on IQC results are applicable only to test materials that fall within the scope of the analytical method validation. Despite these limitations, which professional experience and diligence can alleviate to a degree, internal quality control is the principal recourse available for ensuring that only data of appropriate quality are released from a laboratory. When properly executed it is very successful.

Finally, it must be appreciated that a perfunctory execution of any quality system will not guarantee the production of data of adequate quality. The correct procedures for feedback, remedial action and staff motivation must also be documented and acted upon. In other words, there must be a genuine commitment to quality within a laboratory for an internal quality control programme to succeed, *i.e.*, the IQC must be part of a total quality management system.

9. REFERENCES

- 1 *"Protocol for the Design, Conduct and Interpretation of Method Performance Studies"*, Edited W Horwitz, *Pure Appl. Chem.*, 1988, **60**, 855- 864. (*Revision in press*)
- 2 *"The International Harmonised Protocol for the Proficiency Testing of (Chemical) Analytical Laboratories"*, Edited M Thompson and R Wood, *Pure Appl. Chem.*, 1993, **65**, 2123-2144. (Also published in *J. AOAC International*, 1993, **76**, 926-940.
- 3 *"IFCC approved recommendations on quality control in clinical chemistry. Part 4: internal quality control"*, *J. Clin. Chem. Clin. Biochem.*, 1980, **18**, 534-541.
- 4 S Z Cekan, S B Sufi and E W Wilson, *"Internal quality control for assays of reproductive hormones: Guidelines for laboratories"*. WHO, Geneva, 1993.
- 5 M Thompson, *"Control procedures in geochemical analysis"*, in R J Howarth (Ed), *"Statistics and data analysis in geochemical prospecting"*, Elsevier, Amsterdam, 1983.
- 6 M Thompson, *"Data quality in applied geochemistry: the requirements and how to achieve them"*, *J. Geochem. Explor.*, 1992, **44**, 3-22.
- 7 Health and Safety Executive, *"Analytical quality in workplace air monitoring"*, London, 1991.
- 8 *"A protocol for analytical quality assurance in public analysts' laboratories"*, Association of Public Analysts, 342 Coleford Road, Sheffield S9 5PH, UK, 1986.
- 9 *"Method evaluation, quality control, proficiency testing" (AMIQAS PC Program)*, National Institute of Occupational Health, Denmark, 1993.

**COMPENDIUM OF INTERNATIONAL METHODS OF ANALYSIS –OIV
Harmonized guidelines for internal quality control in analytical
chemistry laboratories**

- 10 ISO 8402:1994. *"Quality assurance and quality management - vocabulary"*.
- 11 ISO 3534 -1: 1993 (E/F). *"Statistics, vocabulary and symbols - Part 1: Probability and general statistical terms"*.
- 12 ISO Guide 30:1992. *"Terms and definitions used in connections with reference materials"*
- 13 *"International vocabulary for basic and general terms in metrology"* , 2nd Edition, 1993, ISO, Geneva.
- 14 *"Guide to the expression of uncertainty in measurement"*, ISO, Geneva, 1993.
- 15 M Thompson and P J Lowthian, *Analyst*, 1993, **118**, 1495-1500.
- 16 W Horwitz, L R Kamps and K W Boyer, *J. Assoc. Off. Anal. Chem.*, 1980, **63**, 1344.
- 17 D Tonks, *Clin. Chem.*, 1963, **9**, 217-223.
- 18 G C Fraser, P H Petersen, C Ricos and R Haeckel, *"Proposed quality specifications for the imprecision and inaccuracy of analytical systems for clinical chemistry"*, *Eur. J. Clin. Chem. Clin. Biochem.*, 1992, **30**, 311-317.
- 19 M Thompson, *Analyst*, 1988, **113**, 1579-1587.
- 20 ISO Guide 33: 1989, *"Uses of Certified Reference Materials"*, Geneva.

APPENDIX 1. SHEWHART CONTROL CHARTS

1. INTRODUCTION

The theory, construction and interpretation of the Shewhart chart⁽¹⁾ are detailed in numerous texts on process quality control and applied statistics, and in several ISO standards⁽²⁻⁵⁾. There is a considerable literature on the use of the control chart in clinical chemistry^(6,7). Westgard and co-workers have formulated multiple rules for the interpretation of such control charts⁽⁸⁾, and the power of these results has been studied in detail⁽⁹⁻¹⁰⁾. In this appendix only simple Shewhart charts are considered.

In IQC a Shewhart control chart is obtained when values of concentration measured on a control material in successive runs are plotted on a vertical axis against the run number on the horizontal axis. If more than one analysis of a particular control material is made in a run, either the individual results x or the mean value \bar{x} can be used to form a control chart. The chart is completed by horizontal lines derived from the normal distribution $N(\mu, \sigma^2)$ that is taken to describe the random variations in the plotted values. The selected lines for control purposes are $\mu \pm 2\sigma$ and $\mu \pm 3\sigma$. Different values of σ are required for charts of individual values and of means. For a system in statistical control, on average about one in twenty values fall outside the $\mu \pm 2\sigma$ lines, called the "warning limits", and only about three in one thousand fall outside the $\mu \pm 3\sigma$ lines, the "action limits". In practice the estimates \bar{x} and s of the parameters μ and σ are used to construct the chart. A persistent bias is indicated by a significant difference between \bar{x} and the assigned value

2. ESTIMATES OF THE PARAMETERS μ and σ

An analytical system under control exhibits two sources of random variation, the within-run, characterised by variance σ_0^2 and the between-run with variance σ_1^2 . The two variances are typically comparable in magnitude. The standard deviation σ_x used in a chart of individual values is given by

$$\sigma_x = (\sigma_0^2 + \sigma_1^2)^{1/2}$$

whereas for a control chart of mean values the standard deviation is given by

$$\sigma_{\bar{x}} = (\sigma_0^2/n + \sigma_1^2)^{1/2}$$

COMPENDIUM OF INTERNATIONAL METHODS OF ANALYSIS –OIV
Harmonized guidelines for internal quality control in analytical
chemistry laboratories

where n is the number of control measurements in a run from which the mean is calculated. The value of n therefore must be constant from run to run, otherwise control limits would be impossible to define. If a fixed number of repeats of a control material per run cannot be guaranteed (e.g., if the run length were variable) then charts of individual values must be used. Furthermore the equation indicates that σ_x or $\sigma_{\bar{x}}$ must be estimated with care. An attempt to base an estimate on repeat values from a single run would result in unduly narrow control limits.

Estimates must therefore include the between-run component of variance. If the use of a particular value of n can be assumed at the outset, then $\sigma_{\bar{x}}$ can be

estimated directly from the m means $\bar{x}_i = \sum_{j=1}^n x_{ij} / n$

($i = 1, \dots, m$) of the n repeats in each of m successive runs.

Thus the estimate of μ is

$$\bar{x} = \sum_i \bar{x}_i / m$$

and the estimate of $\sigma_{\bar{x}}$ is

$$s_{\bar{x}} = \sqrt{\frac{\sum_i (\bar{x}_i - \bar{x})^2}{m - 1}}$$

If the value of n is not predetermined, then separate estimates of σ_0 and σ_1 could be obtained by one-way analysis of variance. If the mean squares within- and between- groups are MS_w and MS_b respectively, then

σ_0^2 is estimated by MS_w and

σ_1^2 is estimated by $(MS_b - MS_w)/n$

Often in practice it is necessary to initiate a control chart with data collected from a small number of runs, which may be to a degree unrepresentative, as estimates of standard deviation are very variable unless large numbers of observations are used. Moreover, during the initial period, the occurrence of out-of-control conditions are

COMPENDIUM OF INTERNATIONAL METHODS OF ANALYSIS –OIV
Harmonized guidelines for internal quality control in analytical
chemistry laboratories

more than normally likely and will produce outlying values. Such values would bias \bar{x} and inflate s beyond its proper value. It is therefore advisable to recalculate \bar{x} and s after a further "settling down" period. One method of obviating the effects of outliers in the calculation is to reject them after the application of Dixon's Q or Grubbs⁽¹¹⁾ test, and then use the classical statistics given above. Alternatively, the methods of robust statistics could be applied to the data^(12, 13).

3. THE INTERPRETATION OF CONTROL CHARTS

The following simple rules can be applied to control charts of individual results or of means.

Single control chart. An out-of-control condition in the analytical system is signalled if any of the following occur.

- (i) The current plotting value falls outside the action limits.
- (ii) The current value and the previous plotting value fall outside the warning limits but within the actions limits.
- (iii) Nine successive plotting values fall on the same side of the mean line.

Two control charts. When two different control materials are used in each run, the respective control charts are considered simultaneously. This increases the chance of a type 1 error (rejection of a sound run) but decreases the chance of a type 2 error (acceptance of a flawed run). An out-of-control condition is indicated if any of the following occur.

- (i) At least one of the plotting values falls outside the action limits.
- (ii) Both of the plotting values are outside the warning limits.
- (iii) The current value and the previous plotting value on the same control chart both fall outside the warning limits.
- (iv) Both control charts simultaneously show that four successive plotting values on the same side of the mean line.

- (v) One of the charts shows nine successive plotting values falling on the same side of the mean line.

A more thorough treatment of the control chart can be obtained by the application of the full Westgard rules, illustrated in Figure 2.

COMPENDIUM OF INTERNATIONAL METHODS OF ANALYSIS –OIV
Harmonized guidelines for internal quality control in analytical
chemistry laboratories

The analytical chemist should respond to an out-of-control condition by cessation of analysis pending diagnostic tests and remedial action followed by rejection of the results of the run and reanalysis of the test materials.

4. REFERENCES

- 1 W A Shewhart, *"Economic control of quality in manufactured product"*, Van Nostrand, New York, 1931.
- 2 ISO 8258:1991. *"Shewhart control charts"*.
- 3 ISO 7873:1993 *"Control charts for arithmetic means with warning limits"*.
- 4 ISO 7870:1993. *"Control charts - general guide and introduction"*.
- 5 ISO 7966:1993. *"Acceptance control charts"*.
- 6 S Levey and E R Jennings, *Am. J. Clin. Pathol.*, 1950, **20**, 1059-1066.
- 7 A B J Nix, R J Rowlands, K W Kemp, D W Wilson and K Griffiths, *Stat. Med.*, 1987,**6**,425-440.
- 8 J O Westgard, P L Barry and M R Hunt, *Clin. Chem.*, 1981, **27**, 493-501.
- 9 C A Parvin, *Clin. Chem.*, 1992, **38**, 358-363.
- 10 J Bishop and A B J Nix, *Clin. Chem.*, 1993, **39**, 1638-1649.
- 11 W Horwitz, *Pure Appl. Chem.*, (in press).
- 12 Analytical Methods Committee, *Analyst*, 1989, **114**, 1693-1697.
- 13 Analytical Methods Committee, *Analyst*, 1989, **114**, 1699-1702.

Technical report from the Symposium on the 'Harmonisation of quality assurance systems for Analysis Laboratories, Washington DC, USA, 22-23 July 1993 sponsored by IUPAC, ISO et AOAC International

Prepared for publication by MICHAEL THOMPSON¹ and ROGER WOOD²

¹*Department of Chemistry, Birkbeck College (University of London), London WC1H 0PP, UK*

²*MAFF Food Science Laboratory, Norwich Research Park, Colney, Norwich NR4 7UQ, UK*

1991-95 work group :

Chairman : M. Parkany (Switzerland) ; Membres : T. Anglov (Denmark) ; K. Bergknut (Norway and Sweden) ; P. De Biève (Belgium) ; K.-G. von Boroviczény (Germany) ; J.M. Christensen (Denmark) ; T.D. Geary (South Australia) ; R. Greenhalgh (Canada) ; A.J. Head (United Kingdom) ; P.T. Holland (New Zealand) ; W. Horwitz (USA) . A. Kallner (Sweden) ; J. Kristiansen (Denmark) ; S.H.H. Orlachs (Netherlands) ; N. Palmer (USA) . M. Thompson (United Kingdom) ; M.J. Vernengo (Argentina) ; R. Wood (United Kingdom).

**COMPENDIUM OF INTERNATIONAL ANALYSIS OF METHODS -
OIV
Guide for the validation – quality control**

**Practical guide for the validation, quality control, and uncertainty assessment of an alternative
oenological analysis method
(Resolution OENO 10/2005)**

Contents

1. PURPOSE.....	5
2. PREAMBLE AND SCOPE.....	5
3. GENERAL VOCABULARY.....	6
4. GENERAL PRINCIPLES.....	12
4.1 METHODOLOGY.....	12
4.2 DEFINITION OF MEASUREMENT ERROR.....	13
5. VALIDATING A METHOD.....	14
5.1 METHODOLOGY.....	14
5.2 SECTION ONE: SCOPE OF METHOD.....	15
5.2.1 <i>Definition of analyzable matrices</i>	15
5.2.2 <i>Detection and quantification limit</i>	15
5.2.2.1 Normative definition.....	16
5.2.2.2 Reference documents.....	16
5.2.2.3 Application.....	16
5.2.2.4 Procedure.....	16
5.2.2.4.1 Determination on blank.....	16
5.2.2.4.1.1 Scope.....	16
5.2.2.4.1.2 Basic protocol and calculations.....	17
5.2.2.4.2 Approach by linearity study.....	18
5.2.2.4.2.1 Scope.....	18
5.2.2.4.2.2 Basic protocol and calculations.....	19
5.2.2.4.3 Graphic approach based on the background noise of the recording.....	21
5.2.2.4.3.1 Scope.....	21
5.2.2.4.3.2 Basic protocol and calculation.....	21
5.2.2.4.4 Checking a predetermined quantification limit.....	21
5.2.2.4.4.1 Scope.....	21
5.2.2.4.4.2 Basic protocol and calculation.....	22
5.2.3 <i>Robustness</i>	24
5.2.3.1 Definition.....	24
5.2.3.2 Determination.....	24
5.3 SECTION TWO: SYSTEMATIC ERROR STUDY.....	24
5.3.1 <i>Linearity study</i>	24
5.3.1.1 Normative definition.....	24
5.3.1.2 Reference documents.....	24
5.3.1.3 Application.....	24

**COMPENDIUM OF INTERNATIONAL ANALYSIS OF METHODS -
OIV
Guide for the validation – quality control**

5.3.1.4	ISO 11095-type approach.....	25
5.3.1.4.1	Basic protocol.....	25
5.3.1.4.2	Calculations and results.....	26
5.3.1.4.2.1	Defining the regression model.....	26
5.3.1.4.2.2	Estimating parameters.....	27
5.3.1.4.2.3	Charts.....	27
5.3.1.4.2.4	Test of the linearity assumption.....	29
5.3.1.4.2.4.1	Definitions of errors linked to calibration.....	29
5.3.1.4.2.4.2	Fischer-Snedecor test.....	31
5.3.1.5	ISO 8466-type approach.....	32
5.3.1.5.1	Basic protocol.....	32
5.3.1.5.2	Calculations and results.....	33
5.3.1.5.2.1	Defining the linear regression model.....	33
5.3.1.5.2.2	Defining the polynomial regression model.....	33
5.3.1.5.2.3	Comparing residual standard deviations.....	34
5.3.2	<i>Specificity</i>	36
5.3.2.1	Normative definition.....	36
5.3.2.2	Application.....	36
5.3.2.3	Procedures.....	36
5.3.2.3.1	Standard addition test.....	36
5.3.2.3.1.1	Scope.....	36
5.3.2.3.1.2	Basic protocol.....	36
5.3.2.3.1.3	Calculations and results.....	37
5.3.2.3.1.3.1	Study of the regression line $r = a + b.v$	37
5.3.2.3.1.3.2	Analysis of the results.....	38
5.3.2.3.1.3.3	Overlap line graphics.....	40
5.3.2.3.2	Study of the influence of other compounds on the measurement result.....	40
5.3.2.3.2.1	Scope.....	40
5.3.2.3.2.2	Basic protocol and calculations.....	40
5.3.2.3.2.3	Interpretation.....	41
5.3.3	<i>Study of method accuracy</i>	43
5.3.3.1	Presentation of the step.....	43
5.3.3.1.1	Definition.....	43
5.3.3.1.2	General principles.....	43
5.3.3.1.3	Reference documents.....	43
5.3.3.2	Comparison of the alternative method with the OIV reference method.....	44
5.3.3.2.1	Scope.....	44
5.3.3.2.2	Accuracy of the alternative method compared with the reference method.....	44
5.3.3.2.2.1	Definition.....	44
5.3.3.2.2.2	Scope.....	44
5.3.3.2.2.3	Basic protocol and calculations.....	44
5.3.3.2.2.4	Interpretation.....	46
5.3.3.3	Comparison by interlaboratory tests.....	47
5.3.3.3.1	Scope.....	47
5.3.3.3.2	Basic protocol and calculations.....	48
5.3.3.3.3	Interpretation.....	49
5.3.3.4	Comparison with reference materials.....	50
5.3.3.4.1	Scope.....	50
5.3.3.4.2	Basic protocol and calculations.....	50
5.3.3.4.3	Interpretation.....	51
5.4	SECTION THREE: RANDOM ERROR STUDY.....	52
5.4.1	<i>General principle</i>	52

**COMPENDIUM OF INTERNATIONAL ANALYSIS OF METHODS -
OIV
Guide for the validation – quality control**

5.4.2	Reference documents.....	53
5.4.3	Precision of the method.....	53
5.4.3.1	Definition.....	53
5.4.3.2	Scope.....	53
5.4.3.3	General theoretical case.....	54
5.4.3.3.1	Basic protocol and calculations.....	54
5.4.3.3.1.1	Calculations with several test materials.....	54
5.4.3.3.1.2	Calculations with 1 test material.....	56
5.4.3.4	Repeatability.....	57
5.4.3.4.1	Definitions.....	57
5.4.3.4.2	Scope.....	58
5.4.3.4.3	Basic protocol and calculations.....	58
5.4.3.4.3.1	General case.....	58
5.4.3.4.3.2	Particular case applicable to only 1 repetition.....	58
5.4.3.4.4	Comparison of repeatability.....	60
5.4.3.4.4.1	Determination of the repeatability of each method.....	60
5.4.3.4.4.2	Fischer-Snedecor test.....	61
5.4.3.5	Intralaboratory reproducibility.....	62
5.4.3.5.1	Definition.....	62
5.4.3.5.2	Scope.....	62
5.4.3.5.3	Basic protocol and calculations.....	62
6.	QUALITY CONTROL OF ANALYSIS METHODS (IQC).....	64
6.1	REFERENCE DOCUMENTS.....	64
6.2	GENERAL PRINCIPLES.....	64
6.3	REFERENCE MATERIALS.....	64
6.4	CHECKING THE ANALYTICAL SERIES.....	66
6.4.1	Definition.....	66
6.4.2	Checking accuracy using reference materials.....	66
6.4.3	Intraserie precision.....	66
6.4.4	Internal standard.....	67
6.5	CHECKING THE ANALYSIS SYSTEM.....	67
6.5.1	Definition.....	67
6.5.2	Shewhart chart.....	67
6.5.2.1	Data acquisition.....	67
6.5.2.2	Presentation of results and definition of limits.....	68
6.5.2.3	Using the Shewhart chart.....	69
6.5.3	Internal comparison of analysis systems.....	70
6.5.4	External comparison of the analysis system.....	70
6.5.4.1	Analysis chain of interlaboratory comparisons.....	70
6.5.4.2	Comparison with external reference materials.....	70
6.5.4.2.1	Standard uncertainty of reference material.....	71
6.5.4.2.2	Defining the validity limits of measuring reference material.....	71
7.	ASSESSMENT OF MEASUREMENT UNCERTAINTY.....	72
7.1	DEFINITION.....	72
7.2	REFERENCE DOCUMENTS.....	73
7.3	SCOPE.....	73
7.4	METHODOLOGY.....	74

**COMPENDIUM OF INTERNATIONAL ANALYSIS OF METHODS -
OIV**

Guide for the validation – quality control

7.4.1	<i>Definition of the measurand, and description of the quantitative analysis method</i>	74
7.4.2	<i>Critical analysis of the measurement process</i>	75
7.4.3	<i>Estimation calculations of standard uncertainty (intralaboratory approach)</i>	75
7.4.3.1	Principle.....	75
7.4.3.2	Calculating the standard deviation of intralaboratory reproducibility.....	78
7.4.3.3	Estimating typical sources of systematic errors not taken into account under reproducibility conditions.....	79
7.4.3.3.1	Gauging error (or calibration error).....	79
7.4.3.3.1.1	Procedure.....	79
7.4.3.3.1.2	Calculations and results.....	80
7.4.3.3.1.3	Estimating the standard uncertainty associated the gauging line (or calibration line).....	81
7.4.3.3.2	Bias error.....	82
7.4.3.3.2.1	Methods adjusted with only one certified reference material.....	82
7.4.3.3.2.2	Methods adjusted with several reference materials (gauging ranges etc)	82
7.4.3.3.3	Matrix effect.....	83
7.4.3.3.3.1	Definition.....	83
7.4.3.3.4	Sample effect.....	86
7.4.4	<i>Estimating standard uncertainty by interlaboratory tests</i>	86
7.4.4.1	Principle.....	86
7.4.4.2	Using the standard deviation of interlaboratory and intramethod reproducibility SR_{inter} (method).....	87
7.4.4.3	Using the standard deviation of interlaboratory and intermethod reproducibility SR_{inter}	87
7.4.4.4	Other components in the uncertainty budget.....	88
7.5	EXPRESSING EXPANDED UNCERTAINTY.....	88

1. Purpose

The purpose of this guide is to assist oenological laboratories carrying out serial analysis as part of their validation, internal quality control and uncertainty assessment initiatives concerning the standard methods they use.

2. Preamble and scope

International standard ISO 17025, defining the "General Requirements for the Competence of Testing and Calibration Laboratories", states that the accredited laboratories must, when implementing an alternative analytical method, make sure of the quality of the results obtained. To do so, it indicates several steps. The first step consists in defining the customers' requirements concerning the parameter in question, in order to determine, thereafter, whether the method used meets those requirements. The second step includes initial validation for non-standardized, modified or laboratory-developed methods. Once the method is applied, the laboratories must use inspection and traceability methods in order to monitor the quality of the results obtained. Finally, they must assess the uncertainty of the results obtained.

In order to meet these requirements, the laboratories have a significant reference system at their disposal comprising a large number of international guides and standards. However, in practice, the application of these texts is delicate since, because they address every category of calibration and test laboratory, they remain very general and presuppose, on behalf of the reader, in-depth knowledge of the mathematical rules applicable to statistical data processing.

This guide is based on this international reference system, taking into account the specific characteristics of oenology laboratories routinely carrying out analyses on series of must or wine samples. Defining the scope of application in this way enabled a relevant choice of suitable tools to be made, in order to retain only those methods most suitable for that scope. Since it is based on the international reference system, this guide is therefore strictly compliant with it. Readers, however, wishing to study certain points of the guide in greater detail can do so by referring to the international standards and guides, the references for which are given in each chapter.

The authors have chosen to combine the various tools meeting the requirements of the ISO 17025 standard since there is an obvious solution of continuity in their

application, and the data obtained with certain tools can often be used with the others. In addition, the mathematical resources used are often similar.

The various chapters include application examples, taken from oenology laboratories using these tools.

It is important to point out that that this guide does not pretend to be exhaustive. It is only designed to present, in as clear and applicable a way as possible, the contents of the requirements of the ISO 17025 standard and the basic resources that can be implemented in a routine laboratory to meet them. Each laboratory remains perfectly free to supplement these tools or to replace them by others that they consider to be more efficient or more suitable.

Finally, the reader's attention should be drawn to the fact that the tools presented do not constitute an end in themselves and that their use, as well as the interpretation of the results to which they lead, must always be subject to critical analysis. It is only under these conditions that their relevance can be guaranteed, and laboratories will be able to use them as tools to improve the quality of the analyses they carry out.

3. General vocabulary

The definitions indicated below used in this document result from the normative references given in the bibliography.

Analyte

Object of the analysis method

Blank

Test carried out in the absence of a matrix (reagent blank) or on a matrix which does not contain the analyte (matrix blank).

Bias

Difference between the expected test results and an accepted reference value.

Uncertainty budget

The list of uncertainty sources and their associated standard uncertainties, established in order to assess the compound standard uncertainty associated with a measurement result.

Gauging (of a measuring instrument)

Material positioning of each reference mark (or certain principal reference marks only) of a measuring instrument according to the corresponding value of the measurand.

NOTE "gauging" and "calibration" are not be confused

Repeatability conditions

Conditions where independent test results are obtained with the same method on identical test items in the same laboratory by the same operator using the same equipment within short intervals of time.

Reproducibility conditions (intralaboratory)

Conditions where independent test results are obtained with the same method on identical test items in the same laboratory by the same or different operator(s) using different gauges on different days.

Experimental standard deviation

For a series of n measurements of the same measurand, the quantity s characterizing the dispersion of the results and given by the formula:

$$s = \sqrt{\frac{\sum_{i=1}^n (x_i - \bar{x})^2}{n - 1}}$$

x_i being the result of the measurement i^{th} and \bar{x} the arithmetic mean of the n results considered.

Repeatability standard deviation

Standard deviation of many repetitions obtained in a single laboratory by the same operator on the same instrument, i.e. under repeatable conditions.

Internal reproducibility standard deviation (or total intralaboratory variability)

Standard deviation of repetitions obtained in a single laboratory with the same method, using several operators or instruments and, in particular, by taking measurements on different dates, i.e. under reproducibility conditions.

Random error

Result of a measurement minus the mean that would result from an infinite number of measurements of the same measurand carried out under reproducibility conditions.

Measurement error

Result of a measurement minus a true value of the measurand.

Systematic error

Mean error that would result from an infinite number of measurements of the same measurand carried out under reproducibility conditions minus a true value of the measurand.

NOTE Error is a highly theoretical concept in that it calls upon values that are not accessible in practice, in particular the true values of measurands. On principle, the error is unknown.

Mathematical expectation

For a series of n measurements of the same measurand, if n tends towards the infinite, the mean \bar{x} tends towards the expectation $E(x)$.

$$E(x) = \lim_{n \rightarrow \infty} \frac{\sum_{i=1}^n x_i}{n}$$

Calibration

Series of operations establishing under specified conditions the relation between the values of the quantity indicated by a measuring instrument or system, or the values represented by a materialized measurement or a reference material, and the corresponding values of the quantity measured by standards.

Intralaboratory evaluation of an analysis method

Action which consists in submitting an analysis method to an intralaboratory statistical study, based on a standardized and/or recognized protocol, demonstrating that within its scope, the analysis method meets pre-established performance criteria.

Within the framework of this document, the evaluation of a method is based on an intralaboratory study, which includes the comparison with a reference method.

Precision

Closeness of agreement between independent test results obtained under prescribed conditions

NOTE 1 Precision depends only on the distribution of random errors and does not have any relationship with the true or specified value.

NOTE 2 The measurement of precision is expressed on the basis of the standard deviation of the test results.

NOTE 3 The expression "independent test results" refers to results obtained such that they are not influenced by a previous result on the same or a similar test material. Quantitative measurements of precision are critically dependent upon the prescribed conditions. Repeatability and reproducibility conditions are particular sets of extreme conditions.

Quantity (measurable)

An attribute of a phenomenon, body or substance that may be distinguished qualitatively and determined quantitatively.

Uncertainty of measurement

A parameter associated with the result of a measurement, which characterizes the dispersion of the values that could reasonably be attributed to the measurand.

Standard uncertainty ($u(x_i)$)

Uncertainty of the result of a measurement expressed in the form of a standard deviation.

Accuracy

Closeness of agreement between the mean value obtained starting from a broad series of test results and an accepted reference value.

NOTE The measurement of accuracy is generally expressed in terms of bias.

Detection limit

Lowest amount of an analyte to be examined in a test material that can be detected and regarded as different from the blank value (with a given probability), but not necessarily quantified. In fact, two risks must be taken into account:

- the risk α of considering the substance is present in test material when its quantity is null;
- the risk β of considering a substance is absent from a substance when its quantity is not null.

Quantification limit

Lowest amount of an analyte to be examined in a test material that can be quantitatively determined under the experimental conditions described in the method with a defined variability (given coefficient of variation).

Linearity

The ability of a method of analysis, within a certain range, to provide an instrumental response or results proportional to the quality of analyte to be determined in the laboratory sample.

This proportionality is expressed by an a priori defined mathematical expression. The linearity limits are the experimental limits of concentrations between which a linear calibration model can be applied with a known confidence level (generally taken to be equal to 1%).

Test material

Material or substance to which a measuring can be applied with the analysis method under consideration.

Reference material

Material or substance one or more of whose property values are sufficiently homogeneous and well established to be used for the calibration of an apparatus, the assessment of a measurement method, or for assigning values to materials.

Certified reference material

Reference material, accompanied by a certificate, one or more whose property values are certified by a procedure which establishes its traceability to an accurate realization of the unit in which the property values are expressed, and for which each certified value is accompanied by an uncertainty at a stated level of confidence.

Matrix

All the constituents of the test material other than the analyte.

Analysis method

Written procedure describing all the means and procedures required to carry out the analysis of the analyte, i.e.: scope, principle and/or reactions, definitions, reagents, apparatus, procedures, expression of results, precision, test report.

WARNING The expressions "titration method" and "determination method" are sometimes used as synonyms for the expression "analysis method". These two expressions should not be used in this way.

Quantitative analysis method

Analysis method making it possible to measure the analyte quantity present in the laboratory test material.

Reference analysis method (Type I or Type II methods)

Method, which gives the accepted reference value for the quantity of the analyte to be measured.

Non-classified alternative method of analysis

A routine analysis method used by the laboratory and not considered to be a reference method.

NOTE An alternative method of analysis can consist in a simplified version of the reference method.

Measurement

Set of operations having the object of determining a value of a quantity.

NOTE The operations can be carried out automatically.

Measurand

Particular quantity subject to measurement.

Mean

For a series of n measurements of the same measurand, mean value, given by the formula:

$$\bar{x} = \frac{\sum_{i=1}^n x_i}{n}$$

x_i being the result of the i^{th} measurement.

Result of a measurement

Value assigned to a measurand, obtained by measurement

Sensitivity

Ratio between the variation of the information value of the analysis method and the variation of the analyte quantity.

The variation of the analyte quantity is generally obtained by preparing various standard solutions, or by adding the analyte to a matrix.

NOTE 1 Defining, by extension, the sensitivity of a method as its capacity to detect small quantities should be avoided.

NOTE 2 A method is said to be "sensitive" if a low variation of the quantity or analyte quantity incurs a significant variation in the information value.

Measurement signal

Quantity representing the measurand and is functionally linked to it.

Specificity

Property of an analysis method to respond exclusively to the determination of the quantity of the analyte considered, with the guarantee that the measured signal comes only from the analyte.

Tolerance

Deviation from the reference value, as defined by the laboratory for a given level, within which a measured value of a reference material can be accepted.

Value of a quantity

Magnitude of a particular quantity generally expressed as a unit of measurement multiplied by a number.

True value of a quantity

Value compatible with the definition of a given particular quantity.

NOTE 1 The value that would be obtained if the measurement was perfect

NOTE 2 Any true value is by nature indeterminate

Accepted reference value

A value that serves as an agreed-upon reference for comparison and which is derived as:

- a) a theoretical or established value, based on scientific principles;
- b) an assigned or certified value, based on experimental work of some national or international organization;
- c) a consensus or certified value, based on collaborative experimental work under the auspices of a scientific or engineering group;

Within the particular framework of this document, the accepted reference value (or conventionally true value) of the test material is given by the arithmetic mean of the values of measurements repeated as per the reference method.

Variance

Square of the standard deviation.

4. General principles

4.1 Methodology

**COMPENDIUM OF INTERNATIONAL ANALYSIS OF METHODS -
OIV
Guide for the validation – quality control**

When developing a new alternative method, the laboratory implements a protocol that includes several steps. The first step, applied only once at the initial stage, or on a regular basis, is the validation of the method. This step is followed by permanent quality control. All the data collected during these two steps make it possible to assess the quality of the method. **The data collected during these two steps are used to evaluate the measurement uncertainty.** The latter, which is regularly assessed, is an indicator of the quality of the results obtained by the method under consideration.

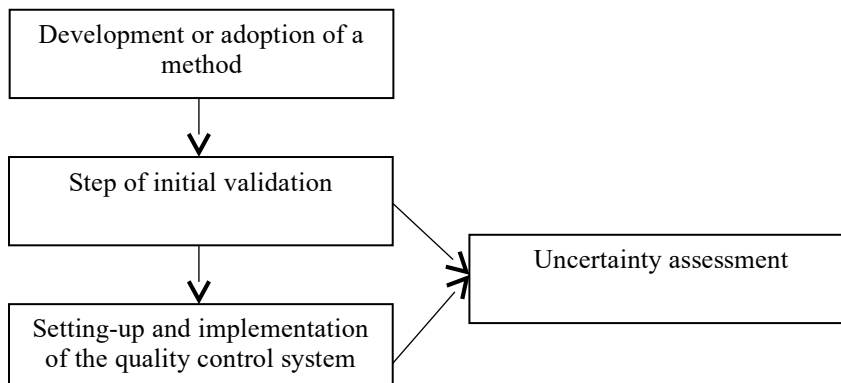

All these steps are inter-connected and constitute a global approach that can be used to assess and control measurement errors.

4.2 Definition of measurement error

Any measurement carried out using the method under study gives a result which is inevitably associated with a measurement error, defined as being the difference between the result obtained and the true value of the measurand. In practice, **the true value of the measurand is inaccessible** and a value conventionally accepted as such is used instead.

The measurement error includes two components:

Measurement error

$$\text{True value} = \text{Analysis result} + \text{Systematic error} + \text{Random error}$$

In practice, the systematic error results in a bias in relation to the true value, the random error being all the errors associated with the application of the method.

These errors can be graphically represented in the following way:

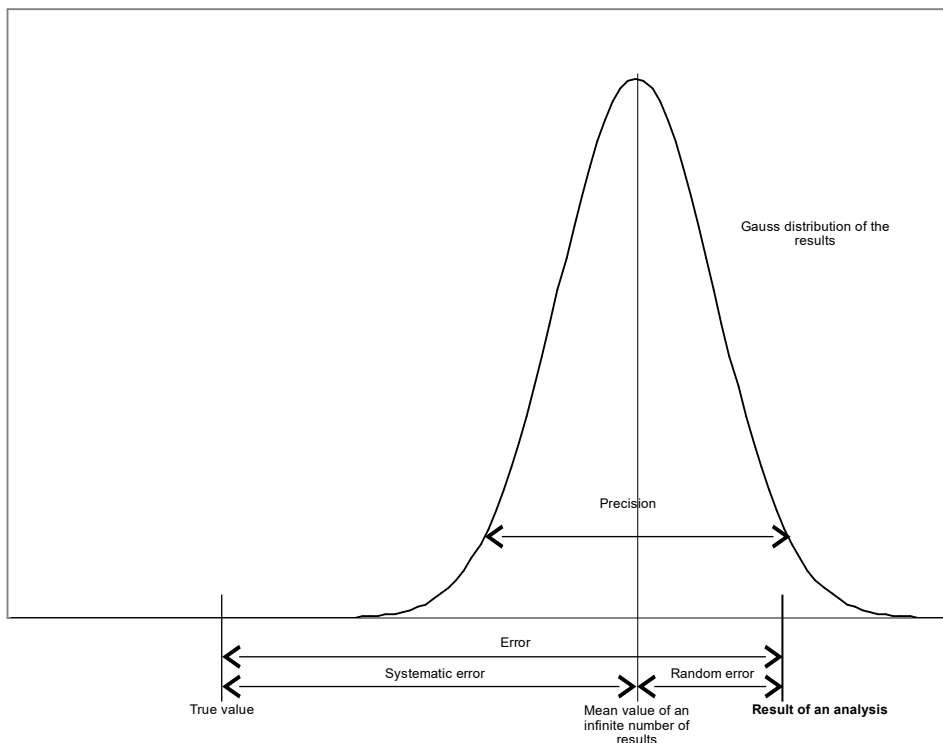

The validation and quality control tools are used to evaluate the systematic errors and the random errors, and to monitor their changes over time.

5. Validating a method

5.1 Methodology

**COMPENDIUM OF INTERNATIONAL ANALYSIS OF METHODS -
OIV**

Guide for the validation – quality control

Implementing the validation comprises 3 steps, each with objectives. To meet these objectives, the laboratory has validation tools. Sometimes there are many tools for a given objective, and are suitable for various situations. It is up to the laboratory to correctly choose the most suitable tools for the method to be validated.

**COMPENDIUM OF INTERNATIONAL ANALYSIS OF METHODS -
OIV
Guide for the validation – quality control**

<u>Steps</u>	<u>Objectives</u>	<u>Tools for validation</u>
Scope of application	<ul style="list-style-type: none"> - To define the analyzable matrices - To define the analyzable range 	<ul style="list-style-type: none"> Detection and quantification limit Robustness study
Systematic error or bias	<ul style="list-style-type: none"> - Linear response in the scale of analyzable values - Specificity of the method - Accuracy of the method 	<ul style="list-style-type: none"> Linearity study Specificity study Comparison with a reference method Comparison with reference materials Interlaboratory comparison
Random error	<ul style="list-style-type: none"> - Precision of the method 	<ul style="list-style-type: none"> Repeatability study Intralaboratory reproducibility study

5.2 Section one: Scope of method

5.2.1 *Definition of analyzable matrices*

The matrix comprises all constituents in the test material other than the analyte. If these constituents are liable to influence the result of a measurement, the laboratory should define the matrices on which the method is applicable.

For example, in oenology, the determination of certain parameters can be influenced by the various possible matrices (wines, musts, sweet wines, etc.).

In case of doubt about a matrix effect, more in-depth studies can be carried out as part of the specificity study.

5.2.2 *Detection and quantification limit*

This step is of course not applicable and not necessary for those methods whose lower limit does not tend towards 0, such as alcoholic strength by volume in wines, total acidity in wines, pH, etc.

5.2.2.1 Normative definition

The detection limit is the lowest amount of analyte that can be detected but not necessarily quantified as an exact value. The detection limit is a parameter of limit tests.

The quantification limit is the lowest quantity of the compound that can be determined using the method.

5.2.2.2 Reference documents

- NF V03-110 Standard, intralaboratory validation procedure for an alternative method in relation to a reference method.
- International compendium of analysis methods – OIV, Assessment of the detection and quantification limit of an analysis method (Oeno resolution 7/2000).

5.2.2.3 Application

In practice, the quantification limit is generally more relevant than the detection limit, the latter being by convention 1/3 of the first.

There are several approaches for assessing the detection and quantification limits:

- Determination on blank
- Approach by the linearity study
- Graphic approach

These methods are suitable for various situations, but in every case they are mathematical approaches giving results of informative value only. It seems crucial, whenever possible, to introduce a check of the value obtained, whether by one of these approaches or estimated empirically, using the checking protocol for a predetermined quantification limit.

5.2.2.4 Procedure

5.2.2.4.1 Determination on blank

5.2.2.4.1.1 Scope

**COMPENDIUM OF INTERNATIONAL ANALYSIS OF METHODS -
OIV
Guide for the validation – quality control**

This method can be applied when the blank analysis gives results with a non-zero standard deviation. The operator will judge the advisability of using reagent blanks, or matrix blanks.

If the blank, for reasons related to uncontrolled signal preprocessing, is sometimes not measurable or does not offer a recordable variation (standard deviation of 0), the operation can be carried out on a very low concentration in analyte, close to the blank.

5.2.2.4.1.2 *Basic protocol and calculations*

Carry out the analysis of *n* test materials assimilated to blanks, *n* being equal to or higher than 10.

- Calculate the mean of the x_i results obtained:

$$\bar{x}_{blank} = \frac{\sum_{i=1}^n x_i}{n}$$

- Calculate the standard deviation of the x_i results obtained:

$$S_{blank} = \sqrt{\frac{\sum_{i=1}^n (x_i - \bar{x}_{blank})^2}{n-1}}$$

- From these results the detection limit is conventionally defined by the formula:

$$L_d = \bar{x}_{blank} + (3 \cdot S_{blank})$$

- From these results the quantification limit is conventionally defined by the formula:

$$L_q = \bar{x}_{blank} + (10 \cdot S_{blank})$$

Example: The table below gives some of the results obtained when assessing the detection limit for the usual determination of free sulfur dioxide.

<i>Test material #</i>	<i>X</i>
------------------------	----------

**COMPENDIUM OF INTERNATIONAL ANALYSIS OF METHODS -
OIV
Guide for the validation – quality control**

	(mg/l)
1	0
2	1
3	0
4	1.5
5	0
6	1
7	0.5
8	0
9	0
10	0.5
11	0
12	0

The calculated values are as follows:

$$q = 12$$

$$M_{blank} = 0.375$$

$$S_{blank} = 0.528 \text{ mg/l}$$

$$DL = 1.96 \text{ mg/l}$$

$$QL = 5.65 \text{ mg/l}$$

5.2.2.4.2 Approach by linearity study

5.2.2.4.2.1 Scope

This method can be applied in all cases, and is required when the analysis method does not involve background noise. It uses the data calculated during the linearity study.

NOTE This statistical approach may be biased and give pessimistic results when linearity is calculated on a very wide range of values for reference materials, and whose measurement results include variable standard deviations. In such cases, a linearity study limited to a range of low values, close to 0 and with a more homogeneous distribution will result in a more relevant assessment.

5.2.2.4.2.2 *Basic protocol and calculations*

Use the results obtained during the linearity study which made it possible to calculate the parameters of the calibration function $y = a + b \cdot x$

The data to be recovered from the linearity study are (see chapter 5.3.1. linearity study):

- slope of the regression line:

$$b = \frac{\sum_{i=1}^n (x_i - M_x)(y_i - M_y)}{\sum_{i=1}^n (x_i - M_x)^2}$$

- residual standard deviation:

$$S_{res} = \sqrt{\frac{\sum_{i=1}^n \sum_{j=1}^p (y_{i,j} - \hat{y}_{i,j})^2}{pn - 2}}$$

- standard deviation at the intercept point (to be calculated):

$$S_a = S_{res} \sqrt{\left(\frac{1}{np} + \frac{M_x^2}{\sum_{i=1}^n p (x_i - M_x)^2} \right)}$$

The estimates of the detection limit **DL** and the quantification limit **QL** are calculated using following formulae:

$$DL = \frac{3 \times S_a}{b} \quad \text{Estimated detection limit}$$

$$QL = \frac{10 \times S_a}{b} \quad \text{Estimated quantification limit}$$

**COMPENDIUM OF INTERNATIONAL ANALYSIS OF METHODS -
OIV
Guide for the validation – quality control**

Example: Estimation of the detection and quantification limits in the determination of sorbic acid by capillary electrophoresis, based on linearity data acquired on a range from 1 to 20 mg.L⁻¹.

X (ref)	Y1	Y2	Y3	Y4
1	1.9	0.8	0.5	1.5
2	2.4	2	2.5	2.1
3	4	2.8	3.5	4
4	5.3	4.5	4.7	4.5
5	5.3	5.3	5.2	5.3
10	11.6	10.88	12.1	10.5
15	16	15.2	15.5	16.1
20	19.7	20.4	19.5	20.1

Number of reference materials

$$n = 8$$

Number of replicas

$$p = 4$$

Straight line ($y = a + b \cdot x$)

$$b = 0.9972$$

$$a = 0.51102$$

residual standard deviation:

$$S_{res} = 0.588$$

Standard deviation on the intercept

point

$$S_a = 0.1597$$

The estimated detection limit is $DL = 0.48 \text{ mg.L}^{-1}$

The estimated quantification limit is $QL = 1.6 \text{ mg.L}^{-1}$

**COMPENDIUM OF INTERNATIONAL ANALYSIS OF METHODS -
OIV
Guide for the validation – quality control**

5.2.2.4.3 Graphic approach based on the background noise of the recording

5.2.2.4.3.1 Scope

This approach can be applied to analysis methods that provide a graphic recording (chromatography, etc.) with a background noise. The limits are estimated from a study of the background noise.

5.2.2.4.3.2 Basic protocol and calculation

Record a certain number of reagent blanks, using 3 series of 3 injections separated by several days.

Determine the following values:

- h_{\max} the greatest variation in amplitude on the y-axis of the signal observed between two acquisition points, excluding drift, at a distance equal to twenty times the width at mid-height of the peak corresponding to the analyte, centered over the retention time of the compound under study.
- R, the quantity/signal response factor, expressed in height.

The detection limit **DL**, and the quantification limit **QL** are calculated according to the following formulae:

$$DL = 3 h_{\max} R \qquad QL = 10 h_{\max} R$$

5.2.2.4.4 Checking a predetermined quantification limit

This approach can be used to validate a quantification value obtained by statistical or empirical approach.

5.2.2.4.4.1 Scope

This method can be used to check that a given quantification limit is *a priori* acceptable. It is applicable when the laboratory can procure at least 10 test materials with known quantities of analyte, at the level of the estimated quantification limit.

In the case of methods with a specific signal, not sensitive to matrix effects, the materials can be synthetic solutions whose reference value is obtained by formulation.

In all other cases, wines (or musts) shall be used whose measurand value as obtained by the reference method is equal to the limit to be studied. Of course, in this case the quantification limit of the reference method must be lower than this value.

5.2.2.4.4.2 *Basic protocol and calculation*

Analyze n independent test materials whose accepted value is equal to the quantification limit to be checked; n must at least be equal to 10.

- Calculate the mean of n measurements:

$$\bar{x}_{LQ} = \frac{\sum_{i=1}^n x_i}{n}$$

- Calculate the standard deviation of n measurements:

$$S_{LQ} = \sqrt{\frac{\sum_{i=1}^n (x_i - \bar{x}_{LQ})^2}{n-1}}$$

with x_i results of the measurement of the i^{th} test material.

The two following conditions must be met:

a) the measured mean quantity \bar{x}_{LQ} must not be different from the predetermined quantification limit QL :

$$\text{If } \frac{|\overline{QL} - \bar{x}_{QL}|}{\frac{S_{QL}}{\sqrt{n}}} < 10 \text{ then quantification limit } QL \text{ is considered to be valid.}$$

NOTE 10 is a purely conventional value relating to the QL criterion.

b) the quantification limit must be other than 0:

If $5 S_{QL} < QL$ then the quantification limit is other than 0.

**COMPENDIUM OF INTERNATIONAL ANALYSIS OF METHODS -
OIV**

Guide for the validation – quality control

A value of 5 corresponds to an approximate value for the spread of the standard deviation, taking into account risk α and risk β to ensure that the QL is other than 0.

This is equivalent to checking that the coefficient of variation for QL is lower than 20%.

NOTE1 Remember that the detection limit is obtained by dividing the quantification limit by 3.

NOTE2 A check should be made to ensure that the value of S_{LQ} is not too large (which would produce an artificially positive test), and effectively corresponds to a reasonable standard deviation of the variability of the results for the level under consideration. It is up to the laboratory to make this critical evaluation of the value of S_{LQ} .

Example: Checking the quantification limit of the determination of malic acid by the enzymatic method.

Estimated quantification limit: 0.1 g.L⁻¹

Wine	Values
1	0.1
2	0.1
3	0.09
4	0.1
5	0.09
6	0.08
7	0.08
8	0.09
9	0.09
10	0.08

Mean: 0.090

Standard deviation: 0.008

First condition:
$$\frac{|LQ - \bar{x}_{QL}|}{\frac{S_{QL}}{\sqrt{n}}} = 3.87 < 10$$
 The

quantification limit of 0.1 is considered to be valid.

Second condition: $5.S_{LQ}=0.04<0.1$ The quantification limit is considered to be significantly different from 0.

5.2.3 *Robustness*

5.2.3.1 *Definition*

Robustness is the capacity of a method to give close results in the presence of slight changes in the experimental conditions likely to occur during the use of the procedure.

5.2.3.2 *Determination*

If there is any doubt about the influence of the variation of operational parameters, the laboratory can use the scientific application of experiment schedules, enabling these critical operating parameters to be tested within the variation range likely to occur under practical conditions. In practice, these tests are difficult to implement.

5.3 Section two: systematic error study

5.3.1 *Linearity study*

5.3.1.1 *Normative definition*

The linearity of a method is its ability (within a given range) to provide an informative value or results proportional to the amount of analyte to be determined in the test material.

5.3.1.2 *Reference documents*

- NF V03-110 standard. Intralaboratory validation procedure of an alternative method in relation to a reference method.
- ISO 11095 Standard, linear calibration using reference materials.
- ISO 8466-1 Standard, Water quality – Calibration and evaluation of analytical methods and estimation of performance characteristics

5.3.1.3 *Application*

The linearity study can be used to define and validate a linear dynamic range.

This study is possible when the laboratory has stable reference materials whose accepted values have been acquired with certainty (in theory these values should have an uncertainty equal to 0). These could therefore be internal reference materials titrated with calibrated material, wines or musts whose value is given by the mean of at least 3 repetitions of the reference method, external reference materials or certified external reference materials.

In the last case, and only in this case, this study also enables the traceability of the method. The experiment schedule used here could then be considered as a calibration.

In all cases, it is advisable to ensure that the matrix of the reference material is compatible with the method.

Lastly, calculations must be made with the final result of the measurement and not with the value of the signal.

Two approaches are proposed here:

- An ISO 11095 type of approach, the principle of which consists in comparing the residual error with the experimental error using a Fischer's test. This approach is valid above all for relatively narrow ranges (in which the measurand does not vary by more than a factor 10). In addition, under experimental conditions generating a low reproducibility error, the test becomes excessively severe. On the other hand, in the case of poor experimental conditions, the test will easily be positive and will also lose its relevance. This approach requires good homogeneity of the number of measurements over the entire range studied.
- An ISO 8466 type of approach, the principle of which consists in comparing the residual error caused by the linear regression with the residual error produced by a polynomial regression (of order 2 for example) applied to the same data. If the polynomial model gives a significantly lower residual error, a conclusion of nonlinearity could be drawn. This approach is appropriate in particular when there is a risk of high experimental dispersion at one end of the range. It is therefore naturally well-suited to analysis methods for traces. There is no need to work with a homogeneous number of measurements over the whole range, and it is even recommended to increase the number of measurements at the borders of the range.

5.3.1.4 ISO 11095-type approach

5.3.1.4.1 Basic protocol

It is advisable to use a number *n* of reference materials. The number must be higher than 3, but there is no need, however, to exceed 10. The reference materials should be measured *p* times, under **reproducibility conditions**, *p* shall be higher than 3, a number of 5 being generally recommended. The accepted values for the reference materials are to be regularly distributed over the studied range of values. The number of measurements must be identical for all the reference materials.

NOTE It is essential that the reproducibility conditions use a maximum of potential sources of variability, with the risk that the test shows non-linearity in an excessive way.

The results are reported in a table presented as follows:

Reference materials	Accepted reference value material	Measured values				
		Replica 1	...	Replica j	...	Replica p
<i>l</i>	x_l	y_{l1}	...	y_{lj}	...	y_{lp}
...
<i>i</i>	x_i	y_{i1}	...	y_{ij}	...	y_{ip}
...
<i>n</i>	x_n	y_{n1}	...	y_{nj}	...	y_{np}

5.3.1.4.2 Calculations and results

5.3.1.4.2.1 Defining the regression model

The model to be calculated and tested is as follows:

$$y_{ij} = a + b \cdot x_i + \varepsilon_{ij}$$

where

- y_{ij} is the *j*th replica of the *i*th reference material.
- x_i is the accepted value of the *i*th reference material.
- b* is the slope of the regression line.

a is the intercept point of the regression line.
 $a+b.x_i$ represents the expectation of the measurement value of the i^{th} reference material.

ε_{ij} is the difference between y_{ij} and the expectation of the measurement value of the i^{th} reference material.

5.3.1.4.2.2 Estimating parameters

The parameters of the regression line are obtained using the following formulae:

- mean of p measurements of the i^{th} reference material

$$y_i = \frac{1}{p} \sum_{j=1}^p y_{ij}$$

- mean of all the accepted values of n reference materials

$$M_x = \frac{1}{n} \sum_{i=1}^n x_i$$

- mean of all the measurements

$$M_y = \frac{1}{n} \sum_{i=1}^n y_i$$

- estimated slope b

$$b = \frac{\sum_{i=1}^n (x_i - M_x)(y_i - M_y)}{\sum_{i=1}^n (x_i - M_x)^2}$$

- estimated intercept point a

$$a = M_y - b \times M_x$$

- regression value associated with the i^{th} reference material \hat{y}_i

$$\hat{y}_i = a + b \times x_i$$

- residual e_{ij}

$$e_{ij} = y_{ij} - \hat{y}_i$$

**COMPENDIUM OF INTERNATIONAL ANALYSIS OF METHODS -
OIV**

Guide for the validation – quality control

5.3.1.4.2.3 *Charts*

The results can be presented and analyzed in graphic form. Two types of charts are used.

- The first type of graph is the representation of the values measured against the accepted values of reference materials. The calculated overlap line is also plotted.

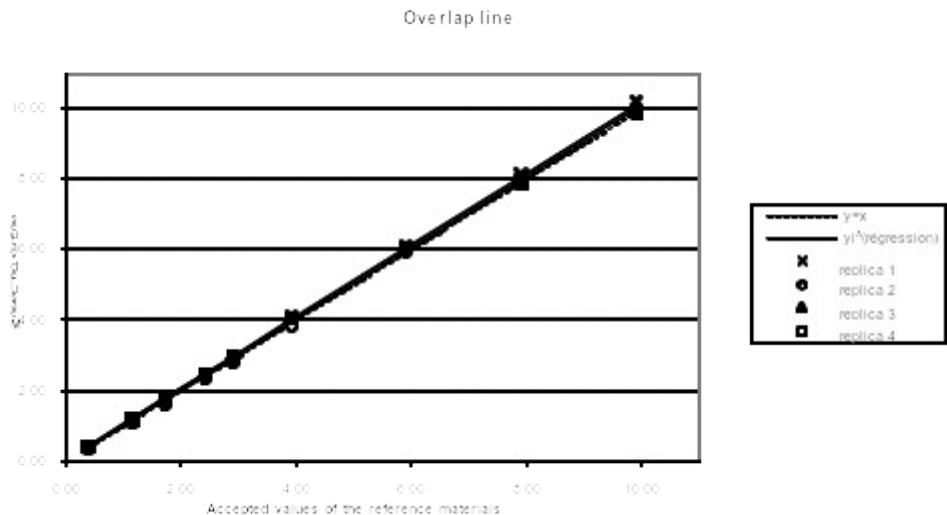

- The second graph is the representation of the residual values against the estimated values of the reference materials (\hat{y}) indicated by the overlap line.

The graph is a good indicator of the deviation in relation to the linearity assumption: the linear dynamic range is valid if the residual values are fairly distributed between the positive and negative values.

**COMPENDIUM OF INTERNATIONAL ANALYSIS OF METHODS -
OIV
Guide for the validation – quality control**

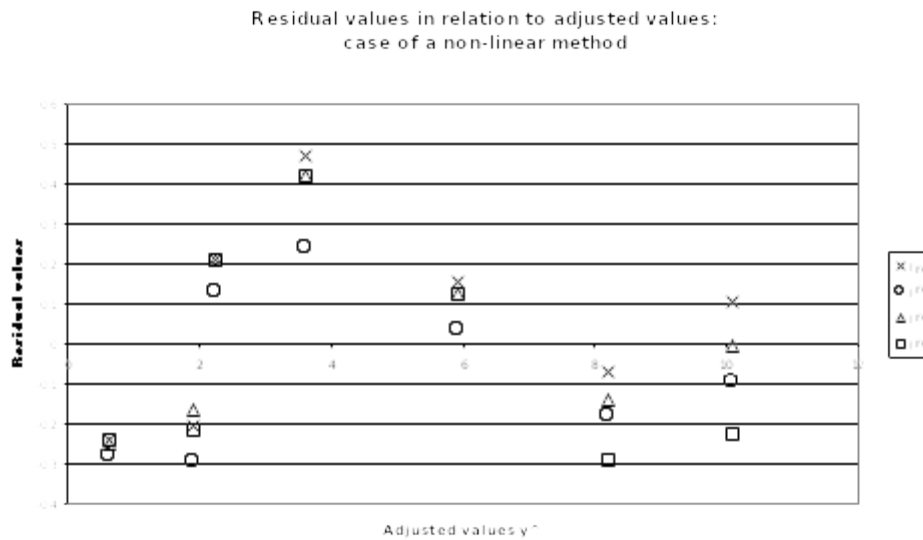
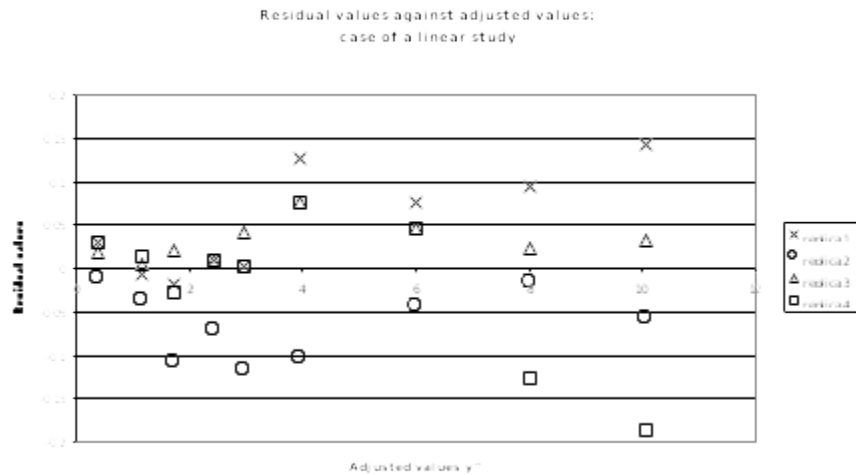

In case of doubt about the linearity of the regression, a Fischer-Snedecor test can be carried out in order to test the assumption: "the linear dynamic range is not valid", in addition to the graphic analysis.

5.3.1.4.2.4 Test of the linearity assumption

Several error values linked to calibration should be defined first of all: these can be estimated using the data collected during the experiment. A statistical test is then

performed on the basis of these results, making it possible to test the assumption of non-validity of the linear dynamic range: this is the Fischer-Snedecor test.

5.3.1.4.2.4.1 Definitions of errors linked to calibration

These errors are given as a standard deviation, resulting from the square root of the ratio between a sum of squares and a degree of freedom.

Residual error

The residual error corresponds to the error between the measured values and the value given by the regression line.

The sum of the squares of the residual error is as follows:

$$Q_{res} = \sum_{i=1}^n \sum_{j=1}^p (y_{ij} - \hat{y}_i)^2$$

The number of degrees of freedom is $np-2$.

The residual standard deviation is then estimated by the formula:

$$S_{res} = \sqrt{\frac{\sum_{i=1}^n \sum_{j=1}^p (y_{ij} - \hat{y}_i)^2}{np - 2}}$$

Experimental error

The experimental error corresponds to the reproducibility standard deviation of the experimentation.

The sum of the squares of the experimental error is as follows:

$$Q_{exp} = \sum_{i=1}^n \sum_{j=1}^p (y_{ij} - y_i)^2$$

The number of degrees of freedom is $np-n$.

The experimental standard deviation (reproducibility) is then estimated by the formula:

$$S_{exp} = \sqrt{\frac{\sum_{i=1}^n \sum_{j=1}^p (y_{ij} - y_i)^2}{np - n}}$$

NOTE This quantity is sometimes also noted S_R .

Adjustment error

The value of the adjustment error is the experimental error minus the residual error.

The sum of the squares of the adjustment error is:

$$Q_{def} = Q_{res} - Q_{exp}$$

or

$$Q_{def} = \sum_{i=1}^n \sum_{j=1}^p (y_{ij} - \hat{y}_i)^2 - \sum_{i=1}^n \sum_{j=1}^p (y_{ij} - y_i)^2$$

The number of degrees of freedom is $n-2$

**COMPENDIUM OF INTERNATIONAL ANALYSIS OF METHODS -
OIV
Guide for the validation – quality control**

The standard deviation of the adjustment error is estimated by the formula:

$$S_{def} = \sqrt{\frac{Q_{res} - Q_{exp}}{n - 2}}$$

or

$$S_{def} = \sqrt{\frac{\sum_{i=1}^n \sum_{j=1}^p (y_{ij} - \hat{y}_i)^2 - \sum_{i=1}^n \sum_{j=1}^p (y_{ij} - y_i)^2}{n - 2}}$$

5.3.1.4.2.4.2 Fischer-Snedecor test

The ratio $F_{obs} = \frac{S_{def}^2}{S_{exp}^2}$ obeys the Fischer-Snedecor law with the degrees of freedom $n-2, np-n$.

The calculated experimental value F_{obs} is compared with the limit value: $F_{1-\alpha}(n-2, np-n)$, extracted from the Snedecor law table. The value for α used in practice is generally 5%.

If $F_{obs} \geq F_{1-\alpha}$ the assumption of the non-validity of the linear dynamic range is accepted (*with a risk of α error of 5%*).

If $F_{obs} < F_{1-\alpha}$ the assumption of the non-validity of the linear dynamic range is rejected

Example: Linearity study for the determination of tartaric acid by capillary electrophoresis. 9 reference materials are used. These are synthetic solutions of tartaric acid, titrated by means of a scale traceable to standard masses.

Ref. material	Ti (ref)	Y1	Y2	Y3	Y4
1	0.38	0.41	0.37	0.4	0.41
2	1.15	1.15	1.12	1.16	1.17
3	1.72	1.72	1.63	1.76	1.71
4	2.41	2.45	2.37	2.45	2.45
5	2.91	2.95	2.83	2.99	2.95
6	3.91	4.09	3.86	4.04	4.04
7	5.91	6.07	5.95	6.04	6.04

**COMPENDIUM OF INTERNATIONAL ANALYSIS OF METHODS -
OIV**

Guide for the validation – quality control

8	7.91	8.12	8.01	8.05	7.9
9	9.91	10.2	10	10.09	9.87

Regression line

Line ($y = a + b \cdot x$)

$b = 1.01565$

$a = - 0.00798$

Errors related to calibration

Residual standard deviation $S_{res} = 0.07161$

Standard deviation of experimental reproducibility $S_{exp} = 0.07536$

Standard deviation of the adjustment error $S_{def} = 0.0548$

Interpretation, Fischer-Snedecor test

$F_{obs} = 0.53 < F_{1-\alpha} = 2.37$

The assumption of the non-validity of the linear dynamic range is rejected

5.3.1.5 ISO 8466-type approach

5.3.1.5.1 Basic protocol

It is advisable to use a number n of reference materials. The number must be higher than 3, but there is no need, however, to exceed 10. The reference materials should be measured several times, under **reproducibility conditions**. The number of measurements may be small at the center of the range studied (minimum = 2) and must be greater at both ends of the range, for which a minimum number of 4 is generally recommended. The accepted values of reference materials must be regularly distributed over the studied range of values.

NOTE It is vital that the reproducibility conditions use the maximum number of potential sources of variability.

The results are reported in a table presented as follows:

Reference materials	Accepted value of the reference material	Measured values				
		Replica 1	Replica 2	Replica j	...	Replica p
I	x_1	y_{11}	y_{12}	y_{1j}	...	y_{1p}
...
i	x_i	y_{i1}	y_{i2}			

**COMPENDIUM OF INTERNATIONAL ANALYSIS OF METHODS -
OIV**

Guide for the validation – quality control

...
N	x^n	y^{n1}	...	y^{nj}	...
					y^{np}

5.3.1.5.2 Calculations and results

5.3.1.5.2.1 Defining the linear regression model

Calculate the linear regression model using the calculations detailed above.

The residual error of the standard deviation for the linear model S_{res} can then be calculated using the formula indicated in § 5.3.1.4.2.4.1

5.3.1.5.2.2 Defining the polynomial regression model

The calculation of the polynomial model of order 2 is given below

The aim is to determine the parameters of the polynomial regression model of order 2 applicable to the data of the experiment schedule.

$$y = aX^2 + bX + c$$

The purpose is to determine the parameters a, b and c. This determination can generally be computerized using spreadsheets and statistics software.

The estimation formulae for these parameters are as follows:

$$a = \frac{\sum_i x_i^2 y_i \left(N \sum_i x_i^2 - \left[\sum_i x_i \right]^2 \right) - \sum_i x_i^3 \left(N \sum_i x_i y_i - \sum_i x_i \sum_i y_i \right) + \sum_i x_i^2 \left(\sum_i x_i y_i \right)}{\sum_i x_i^4 \left(N \sum_i x_i^2 - \left[\sum_i x_i \right]^2 \right) - \sum_i x_i^3 \left(N \sum_i x_i^3 - \sum_i x_i^2 \sum_i x_i \right) + \sum_i x_i^2 \left(\sum_i x_i \sum_i y_i \right)}$$

$$b = \frac{\sum_i x_i^4 \left(N \sum_i x_i y_i - \sum_i x_i \sum_i y_i \right) - \sum_i x_i^2 y_i \left(N \sum_i x_i^3 - \sum_i x_i^2 \sum_i x_i \right) + \sum_i x_i^2 \left(\sum_i y_i \sum_i x_i \right)}{\sum_i x_i^4 \left(N \sum_i x_i^2 - \left[\sum_i x_i \right]^2 \right) - \sum_i x_i^3 \left(N \sum_i x_i^3 - \sum_i x_i^2 \sum_i x_i \right) + \sum_i x_i^2 \left(\sum_i x_i \sum_i x_i \right)}$$

$$c = \frac{\sum_i x_i^4 \left(\sum_i x_i^2 \sum_i y_i - \sum_i x_i \sum_i x_i y_i \right) - \sum_i x_i^3 \left(\sum_i x_i^3 \sum_i y_i - \sum_i x_i^2 \sum_i x_i y_i \right) + \sum_i x_i^2 \left(\sum_i y_i \sum_i x_i \right)}{\sum_i x_i^4 \left(N \sum_i x_i^2 - \left[\sum_i x_i \right]^2 \right) - \sum_i x_i^3 \left(N \sum_i x_i^3 - \sum_i x_i^2 \sum_i x_i \right) + \sum_i x_i^2 \left(\sum_i x_i \sum_i x_i \right)}$$

Once the model has been established, the following values are to be calculated:

- regression value associated with the i^{th} reference material \hat{y}'_i

$$\hat{y}'_i = a x^2 + b x + c$$

- residual e_{ij} $e'_{ij} = y_{ij} - \hat{y}'_i$

Residual standard deviation of the polynomial model

$$S'_{res} = \sqrt{\frac{\sum_{i=1}^n \sum_{j=1}^p (y_{ij} - \hat{y}'_i)^2}{np - 2}}$$

5.3.1.5.2.3 Comparing residual standard deviations

Calculation of

$$DS^2 = (N - 2) S_{res}^2 - (N - 3) S'_{res}^2$$

Then

$$PG = \frac{DS^2}{S'^2_{res}}$$

The value PG is compared with the limit value $F_{1-\alpha}$ given by the Fischer-Snedecor table for a confidence level $1-\alpha$ and a degree of freedom 1 and (N-3).

NOTE In general the α risk used is 5%. In some cases the test may be optimistic and a risk of 10% will prove more realistic.

If $PG \leq F_{1-\alpha}$: the nonlinear calibration function does not result in an improved adjustment; for example, the calibration function is linear.

If $PG > F_{1-\alpha}$: the work scope must be as narrow as possible to obtain a linear calibration function: otherwise, the information values from the analyzed samples must be evaluated using a nonlinear calibration function.

Example: Theoretical case.

	Ti (ref)	Y1	Y2	Y3	Y4
<i>1</i>	<i>35</i>	<i>22.6</i>	<i>19.6</i>	<i>21.6</i>	<i>18.4</i>
<i>2</i>	<i>62</i>	<i>49.6</i>	<i>49.8</i>	<i>53</i>	
<i>3</i>	<i>90</i>	<i>105.2</i>	<i>103.5</i>		
<i>4</i>	<i>130</i>	<i>149</i>	<i>149.8</i>		
<i>5</i>	<i>205</i>	<i>203.1</i>	<i>202.5</i>	<i>197.3</i>	
<i>6</i>	<i>330</i>	<i>297.5</i>	<i>298.6</i>	<i>307.1</i>	<i>294.2</i>

Linear model and polynomial model, method: theoretical case

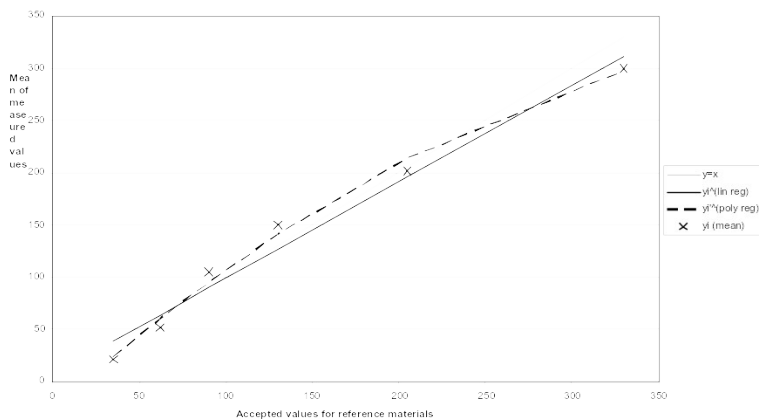

Linear regression

$$y = 1.48 \cdot x - 0.0015$$

$$S_{\text{res}} = 13.625$$

Polynomial regression

$$y = -0.0015x^2 + 1.485x - 27.2701$$

$$S'_{\text{res}} = 7.407$$

Fischer's test

$$PG = 10.534 > F(5\%) = 10.128$$

PG > F the linear calibration function cannot be retained

5.3.2 *Specificity*

5.3.2.1 *Normative definition*

The specificity of a method is its ability to measure only the compound being searched for.

5.3.2.2 *Application*

In case of doubt about the specificity of the tested method, the laboratory can use experiment schedules designed to check its specificity. Two types of complementary experiments are proposed here that can be used in a large number of cases encountered in the field of oenology.

**COMPENDIUM OF INTERNATIONAL ANALYSIS OF METHODS -
OIV
Guide for the validation – quality control**

- The first test is the standard addition test. It can be used to check that the method measures all the analyte.
- The second test can be used to check the influence of other compounds on the result of the measurement.

5.3.2.3 Procedures

5.3.2.3.1 Standard addition test

5.3.2.3.1.1 Scope

This test can be used to check that the method measures all the analyte. The experiment schedule is based on standard additions of the compound being searched for. It can only be applied to methods that are not sensitive to matrix effects.

5.3.2.3.1.2 Basic protocol

This consists in finding a significant degree of added quantities on test materials analyzed before and after the additions.

Carry out variable standard additions on *n* test materials. The initial concentration in analyte of test materials, and the standard additions are selected in order to cover the scope of the method. These test materials must consist of the types of matrices called for routine analysis. It is advised to use at least 10 test materials.

The results are reported in a table presented as follows:

Test material	Quantity before addition (<i>x</i>)	Quantity added (<i>v</i>)	Quantity after addition (<i>w</i>)	Quantity found (<i>r</i>)
1	x_1	v_1	w_1	$r_1 = w_1 - x_1$
...
<i>i</i>	x_i	v_i	w_i	$r_i = w_i - x_i$
...
<i>n</i>	X_n	V_n	w_n	$r_p = w_n - x_n$

NOTE 1 An addition is made with a pure standard solution. It is advised to perform an addition of the same order as the quantity of the test material on which it is carried out. This is why the most concentrated

test materials must be diluted to remain within the scope of the method.

NOTE 2 It is advised to prepare the additions using independent standard solutions, in order to avoid any systematic error.

NOTE 3 The quality of values x and w can be improved by using several repetitions.

5.3.2.3.1.3 *Calculations and results*

The principle of the measurement of specificity consists in studying the regression line $r = a + b.v$ and checking that slope b is equivalent to 1 and that intercept point a is equivalent to 0.

5.3.2.3.1.3.1 Study of the regression line $r = a + b.v$

The parameters of the regression line are obtained using the following formulae:

- mean of the added quantities \bar{v} $\bar{v} = \frac{\sum_{i=1}^n v_i}{n}$

- mean of the quantities found \bar{r} $\bar{r} = \frac{\sum_{i=1}^n r_i}{n}$

- estimated slope b $b = \frac{\sum_{i=1}^n (v_i - \bar{v})(r_i - \bar{r})}{\sum_{i=1}^n (v_i - \bar{v})^2}$

- estimated intercept point a $a = \bar{r} - b.\bar{v}$

- regression value associated with the i^{th} reference material \hat{y}_i
 $\hat{r}_i = a + b \times v_i$

- residual standard deviation

$$S_{res} = \sqrt{\frac{\sum_{i=1}^n (r_i - \hat{r}_i)^2}{n - 2}}$$

- standard deviation on the slope

$$S_b = S_{res} \sqrt{\frac{1}{\sum_{i=1}^n (v_i - \bar{v})^2}}$$

- standard deviation on the intercept point

$$S_a = S_{res} \sqrt{\frac{1}{n} + \frac{\bar{v}^2}{\sum_{i=1}^n (v_i - \bar{v})^2}}$$

5.3.2.3.1.3.2 Analysis of the results

The purpose is to conclude on the absence of any interference and on an acceptable specificity. This is true if the overlap line $r = a + bv$ is equivalent to the line $y = x$.

To do so, two tests are carried out:

- Test of the assumption that slope b of the overlap line is equal to 1.
- Test of the assumption that intercept point a is equal to 0.

These assumptions are tested using a Student test, generally associated with a risk of error of 1%. A risk of 5% can prove more realistic in some cases.

Let $T_{critical, bilateral}[\text{dof}; 1\%]$ be a Student bilateral variable associated with a risk of error of 1% for a number of degrees of freedom (dof).

Step 1: calculations

Calculation of the comparison criterion on the slope at 1

$$T_{obs} = \frac{|b-1|}{S_b}$$

COMPENDIUM OF INTERNATIONAL ANALYSIS OF METHODS - OIV

Guide for the validation – quality control

Calculation of the comparison criterion on the intercept point at 0

$$T_{obs} = \frac{|a|}{S_a}$$

Calculation of the Student critical value: $T_{critical, bilateral}[p-2; 1\%]$

Step 2: interpretation

- If T_{obs} is lower than $T_{critical}$, then the slope of the regression line is equivalent to 1
- If T'_{obs} is lower than $T_{critical}$, then the intercept point of the regression line is equivalent to 0.
- If both conditions are true, then the overlap line is equivalent = $y = x$, and the method is deemed to be specific.

NOTE 1 Based on these results, a mean overlap rate can be calculated to quantify the specificity. In no case should it be used to "correct" the results. This is because if a significant bias is detected, the alternative method cannot be validated in relation to an efficiency rate of 100%.

NOTE 2 Since the principle of the test consists in calculating a straight line, at least three levels of addition have to be taken, and their value must be correctly chosen in order to obtain an optimum distribution of the points.

5.3.2.3.1.3.3 Overlap line graphics

Example of specificity

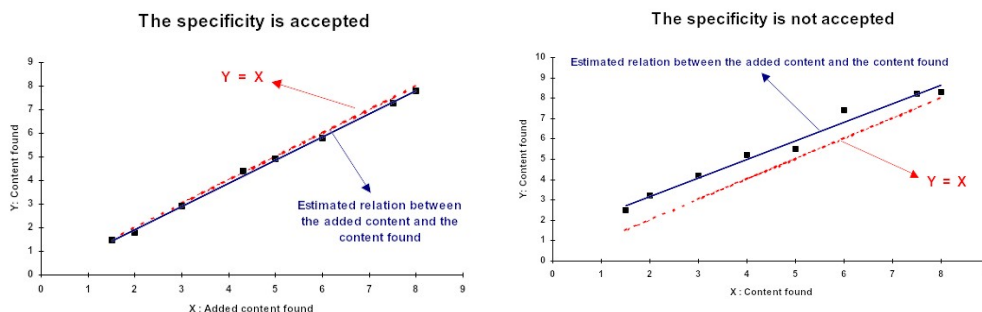

5.3.2.3.2 Study of the influence of other compounds on the measurement result

**COMPENDIUM OF INTERNATIONAL ANALYSIS OF METHODS -
OIV
Guide for the validation – quality control**

5.3.2.3.2.1 Scope

If the laboratory suspects the interaction of compounds other than the analyte, an experiment schedule can be set up to test the influence of various compounds. The experiment schedule proposed here enables a search for the influence of compounds defined *a priori*: thanks to its knowledge of the analytical process and its know-how, the laboratory should be able to define a certain number of compounds liable to be present in the wine and to influence the analytical result.

5.3.2.3.2.2 Basic protocol and calculations

Analyze *n* wines in duplicate, before and after the addition of the compound suspected of having an influence on the analytical result; *n* must at least be equal to 10.

The mean values *Mx_i* of the 2 measurements *x_i* and *x'_i* made before the addition shall be calculated first, then the mean values *My_i* of the 2 measurements *y_i* and *y'_i* made after the addition, and finally the difference *d_i* between the values *Mx_i* and *My_i*.

The results of the experiment can be reported as indicated in the following table:

Samples	x: Before addition		y: After addition		Means		Difference
	Rep1	Rep2	Rep1	Rep2	x	y	d
<i>l</i>	<i>x_l</i>	<i>x'_l</i>	<i>y_l</i>	<i>y'_l</i>	<i>Mx_l</i>	<i>My_l</i>	<i>d_l = Mx_l - My_l</i>
...
<i>i</i>	<i>x_i</i>	<i>x'_i</i>	<i>y_i</i>	<i>y'_i</i>	<i>Mx_i</i>	<i>My_i</i>	<i>d_i = Mx_i - My_i</i>
...
<i>n</i>	<i>x_n</i>	<i>x'_n</i>	<i>y_n</i>	<i>y'_n</i>	<i>Mx_n</i>	<i>My_n</i>	<i>d_n = Mx_n - My_n</i>

The mean of the results before addition *M_x*

$$M_x = \frac{1}{n} \sum_{i=1}^n Mx_i$$

The mean of the results after addition M_y

$$M_y = \frac{1}{n} \sum_{i=1}^n My_i$$

Calculate the mean of the differences M_d

$$M_d = \sum_{i=1}^n \frac{d_i}{n} = My - Mx$$

Calculate the standard deviation of the differences S_d

$$S_d = \sqrt{\frac{\sum_{i=1}^n (d_i - M_d)^2}{n - 1}}$$

Calculate the Z-score

$$Z_{score} = \frac{|M_d|}{S_d}$$

5.3.2.3.2.3 *Interpretation*

- If the Z_{score} is ≤ 2 , the added compound can be considered to have a negligible influence on the result of analysis with a risk of 5%.
- If the Z_{score} is ≥ 2 , the added compound can be considered to influence the result of analysis with a risk of 5%.

NOTE Interpreting the Z_{score} is possible given the assumption that the variations obey a normal law with a 95% confidence rate.

Example: Study of the interaction of compounds liable to be present in the samples, on the determination of fructose glucose in wines by Fourier transform infrared spectrophotometry (FTIR).

vin	Before addition		+ 250 mg.L ⁻¹ potassium sorbate		+ 1 g. L ⁻¹ salicylic acid		Differences	
	rep1	rep2	rep1	rep2	rep1	rep2	sorbate diff	salicylic diff
1	6.2	6.2	6.5	6.3	5.3	5.5	0.2	-0.8
2	1.2	1.2	1.3	1.2	0.5	0.6	0.05	-0.65

**COMPENDIUM OF INTERNATIONAL ANALYSIS OF METHODS -
OIV**

Guide for the validation – quality control

3	0.5	0.6	0.5	0.5	0.2	0.3	-0.05	-0.3
4	4.3	4.2	4.1	4.3	3.8	3.9	-0.05	-0.4
5	12.5	12.6	12.5	12.7	11.5	11.4	0.05	-1.1
6	5.3	5.3	5.4	5.3	4.2	4.3	0.05	-1.05
7	2.5	2.5	2.6	2.5	1.5	1.4	0.05	-1.05
8	1.2	1.3	1.2	1.1	0.5	0.4	-0.1	-0.8
9	0.8	0.8	0.9	0.8	0.2	0.3	0.05	-0.55
10	0.6	0.6	0.5	0.6	0.1	0	-0.05	-0.55

Potassium sorbate	$Md =$	0.02
	$Sd =$	0.086
	$Z_{score} =$	0.23 < 2

Salicylic acid	$Md =$	-0.725
	$Sd =$	0.282
	$Z_{score} =$	2.57 > 2

In conclusion, it can be stated that potassium sorbate does not influence the determination of fructose glucose by the FTIR gauging studied here. On the other hand, salicylic acid has an influence, and care should be taken to avoid samples containing salicylic acid, in order to remain within the scope of validity for the gauging under study.

5.3.3 Study of method accuracy

5.3.3.1 Presentation of the step

5.3.3.1.1 Definition

Correlation between the mean value obtained with a large series of test results and an accepted reference value.

5.3.3.1.2 General principles

When the reference value is output by a certified system, the accuracy study can be regarded a traceability link. This applies to two specific cases in particular:

COMPENDIUM OF INTERNATIONAL ANALYSIS OF METHODS - OIV

Guide for the validation – quality control

- Traceability to certified reference materials: in this case, the accuracy study can be undertaken jointly with the linearity and calibration study, using the experiment schedule described for that study.

- Traceability to a certified interlaboratory comparison analysis chain.

The other cases, i.e. which use references that are not based on certified systems, are the most widespread in routine oenological laboratories. These involve comparisons:

- Comparison with a reference method

- Comparison with the results of an uncertified interlaboratory comparison analysis chain.

- Comparison with internal reference materials, or with external uncertified reference materials.

5.3.3.1.3 Reference documents

- NF V03-110 Standard. intralaboratory validation procedure for an alternative method in relation to a reference method.
- NF V03-115 Standard, Guide for the use of reference materials.
- ISO 11095 Standard, linear calibration using reference materials.
- ISO 8466-1 Standard. Water quality – Calibration and evaluation of analytical methods and estimation of performance characteristics
- ISO 57025 Standard, Exactitude of results and methods of measurement

5.3.3.2 Comparison of the alternative method with the OIV reference method

5.3.3.2.1 Scope

This method can be applied if the laboratory uses the OIV reference method, or a traced, validated method, whose performance quality is known and meets the requirements of the laboratory's customers.

To study the comparative accuracy of the two methods, it is advisable first of all to ensure the quality of the repeatability of the method to be validated, and to compare it with the reference method. The method for carrying out the repeatability comparison is described in the chapter on repeatability.

5.3.3.2.2 Accuracy of the alternative method compared with the reference method

**COMPENDIUM OF INTERNATIONAL ANALYSIS OF METHODS -
OIV
Guide for the validation – quality control**

5.3.3.2.2.1 *Definition*

Accuracy is defined as the closeness of agreement between the values obtained by the reference method and that obtained by the alternative method, independent of the errors of precision of the two methods.

5.3.3.2.2.2 *Scope*

The accuracy of the alternative method in relation to the reference method is established for a field of application in which the repeatabilities of the two methods are constant.

In practice, it is therefore often advisable to divide the analyzable range of values into several sections or "range levels" (2 to 5), in which we may reasonably consider that the repeatabilities of the methods are comparable to a constant.

5.3.3.2.2.3 *Basic protocol and calculations*

In each range level, accuracy is based on a series of *n* test materials with concentration values in analyte covering the range level in question. A minimum number of 10 test materials is required to obtain significant results.

Each test material is to be analyzed in duplicate by the two methods under repeatable conditions.

A calculation is to be made of the mean values Mx_i of the 2 measurements x_i et x'_i made using the alternative method and the mean values My_i of the 2 measurements y_i et y'_i made using the reference method, then the difference d_i is to be calculated between the values Mx_i and My_i .

The results of the experiment can be reported as in the following table:

Test material	x: Alternative method		y: Reference method		Means		Difference
	Rep1	Rep2	Rep1	Rep2	x	y	d
<i>l</i>	x_l	x'_l	y_l	y'_l	Mx_l	My_l	$d_l = Mx_l - My_l$
...
<i>i</i>	x_i	x'_i	y_i	y'_i	Mx_i	My_i	$d_i = Mx_i - My_i$
...
<i>n</i>	x_n	x'_n	y_n	y'_n	Mx_n	My_n	$d_n = Mx_n - My_n$

The following calculations are to be made

- The mean of the results for the alternative method M_x

$$M_x = \frac{1}{n} \sum_{i=1}^n Mx_i$$

- The mean of the results for the reference method M_y

$$M_y = \frac{1}{n} \sum_{i=1}^n My_i$$

- Calculate the mean of the differences M_d

$$M_d = \sum_{i=1}^n \frac{d_i}{n} = Mx - My$$

- Calculate the standard deviation of the differences S_d

$$S_d = \sqrt{\frac{\sum_{i=1}^n (d_i - M_d)^2}{n - 1}}$$

- Calculate the Z_{score}

$$Z_{score} = \frac{|M_d|}{S_d}$$

5.3.3.2.2.4 Interpretation

- If the Z_{score} is **lower** than or equal to 2.0, it can be concluded that the accuracy of one method in relation to the other is satisfactory, in the range level under consideration, with a risk of error $\alpha = 5\%$.

- If the Z_{score} is **higher** than 2.0, it can be concluded that the alternative method is not accurate in relation to the reference method, in the range level under consideration, with a risk of error $\alpha = 5\%$.

NOTE Interpreting the Z_{score} is possible given the assumption that the variations obey a normal law with a 95% confidence rate.

Example: Study of the accuracy of FTIR gauging to determine glucose and fructose in relation to the enzymatic method. The first range level

**COMPENDIUM OF INTERNATIONAL ANALYSIS OF METHODS -
OIV**

Guide for the validation – quality control

covers the scale from 0 to 5 g.L⁻¹ and the second range level covers a scale from 5 to 20 g.L⁻¹.

Wine	FTIR 1	IRTF2	Enz 1	Enz 2	di
1	0	0.3	0.3	0.2	-0.1
2	0.2	0.3	0.1	0.1	0.2
3	0.6	0.9	0.0	0.0	0.7
4	0.7	1	0.8	0.7	0.1
5	1.2	1.6	1.1	1.3	0.2
6	1.3	1.4	1.3	1.3	0.0
7	2.1	2	1.9	2.1	0.0
8	2.4	0	1.1	1.2	0.1
9	2.8	2.5	2.0	2.6	0.3
10	3.5	4.2	3.7	3.8	0.1
11	4.4	4.1	4.1	4.4	0.0
12	4.8	5.4	5.5	5.0	-0.2

Md 0.13
Sd 0.23
Z_{score} 0.55 < 2

Wine	FTIR 1	IRTF2	Enz 1	Enz 2	di
1	5.1	5.4	5.1	5.1	0.1
2	5.3	5.7	5.3	6.0	-0.2
3	7.7	7.6	7.2	7.0	0.6
4	8.6	8.6	8.3	8.5	0.2
5	9.8	9.9	9.1	9.3	0.6
6	9.9	9.8	9.8	10.2	-0.1
7	11.5	11.9	13.3	13.0	-1.4
8	11.9	12.1	11.2	11.4	0.7
9	12.4	12.5	11.4	12.1	0.7
10	16	15.8	15.1	15.7	0.5
11	17.7	18.1	17.9	18.3	-0.2
12	20.5	20.1	20.0	19.1	0.7

Md = 0.19
Sd = 0.63
Z_{score} = 0.30 < 2

For the two range levels, the Z_{score} is lower than 2. The FTIR gauging for the determination of fructose glucose studied here, can be considered accurate in relation to the enzymatic method.

5.3.3.3 Comparison by interlaboratory tests

5.3.3.3.1 Scope

Interlaboratory tests are of two types:

1. **Collaborative studies** relate to a single method. These studies are carried out for the initial validation of a new method, mainly in order to define the standard deviation of interlaboratory reproducibility $SR_{\text{inter}}(\text{method})$. The mean m could also be given.

2. Interlaboratory comparison analysis chains, or **aptitude tests**. These tests are carried out for the validation of a method adopted by the laboratory, and the routine quality control (see § 5.3.3.3). The resulting value is the interlaboratory mean m , as well as the standard interlaboratory reproducibility and intermethod deviation SR_{inter} .

By participating in an analysis chain, or in a collaborative study, the laboratory can exploit the results in order to study the accuracy of a method, in order to ensure its validation first of all, and its routine quality control.

If the interlaboratory tests are carried out within the framework of a certified organization, this comparison work can be used for method traceability.

5.3.3.3.2 Basic protocol and calculations

To obtain a sufficient comparison, it is recommended to use a minimum number of 5 test materials over the period.

For each test material, two results are provided:

- The mean of all the laboratories with significant results m
- The standard deviation for interlaboratory reproducibility $S_{R-inter}$

The test materials are analyzed with p replicas by the laboratory, these replicas being carried out under repeatable conditions. p must at least be equal to 2.

In addition, the laboratory must be able to check that the intralaboratory variability (intralaboratory reproducibility) is lower than the interlaboratory variability (interlaboratory reproducibility) given by the analysis chain.

For each test material, the laboratory calculates the Z_{score} , given by the following formula:

$$Z_{score} = \frac{|m_{lab} - m|}{S_{R-inter}}$$

**COMPENDIUM OF INTERNATIONAL ANALYSIS OF METHODS -
OIV**

Guide for the validation – quality control

The results can be reported as indicated in the following table:

Test materia l	Rep1	...	Rep j	...	Rep p	Lab mean	Chain mean	Standard deviation	Z_{score}
1	x_{11}	...	x_{1j}	...	x_{1p}	$m_{lab1} = \sum_{j=1}^p$	m_1	$S_{R-inter(1)}$	$Z_{score1} = \frac{ m_1 - m }{S_1}$
...
i	x_{i1}	...	x_{ij}	...	x_{ip}	$m_{labi} = \sum_{j=1}^p$	m_i	$S_{R-inter(i)}$	$Z_{scorei} = \frac{ m_i - m }{S_i}$
...
n	x_{n1}	...	x_{nj}	...	x_{np}	$m_{labn} = \sum_{j=1}^p$	m_n	$S_{R-inter(n)}$	$Z_{scoren} = \frac{ m_n - m }{S_n}$

5.3.3.3 Interpretation

If all the Z_{score} results are lower than 2, the results of the method being studied can be considered identical to those obtained by the laboratories having produced significant results.

NOTE Interpreting the Z_{score} is possible given the assumption that the variations obey a normal law with a 95% confidence rate.

Example: An interlaboratory analysis chain outputs the following results for the free sulfur dioxide parameter, on two samples.

Samples	x_1	x_2	x_3	x_4	Lab mean	Chain mean	Standard deviation	Z_{score}
1	34	34	33	34	33.75	32	6	0.29 < 2
2	26	27	26	26	26.25	24	4	0.56 < 2

It can be concluded that on these two samples, the comparison with the analysis chain is satisfactory.

5.3.3.4 Comparison with reference materials

5.3.3.4.1 Scope

In situations where there is no reference method (or any other method) for a given parameter, and the parameter is not processed by the analysis chains, the only remaining possibility is comparison of the results of the method to be validated with accepted internal or external material reference values.

The reference materials, for example, could be synthetic solutions established with class-A glassware, and/or calibrated metrology apparatus.

In the case of certified reference materials, the comparison constitutes the traceability value, and can be carried out at the same time as the gauging and linearity study.

5.3.3.4.2 Basic protocol and calculations

It is advisable to have n reference materials for a given range level, in which it can be reasonably estimated that repeatability is comparable to a constant; n must at least be equal to 10.

Analyze in duplicate each reference material.

Calculate the mean values Mx_i for the 2 measurements x_i and x'_i carried out using the alternative method.

Define T_i the accepted value for the i^{th} reference material.

The results can be reported as indicated in the following table:

Reference material	x: Alternative method			T: Accepted value of the reference material	Difference d
	Rep1	Rep2	Mean x		
1	x_1	x'_1	Mx_1	T_1	$d_1 = Mx_1 - T_1$
...		
i	x_i	x'_i	Mx_i	T_i	$d_i = Mx_i - T_i$
...		
n	x_n	x'_n	Mx_n	T_n	$d_n = Mx_n - T_n$

The mean of the results of the alternative method M_x

$$M_x = \frac{1}{n} \sum_{i=1}^n Mx_i$$

The mean of the accepted values of reference materials M_T

$$M_T = \frac{1}{n} \sum_{i=1}^n T_i$$

Calculate the mean of the differences M_d

$$M_d = \sum_{i=1}^n \frac{d_i}{n} = M_x - M_T$$

Calculate the standard deviation of the differences S_d

$$S_d = \sqrt{\frac{\sum_{i=1}^n (d_i - M_d)^2}{n-1}}$$

Calculate the Z-score

$$Z_{score} = \frac{|M_d|}{S_d}$$

5.3.3.4.3 Interpretation

- If the Z_{score} is **lower than** or equal to 2.0, it can be concluded that the accuracy of the alternative method in relation to the accepted values for the reference material is good on the range level under consideration.

- If Z_{score} is **higher** than 2.0, it can be concluded that the alternative method is not accurate in relation to the accepted values for the reference materials in the range level under consideration.

NOTE Interpreting the Z_{score} is possible given the assumption that the variations obey a normal law with a 95% confidence rate.

**COMPENDIUM OF INTERNATIONAL ANALYSIS OF METHODS -
OIV
Guide for the validation – quality control**

Example: There is no reference method to compare the results of the analysis of Ethyl-4 Phenol (4-EP) by Gas chromatography coupled with mass spectrometry (GC-MS). The results are compared with the accepted values for reference materials, consisting of synthetic solutions formulated by traced equipment.

Test apparatus	Ti (ref)	Y1	Y2	Y3	Y4	My	d _i
1	4.62	6.2	6.56	4.9	5.7	5.8	1.2
2	12.3	15.1	10.94	12.3	11.6	12.5	0.2
3	24.6	24.5	18	25.7	27.8	24.0	-0.6
4	46.2	48.2	52.95	46.8	35	45.7	-0.5
5	77	80.72	81.36	83.2	74.5	79.9	2.9
6	92.4	97.6	89	94.5	99.5	95.2	2.8
7	123.2	126.6	129.9	119.6	126.9	125.8	2.6
8	246.4	254.1	250.9	243.9	240.4	247.3	0.9
9	385	375.8	366.9	380.4	386.9	377.5	-7.5
10	462	467.5	454.5	433.3	457.3	453.2	-8.9

$$Md = -0.7$$

$$Sd = . 4.16$$

$$Z_{score} = 0.16$$

Given these results, the values obtained by the analysis method for 4-EP by GC-MS can be considered accurate compared with the accepted values of reference materials.

5.4 Section three: random error study

5.4.1 General principle

Random error is approximated using precision studies. Precision is calculated used a methodology that can be applied under various experimental conditions, ranging between those of repeatability, and those of reproducibility, which constitute the extreme conditions of its measurement.

The precision study is one of the essential items in the study of the uncertainty of measurement.

5.4.2 *Reference documents*

- ISO 5725 Standard, Exactitude of results and methods of measurement
- NF V03-110 Standard, Intralaboratory validation procedure for an alternative method in relation to a reference method.

5.4.3 *Precision of the method*

5.4.3.1 *Definition*

Closeness of agreement between independent test results obtained under prescribed conditions.

NOTE 1 Precision depends only on the distribution of the random errors and has no relation with the true or specified value.

NOTE 2 Expressing the measurement of precision is based on the standard deviation of the test results.

NOTE 3 The term "independent test results" refers to results obtained such that they are not influenced by a previous result on the same or similar test material. Quantitative measurements of precision are critically dependent on the prescribed conditions. Repeatability and reproducibility conditions are particular sets of extreme conditions.

In practice, precision refers to all the experimental conditions ranging between the conditions of repeatability and those of reproducibility.

5.4.3.2 *Scope*

The protocols and calculations are detailed below, from the general theoretical case to the specific cases of repeatability and reproducibility. This exhaustive approach should make it possible to apply the precision study in most laboratory situations.

The precision study can be applied a priori without difficulty to every quantitative method.

In many cases, precision is not constant throughout the validity range for the method. In this case, it is advisable to define several sections or "range levels", in which we may reasonably consider that the precision is comparable to a constant. The calculation of precision is to be reiterated for each range level.

**COMPENDIUM OF INTERNATIONAL ANALYSIS OF METHODS -
OIV
Guide for the validation – quality control**

5.4.3.3 General theoretical case

5.4.3.3.1 Basic protocol and calculations

5.4.3.3.1.1 Calculations with several test materials

n test materials are analyzed over a relatively long period of time with several replicas, p_i being the number of replicas for the i^{th} test material. The properties of the test materials must maintain constant throughout the period in question. For each replica, the measurement can be made with K repetitions, (we do not take into account the case here where the number of repetitions K can vary from one test material to the other, which would complicate the calculations even more). The total number of replicas must be higher than 10, distributed over all the test materials.

The results can be reported as indicated in the following table, (case in which $K = 2$)

Replicas	1	...	j	p ₁	p _i	p _n						
<i>Test materials.</i>												
1	x_{11}	x'_{11}	x_{1j}	x'_{1j}	x_{1p_1}	x'_{1p_1}		
...												
i	x_{i1}	x'_{i1}	x_{ij}	x'_{ij}	x_{ip_i}	x'_{ip_i}		
...												
n	x_{n1}	x'_{n1}	x_{nj}	x'_{nj}	x_{np_n}	x'_{np_n}

In this situation, the standard deviation of total variability (or standard deviation of precision S_v) is given by the general expression:

$$S_v = \sqrt{\text{Var}(\bar{x}_{ij}) + (1 - \frac{1}{k})\text{Var}(\text{répet})}$$

where:

$\text{Var}(\bar{x}_{ij})$ variance of the mean of repeated replicas of all test materials.

$\text{Var}(\text{répet})$ variance of the repeatability of all the repetitions.

- If the test materials were analyzed in duplicate with each replica ($K = 2$), the expression becomes:

$$S_v = \sqrt{\text{Var}(\bar{x}_{ij}) + \frac{\text{Var}(\text{repeat})}{2}}$$

- When only one measurement of the test material has been carried out with each replica ($K = 1$), the variance of repeatability is null, the expression becomes:

$$S_v = \sqrt{\text{Var}(\bar{x}_{ij})}$$

- Calculation of $\text{Var}(\bar{x}_{ij})$

The mean of the two replicas x_{ij} and x'_{ij} is:

$$\bar{x}_{ij} = \frac{x_{ij} + x'_{ij}}{2}$$

For each test material, the mean of n replicas is calculated:

$$M_{x_i} = \frac{\sum_{j=1}^{p_i} \bar{x}_{ij}}{p_i}$$

The number of different measurements n is the sum of p_i

$$N = \sum_{i=1}^n p_i$$

The variance $\text{Var}(\bar{x}_{ij})$ is then given by the following equation

$$\text{Var}(x_{ij}) = \frac{\sum_{i=1}^n \sum_{j=1}^{p_i} (\bar{x}_{ij} - M_{x_i})^2}{N - n}$$

NOTE This variance can also be calculated using the variances of variability of each test material: $\text{Var}_i(x_j)$. The following relation is then used (it is strictly equivalent to the previous one):

$$Var(x_{ij}) = \frac{\sum_{i=1}^n (p_i - 1) \cdot Var_i(x_j)}{N - n}$$

- Calculation of $Var(repeat)$

The variance of repeatability is calculated as a conventional repeatability equation with n test materials in duplicate. According to the calculation of repeatability discussed in the section entitled "repeatability", for $K = 2$ the variance of repeatability is:

$$Var(repeat) = \frac{\sum_{i=1}^p \sum_{j=1}^{n_i} w_{ij}^2}{2N} \quad \text{where } w_{ij} = x_{ij} - x'_{ij}$$

Precision v is calculated according to the formula:

$$v = 2\sqrt{2} \cdot S_v = 2.8 \cdot S_v$$

The value of precision v means that in 95% of the cases, the difference between two values obtained by the method, under the conditions defined, will be lower than or equal to v .

NOTE 1 The use and interpretation of these results is based on the assumption that the variations obey a normal law with a 95% confidence rate.

NOTE 2 One can also define a precision of 99% with $v = 2.58\sqrt{2} \cdot S_v = 3.65 \cdot S_v$.

5.4.3.3.1.2 Calculations with 1 test material

In this situation, the calculations are simpler. It is advisable to carry out p measurement replicas of the test material, if necessary with a repetition of the measurement on each replica. p must at least be equal to 10.

In the following calculations, the measurement is considered to be carried out in duplicate with each replica.

- The variance $Var(\bar{x}_{ij})$ is then given by the following equation:

$$Var(x_{ij}) = \frac{\sum_{i=1}^p (\bar{x}_i - M_x)^2}{p-1}$$

where:

\bar{x}_i is the mean of the two repetitions of replica i
 p is the number of replicas
 M_x is the mean of all the replicas

- The variance $Var(repeat)$ is then given by the following equation:

$$Var(repeat) = \frac{\sum_{i=1}^p w_i^2}{2p}$$

where w_i : difference between the two repetitions of replica i

5.4.3.4 Repeatability

5.4.3.4.1 Definitions

Repeatability is the closeness of agreement between mutually-independent analysis results obtained with the method in question on the same wine, in the same laboratory, with the same operator using the same equipment, within a short period of time.

These experimental conditions will be called conditions of repeatability.

The value of repeatability r is the value below which the absolute difference between two results of the same analysis is considered to be located, obtained under the conditions of repeatability defined above, with a confidence level of 95%.

The repeatability standard deviation S_r is the standard deviation for the results obtained under the conditions of repeatability. It is a parameter of the dispersion of the results, obtained under conditions of repeatability.

5.4.3.4.2 Scope

A priori, the repeatability study can be applied without difficulty to every quantitative method, insofar as the repeatability conditions can be observed.

In many cases, repeatability is not constant throughout the range of validity of the method. It is therefore advisable to define several sections or "range levels", in which we may reasonably consider that the repeatability is comparable to a constant. The repeatability calculation is then to be reiterated for each range level.

5.4.3.4.3 Basic protocol and calculations

5.4.3.4.3.1 General case

The number of test materials may vary in relation to the NUMBER of replicas. In practice, we consider that the number of measurements of all test materials must be higher than 20. It is not necessary for the repeatability conditions to be maintained from one test material to another, but all the replicas carried out on the same test material must be carried out under these repeatability conditions.

Repeatability remains a special case of the precision calculation

$S_v = \sqrt{\text{Var}(\bar{x}_{ij}) + \frac{\text{Var}(\text{repeat})}{2}}$. The $\text{Var}(\text{repeat})$ part is naturally equal to 0 (only one measurement with each replica), and the calculation is the same as the calculation of $\text{Var}(x_{ij})$

$$S_r = \sqrt{\text{Var}(x_{ij})} = \sqrt{\frac{\sum_{i=1}^n \sum_{j=1}^{p_i} (\bar{x}_{ij} - M_{x_i})^2}{N - n}}$$

The value r means that in 95% of the cases, the difference between two values acquired under repeatable conditions will be lower than or equal to r .

5.4.3.4.3.2 Particular case applicable to only 1 repetition

In practice, the most current situation for automated systems is the analysis of test material with only one repetition. It is advisable to use at least 10 materials in order to reach the 20 measurements required. The two measurement replicas of the same test material must be carried out under repeatable conditions.

In this precise case, the calculation of S_r is simplified and becomes:

$$S_r = \sqrt{\frac{\sum_{i=1}^q w_i^2}{2p}}$$

in which:

S_r = the repeatability standard deviation

p = the number of test materials analyzed in duplicate

w_i = the absolute differences between duplicates

Repeatability r is calculated according to the formula:

$$r = 2.8 S_r$$

**COMPENDIUM OF INTERNATIONAL ANALYSIS OF METHODS -
OIV
Guide for the validation – quality control**

Example: For the alternative determination method of the free sulfur dioxide in question, and for a range of measurements from 0 to 50 mg/l, the operator will seek at least 10 samples with regularly distributed concentrations ranging between these values.

<i>Sample no.</i>	<i>x_i (in mg/l)</i>	<i>x'_i (in mg/l)</i>	<i>W_i (absolute value)</i>
1	14	14	0
2	25	24	1
3	10	10	0
4	2	3	1
5	35	35	0
6	19	19	0
7	23	23	0
8	27	27	0
9	44	45	1
10	30	30	0
11	8	8	0
12	48	46	2

Example: Using the values given in the table above, the following results are obtained:

$$Q = 12$$

$$S_r = 0.54 \text{ mg/l}$$

$$R = 1.5 \text{ mg/l}$$

This result can be used to state that, with a probability of 95%, the results obtained by the method under study will have a repeatability rate lower than 1.5 mg/l.

5.4.3.4.4 Comparison of repeatability

5.4.3.4.4.1 Determination of the repeatability of each method

To estimate the performance of a method, it can be useful to compare its repeatability with that of a reference method.

Let S_{r-alt} be the repeatability standard deviation of the alternative method, and S_{r-ref} the repeatability standard deviation of the reference method.

The comparison is direct. If the value of repeatability of the alternative method is lower than or equal to that of the reference method, the result is positive. If it is higher, the laboratory must ensure that the result rests compliant with the specification that it accepted for the method concerned. In the latter case, it may also apply a Fischer-Snedecor test to know if the value found for the alternative method is significantly higher than that of the reference method.

5.4.3.4.4.2 *Fischer-Snedecor test*

Calculate the ratio:

$$F_{obs} = \frac{S_{r-alt}^2}{S_{r-ref}^2}$$

Use the critical Snedecor value with a risk α equal to 0.05 corresponding to the Fischer variable with a confidence level $1 - \alpha$, in which $v1 = n(x)-n$, and $v2 = n(z)-m$ degrees of freedom: $F(N(x)-n, N(y)-m, 1 - \alpha)$. In the case of a calculated repeatability with only one repetition on p test materials for the alternative method, and q test materials for the reference method, the Fischer variable will have as a degree of freedom $v1 = p$, and $v2 = Q$, i.e.: $F(p, Q, 1 - \alpha)$.

Interpreting the test:

1/ $F_{obs} > F_{1-\alpha}$, the repeatability value of the alternative method is significantly higher than that of the reference method.

2/ $F_{obs} < F_{1-\alpha}$, we cannot state that the repeatability value of the alternative method is significantly higher than that of the reference method.

***Example:** The value of the repeatability standard deviation found for the determination method of free sulfur dioxide is:*

$$Sr = 0.54 \text{ mg/l}$$

The laboratory carried out the determination on the same test materials using the OIV reference method. The value of the repeatability standard deviation found in this case is:

$$S_{ref} = 0.39 \text{ mg/l}$$

$$F_{obs} = \frac{0.54^2}{0.39^2} = \frac{0,29}{0,15} = 1,93$$

$$v_2 = 12$$

$$v_1 = 12$$

$$F_{1-\alpha} = 2.69 > 1.93$$

The F_{obs} value obtained is lower than the value $F_{1-\alpha}$; we cannot state that the repeatability value of the alternative method is significantly higher than that of the reference method.

5.4.3.5 Intralaboratory reproducibility

5.4.3.5.1 Definition

Intralaboratory reproducibility is the closeness of agreement between the analysis results obtained with the method under consideration on the same wine, in the same laboratory, with the same operator or different operators using from the different gauging curves, on different days.

5.4.3.5.2 Scope

Reproducibility studies can be implemented on quantitative methods, if the time of analysis is reasonably limited, and if the capacity exists to keep at least one test material stable over time.

In many cases, reproducibility is not constant throughout the validity range of the method. In this case, it is advisable to define several sections or "range levels", in which it can be reasonably considered that reproducibility is comparable to a constant. The reproducibility calculation is then to be reiterated for each range level.

5.4.3.5.3 Basic protocol and calculations

The laboratory chooses one or more stable test materials. It applies the method regularly for a period equal to at least one month and keeps the results obtained (X_{ij} , material i , replica j). A minimum of 5 replicas is recommended for each test

**COMPENDIUM OF INTERNATIONAL ANALYSIS OF METHODS -
OIV**

Guide for the validation – quality control

material, the total minimum number of replicas being 10. The replicas can be analyzed in duplicate.

The calculation of precision fully applies to the calculation of reproducibility, integrating $Var(repeat)$ if the measurements are carried out in duplicate.

Reproducibility R is calculated according to the formula:

$$R = 2.8 S_R$$

The value R means that in 95% of the cases, the difference between two values acquired under reproducibility conditions will be lower than or equal to R .

Example: Reproducibility study of the determination of the sorbic acid in wines by steam distillation and reading by absorption at 256 Nm.

Two different sorbated wines were kept for a period of 3 months. The determination of the sorbic acid was carried out at regular intervals over this period, with repetition of each measurement.

Replicas	Test material 1		Test material 2	
	x1	x2	x1	x2
1	122	125	140	139
2	123	120	138	137
3	132	130	139	141
4	121	115	143	142
5	130	135	139	139
6	135	142	135	138
7	137	135	139	139
8	130	125	145	145
9	123	130	138	137
10	112	115	135	134
11	131	128	146	146
12			137	138
13			146	147
14			145	148
15			130	128

$$\begin{aligned}n &= 2 \\p_1 &= 11 \\p_2 &= 15 \\n &= 26\end{aligned}$$

$$\begin{aligned} \text{Var}(x_{ij}) &= 37.8 \\ \text{Var}(\text{repet}) &= 5.01 \\ S_R &= 6.35 \\ R &= 17.8 \end{aligned}$$

6. Quality control of analysis methods (IQC)

6.1 Reference documents

- Resolution OIV (Eno 19/2002: Harmonized recommendations for internal quality control in analysis laboratories.
- CITAC/EURACHEM: Guide for quality in analytical chemistry, 2002 Edition
- Standard NF V03-115, Guide for the use of reference materials

6.2 General principles

It is recalled that an analysis result can be affected two types of error: systematic error, which translates into bias, and random error. For series analyses, another type of error can be defined, which can be due to both systematic error and random error: this is the series effect, illustrated for example by the deviation of the measuring system during a series.

The IQC is designed to monitor and control these three errors.

6.3 Reference materials

The IQC is primarily based on exploiting the measurement results for reference materials. The choice and constitution of the materials are therefore essential steps that it must be controlled in order to provide an efficient basis for the system.

A reference material is defined by two parameters:

- Its matrix
- The assignment of its reference value

Several cases are possible; the cases encountered in oenology are summarized in the following two-dimensional table:

**COMPENDIUM OF INTERNATIONAL ANALYSIS OF METHODS -
OIV**

Guide for the validation – quality control

Matrix	Synthetic solution <i>Synthetic solutions can be used to constitute the matrix</i>	Natural matrix (wine etc.) <i>Natural matrices a priori constitute the most interesting</i>	Doped wine <i>A doped wine is a wine with an artificial addition of an analyte</i>
Value obtained by formula	The solution must be produced using metrological rules. It is recalled that the organization supplying the solution must provide guarantees about its quality and be certified if possible. The reference values will be	Not applicable	This method is applicable when the base wine is completely free of analyte. These types of materials are suitable for oenological additives that are not specific to the wine. If
External value to the laboratory	The organization supplying the solution must provide guarantees about its quality and be certified if possible. The reference values will be	The external value has been determined on the wine by an interlaboratory analysis chain. Certain organizations propose conditioned wine samples whose values have been determined in	In practice, this involves conditioned wine samples doped and/or chemically stabilized as proposed by organizations. These materials cannot claim to constitute a natural matrix. The reference values are
Value obtained by a reference method	If the synthetic solution has not been obtained with a calibrated material, the reference value can be determined by analyzing the	The measurement is carried out 3 times with the reference method, the selected value is the mean of the 3 results, insofar as they remain within an interval lower than the repeatability of the	The measurement is carried out 3 times with the reference method, the value retained is the mean of the 3 results, insofar as they remain within an interval lower than the repeatability of the method.
Value obtained by the method to be checked <i>The use of the</i>	The reference value is measured by the method to be checked. The material is measured over 10 repetitions, and a check will be made that the differences between these values are lower	The reference value is measured by the method to be checked. The material is measured over 10 repetitions, and a check is made that the differences between these values are lower than the repeatability value; the most extreme values can be withdrawn,	The reference value is measured using the method to be checked. The material is measured over 10 repetitions, and a check is made to ensure that the differences between these values are lower than the repeatability value; the most extreme values can be withdrawn, up to a

**COMPENDIUM OF INTERNATIONAL ANALYSIS OF METHODS -
OIV
Guide for the validation – quality control**

--	--	--	--	--

6.4 Checking the analytical series

6.4.1 *Definition*

An analytical series is a series of measurements carried out under repeatable conditions.

For a laboratory that mainly uses the analytical series method of analysis, a check must be made to ensure the instantaneous adjustment of the measuring instrument and its stability during the analytical series is correct.

Two complementary approaches are possible:

- the use of reference materials (often called by extension "control materials")
- the use of an internal standard, in particular for separative methods.

6.4.2 *Checking accuracy using reference materials*

Systematic error can be checked by introducing reference materials, the reference value of which has been assigned using means external to the method being checked.

The measured value of the reference material is associated with a tolerance limit, inside which the measured value is accepted as being valid. The laboratory defines tolerance values for each parameter and for each analytical system. **These values are specific to the laboratory.**

The control materials must be selected so that their reference values correspond to the levels of the values usually found for a given parameter. If the scale of measurement is broad, and the uncertainty of measurement is not constant on the scale, several control materials should be used to cover the various range levels.

6.4.3 *Intraseries precision*

When the analytical series are rather long, there is a risk of drift of the analytical system. In this case, intraseries precision must be checked using the same reference material positioned at regular intervals in the series. The same control materials as those used for accuracy can be used.

The variation in the measured values for same reference material during the series should be lower than the repeatability value r calculated for a confidence level of 95%.

NOTE For a confidence level of 99%, a value of $3.65.S_r$ can be used.

6.4.4 *Internal standard*

Certain separative methods enable the introduction of an internal standard into the product to be analyzed.

In this case, an internal standard should be introduced with calibrated material with a known uncertainty of measurement.

The internal standard enables a check to be made both of intraseries accuracy and precision. It should be noted that a drift affects the signals of the analyte and of the internal standard in equal proportions; since the value of the analyte is calculated with the value of the signal of the internal standard, the effect of the drift is cancelled.

The series will be validated if the internal standards are inside the defined tolerance values.

6.5 Checking the analysis system

6.5.1 *Definition*

This concerns an additional check to the series check. It differs from the latter in that it compiles values acquired over long time scales, and/or compares them with values resulting from other analysis systems.

Two applications will be developed:

- Shewhart charts to monitor the stability of the analysis system
- Internal and external comparison of the analysis system

6.5.2 *Shewhart chart*

Shewhart charts are graphic statistical tools used to monitor the drift of measurement systems, by the regular analysis, in practice under reproducibility conditions, of stable reference materials.

6.5.2.1 *Data acquisition*

A stable reference material is measured for a sufficiently long period, at defined regular intervals. These measurements are recorded and logged in control charts. The measurements are made under reproducibility conditions, and are in fact

exploitable for the calculation of reproducibility, and for the assessment of measurement uncertainty.

The values of the analytical parameters of the reference materials selected must be within valid measurement ranges.

The reference materials are analyzed during an analytical series, routine if possible, with a variable position in the series from one time to another. In practice, it is perfectly possible to use the measurements of control materials of the series to input the control charts.

6.5.2.2 Presentation of results and definition of limits

The individual results are compared with the accepted value of the reference material, and with the reproducibility standard deviation for the parameter in question, at the range level in question.

Two types of limits are defined in the Shewhart charts, the limits associated with individual results, and the limits associated with the mean.

The limits defined for the individual results are usually based on the standard deviation values for intralaboratory reproducibility for the range level in question. They are of two types:

- alert limit: $+/- 2.S_R$.
- action limit: $+/- 3.S_R$.

The limit defined for the cumulated mean narrows as the number of measurements increases.

- This limit is an action limit: $+/- \frac{3.S_R}{\sqrt{n}}$. **n** being the number of measurements indicated on the chart.

NOTE For reasons of legibility, the alert limit of the cumulated mean is only rarely reproduced on the control chart, and has as its value $+/- \frac{2.S_R}{\sqrt{n}}$.

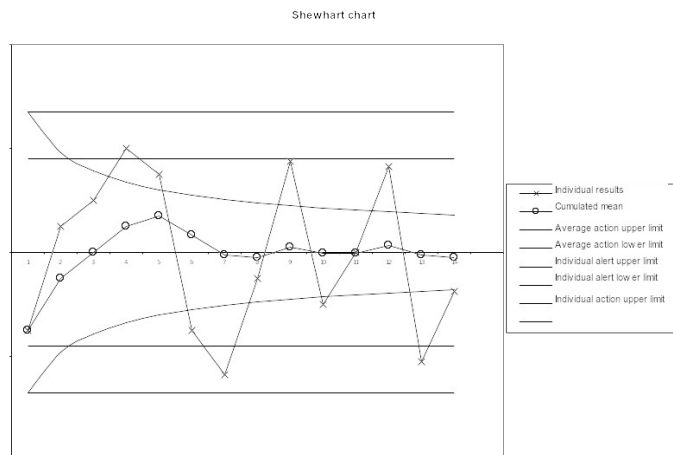

6.5.2.3 Using the Shewhart chart

Below we indicate the operating criteria most frequently used. It is up to the laboratories to precisely define the criteria they apply.

Corrective action on the method (or the apparatus) will be undertaken:

- a) if an individual result is outside the action limits of the individual results.
- b) if two consecutive individual results are located outside the alert limits of individual results.
- c) if, in addition, *a posteriori* analysis of the control charts indicates a drift in the method in three cases:
 - nine consecutive individual result points are located on the same side of the line of the reference values.
 - six successive individual result points ascend or descend.
 - two successive points out of three are located between the alert limit and the action limit.
- d) if the arithmetic mean of *n* recorded results is beyond one of the action limits of the cumulated mean (which highlights a systematic deviation of the results).

NOTE The control chart must be revised at *n* = 1 as soon as a corrective action has been carried out on the method.

6.5.3 Internal comparison of analysis systems

In a laboratory that has several analysis methods for a given parameter, it is interesting to carry out measurements of the same test materials in order to compare the results. The agreement of the results between the two methods is considered to be satisfactory if their variation remains lower than 2 times the standard deviation of difference calculated during validation, with a confidence level of 95%.

NOTE This interpretation is possible given the assumption that the variations obey a normal law with a 95% confidence rate.

6.5.4 External comparison of the analysis system

6.5.4.1 Analysis chain of interlaboratory comparisons

The organization of the tests and calculations is given in the chapter "comparison with an interlaboratory analysis chain".

In addition to checking the accuracy by the Z_{score} the results can be analyzed in greater detail, in particular with regard to the position of the values of the laboratory in relation to the mean. If they are systematically on the same side of the mean for several successive analysis chains, this can justify the implementation of corrective action by the laboratory, even if Z_{score} remains lower than the critical value.

NOTE Interpreting the Z_{score} is possible given the assumption that the variations obey a normal law with a 95% confidence rate.

If the intercomparison chain is subject to accreditation, this work of comparison has traceability value.

6.5.4.2 Comparison with external reference materials

Measuring external reference materials at regular intervals also can be used to supervise the occurrence of a systematic error (bias).

The principle is to measure the external reference material, and to accept or refuse the value in relation to tolerance limits. These limits are defined in relation to the

combination of the uncertainties of the controlled method and the reference value of the reference material.

6.5.4.2.1 Standard uncertainty of reference material

The reference values of these materials are accompanied by confidence intervals. The laboratory must determine the nature of this data, and deduce from them the standard uncertainty value for the reference value S_{ref} . A distinction must be made between several cases:

- The case in which uncertainty a is given in the form of an interval confidence at 95% (expanded uncertainty). This means that a normal law has been adopted. a therefore constitutes an "expanded uncertainty" and corresponds to 2 times the standard deviation S_{ref} of the standard uncertainty of the reference values of the materials provided.

$$S_{ref} = \frac{a}{2}$$

- The case of a certificate, or another specification, giving limits +/- a without specifying the confidence level. In this case, a rectangular dispersion has been adopted, and the value of measurement X has the same chance of having an unspecified value in the interval $ref \pm a$.
-

$$S_{ref} = \frac{a}{\sqrt{3}}$$

- The particular case of glassware giving limits +/- a . This is the framework of a triangular dispersion.
-

$$S_{ref} = \frac{a}{\sqrt{6}}$$

6.5.4.2.2 Defining the validity limits of measuring reference material

To standard uncertainty S_{ref} of the value of the external reference material, is added the standard uncertainty of the laboratory method to be checked, S_{method} . These two sources of variability must be taken into account in order to determine the limits.

S_{method} is calculated from the expanded uncertainty of the laboratory method in the following way:

$$S_{method} = \frac{uncertainty}{2}$$

The validity limit of the result (with a confidence level of 95%) =

$$reference\ value \pm 2 \cdot \sqrt{S_{ref}^2 + S_{method}^2}$$

Example: A pH 7 buffer solution is used to check a pH-meter. The confidence interval given by the pH solution is +/- 0.01. It is indicated that this confidence interval corresponds to the expanded uncertainty with a confidence level of 95%. In addition the expanded uncertainty of the pH-meter is 0.024.

The limits will be

$$\pm 2 \cdot \sqrt{\left(\frac{0.01}{2}\right)^2 + \left(\frac{0.024}{2}\right)^2}$$

i.e. +/- **0.026** in relation to the reference value, with a confidence level of 95%.

7. Assessment of measurement uncertainty

7.1 Definition

Parameter, associated with the result of a measurement, which characterizes the dispersion of the values that can reasonably be allotted to the measurand.

In practice, uncertainty is expressed in the form of a standard deviation called standard uncertainty $u(x)$, or in an expanded form (generally with $k = 2$) $U = \pm k \cdot u$

7.2 Reference documents

- AFNOR ENV 13005 Standard: 1999 – Guide for expressing measurement uncertainty
- EURACHEM, 2000. Quantifying Uncertainty in Analytical Measurement, *EURACHEM second edition 2000*
- ISO 5725 Standard: 1994 – Exactitude (accuracy and precision) of results and measurement methods
- ISO 21748 standard: 2004 – Guidelines relating to the use of estimations of repeatability, reproducibility and accuracy in evaluating measurement uncertainty
- Perruchet C and Priel M., Estimating uncertainty, *AFNOR Publications, 2000*

7.3 Scope

Uncertainty provides two types of information.

- On the one hand, that intended for the customers of the laboratory, indicating the potential variations to take into account in order to interpret the result of an analysis. It must be indicated, however, that this information cannot be used as an external means of evaluating the laboratory.
- In addition, it constitutes a dynamic in-house tool for evaluating the quality of the laboratory analysis results. Insofar as its evaluation is regular and based on a fixed, well-defined methodology, it can be used to see whether the variations involved in a method change positively or negatively (in the case of an estimate based exclusively on intralaboratory data).

The present guide limits itself to providing a practical methodology for oenological laboratories dealing with series analyses. These laboratories have large volumes of data of a significant statistical scale.

Estimating uncertainties can therefore be carried out in most cases using the data collected as part validation and quality control work (in particular with the data in the Shewhart charts). These data can be supplemented by experiment schedules, in particular to determine the systematic errors.

The reference systems describe two main approaches for determining uncertainty: the intralaboratory approach and the approach interlaboratory. Each provides results that are naturally and significantly different. Their significance and their interpretation cannot be identical.

- **the intralaboratory approach** provides a result specific to the method in question, in the laboratory in question. The uncertainty that results is an indicator of the performance of the laboratory for the method in question. It answers the customer as follows: "what dispersion of results can I expect from the laboratory practicing the method?"
- **the interlaboratory approach** uses results resulting from interlaboratory tests, which provide information about the overall performance of the method.

Laboratories can use the two approaches jointly. It will be interesting to see whether the results obtained using the intralaboratory approach give values lower than the values of the interlaboratory approach.

7.4 Methodology

The work of uncertainty assessment involves 3 fundamental steps.

- Definition of the measurand, and description of the quantitative analysis method
- Critical analysis of the measurement process
- Uncertainty assessment.

7.4.1 Definition of the measurand, and description of the quantitative analysis method

First of all, the following must be specified:

- the purpose of the measurement
- the quantity measured
- If the measurand is to be obtained by calculation based on measured quantities, if possible the mathematical relation between them should be stipulated.
- all the operating conditions.

These items are included in theory in the procedures of the laboratory quality system.

In certain cases the expression of the mathematical relation between the measurand and the quantities can be highly complex (physical methods etc.), and it is neither necessarily relevant nor possible to fully detail them.

7.4.2 Critical analysis of the measurement process

The sources of error influencing the final result should be identified in order to constitute the uncertainty budget. The importance of each source can be estimated, in order to eliminate those that have only a negligible minor influence. This is done by estimating:

- the degree of gravity of the drift generated by poor control of the factor in question
- the frequency of the potential problems
- their detectability.

This critical analysis can, for example, be carried out using the "5M" method.

Labor:

Operator effect

Matter:

Sample effect (stability, homogeneity, matrix effects), and consumables (reagents, products, solutions, reference materials), etc.

Hardware:

Equipment effect (response, sensitivity, integration modes, etc.), and laboratory equipment (balance, glassware etc.).

Method:

Application effect of the procedure (operating conditions, succession of the operations etc.).

Medium:

Environmental conditions (temperature, pressure, lighting, vibration, radiation, moisture etc.).

7.4.3 Estimation calculations of standard uncertainty (intralaboratory approach)

7.4.3.1 Principle

In the case of laboratories using large series of samples with a limited number of methods, a statistical approach based on intralaboratory reproducibility, supplemented by the calculation of sources of errors not taken into account under

intralaboratory reproducibility conditions, appears to be the most suitable approach.

An analysis result deviated from the true value under the effect of two sources of error: systematic errors and random errors.

$$\text{Analysis result} = \text{True value} + \text{Systematic error} + \text{Random error}$$

Uncertainty characterizes the dispersion of the analysis result. This translates into a standard deviation.

Variability (analysis result) = uncertainty

Variability (true value) = 0

$$\text{Variability (systematic error)} = \sqrt{\sum S_{\text{erreurs systématiques}}^2}$$

Variability (random error) = S_R (intralaboratory reproducibility standard deviation)

Since standard deviations are squared when added, the estimated standard uncertainty $u(x)$ takes the following form:

$$u(x) = \sqrt{\sum u_{(\text{systematic errors})}^2 + S_R^2}$$

Non-integrable sources of errors under the intralaboratory reproducibility conditions, i.e. systematic errors, must be determined in the form of standard deviation to be combined together and with the reproducibility standard deviation.

The laboratory can take action so that the reproducibility conditions applied make it possible to include a maximum number of sources of errors. This is obtained in particular by constituting stable test materials over a sufficiently long period, during which the laboratory takes care to vary all the possible experimental factors. In this way, S_R will cover the greatest number of possible sources of errors (random), and the work involved in estimating the systematic errors, which is often more complex to realize, will be minimized.

It should be noted here that the EURACHEM/CITAC guide entitled "Quantifying uncertainty in analytical measurements" recalls that "In general, the ISO Guide requires that corrections be applied for all systematic effects that are identified and significant". In a method "under control", systematic errors should therefore constitute a minor part of uncertainty.

**COMPENDIUM OF INTERNATIONAL ANALYSIS OF METHODS -
OIV**

Guide for the validation – quality control

The following non-exhaustive table gives examples of typical sources of error and proposes an estimation approach for each of them, using integration under reproducibility conditions as much as possible.

<i>Source of error</i>	<i>Type of error</i>	<i>Commentary</i>	<i>Estimation method</i>
Sampling (constitution of the sample)	Random	Sampling is one of the "businesses" defined in the ISO 17025 standard. Laboratories stating they do not perform sampling, do not include this source of error in the uncertainty assessment.	Can be including in intralaboratory reproducibility by including sampling in handling.
Sub-sampling (sampling a quantity of sample in order to carry out the test)	Random	Is significant if the sample is not homogeneous. This source of error remains minor for wine.	Included in the intralaboratory reproducibility conditions if the test material used is similar to routine test materials.
Stability of the sample	Random	Depends on the storage conditions of the sample. In the case of wines, laboratories should pay detailed attention to the losses of sulfur dioxide and ethanol.	Possible changes in the sample can be integrated into the reproducibility conditions. This source of uncertainty can then be evaluated overall.
Gauging of the apparatus	Systematic/ Random This error is systematic if gauging is established for a long period, and becomes random if gauging is regularly carried out over a time-scale integrated under reproducibility conditions	Source of error to be taken into account in absolute methods.	Error of gauging line § 7.4.2.4.1 Taken into account under the reproducibility conditions if gauging is regularly revised.
Effect of contamination or memory	Random	This effect will be minimized by the proper design of measuring instruments and suitable rinsing operations	The reproducibility conditions take this effect into account, as long as the reference materials are inserted at various positions in the analysis series.
Precision of automata	Random	This applies to intraseries drift in particular. This can be controlled in particular by positioning the control materials within the	The reproducibility conditions take this effect into account, as long as the reference materials are inserted at various positions

**COMPENDIUM OF INTERNATIONAL ANALYSIS OF METHODS -
OIV
Guide for the validation – quality control**

		framework of the IQC	in the analysis series.
Purity of the reagents	Random	The purity of the reagents has very little effect on the relative methods, insofar as the gauging and analyses are carried out with the same batches of reagents. This effect is to be taken into account in absolute methods.	To be integrated under reproducibility conditions using various batches of reagents.
Measurement conditions	Random	Effects of temperature, moisture etc.	Typically taken into account under reproducibility conditions
Matrix effect	Random from one sample to another, systematic on the same sample	These effects are to be taken into account in methods whose measured signal is not perfectly specific.	If this effect is regarded as significant, a specific experiment schedule can be used to estimate uncertainty due to this effect § 7.4.2.4.3 This effect is not integrated under reproducibility conditions.
Gauging effect	Systematic if gauging is constant Random if gauging is regularly renewed		Taken into account under the reproducibility conditions if gauging is regularly renewed. If the gauging used remains the same one (on the scale of the periods in question within the framework of the reproducibility conditions), it is advisable to implement an experiment schedule in order to estimate the error of the gauging line § 7.4.2.4.1
Operator effect	Random		To be taken into account in the reproducibility conditions by taking care to utilize all the authorized operators.
Bias	Systematic	Must be minimized by the quality control work of the laboratory.	Systematic effect, can be estimated using certified references.

7.4.3.2 Calculating the standard deviation of intralaboratory reproducibility

The reproducibility standard deviation S_R is calculated using the protocol described in the section entitled "Intralaboratory reproducibility" (cf. § 5.4.3.5).

The calculation can be based on several test materials. In the noteworthy case where S_R is proportional to the size of the measurand, the data collected on several test materials with different values should not be combined: S_R should be expressed in relative value (%).

**COMPENDIUM OF INTERNATIONAL ANALYSIS OF METHODS -
OIV
Guide for the validation – quality control**

7.4.3.3 Estimating typical sources of systematic errors not taken into account under reproducibility conditions

7.4.3.3.1 Gauging error (or calibration error)

Whenever the gauging of an instrument (or the calibration of an absolute method) is not regularly redone, its output cannot be integrated in the reproducibility values. An experiment schedule must be carried out in order to estimate it using the residual error of the regression.

7.4.3.3.1.1 Procedure

The approach is similar to that carried out in the linearity study of the method.

It is recommended to implement a number *n* of reference materials. The number must be higher than 3, but it is not necessary to go beyond 10. The reference materials are to be measured *p* times under intralaboratory precision conditions, *p* must be higher than 3, a figure of 5 is generally recommended. The accepted values of reference materials must be regularly distributed on the range of values under study. The number of measurements must be the same for all the reference materials.

The results are reported in a table presented as follows:

Reference materials	Accepted value of the reference material	Measured values				
		Replica 1	...	Replica j	...	Replica p
<i>1</i>	x_1	y_{11}	...	y_{1j}	...	y_{1p}
...
<i>i</i>	x_i	y_{i1}	...	y_{ij}	...	y_{ip}
...
<i>n</i>	x^n	y^{n1}	...	y^{nj}	...	y^{np}

7.4.3.3.1.2 Calculations and results

The linear regression model is calculated.

$$y_{ij} = a + b \cdot x_i + \varepsilon_{ij}$$

where

- y_{ij} is j^{th} replica of the i^{th} reference material.
- x_i is the accepted value of the i^{th} reference material.
- b is the slope of the regression line.
- a is the intercept point of the regression line.
- $a + b \cdot x_i$ represent the expectation of the measurement value of the i^{th} reference material.

ε_{ij} is the difference between y_{ij} and the expectation of the measurement value of the i^{th} reference material.

The parameters of the regression line are obtained using the following formulae:

- mean of p measurements of the i^{th} reference material

$$y_i = \frac{1}{p} \sum_{j=1}^p y_{ij}$$

- mean of all the accepted values of n reference materials

$$M_x = \frac{1}{n} \sum_{i=1}^n x_i$$

- mean of all measurements

$$M_y = \frac{1}{n} \sum_{i=1}^n y_i$$

- estimated slope b

$$b = \frac{\sum_{i=1}^n (x_i - M_x)(y_i - M_y)}{\sum_{i=1}^n (x_i - M_x)^2}$$

- estimated intercept point a $a = M_y - b \times M_x$

- regression value associated with the i^{th} reference material \hat{y}_i

$$\hat{y}_i = a + b \times x_i$$

- residual e_{ij} $e_{ij} = y_{ij} - \hat{y}_i$

7.4.3.3.1.3 Estimating the standard uncertainty associated the gauging line (or calibration line)

If the errors due to the regression line are constant over the entire field, the standard uncertainty is estimated in a global, single way by the overall residual standard deviation.

$$u_{(gauging)} = S_{res} = \sqrt{\frac{\sum_{i=1}^n \sum_{j=1}^p (y_{ij} - \hat{y}_i)^2}{np - 2}}$$

If the errors due to the regression line are not constant over the entire field, the standard uncertainty is estimated for a given level by the residual standard deviation for this level.

$$u_{(gauging),i} = S_{res,i} = \sqrt{\frac{\sum_{j=1}^p (y_{ij} - \hat{y}_i)^2}{p - 1}}$$

NOTE These estimates of standard deviations can be used if the linear regression model and the gauging (or calibration) domain have been validated (see § 5.3.1)

7.4.3.3.2 Bias error

According to the EURACHEM guide, "*Quantifying uncertainty in analytical measurements*", it is recalled that the ISO guide generally requires that corrections be applied for all identified significant systematic effects. The same applies to the

bias of methods for which the laboratory implements its quality control system (see §6), and which tends towards 0 for methods "under control".

In practice, a distinction can be made between two cases:

7.4.3.3.2.1 Methods adjusted with only one certified reference material

Bias is permanently adjusted with the same reference material.

The certified reference material (CRM) ensures the metrological traceability of the method. A reference value was allotted to the CRM together with its standard uncertainty u_{ref} . This standard uncertainty of the CRM is combined with the compound uncertainty for the method, u_{comp} , to determine the overall standard uncertainty of the laboratory method $u(x)$.

The overall standard uncertainty of the method adjusted with the CRM in question is therefore:

$$u(x) = \sqrt{u_{ref}^2 + u_{comp}^2}$$

NOTE 1 The methodology is identical in the case of methods adjusted with the results of an interlaboratory comparison chain.

NOTE 2 Note the difference between a CRM used to adjust the bias of a method, in which the uncertainty of its reference value combines with that of the method, and a CRM used to control a method adjusted by other means (cf. § 6.5.4.2). In the second case, the uncertainty of the CRM should not be used for the uncertainty assessment of the method.

7.4.3.3.2.2 Methods adjusted with several reference materials (gauging ranges etc.)

There is no particular adjustment of bias apart from gauging work.

It is clear that each calibrator introduces bias uncertainty. There is therefore an overall theoretical uncertainty of bias, which is a combination of the uncertainties of each calibrator. This uncertainty is very delicate to estimate, but it generally proves to be sufficiently low to be ignored, in particular if the laboratory monitors the quality of its calibrators, and the uncertainty of their reference values.

Other than in specific cases, bias uncertainty is ignored here.

7.4.3.3.3 Matrix effect

7.4.3.3.3.1 Definition

The matrix effect incurs a repeatable source of error for a given sample, but random from one sample to another. This error is related to the interaction of the compounds present in the product to be analyzed on measuring the required analyte. The matrix effect appears in methods with a nonspecific signal.

The matrix effect often constitutes a small part of uncertainty, particularly in separative methods. In certain other methods, including the infra-red techniques, it is a significant component of uncertainty.

Example: Estimate of the matrix effect on FTIR

The signal for the FTIR, or infra-red spectrum, is not a signal specific to each of the compounds that are measured by this technique. The statistical gauging model can be used to process disturbed, nonspecific spectral data in a sufficiently exact estimate of the value of the measurand. This model integrates the influences of the other compounds of the wine, which vary from one wine to the next and introduce an error into the result. Upstream of the routine analysis work, special work is carried out by the gauging developers to minimize this matrix effect and to make gauging robust, i.e. capable of integrating these variations without reflecting them in the result. Nevertheless the matrix effect is always present and constitutes a source of error at the origin of a significant part of the uncertainty of an FTIR method.

To be completely rigorous, this matrix effect error can be estimated by comparing, on the one hand, the means for a great number of FTIR measurement replicas, obtained on several reference materials (at least 10), under reproducibility conditions, and the true values of reference materials with a natural wine matrix on the other. The standard deviation of the differences gives this variability of gauging (provided that the gauging has been adjusted beforehand (bias = 0)).

This theoretical approach cannot be applied in practice, because the true values are never known, but it is experimentally possible to come sufficiently close to it:

- As a preliminary, the FTIR gauging must be statistically adjusted (bias = 0) in relation to a reference method based on at least 30 samples. This can be used to eliminate the effects of bias in the measurements thereafter.
- The reference materials must be natural wines. It is advisable to use at least 10 different reference materials, with values located inside a range level, the uncertainty of which can be considered to be constant.
- An acceptable reference value is acquired, based on the mean of several measurements by the reference method, carried out under reproducibility conditions. This can be used to lower the uncertainty of the reference value: if, for the reference method used, all the significant sources of uncertainty range within reproducibility conditions, the multiplication of the number p of measurements carried out under reproducibility conditions, enable the uncertainty associated with their mean to be divided by \sqrt{p} . The mean obtained using a sufficient number of measurements will then have a low level of uncertainty, even negligible in relation to the uncertainty of the alternative method; and can therefore be used as a reference value. p must at least be equal to 5.
- The reference materials are analyzed by the FTIR method, with several replicas, acquired under reproducibility conditions. By multiplying the number of measurements q under reproducibility conditions on the FTIR method, the variability related to the precision of the method (random error) can be decreased. The mean value of these measurements will have a standard deviation of variability divided by \sqrt{q} . This random error can then become negligible in relation to the variability linked to the gauging (matrix effect) that we are trying to estimate. q must at least be equal to 5.

The following example is applied to the determination of acetic acid by FTIR gauging. The reference values are given by 5 measurements under reproducibility conditions on 7 stable test materials. The number of 7 materials is in theory insufficient, but the data here are only given by way of an example.

**COMPENDIUM OF INTERNATIONAL ANALYSIS OF METHODS -
OIV
Guide for the validation – quality control**

Materials	Reference method					Mean n Ref	FTIR					Mean FTIR	Diff
	1	2	3	4	5		1	2	3	4	5		
1	0.3	0.3	0.3	0.3	0.3	0.30	0	0.3	0.3	0.3	0.3	0.305	-0.004
2	0.3	0.3	0.3	0.3	0.3	0.31	0	0.3	0.3	0.3	0.3	0.315	-0.006
3	0.3	0.3	0.3	0.3	0.3	0.38	0	0.3	0.3	0.3	0.3	0.37	-0.016
4	0.2	0.2	0.2	0.2	0.2	0.24	0	0.2	0.2	0.2	0.2	0.26	0.01
5	0.3	0.3	0.4	0.4	0.3	0.39	0	0.4	0.4	0.4	0.4	0.425	0.03
6	0.2	0.2	0.2	0.2	0.2	0.26	0	0.2	0.2	0.2	0.2	0.255	-0.008
7	0.3	0.3	0.3	0.3	0.3	0.36	0	0.3	0.3	0.3	0.3	0.365	-0.008

Calculation of the differences: $diff = Mean\ FTIR - Mean\ ref.$

The mean of the differences $M_d = 0.000$ verifies (good adjustment of the FTIR compared with the reference method)

The standard deviation of the differences, $S_d = 0.015$. It is this standard deviation that is used to estimate the variability generated by the gauging, and we can therefore state that:

$$U_f = 0.015$$

NOTE It should be noted that the value of U_f can be over-estimated by this approach. If the laboratory considers that the value is significantly excessive under the operating conditions defined here, it can increase the number of measurements on the reference method and/or the FTIR method.

The reproducibility conditions include all the other significant sources of error, S_R was otherwise calculated: $SR = 0.017$

The uncertainty of the determination of acetic acid by this FTIR application is:

$$+/- 2 * \sqrt{0.015^2 + 0.017^2} \text{ or } +/- 0.045 \\ \text{g.L}^{-1}$$

7.4.3.3.4 Sample effect

In certain cases, the experiment schedules used to estimate uncertainty are based on synthetic test materials. In such a situation, the estimate does not cover the sample effect (homogeneity). The laboratories must therefore estimate this effect.

It should be noted, however, that this effect is often negligible in oenological laboratories, which use homogeneous samples of small quantities.

7.4.4 Estimating standard uncertainty by interlaboratory tests

7.4.4.1 Principle

The interlaboratory approach uses data output by interlaboratory tests from which a standard deviation of interlaboratory reproducibility is calculated, in accordance with the principles indicated in §5.4.3. The statisticians responsible for calculating the results of the interlaboratory tests can identify "aberrant" laboratory results, by using tests described in the ISO 5725 standard (Cochran test). These results can then be eliminated after agreement between the statisticians and the analysts.

For the uncertainty assessment by interlaboratory approach, the guidelines stated in the ISO 21748 standard are as follows:

1. The reproducibility standard deviation (interlaboratory) obtained in a collaborative study is a valid basis for evaluating the uncertainty of measurement
2. Effects that are not observed as part of the collaborative study must be obviously negligible or be explicitly taken into account.

There are two types of interlaboratory tests:

1. Collaborative studies which relate to only one method. These studies are carried out for the initial validation of a new method in order to define the standard deviation of interlaboratory reproducibility ***SR_{inter}*** (*method*).

2. Interlaboratory comparison chains, or aptitude tests. These tests are carried out to validate a method adopted by the laboratory, and the routine quality control (see § 5.3.3.3). The data are processed as a whole, and integrate all the analysis methods employed by the laboratories participating in the tests. The results are the interlaboratory mean m , and the standard deviation of interlaboratory and intermethod reproducibility SR_{inter} .

7.4.4.2 Using the standard deviation of interlaboratory and intramethod reproducibility SR_{inter} (method)

The standard deviation of intralaboratory reproducibility SR_{inter} (**method**) takes into account intralaboratory variability and the overall interlaboratory variability related to the method.

Then must be taken into account the fact that the analysis method can produce a systematic bias compared with the true value.

As part of a collaborative study, whenever possible, the error produced by this bias can be estimated by using certified reference materials, under the same conditions as described in § 7.4.3.3.2, and added to SR_{inter} (**method**).

7.4.4.3 Using the standard deviation of interlaboratory and intermethod reproducibility SR_{inter}

The standard deviation of intralaboratory reproducibility SR_{inter} takes into account intralaboratory variability and interlaboratory variability for the parameter under study.

The laboratory must check its accuracy in relation to these results (see § 5.3.3).

There is no need to add components associated with method accuracy to the uncertainty budget, since in the "multi-method" aptitude tests, errors of accuracy can be considered to be taken into account in SR_{inter} .

7.4.4.4 Other components in the uncertainty budget

Insofar as the test materials used for the interlaboratory tests are representative of the conventional samples analyzed by laboratories, and that they follow the overall analytical procedure (sub-sampling, extraction, concentration, dilution, distillation etc.), SR_{inter} represents the standard uncertainty $u(x)$ of the method, in the interlaboratory sense.

Errors not taken into account in the interlaboratory tests must then be studied in order to assess their compound standard uncertainty, which will be combined with the compound standard uncertainty of the interlaboratory tests.

7.5 Expressing expanded uncertainty

In practice, uncertainty is expressed in its expanded form, in absolute terms for methods in which uncertainty is stable in the scope in question, or relative when uncertainty varies proportionally in relation to the quantity of the measurand:

Absolute uncertainty: $U = +/- 2.u(x)$

Relative uncertainty (in %): $U = +/- \frac{2.u(x)}{\bar{x}} .100$

where \bar{x} mean represents the reproducibility results.

NOTE This expression of uncertainty is possible given the assumption that the variations obey a normal law with a 95% confidence rate.

These expressions result in a given uncertainty value with a confidence level of **95%**.

REFERENCES

- (1) **OIV, 2001** – Recueil des methods internationales d’analyse des vins and des moûts; *OIV Ed., Paris.*
- (2) **OIV, 2002** – Recommandations harmonisées pour le contrôle interne de qualité dans les laboratoires d’analyse; *OIV resolution œno 19/2002., Paris.*
- (3) **Standard ISO 5725: 1994** – Exactitude (justesse and fidélité) des results and methods de mesure, *classification index X 06-041-1*
- (4) **IUPAC, 2002** – Harmonized guidelines for single-laboratory validation of analysis methods; *Pure Appl. Chem., Vol. 74; n°5, pp. 835-855.*
- (5) **Standard ISO 11095: 1996** – Etalonnage linéaire utilisant des materials de référence, *reference number ISO 11095:1996*
- (6) **Standard ISO 21748: 2004** – Lignes directrices relatives à l’utilisation d’estimation de la répétabilité, de la reproductibilité and de la justesse dans l’évaluation de l’incertitude de mesure, *reference number ISO ISO/TS 21748:2004*
- (7) **Standard AFNOR V03-110: 1998** – Procédure de validation intralaboratory d’une method alternative par rapport à une method de référence, *classification index V03-110*
- (8) **Standard AFNOR V03-115: 1996** – Guide pour l’utilisation des materials de référence, *classification index V03-115*
- (9) **Standard AFNOR X 07-001: 1994** – Vocabulaire international des termes fondamentaux and généraux de métrologie, *classification index X07-001*
- (10) **Standard AFNOR ENV 13005: 1999** – Guide pour l’expression de l’incertitude de mesure
- (11) **AFNOR, 2003**, - Métrologie dans l’entreprise, outil de la qualité 2^{ème} édition, *AFNOR 2003 edition*
- (12) **EURACHEM, 2000**. - Quantifying Uncertainty in Analytical Measurement, *EURACHEM second edition 2000*
- (13) **CITAC / EURACHEM, 2000** - Guide pour la qualité en chimie analytique, *EURACHEM 2002 edition*

(14) Bouvier J.C., 2002 - Calcul de l'incertitude de mesure – Guide pratique pour les laboratoires d'analyse œnologique, *Revue Française d'œnologie no.197*, Nov-Dec 2002, pp: 16-21

(15) Snakkers G. and Cantagrel R., 2004 - Utilisation des données des circuits de comparaison interlaboratoires pour apprécier l'exactitude des results d'un laboratoire Estimation d'une incertitude de mesure - *Bull OIV, Vol. 77* 857-876, Jan – Feb 2004, pp: 48-83

(16) Perruchet C. and Priel M, 2000 - Estimer l'incertitude, *AFNOR Editions*

(17) Neuilly (M.) and CETAMA, 1993 - Modélisation and estimation des errors de mesures, *Lavoisier Ed, Paris*

**COMPENDIUM OF INTERNATIONAL ANALYSIS OF METHODS -
OIV
Guide for the validation – quality control**

Annex N°1

Table A - Law of SNEDECOR

This table indicates values of **F** in function with **v₁** and **v₂** for a risk **α** of 0,05

P=0,950

v₁ v₂	1	2	3	4	5	6	7	8	9	10	v₁ v₂
1	161,4	199,5	215,7	224,6	230,2	234,0	236,8	238,9	240,5	241,9	1
2	18,51	19,00	19,16	19,25	19,30	19,33	19,35	19,37	19,38	19,40	2
3	10,13	9,55	9,28	9,12	9,01	8,94	8,89	8,85	8,81	8,79	3
4	7,71	6,94	6,59	6,39	6,26	6,16	6,09	6,04	6,00	5,96	4
5	6,61	5,79	5,41	5,19	5,05	4,95	4,88	4,82	4,77	4,74	5
6	5,99	5,14	4,76	4,53	4,39	4,28	4,21	4,15	4,10	4,06	6
7	5,59	4,74	4,35	4,12	3,97	3,87	3,79	3,73	3,68	3,64	7
8	5,32	4,46	4,07	3,84	3,69	3,58	3,50	3,44	3,39	3,35	8
9	5,12	4,26	3,86	3,63	3,48	3,37	3,29	3,23	3,18	3,14	9
10	4,96	4,10	3,71	3,48	3,33	3,22	3,14	3,07	3,02	2,98	10
11	4,84	3,98	3,59	3,36	3,20	3,09	3,01	2,95	2,90	2,85	11
12	4,75	3,89	3,49	3,26	3,11	3,00	2,91	2,85	2,80	2,75	12
13	4,67	3,81	3,41	3,18	3,03	2,92	2,83	2,77	2,71	2,67	13
14	4,60	3,74	3,34	3,11	2,96	2,85	2,76	2,70	2,65	2,60	14
15	4,54	3,68	3,29	3,06	2,90	2,79	2,71	2,64	2,59	2,54	15
16	4,49	3,63	3,24	3,01	2,85	2,74	2,66	2,59	2,54	2,49	16
17	4,45	3,59	3,20	2,96	2,81	2,70	2,61	2,55	2,49	2,45	17
18	4,41	3,55	3,16	2,93	2,77	2,66	2,58	2,51	2,46	2,41	18
19	4,38	3,52	3,13	2,90	2,74	2,63	2,54	2,48	2,42	2,38	19
20	4,35	3,49	3,10	2,87	2,71	2,60	2,51	2,45	2,39	2,35	20
21	4,32	3,47	3,07	2,84	2,68	2,57	2,49	2,42	2,37	2,32	21
22	4,30	3,44	3,05	2,82	2,66	2,55	2,46	2,40	2,34	2,30	22
23	4,28	3,42	3,03	2,80	2,64	2,53	2,44	2,37	2,32	2,27	23
24	4,26	3,40	3,01	2,78	2,62	2,51	2,42	2,36	2,30	2,25	24
25	4,24	3,39	2,99	2,76	2,60	2,49	2,40	2,34	2,28	2,24	25
26	4,23	3,37	2,98	2,74	2,59	2,47	2,39	2,32	2,27	2,22	26
27	4,21	3,35	2,96	2,73	2,57	2,46	2,37	2,31	2,25	2,20	27
28	4,20	3,34	2,95	2,71	2,56	2,45	2,36	2,29	2,24	2,19	28
29	4,18	3,33	2,93	2,70	2,55	2,43	2,35	2,28	2,22	2,18	29
30	4,17	3,32	2,92	2,69	2,53	2,42	2,33	2,27	2,21	2,16	30
40	4,08	3,23	2,84	2,61	2,45	2,34	2,25	2,18	2,12	2,08	40
60	4,00	3,15	2,76	2,53	2,37	2,25	2,17	2,10	2,04	1,99	60
120	3,92	3,07	2,68	2,45	2,29	2,17	2,09	2,02	1,96	1,91	120
∞	3,84	3,00	2,60	2,37	2,21	2,10	2,01	1,94	1,88	1,83	∞
v₂	1	2	3	4	5	6	7	8	9	10	v₂

**COMPENDIUM OF INTERNATIONAL ANALYSIS OF METHODS -
OIV**

Guide for the validation – quality control

v1											v1
----	--	--	--	--	--	--	--	--	--	--	----

**COMPENDIUM OF INTERNATIONAL ANALYSIS OF METHODS -
OIV**

Guide for the validation – quality control

Annex N°2

Table B - Law of STUDENT

This table indicates values of **t** in function with **P** and **v**.

v	P	0,55	0,60	0,65	0,70	0,75	0,80	0,85	0,90	0,95	0,975	0,990	0,995	0,9995	P
1		0,158	0,325	0,510	0,727	1,000	1,376	1,963	3,078	6,314	12,706	31,821	63,657	636,619	1
2		0,142	0,289	0,445	0,617	0,816	1,061	1,386	1,886	2,920	4,303	6,965	9,925	31,598	2
3		0,137	0,277	0,424	0,584	0,765	0,978	1,250	1,638	2,353	3,182	4,541	5,841	12,929	3
4		0,134	0,271	0,414	0,569	0,741	0,941	1,190	1,533	2,132	2,776	3,747	4,604	8,610	4
5		0,132	0,267	0,408	0,559	0,727	0,920	1,156	1,476	2,015	2,571	3,365	4,032	6,869	5
6		0,131	0,265	0,404	0,553	0,718	0,906	1,134	1,440	1,943	2,447	3,143	3,707	5,959	6
7		0,130	0,263	0,402	0,549	0,711	0,896	1,119	1,415	1,895	2,365	2,998	3,499	5,408	7
8		0,130	0,262	0,399	0,546	0,706	0,889	1,108	1,397	1,860	2,306	2,896	3,355	5,041	8
9		0,129	0,261	0,398	0,543	0,703	0,883	1,100	1,383	1,833	2,262	2,821	3,250	4,781	9
10		0,129	0,260	0,397	0,542	0,700	0,879	1,093	1,372	1,812	2,228	2,764	3,169	4,587	10
11		0,129	0,260	0,396	0,540	0,697	0,876	1,088	1,363	1,796	2,201	2,718	3,106	4,437	11
12		0,128	0,259	0,395	0,539	0,695	0,873	1,083	1,356	1,782	2,179	2,681	3,055	4,318	12
13		0,128	0,259	0,394	0,538	0,694	0,870	1,079	1,350	1,771	2,160	2,650	3,012	4,221	13
14		0,128	0,258	0,393	0,537	0,692	0,868	1,076	1,345	1,761	2,145	2,624	2,977	4,140	14
15		0,128	0,258	0,393	0,536	0,691	0,866	1,074	1,341	1,753	2,131	2,602	2,947	4,073	15
16		0,128	0,258	0,392	0,535	0,690	0,865	1,071	1,337	1,746	2,120	2,583	2,921	4,015	16
17		0,128	0,257	0,392	0,534	0,689	0,863	1,069	1,333	1,740	2,110	2,567	2,898	3,965	17
18		0,127	0,257	0,392	0,534	0,688	0,862	1,067	1,330	1,734	2,101	2,552	2,878	3,922	18
19		0,127	0,257	0,391	0,533	0,688	0,861	1,066	1,328	1,729	2,093	2,539	2,861	3,883	19
20		0,127	0,257	0,391	0,533	0,687	0,860	1,064	1,325	1,725	2,086	2,528	2,845	3,850	20
21		0,127	0,257	0,391	0,532	0,686	0,859	1,063	1,323	1,721	2,080	2,518	2,831	3,819	21
22		0,127	0,256	0,390	0,532	0,686	0,858	1,061	1,321	1,717	2,074	2,508	2,819	3,792	22
23		0,127	0,256	0,390	0,532	0,685	0,858	1,060	1,319	1,714	2,069	2,500	2,807	3,767	23
24		0,127	0,256	0,390	0,531	0,685	0,857	1,059	1,318	1,711	2,064	2,492	2,797	3,745	24
25		0,127	0,256	0,390	0,531	0,684	0,856	1,058	1,316	1,708	2,060	2,485	2,787	3,725	25
26		0,127	0,256	0,390	0,531	0,684	0,856	1,058	1,315	1,706	2,056	2,479	2,779	3,707	26
27		0,127	0,256	0,389	0,531	0,684	0,855	1,057	1,314	1,703	2,052	2,473	2,771	3,690	27
28		0,127	0,256	0,389	0,530	0,683	0,855	1,056	1,313	1,701	2,048	2,467	2,763	3,674	28
29		0,127	0,256	0,389	0,530	0,683	0,854	1,055	1,311	1,699	2,045	2,462	2,756	3,659	29
30		0,127	0,256	0,389	0,530	0,683	0,854	1,055	1,310	1,697	2,042	2,457	2,750	3,646	30
40		0,126	0,255	0,388	0,529	0,681	0,851	1,050	1,303	1,684	2,021	2,423	2,704	3,551	40
60		0,126	0,254	0,387	0,527	0,679	0,848	1,046	1,296	1,671	2,000	2,390	2,660	3,460	60
120		0,126	0,254	0,386	0,526	0,677	0,845	1,041	1,289	1,658	1,980	2,358	2,617	3,373	120
∞		0,126	0,253	0,385	0,524	0,674	0,842	1,036	1,282	1,645	1,960	2,326	2,576	3,291	∞
v	P	0,55	0,60	0,65	0,70	0,75	0,80	0,85	0,90	0,95	0,975	0,990	0,995	0,9995	v

**Harmonised guidelines for single-laboratory validation of
methods of analysis (technical report)**

(Resolution OENO 8/2005)

Synopsis

Method validation is one of the measures universally recognised as a necessary part of a comprehensive system of quality assurance in analytical chemistry. In the past ISO, IUPAC and AOAC INTERNATIONAL have co-operated to produce agreed protocols or guidelines on the “Design, Conduct and Interpretation of Method Performance Studies”¹, on the “Proficiency Testing of (Chemical) Analytical Laboratories”², on “Internal Quality Control in Analytical Chemistry Laboratories”³, and on “The Use of Recovery Information in Analytical Measurement”⁴. (from the usage of overlapping data in analytical measurements) The Working Group that produced these protocols/guidelines has now been mandated by IUPAC to prepare guidelines on the Single-laboratory Validation of methods of analysis. These guidelines provide minimum recommendations on procedures that should be employed to ensure adequate validation of analytical methods.

A draft of the guidelines has been discussed at an International Symposium on the Harmonisation of Quality Assurance Systems in Chemical Laboratory, the Proceedings from which have been published by the UK Royal Society of Chemistry.

Resulting from the Symposium on Harmonisation of Quality Assurance
Systems for Analytical Laboratories, Budapest, Hungary, 4-5 November 1999
held under the sponsorship of IUPAC, ISO and AOAC INTERNATIONAL

**COMPENDIUM OF INTERNATIONAL ANALYSIS OF METHODS -
OIV
Single laboratory validation**

CONTENTS

1	INTRODUCTION
1.1	Background
1.2	Existing protocols, standards and guides
2	DEFINITIONS AND TERMINOLOGY
2.1	General
2.2	Definitions used in this guide
3	Method validation, uncertainty, and quality assurance
4	BASIC PRINCIPLES OF METHOD VALIDATION
4.1	Specification and scope of validation
4.2	Testing assumptions
4.3	Sources of Error in Analysis
4.4	Method and Laboratory effects
5	Conduct of Validation Studies
6	Extent of validation studies
6.1	The laboratory is to use a “fully” validated method
6.2	The laboratory is to use a fully validated method, but new matrix is to be used
6.3	The laboratory is to use a well-established, but not collaboratively studied, method
6.4	The method has been published in the scientific literature together with some analytical characteristics
6.5	The method has been published in the scientific literature with no characteristics given or has been developed in-house
6.6	The method is empirical
6.7	The analysis is “ad hoc”
6.8	Changes in staff and equipment
7	RECOMMENDATIONS
8	BIBLIOGRAPHY

**COMPENDIUM OF INTERNATIONAL ANALYSIS OF METHODS -
OIV
Single laboratory validation**

ANNEX A: NOTES ON THE REQUIREMENTS FOR STUDY OF METHOD PERFORMANCE CHARACTERISTICS.

- A1 Applicability
- A2 Selectivity
- A3 Calibration and linearity
 - A3.1 Linearity and intercept*
 - A3.2 Test for general matrix effect*
 - A3.3 Final calibration procedure*
- A4 Trueness
 - A4.1 Estimation of trueness*
 - A4.2 Conditions for trueness experiments*
 - A4.3 Reference values for trueness experiments*
 - A4.3.1 Certified reference materials (CRMs)*
 - A4.3.2 Reference materials
 - A4.3.3 Use of a reference method
 - A4.3.4 Use of spiking/recovery
- A5 Accuracy
- A6 Recovery
- A7 Concentration range
- A8 Detection Limit
- A9 Limit of determination or limit of quantification
- A10 Sensitivity
- A11 Ruggedness
- A12 Fitness for trial purposes
- A13 Matrix variation
- A14. Measurement Uncertainty

**COMPENDIUM OF INTERNATIONAL ANALYSIS OF METHODS -
OIV
Single laboratory validation**

ANNEX B. ADDITIONAL CONSIDERATIONS FOR UNCERTAINTY
ESTIMATION IN VALIDATION STUDIES

- B1 Sensitivity analysis
- B2 Judgement

1. INTRODUCTION

1.1 Background

Reliable analytical methods are required for compliance with national and international regulations in all areas of analysis. It is accordingly internationally recognised that a laboratory must take appropriate measures to ensure that it is capable of providing and does provide data of the required quality. Such measures include:

- using validated methods of analysis;
- using internal quality control procedures;
- participating in proficiency testing schemes; and
- becoming accredited to an International Standard, normally ISO/IEC 17025.

It should be noted that accreditation to ISO/IEC 17025 specifically addresses the establishment of traceability for measurements, as well as requiring a range of other technical and management requirements including all those in the list above.

Method validation is therefore an essential component of the measures that a laboratory should implement to allow it to produce reliable analytical data. Other aspects of the above have been addressed previously by the IUPAC Interdivisional Working Party on Harmonisation of Quality Assurance Schemes for Analytical Laboratories, specifically by preparing Protocols/Guidelines on method performance (collaborative) studies,¹ proficiency testing,² and internal quality control.³

In some sectors, most notably in the analysis of food, the requirement for methods that have been “fully validated” is prescribed by legislation.^{5,6} “Full” validation for an analytical method is usually taken to comprise an examination of the characteristics of the method in an inter-laboratory method performance study (also known as a collaborative study or collaborative trial). Internationally accepted protocols have been established for the “full” validation of a method of analysis by a collaborative trial, most notably the International Harmonised Protocol¹ and the ISO procedure.⁷ These protocols/standards require a minimum number of laboratories and test materials to be included in the collaborative trial to validate fully the analytical method. However, it is not always practical or necessary to provide full validation of analytical methods. In such circumstances a “single-laboratory method validation” may be appropriate.

**COMPENDIUM OF INTERNATIONAL ANALYSIS OF METHODS -
OIV
Single laboratory validation**

Single-laboratory method validation is appropriate in several circumstances including the following:

- to ensure the viability of the method before the costly exercise of a formal collaborative trial;
- to provide evidence of the reliability of analytical methods if collaborative trial data are not available or where the conduct of a formal collaborative trial is not practicable;
- to ensure that “off-the-shelf” validated methods are being used correctly.

When a method is to be characterised in-house, it is important that the laboratory determines and agrees with its customer exactly which characteristics are to be evaluated. However, in a number of situations these characteristics may be laid down by legislation (e.g. veterinary drug residues in food and pesticides in food sectors). The extent of the evaluation that a laboratory undertakes must meet the requirements of legislation.

Nevertheless in some analytical areas the same analytical method is used by a large number of laboratories to determine stable chemical compounds in defined matrices. It should be appreciated that if a suitable collaboratively studied method can be made available to these laboratories, then the costs of the collaborative trial to validate that method may well be justified. The use of a collaboratively studied method considerably reduces the efforts which a laboratory, before taking a method into routine use, must invest in extensive validation work. A laboratory using a collaboratively studied method, which has been found to be fit for the intended purpose, needs only to demonstrate that it can achieve the performance characteristics stated in the method. Such a verification of the correct use of a method is much less costly than a full single laboratory validation. The total cost to the Analytical Community of validating a specific method through a collaborative trial and then verifying its performance attributes in the laboratories wishing to use it is frequently less than when many laboratories all independently undertake single laboratory validation of the same method.

1.2 Existing Protocols, Standards and Guides

A number of protocols and guidelines⁸⁻¹⁹ on method validation and uncertainty have been prepared, most notably in AOAC INTERNATIONAL, International Conference on Harmonisation (ICH) and Eurachem documents:

- The Statistics manual of the AOAC, which includes guidance on single laboratory study prior to collaborative testing¹³.

**COMPENDIUM OF INTERNATIONAL ANALYSIS OF METHODS -
OIV
Single laboratory validation**

- The ICH text¹⁵ and methodology,¹⁶ which prescribe minimum validation study requirements for tests used to support drug approval submission.
- The Fitness for Purpose of Analytical Methods: A Laboratory Guide to Method Validation and Related Topics (1998)¹².
- Quantifying Uncertainty in Analytical Measurement (2000)⁹.

Method validation was also extensively discussed at a Joint FAO/IAEA Expert Consultation, December 1997, on the Validation of Analytical Methods for Food Controls, the Report of which is available¹⁹.

The present 'Guidelines' bring together the essential scientific principles of the above documents to provide information which has been subjected to international acceptance and, more importantly, to point the way forward for best practice in single-laboratory method validation.

2 DEFINITIONS AND TERMINOLOGY

2.1 General

Terms used in this document respect ISO and IUPAC definitions where available. The following documents contain relevant definitions:

- i) IUPAC: Compendium of chemical terminology, 1987
- ii) International vocabulary of basic and general terms in metrology. ISO 1993

2.2 Definitions used in this guide only:

Relative uncertainty: Uncertainty expressed as a relative standard deviation.

Validated range: That part of the concentration range of an analytical method which has been subjected to validation.

3 METHOD VALIDATION, UNCERTAINTY, AND QUALITY ASSURANCE

Method validation makes use of a set of tests which both test any assumptions on which the analytical method is based and establish and document the performance characteristics of a method, thereby demonstrating whether the method is fit for a particular analytical purpose. Typical performance characteristics of analytical methods are: applicability; selectivity; calibration; trueness; precision; recovery; operating range; limit of quantification; limit of detection; sensitivity; and ruggedness. To these can be added measurement uncertainty and fitness-for-purpose.

Strictly speaking, validation should refer to an ‘analytical system’ rather than an ‘analytical method’, the analytical system comprising a defined method protocol, a defined concentration range for the analyte, and a specified type of test material. For the purposes of this document, a reference to ‘method validation’ will be taken as referring to an analytical system as a whole. Where the analytical procedure as such is addressed, it will be referred to as ‘the protocol’.

In this document method validation is regarded as distinct from ongoing activities such as internal quality control (IQC) or proficiency testing. Method validation is carried out once, or at relatively infrequent intervals during the working lifetime of a method; it tells us what performance we can expect the method to provide in the future. Internal quality control tells us about how the method has performed in the past. IQC is therefore treated as a separate activity in the IUPAC Harmonisation Programme.³

In method validation the quantitative characteristics of interest relate to the accuracy of the result likely to be obtained. Therefore it is generally true to say that method validation is tantamount to the task of estimating uncertainty of measurement. Over the years it has become traditional for validation purposes to represent different aspects of method performance by reference to the separate items listed above, and to a considerable extent these guidelines reflect that pattern. However, with an increasing reliance on measurement uncertainty as a key indicator of both fitness for purpose and reliability of results, analytical chemists will increasingly undertake measurement validation to support uncertainty estimation, and some practitioners will want to do so immediately. Accordingly, measurement uncertainty is treated briefly in Annex A as a performance characteristic of an analytical method, while Annex B provides additional guidance on some procedures not otherwise covered.

4 BASIC PRINCIPLES OF METHOD VALIDATION

4.1 Specification and scope of validation

Validation applies to a defined protocol, for the determination of a specified analyte and range of concentrations in a particular type of test material, used for a specified purpose. In general, validation should check that the method performs adequately for the purpose throughout the range of analyte concentrations and test materials to which it is applied. It follows that these features, together with a statement of any fitness-for-purpose criteria, should be completely specified before any validation takes place.

4.2 Testing assumptions

In addition to the provision of performance figures which indicate fitness for purpose and have come to dominate the practical use of validation data, validation studies act as an objective test of any assumptions on which an analytical method is based. For example, if a result is to be calculated from a simple straight line calibration function, it is implicitly assumed that the analysis is free from significant bias, that the response is proportional to analyte concentration, and that the dispersion of random errors is constant throughout the range of interest. In most circumstances, such assumptions are made on the basis of experience accumulated during method development or over the longer term, and are consequently reasonably reliable. Nonetheless, good measurement science relies on *tested* hypotheses. This is the reason that so many validation studies are based on statistical hypothesis testing; the aim is to provide a basic check that the reasonable assumptions made about the principles of the method are not seriously flawed.

There is an important practical implication of this apparently abstruse note. It is easier to check for gross departure from a reliable assumption than to 'prove' that a particular assumption is correct. Thus, where there is long practice of the successful use of a particular analytical technique (such as gas chromatographic analysis, or acid digestion methods) across a range of analytes and matrices, validation checks justifiably take the form of relatively light precautionary tests. Conversely, where experience is slight, the validation study needs to provide strong evidence that the assumptions made are appropriate in the particular cases under study, and it will generally be necessary to study the full range of circumstances in detail. It follows that the extent of validation studies required in a given instance will depend, in part, on the accumulated experience of the analytical technique used.

In the following discussion, it will be taken for granted that the laboratory is well

practised in the technique of interest, and that the purpose of any significance tests is to check that there is no strong evidence to discount the assumptions on which the particular protocol relies. The reader should bear in mind that more stringent checks may be necessary for unfamiliar or less established measurement techniques.

4.3 Sources of Error in Analysis

Errors in analytical measurements arise from different sources* and at different levels of organisation. One useful way of representing these sources (for a specific concentration of analyte) is as follows⁺²⁴:

- random error of measurement (repeatability);
- run bias ;
- laboratory bias;
- method bias;
- matrix variation effect.

Though these different sources may not necessarily be independent, this list provides a useful way of checking the extent to which a given validation study addresses the sources of error.

The repeatability (within-run) term includes contributions from any part of the procedure that varies within a run, including contributions from the familiar gravimetric and volumetric errors, heterogeneity of the test material, and variation in the chemical treatment stages of the analysis, and is easily seen in the dispersion of replicated analyses. The run effect accounts for additional day-to-day variations in the analytical system, such as changes of analyst, batches of reagents, recalibration of instruments, and the laboratory environment (*e.g.*, temperature changes). In single-laboratory validation, the run effect is typically estimated by

* Sampling uncertainty in the strict sense of uncertainty due to the preparation of the laboratory sample from the bulk target is excluded from consideration in this document. Uncertainty associated with taking a test portion from the laboratory sample is an inseparable part of measurement uncertainty and is automatically included at various levels of the following analysis.

⁺ Many alternative groupings or ‘partitions of error’ are possible and may be useful in studying particular sources of error in more detail or across a different range of situations. For example, the statistical model of ISO 5725 generally combines laboratory and run effects, while the uncertainty estimation procedure in the ISO GUM is well suited to assessing the effects of each separate and measurable influence on the result.

**COMPENDIUM OF INTERNATIONAL ANALYSIS OF METHODS -
OIV**

Single laboratory validation

conducting a designed experiment with replicated analysis of an appropriate material in a number of separate runs. Between-laboratory variation arises from factors such as variations in calibration standards, differences between local interpretations of a protocol, changes in equipment or reagent source or environmental factors, such as differences in average climatic conditions. Between-laboratory variation is clearly seen as a reality in the results of collaborative trials (method performance studies) and proficiency tests, and between-method variation can sometimes be discerned in the results of the latter.

Generally, the repeatability, run effect and laboratory effect are of comparable magnitude, so none can safely be ignored in validation. In the past there has been a tendency for aspects to be neglected, particularly when estimating and reporting uncertainty information. This results in uncertainty intervals that are too tight. For example, the collaborative trial as normally conducted does not give the complete picture because contributions to uncertainty from method bias and matrix variation are not estimated in collaborative trials and have to be addressed separately (usually by prior single-laboratory study). In single-laboratory validation there is the particular danger that laboratory bias also may be overlooked, and that item is usually the largest single contributor to uncertainty from the above list. Therefore specific attention must be paid to laboratory bias in single-laboratory validation.

In addition to the above-mentioned problems, the validation of a method is limited to the scope of its application, that is, the method as applied to a particular class of test material. If there is a substantial variation of matrix types within the defined class, there will be an additional source of variation due to within-class matrix effects. Of course, if the method is subsequently used for materials outside the defined class (that is, outside the scope of the validation), the analytical system cannot be considered validated: an extra error of unknown magnitude is introduced into the measurement process.

It is also important for analysts to take account of the way in which method performance varies as a function of the concentration of the analyte. In most instances the dispersion of results increases absolutely with concentration and recovery may differ substantially at high and low concentrations. The measurement uncertainty associated with the results is therefore often dependent on both these effects and on other concentration-dependent factors. Fortunately, it is often reasonable to assume a simple relationship between performance and analyte concentration; most commonly that errors are proportional to analyte concentration.* However, where the performance of the method is of interest at substantially different concentrations, it is important to check the assumed

* This may not be applicable at concentrations less than 10 times the detection limit.

relationship between performance and analyte concentration. This is typically done by checking performance at extremes of the likely range, or at a few selected levels. Linearity checks also provide information of the same kind.

4.4 Method and Laboratory effects

It is critically important in single-laboratory method validation to take account of method bias and laboratory bias. There are a few laboratories with special facilities where these biases can be regarded as negligible, but that circumstance is wholly exceptional. (However, that if there is only one laboratory carrying out a particular analysis, then method bias and laboratory bias take on a different perspective). Normally, method and laboratory effects have to be included in the uncertainty budget, but often they are more difficult to address than repeatability error and the run effect. In general, to assess the respective uncertainties it is necessary to use information gathered independently of the laboratory. The most generally useful sources of such information are (i) statistics from collaborative trials (not available in many situations of single-laboratory method validation), (ii) statistics from proficiency tests and (iii) results from the analysis of certified reference materials.

Collaborative trials directly estimate the variance of between-laboratory biases. While there may be theoretical shortcomings in the design of such trials, these variance estimates are appropriate for many practical purposes. Consequently it is always instructive to test single-laboratory validation by comparing the estimates of uncertainty with reproducibility estimates from collaborative trials. If the single-laboratory result is substantially the smaller, it is likely that important sources of uncertainty have been neglected. (Alternatively, it may be that a particular laboratory in fact works to a smaller uncertainty than found in collaborative trials: such a laboratory would have to take special measures to justify such a claim.) If no collaborative trial has been carried out on the particular method/test material combination, an estimate of the reproducibility standard deviation ζ_H at an analyte concentration c above about 120 ppb can usually be obtained from the Horwitz function, $\zeta_H = 0.02c^{0.8495}$, with both variables expressed as mass fractions. (The Horwitz estimate is normally within a factor of about two of observed collaborative study results). It has been observed that the Horwitz function is incorrect at concentrations lower than about 120 ppb, and a modified function is more appropriate.^{21, 25} All of this information may be carried into the single-laboratory area with minimum change.

Statistics from proficiency tests are particularly interesting because they provide information in general about the magnitude of laboratory and method biases

combined and, for the participant, information about total error on specific occasions. Statistics such as the robust standard deviation of the participants results for an analyte in a round of the test can in principle be used in a way similar to reproducibility standard deviations from collaborative trials, *i.e.*, to obtain a benchmark for overall uncertainty for comparison with individual estimates from single-laboratory validation. In practice, statistics from proficiency tests may be more difficult to access, because they are not systematically tabulated and published like collaborative trials, but only made available to participants. Of course, if such statistics are to be used they must refer to the appropriate matrix and concentration of the analyte. Individual participants in proficiency testing schemes can also gauge the validity of their estimated uncertainty by comparing their reported results with the assigned values of successive rounds²⁶. This, however, is an ongoing activity and therefore not strictly within the purview of single-laboratory validation (which is a one-off event).

If an appropriate certified reference material is available, a single-laboratory test allows a laboratory to assess laboratory bias and method bias in combination, by analysing the CRM a number of times. The estimate of the combined bias is the difference between the mean result and the certified value.

Appropriate certified reference materials are not always available, so other materials may perforce have to be used. Materials left over from proficiency tests sometimes serve this purpose and, although the assigned values of the materials may have questionable uncertainties, their use certainly provides a check on overall bias. Specifically, proficiency test assigned values are generally chosen to provide a minimally biased estimate, so a test for significant bias against such a material is a sensible practice. A further alternative is to use spiking and recovery information⁴ to provide estimates of these biases, although there may be unmeasurable sources of uncertainty associated with these techniques.

Currently the least recognised effect in validation is that due to matrix variation within the defined class of test material. The theoretical requirement for the estimation of this uncertainty component is for a representative collection of test materials to be analysed in a single run, their individual biases estimated, and the variance of these biases calculated. (Analysis in a single run means that higher level biases have no effect on the variance. If there is a wide concentration range involved, then allowance for the change in bias with concentration must be made.) If the representative materials are certified reference materials, the biases can be estimated directly as the differences between the results and the reference values, and the whole procedure is straightforward. In the more likely event that insufficient number of certified reference materials are available, recovery tests with a range of typical test materials may be resorted to, with due caution. Currently there is very little quantitative information about the magnitude of

**COMPENDIUM OF INTERNATIONAL ANALYSIS OF METHODS -
OIV
Single laboratory validation**

uncertainties from this source, although in some instances they are suspected of being large.

5 Conduct of Validation Studies

The detailed design and execution of method validation studies is covered extensively elsewhere and will not be repeated here. However, the main principles are pertinent and are considered below:

It is essential that validation studies are representative. That is, studies should, as far as possible, be conducted to provide a realistic survey of the number and range of effects operating during normal use of the method, as well as to cover the concentration ranges and sample types within the scope of the method. Where a factor (such as ambient temperature) has varied representatively at random during the course of a precision experiment, for example, the effects of that factor appear directly in the observed variance and need no additional study unless further method optimisation is desirable.

In the context of method validation, “representative variation” means that the factor must take a distribution of values appropriate to the anticipated range of the parameter in question. For continuous measurable parameters, this may be a permitted range, stated uncertainty or expected range; for discontinuous factors, or factors with unpredictable effects such as sample matrix, a representative range corresponds to the variety of types or “factor levels” permitted or encountered in normal use of the method. Ideally, representativeness extends not only to the range of values, but to their distribution. Unfortunately, it is often uneconomic to arrange for full variation of many factors at many levels. For most practical purposes, however, tests based on extremes of the expected range, or on larger changes than anticipated, are an acceptable minimum.

In selecting factors for variation, it is important to ensure that the larger effects are ‘exercised’ as much as possible. For example, where day to day variation (perhaps arising from recalibration effects) is substantial compared to repeatability, two determinations on each of five days will provide a better estimate of intermediate precision than five determinations on each of two days. Ten single determinations on separate days will be better still, subject to sufficient control, though this will provide no additional information on within-day repeatability.

Clearly, in planning significance checks, any study should have sufficient power to detect such effects before they become practically important (that is, comparable to the largest component of uncertainty).

In addition, the following considerations may be important:

- Where factors are known or suspected to interact, it is important to ensure that the effect of interaction is accounted for. This may be achieved either by ensuring random selection from different levels of interacting parameters, or by careful systematic design to obtain 'interaction' effects or covariance information.
- In carrying out studies of overall bias, it is important that the reference materials and values are relevant to the materials under routine test.

6 Extent of validation studies

The extent to which a laboratory has to undertake validation of a new, modified or unfamiliar method depends to a degree on the existing status of the method and the competence of the laboratory. Suggestions as to the extent of validation and verification measures for different circumstances are given below. Except where stated, it is assumed that the method is intended for routine use.

6.1 The laboratory is to use a “fully” validated method

The method has been studied in a collaborative trial and so the laboratory has to verify that it is capable of achieving the published performance characteristics of the method (or is otherwise able to fulfil the requirements of the analytical task). The laboratory should undertake precision studies, bias studies (including matrix variation studies), and possibly linearity studies, although some tests such as that for ruggedness may be omitted.

6.2 The laboratory is to use a fully validated method, but new matrix is to be used

The method has been studied in a collaborative trial and so the laboratory has to verify that the new matrix introduces no new sources of error into the system. The same range of validation as the previous is required.

6.3 The laboratory is to use a well-established, but not collaboratively studied, method

The same range of validation as the previous is required.

6.4 The method has been published in the scientific literature together with some analytical characteristics

The laboratory should undertake precision studies, bias studies (including matrix variation studies), ruggedness and linearity studies.

6.5 The method has been published in the scientific literature with no characteristics given or has been developed in-house

The laboratory should undertake precision studies, bias studies (including matrix variation studies), ruggedness and linearity studies.

6.6 The method is empirical

An empirical method is one in which the quantity estimated is simply the result found on following the stated procedure. This differs from measurements intended to assess method-independent quantities such as the concentration of a particular analyte in a sample, in that the method bias is conventionally zero, and matrix variation (that is, within the defined class) is irrelevant. Laboratory bias cannot be ignored, but is likely to be difficult to estimate by single-laboratory experiment. Moreover, reference materials are unlikely to be available. In the absence of collaborative trial data some estimate of interlaboratory precision could be obtained from a specially designed ruggedness study or estimated by using the Horwitz function.

6.7 The analysis is “ad hoc”

“Ad hoc” analysis is occasionally necessary to establish the general range of a value, without great expenditure and with low criticality. The effort that can go into validation is accordingly strictly limited. Bias should be studied by methods such as recovery estimation or analyte additions, and precision by replication.

6.8 Changes in staff and equipment

Important examples include: change in major instruments; new batches of very variable reagents (for example, polyclonal antibodies); changes made in the laboratory premises; methods used for the first time by new staff; or a validated method employed after a period of disuse. Here the essential action is to demonstrate that no deleterious changes have occurred. The minimum check is a single bias test; a “before and after” experiment on typical test materials or control

**COMPENDIUM OF INTERNATIONAL ANALYSIS OF METHODS -
OIV
Single laboratory validation**

materials. In general, the tests carried out should reflect the possible impact of the change on the analytical procedure.

7 RECOMMENDATIONS

The following recommendations are made regarding the use of single-laboratory method validation:

- Wherever possible and practical a laboratory should use a method of analysis that has had its performance characteristics evaluated through a collaborative trial conforming to an international protocol.
- Where such methods are not available, a method must be validated in-house before being used to generate analytical data for a customer.
- Single-laboratory validation requires the laboratory to select appropriate characteristics for evaluation from the following: applicability, selectivity, calibration, accuracy, precision, range, limit of quantification, limit of detection, sensitivity, ruggedness and practicability. The laboratory must take account of customer requirements in choosing which characteristics are to be determined.
- Evidence that these characteristics have been assessed must be made available to customers of the laboratory if required by the customer.

8 REFERENCES

1. *"Protocol for the Design, Conduct and Interpretation of Method Performance Studies"*, W Horwitz, *Pure Appl. Chem.*, 1988, **60**, 855-864, revised W. Horwitz, *Pure Appl. Chem.*, 1995, **67**, 331-343.
2. *"The International Harmonised Protocol for the Proficiency Testing of (Chemical) Analytical Laboratories"*, M Thompson and R Wood, *Pure Appl. Chem.*, 1993, **65**, 2123-2144. (Also published in *J. AOAC International*, 1993, **76**, 926-940.
3. *"Harmonised Guidelines For Internal Quality Control in Analytical Chemistry Laboratories"*, Michael Thompson and Roger Wood, *J. Pure & Applied Chemistry*, 1995, **67(4)**, 49-56.
4. *"Harmonised Guidelines for the Use of Recovery Information in Analytical Measurement"*, Michael Thompson, Stephen Ellison, Ales Fajgelj, Paul Willetts and Roger Wood, *J. Pure & Applied Chemistry*, 1999, **71(2)**, 337-348.

**COMPENDIUM OF INTERNATIONAL ANALYSIS OF METHODS -
OIV
Single laboratory validation**

5. *“Council Directive 93/99/EEC on the Subject of Additional Measures Concerning the Official Control of Foodstuffs”*, O. J., 1993, L290.
6. *“Procedural Manual of the Codex Alimentarius Commission, 10th Edition”*, FAO, Rome, 1997.
7. *“Precision of Test Methods”*, Geneva, 1994, ISO 5725, Previous editions were issued in 1981 and 1986.
8. *“Guide to the Expression of Uncertainty in Measurement”*, ISO, Geneva, 1993.
9. *“Quantifying Uncertainty in Analytical Measurement”*, EURACHEM Secretariat, Laboratory of the Government Chemist, Teddington, UK, 1995, EURACHEM Guide (under revision).
10. *“International vocabulary of basic and general terms in metrology”* ISO, Geneva 1993
11. *“Validation of Chemical Analytical Methods”*, NMKL Secretariat, Finland, 1996, NMKL Procedure No. 4.
12. *“EURACHEM Guide: The fitness for purpose of analytical methods. A Laboratory Guide to method validation and related topics”*, LGC, Teddington 1996. Also available from the EURACHEM Secretariat and website.
13. *“Statistics manual of the AOAC”*, AOAC INTERNATIONAL, Gaithersburg, Maryland, USA, 1975
14. *“An Interlaboratory Analytical Method Validation Short Course developed by the AOAC INTERNATIONAL”*, AOAC INTERNATIONAL, Gaithersburg, Maryland, USA, 1996.
15. *“Text on validation of analytical procedures”* International Conference on Harmonisation. Federal Register, Vol. 60, March 1, 1995, pages 11260
16. *“Validation of analytical procedures: Methodology”* International Conference on Harmonisation. Federal Register, Vol. 62, No. 96, May 19, 1997, pages 27463-27467.

**COMPENDIUM OF INTERNATIONAL ANALYSIS OF METHODS -
OIV
Single laboratory validation**

17. “*Validation of Methods*”, Inspectorate for Health Protection, Rijswijk, The Netherlands, Report 95-001.
18. “*A Protocol for Analytical Quality Assurance in Public Analysts’ Laboratories*”, Association of Public Analysts, 342 Coleford Road, Sheffield S9 5PH, UK, 1986.
19. “*Validation of Analytical Methods for Food Control*”, Report of a Joint FAO/IAEA Expert Consultation, December 1997, FAO Food and Nutrition Paper No. 68, FAO, Rome, 1998
20. “*Estimation and Expression of Measurement Uncertainty in Chemical Analysis*”, NMKL Secretariat, Finland, 1997, NMKL Procedure No. 5.
21. M Thompson, PJ Lowthian, *JAOAC Int*, 1997, **80**, 676-679
22. IUPAC recommendation: “*Nomenclature in evaluation of analytical methods, including quantification and detection capabilities*” *Pure and Applied Chem.* 1995, **67** 1699-1723
23. ISO 11843. “*Capability of detection.*” (Several parts). International Standards Organisation, Geneva.
24. M. Thompson, *Analyst*, 2000, **125**, 2020-2025
25. “*Recent trends in inter-laboratory precision at ppb and sub-ppb concentrations in relation to fitness for purpose criteria in proficiency testing*” M Thompson, *Analyst*, 2000, **125**, 385-386.
26. “*How to combine proficiency test results with your own uncertainty estimate - the zeta score*”, Analytical Methods Committee of the Royal Society of Chemistry, AMC Technical Briefs, editor M. Thompson, *AMC Technical Brief No. 2*, www.rsc.org/lap/rsccom/amc

ANNEX A: Notes on the requirements for study of method performance characteristics

The general requirements for the individual performance characteristics for a method are as follows.

A1 Applicability

After validation the documentation should provide, in addition to any performance specification, the following information:

- the identity of the analyte, including speciation where appropriate (Example: ‘total arsenic’);
- the concentration range covered by the validation (Example: ‘0-50 ppm’);
- a specification of the range of matrices of the test material covered by the validation (Example: ‘seafood’);
- a protocol, describing the equipment, reagents, procedure (including permissible variation in specified instructions, e.g., ‘heat at $100 \pm 5^\circ$ for 30 ± 5 minutes’), calibration and quality procedures, and any special safety precautions required;
- the intended application and its critical uncertainty requirements (Example: ‘The analysis of food for screening purposes. The standard uncertainty $u(c)$ of the result c should be less than $0.1 \times c$.’).

A2 Selectivity

Selectivity is the degree to which a method can quantify the analyte accurately in the presence of interferents. Ideally, selectivity should be evaluated for any important interferent likely to be present. It is particularly important to check interferents which are likely, on chemical principles, to respond to the test. For example, colorimetric tests for ammonia might reasonably be expected to respond to primary aliphatic amines. It may be impracticable to consider or test every potential interferent; where that is the case, it is recommended that the likely worst cases are checked. As a general principle, selectivity should be sufficiently good for any interferences to be ignored.

In many types of analysis, selectivity is essentially a qualitative assessment based on the significance or otherwise of suitable tests for interference. However, there are useful quantitative measures. In particular, one quantitative measure is the selectivity index b_{an}/b_{int} , where b_{an} is the sensitivity of the method (slope of the

calibration function) and b_{int} the slope of the response independently produced by a potential interferent, provides a quantitative measure of interference. b_{int} can be determined approximately by execution of the procedure on a matrix blank and the same blank spiked with the potential interferent at one appropriate concentration. If a matrix blank is unavailable, and a typical material used instead, b_{int} can be estimated from such a simple experiment only under the assumption that mutual matrix effects are absent. Note that b_{int} is more easily determined in the absence of the analyte because the effect might be confused with another type of interference when the sensitivity of the analyte is itself affected by the interferent (a matrix effect).

A3 Calibration and linearity

With the exception of gross errors in preparation of calibration materials, calibration errors are usually (but not always) a minor component of the total uncertainty budget, and can usually be safely subsumed into various categories estimated by “top-down” methods. For example random errors resulting from calibration are part of the run bias, which is assessed as a whole, while systematic errors from that source may appear as laboratory bias, likewise assessed as a whole. Never-the-less, there are some characteristics of calibration that are useful to know at the outset of method validation, because they affect the strategy for the optimal development of the procedure. In this class are such questions as whether the calibration function plausibly (a) is linear, (b) passes through the origin and (c) is unaffected by the matrix of the test material. The procedures described here relate to calibration studies in validation, which are necessarily more exacting than calibration undertaken during routine analysis. For example, once it is established at validation that a calibration function is linear and passes through the origin, a much simpler calibration strategy can be used for routine use (for example, a two point repeated design). Errors from this simpler calibration strategy will normally be subsumed into higher level errors for validation purposes.

A3.1 Linearity and intercept

Linearity can be tested informally by examination of a plot of residuals produced by linear regression of the responses on the concentrations in an appropriate calibration set. Any curved pattern suggests lack of fit due to a non-linear calibration function. A test of significance can be undertaken by comparing the lack-of-fit variance with that due to pure error. However, there are causes of lack of fit other than nonlinearity that can arise in certain types of analytical calibration, so the significance test must be used in conjunction with a residual plot. Despite its current widespread use as an indication of quality of fit, the correlation coefficient

**COMPENDIUM OF INTERNATIONAL ANALYSIS OF METHODS -
OIV
Single laboratory validation**

is misleading and inappropriate as a test for linearity and should not be used.

Design is all-important in tests for lack of fit, because it is easy to confound nonlinearity with drift. Replicate measurements are needed to provide an estimate of pure error if there is no independent estimate. In the absence of specific guidance, the following should apply:

- there should be six or more calibrators;
- the calibrators should be evenly spaced over the concentration range of interest;
- the range should encompass 0-150% or 50-150% of the concentration likely to be encountered, depending on which of these is the more suitable;
- the calibrators should be run at least in duplicate, and preferably triplicate or more, in a random order.

After an exploratory fit with simple linear regression, the residuals should be examined for obvious patterns. Heteroscedasticity is quite common in analytical calibration and a pattern suggesting it means that the calibration data are best treated by weighted regression. Failure to use weighted regression in these circumstances could give rise to exaggerated errors at the low end of the calibration function.

The test for lack of fit can be carried out with either simple or weighted regression. A test for an intercept significantly different from zero can also be made on this data if there is no significant lack of fit.

A3.2 Test for general matrix effect

It simplifies calibration enormously if the calibrators can be prepared as a simple solution of the analyte. The effects of a possible general matrix mismatch must be assessed in validation if this strategy is adopted. A test for general matrix effect can be made by applying the method of analyte additions (also called “standard additions”) to a test solution derived from a typical test material. The test should be done in a way that provides the same final dilution as the normal procedure produces, and the range of additions should encompass the same range as the procedure-defined calibration validation. If the calibration is linear the slopes of the usual calibration function and the analyte additions plot can be compared for significant difference. A lack of significance means that there is no detectable general matrix effect. If the calibration is not linear a more complex method is needed for a significance test, but a visual comparison at equal concentrations will usually suffice. A lack of significance in this test will often mean that the matrix

variation effect [Section A13] will also be absent.

A3.3 Final calibration procedure

The calibration strategy as specified in the procedure may also need to be separately validated, although the errors involved will contribute to jointly estimated uncertainties. The important point here is that evaluation uncertainty estimated from the specific designs for linearity etc., will be smaller than those derived from the simpler calibration defined in the procedure protocol.

A4 Trueness

A4.1 Estimation of trueness

Trueness is the closeness of agreement between a test result and the accepted reference value of the property being measured. Trueness is stated quantitatively in terms of “bias”; with smaller bias indicating greater trueness. Bias is typically determined by comparing the response of the method to a reference material with the known value assigned to the material. Significance testing is recommended. Where the uncertainty in the reference value is not negligible, evaluation of the results should consider the reference material uncertainty as well as the statistical variability.

A4.2 Conditions for trueness experiments

Bias can arise at different levels of organisation in an analytical system, for example, run bias, laboratory bias and method bias. It is important to remember which of these is being handled by the various methods of addressing bias. In particular:

- The mean of a series of analyses of a reference material, carried out wholly within a single run, gives information about the sum of method, laboratory and run effect for that particular run. Since the run effect is assumed to be random from run to run, the result will vary from run to run more than would be expected from the observable dispersion of the results, and this needs to be taken into account in the evaluation of the results (for example, by testing the measured bias against the among-runs standard deviation investigated separately).
- The mean of repeated analyses of a reference material in several runs, estimates the combined effect of method and laboratory bias in the

**COMPENDIUM OF INTERNATIONAL ANALYSIS OF METHODS -
OIV
Single laboratory validation**

particular laboratory (except where the value is assigned using the particular method).

A4.3 Reference values for trueness experiments

A4.3.1 Certified reference materials (CRMs)

CRMs are traceable to international standards with a known uncertainty and therefore can be used to address all aspects of bias (method, laboratory and within-laboratory) simultaneously, assuming that there is no matrix mismatch. CRMs should accordingly be used in validation of trueness where it is practicable to do so. It is important to ensure that the certified value uncertainties are sufficiently small to permit detection of a bias of important magnitude. Where they are not, the use of CRMs is still recommended, but additional checks should be carried out.

A typical trueness experiment generates a mean response on a reference material. In interpreting the result, the uncertainty associated with the certified value should be taken into account along with the uncertainty arising from statistical variation in the laboratory. The latter term may be based on the within-run, between-run, or an estimate of the between-laboratory standard deviation depending on the intent of the experiment. Statistical or materials. Where the certified value uncertainty is small, a Student's *t* test is normally carried out, using the appropriate precision term.

Where necessary and practicable, a number of suitable CRMs, with appropriate matrices and analyte concentrations, should be examined. Where this is done, and the uncertainties on the certified values are smaller than those on the analytical results, it would be reasonably safe to use simple regression to evaluate the results. In this way bias could be expressed as a function of concentration, and might appear as a non-zero intercept ("transitional" or constant bias) or as a non-unity slope ("rotational" or proportional bias). Due caution should be applied in interpreting the results where the range of matrices is large.

4.3.2 Reference materials

Where CRMs are not available, or as an addition to CRMs, use may be made of any material sufficiently well characterised for the purpose (a reference material¹⁰), bearing in mind always that while insignificant bias may not be proof of zero bias, significant bias on any material remains a cause for investigation. Examples of reference materials include: Materials characterised by a reference material producer, but whose values are not accompanied by an uncertainty statement or are otherwise qualified; materials characterised by a manufacturer of the material;

materials characterised in the laboratory for use as reference materials; materials subjected to a restricted round-robin exercise, or distributed in a proficiency test. While the traceability of these materials may be questionable, it would be far better to use them than to conduct no assessment for bias at all. The materials would be used in much the same way as CRMs, though with no stated uncertainty any significance test relies wholly on the observable precision of results.

A4.3.3 Use of a reference method

A reference method can in principle be used to test for bias in another method under validation. This is a useful option when checking an alternative to, or modification of, an established standard method already validated and in use in the laboratory. Both methods are used to analyse a number of typical test materials, preferably covering a useful range of concentration fairly evenly. Comparison of the results over the range by a suitable statistical method (for example, a paired *t*-test, with due checks for homogeneity of variance and normality) would demonstrate any bias between the methods.

A4.3.4 Use of spiking/recovery

In the absence of reference materials, or to support reference material studies, bias can be investigated by spiking and recovery. A typical test material is analysed by the method under validation both in its original state and after the addition (spiking) of a known mass of the analyte to the test portion. The difference between the two results as a proportion of the mass added is called the surrogate recovery or sometimes the marginal recovery. Recoveries significantly different from unity indicate that a bias is affecting the method. Strictly, recovery studies as described here only assess bias due to effects operating on the added analyte; the same effects do not necessarily apply to the same extent to the native analyte, and additional effects may apply to the native analyte. Spiking/recovery studies are accordingly very strongly subject to the observation that while good recovery is not a guarantee of trueness, poor recovery is certainly an indication of lack of trueness. Methods of handling spiking/recovery data have been covered in detail elsewhere.⁴

A5 Precision

Precision is the closeness of agreement between independent test results obtained under stipulated conditions. It is usually specified in terms of standard deviation or relative standard deviation. The distinction between precision and bias is fundamental, but depends on the level at which the analytical system is viewed.

Thus from the viewpoint of a single determination, any deviation affecting the calibration for the run would be seen as a bias. From the point of view of the analyst reviewing a year's work, the run bias will be different every day and act like a random variable with an associated precision. The stipulated conditions for the estimation of precision take account of this change in view point.

For single laboratory validation, two sets of conditions are relevant: (a) precision under repeatability conditions, describing variations observed during a single run as expectation 0 and standard deviation ζ_r , and (b) precision under run-to-run conditions, describing variations in run bias δ_{run} as expectation 0, standard deviation ζ_{run} . Usually both of these sources of error are operating on individual analytical results, which therefore have a combined precision $\sigma_{tot} = (\sigma_r^2/n + \sigma_{run}^2)^{1/2}$, where n is the number of repeat results averaged within a run for the reported result. The two precision estimates can be obtained most simply by analysing the selected test material in duplicate in a number of successive runs. The separate variance components can then be calculated by the application of one-way analysis of variance. Each duplicate analysis must be an independent execution of the procedure applied to a separate test portion. Alternatively the combined precision ζ_{tot} can be estimated directly by the analysis of the test material once in successive runs, and estimating the standard deviation from the usual equation. (Note that observed standard deviations are generally given the symbol s , to distinguish them from standard deviations σ).

It is important that the precision values are representative of likely test conditions. First, the variation in conditions among the runs must represent what would normally happen in the laboratory under routine use of the method. For instance, variations in reagent batches, analysts and instruments should be representative. Second, the test material used should be typical, in terms of matrix and (ideally) the state of comminution, of the materials likely to encountered in routine application. So actual test materials or, to a lesser degree, matrix-matched reference materials would be suitable, but standard solutions of the analyte would not. Note also that CRMs and prepared reference materials are frequently homogenised to a greater extent than typical test materials, and precision obtained from their analysis may accordingly under-estimate the variation that will be observed for test materials.

Precision very often varies with analyte concentration. Typical assumptions are i) that there is no change in precision with analyte level, or ii) that the standard deviation is proportional to, or linearly dependent on, analyte level. In both cases, the assumption needs to be checked if the analyte level is expected to vary

substantially (that is, by more than about 30% from its central value). The most economical experiment is likely to be a simple assessment of precision at or near the extremes of the operating range, together with a suitable statistical test for difference in variance. The F-test is appropriate for normally distributed error.

Precision data may be obtained for a wide variety of different sets of conditions in addition to the minimum of repeatability and between-run conditions indicated here, and it may be appropriate to acquire additional information. For example, it may be useful to the assessment of results, or for improving the measurement, to have an indication of separate operator and run effects, between or within-day effects or the precision attainable using one or several instruments. A range of different designs and statistical analysis techniques is available, and careful experimental design is strongly recommended in all such studies.

A6 Recovery

Methods for estimating recovery are discussed in conjunction with methods of estimating trueness (above).

A7 Range

The validated range is the interval of analyte concentration within which the method can be regarded as validated. It is important to realise that this range is not necessarily identical to the useful range of the calibration. While the calibration may cover a wide concentration range, the remainder of the validation (and usually much more important part in terms of uncertainty) will cover a more restricted range. In practice, most methods will be validated at only one or two levels of concentration. The validated range may be taken as a reasonable extrapolation from these points on the concentration scale.

When the use of the method focuses on a concentration of interest well above the detection limit, validation near that one critical level would be appropriate. It is impossible to define a general safe extrapolation of this result to other concentrations of the analyte, because much depends on the individual analytical system. Therefore the validation study report should state the range around the critical value in which the person carrying out the validation, using professional judgement, regards the estimated uncertainty to hold true.

When the concentration range of interest approaches zero, or the detection limit, it is incorrect to assume either constant absolute uncertainty or constant relative uncertainty. A useful approximation in this common circumstance is to assume a

linear functional relationship, with a positive intercept, between uncertainty u and concentration c , that is of the form

$$u(c) = u_0 + \theta c$$

where T is the relative uncertainty estimated at some concentration well above the detection limit. u_0 is the standard uncertainty estimated for zero concentration and in some circumstances could be estimated as $c_L / 3$. In these circumstances it would be reasonable to regard the validated range as extending from zero to a small integer multiple of the upper validation point. Again this would depend on professional judgement.

A8 Detection Limit

In broad terms the detection limit (limit of detection) is the smallest amount or concentration of analyte in the test sample that can be reliably distinguished from zero.^{22,23} For analytical systems where the validation range does not include or approach it, the detection limit does not need to be part of a validation.

Despite the apparent simplicity of the idea, the whole subject of the detection limit is beset with problems outlined below:

- There are several possible conceptual approaches to the subject, each providing a somewhat different definition of the limit. Attempts to clarify the issue seem ever more confusing.
- Although each of these approaches depends on an estimate of precision at or near zero concentration, it is not clear whether this should be taken as implying repeatability conditions or some other condition for the estimation.
- Unless an inordinate amount of data is collected, estimates of detection limit will be subject to quite large random variation.
- Estimates of detection limit are often biased on the low side because of operational factors.
- Statistical inferences relating to the detection limit depend on the assumption of normality, which is at least questionable at low concentrations.

For most practical purposes in method validation, it seems better to opt for a simple definition, leading to a quickly implemented estimation which is used only

as a rough guide to the utility of the method. However, it must be recognised that the detection limit as estimated in method development, may not be identical in concept or numerical value to one used to characterise a complete analytical method. For instance the “instrumental detection limit”, as quoted in the literature or in instrument brochures and then adjusted for dilution, is often far smaller than a “practical” detection limit and inappropriate for method validation.

It is accordingly recommended that for method validation, the precision estimate used ($\hat{\sigma}_0$) should be based on at least 6 independent complete determinations of analyte concentration in a typical matrix blank or low-level material, with no censoring of zero or negative results, and the approximate detection limit calculated as $3\hat{\sigma}_0$. Note that with the recommended minimum number of degrees of freedom, this value is quite uncertain, and may easily be in error by a factor of two. Where more rigorous estimates are required (for example to support decisions based on detection or otherwise of a material), reference should be made to appropriate guidance (see, for example, references 22.-23.).

A9 Limit of determination or limit of quantification

It is sometimes useful to state a concentration below which the analytical method cannot operate with an acceptable precision. Sometimes that precision is arbitrarily defined as 10% RSD, sometimes the limit is equally arbitrarily taken as a fixed multiple (typically 2) of the detection limit. While it is to a degree reassuring to operate above such a limit, we must recognise that it is a quite artificial dichotomy of the concentration scale: measurements below such a limit are not devoid of information content and may well be fit for purpose. Hence the use of this type of limit in validation is not recommended here. It is preferable to try to express the uncertainty of measurement as a function of concentration and compare that function with a criterion of fitness for purpose agreed between the laboratory and the client or end-user of the data.

A10 Sensitivity

The sensitivity of a method is the gradient of the calibration function. As this is usually arbitrary, depending on instrumental settings, it is not useful in validation. (It may be useful in quality assurance procedures, however, to test whether an instrument is performing to a consistent and satisfactory standard.)

A11 Ruggedness

The ruggedness of an analytical method is the resistance to change in the results produced by an analytical method when minor deviations are made from the experimental conditions described in the procedure. The limits for experimental parameters should be prescribed in the method protocol (although this has not always been done in the past), and such permissible deviations, separately or in any combination, should produce no meaningful change in the results produced. (A “meaningful change” here would imply that the method could not operate within the agreed limits of uncertainty defining fitness for purpose.) The aspects of the method which are likely to affect results should be identified, and their influence on method performance evaluated by using ruggedness tests.

The ruggedness of a method is tested by deliberately introducing small changes to the procedure and examining the effect on the results. A number of aspects of the method may need to be considered, but because most of these will have a negligible effect it will normally be possible to vary several at once. An economical experiment based on fractional factorial designs has been described by Youden¹³. For instance, it is possible to formulate an approach utilising 8 combinations of 7 variable factors, that is to look at the effects of seven parameters with just eight analytical results. Univariate approaches are also feasible, where only one variable at a time is changed.

Examples of the factors that a ruggedness test could address are: changes in the instrument, operator, or brand of reagent; concentration of a reagent; pH of a solution; temperature of a reaction; time allowed for completion of a process etc.

A12 Fitness for Purpose

Fitness for purpose is the extent to which the performance of a method matches the criteria, agreed between the analyst and the end-user of the data, that describe the end-user’s needs. For instance the errors in data should not be of a magnitude that would give rise to incorrect decisions more often than a defined small probability, but they should not be so small that the end-user is involved in unnecessary expenditure. Fitness for purpose criteria could be based on some of the characteristics described in this Annex, but ultimately will be expressed in terms of acceptable total uncertainty.

A13 Matrix variation

Matrix variation is, in many sectors, one of the most important but least acknowledged sources of error in analytical measurements. When we define the analytical system to be validated by specifying, amongst other things, the matrix of

the test material, there may be scope for considerable variation within the defined class. To cite an extreme example, a sample of the class “soil” could be composed of clay, sand, chalk, laterite (mainly Fe₂O₃ and Al₂O₃), peat, etc., or of mixtures of these. It is easy to imagine that each of these types would contribute a unique matrix effect on an analytical method such as atomic absorption spectrometry. If we have no information about the type of soils we are analysing, there will be an extra uncertainty in the results because of this variable matrix effect.

Matrix variation uncertainties need to be quantified separately, because they are not taken into account elsewhere in the process of validation. The information is acquired by collecting a representative set of the matrices likely to be encountered within the defined class, all with analyte concentrations in the appropriate range. The material are analysed according to the protocol, and the bias in the results estimated. Unless the test materials are CRMs, the bias estimate will usually have to be undertaken by means of spiking and recovery estimation. The uncertainty is estimated by the standard deviation of the biases. (Note: This estimate will also contain a variance contribution from the repeat analysis. This will have a magnitude $2\zeta_r^2$ if spiking has been used. If a strict uncertainty budget is required, this term should be deducted from the matrix variation variance to avoid double accounting.)

A14 Measurement Uncertainty

The formal approach to measurement uncertainty estimation calculates a measurement uncertainty estimate from an equation, or mathematical model. The procedures described as method validation are designed to ensure that the equation used to estimate the result, with due allowance for random errors of all kinds, is a valid expression embodying all recognised and significant effects upon the result. It follows that, with one caveat elaborated further below, the equation or ‘model’ subjected to validation may be used directly to estimate measurement uncertainty. This is done by following established principles, based on the ‘law of propagation of uncertainty’ which, for independent input effects is

$$u(y(x_1, x_2, \dots)) = \sqrt{\sum_{i=1, n} c_i^2 u(x_i)^2}$$

where $y(x_1, x_2, \dots, x_n)$ is a function of several independent variables x_1, x_2, \dots , and c_i is a sensitivity coefficient evaluated as $c_i = \partial y / \partial x_i$, the partial differential of y with respect to x_i . $u(x_i)$ and $u(y)$ are *standard uncertainties*, that is, measurement uncertainties expressed in the form of standard deviations. Since $u(y(x_1, x_2, \dots))$ is a

function of several separate uncertainty estimates, it is referred to as a *combined standard uncertainty*.

To estimate measurement uncertainty from the equation $y=f(x_1, x_2, \dots)$ used to calculate the result, therefore, it is necessary first, to establish the uncertainties $u(x_i)$ in each of the terms x_1, x_2 etc. and second, to combine these with the additional terms required to represent random effects as found in validation, and finally to take into account any additional effects. In the discussion of precision above, the implied statistical model is

$$y=f(x_1, x_2, \dots) + \delta_{\text{run}} + e$$

where e is the random error for a particular result. Since δ_{run} and e are known, from the precision experiments, to have standard deviations ζ_{run} and ζ_r respectively, these latter terms (or, strictly, their estimates s_{run} and s_r) are the uncertainties associated with these additional terms. Where the individual within-run results are averaged, the combined uncertainty associated with these two terms is (as given previously) $s_{\text{tot}} = \left(s_r^2/n + s_{\text{run}}^2 \right)^{1/2}$. Note that where the precision terms are shown to vary with analyte level, the uncertainty estimate for a given result must employ the precision term appropriate to that level. The basis for the uncertainty estimate accordingly follows directly from the statistical model assumed and tested in validation. To this estimate must be added any further terms as necessary to account for (in particular) inhomogeneity and matrix effect (see section A13). Finally, the calculated standard uncertainty is multiplied by a ‘coverage factor’, k , to provide an expanded uncertainty, that is, “an interval expected to encompass a large fraction of the distribution of values that may be attributed to the measurand”⁸. Where the statistical model is well established, the distribution known to be normal, and the number of degrees of freedom associated with the estimate is high, k is generally chosen to be equal to 2. The expanded uncertainty then corresponds approximately to a 95% confidence interval.

There is one important caveat to be added here. In testing the assumed statistical model, imperfect tests are perforce used. It has already been noted that these tests can not prove that any effect is identically zero; they can only show that an effect is too small to detect within the uncertainty associated with the particular test for significance. A particularly important example is the test for significant laboratory bias. Clearly, if this is the only test performed to confirm trueness, there must be some residual uncertainty as to whether the method is indeed unbiased or not. It follows that where such uncertainties are significant with respect to the uncertainty calculated so far, additional allowance should be made.

In the case of an uncertain reference value, the simplest allowance is the stated uncertainty for the material, combined with the statistical uncertainty in the test applied. A full discussion is beyond the scope of this text; reference 9. provides further detail. It is, however, important to note that while the uncertainty estimated directly from the assumed statistical model is the *minimum* uncertainty that can be associated with an analytical result, it will almost certainly be an underestimate; similarly, an expanded uncertainty based on the same considerations and using $k=2$ will not provide sufficient confidence.

The ISO Guide⁸ recommends that for increased confidence, rather than arbitrarily adding terms, the value of k should be increased as required. Practical experience suggests that for uncertainty estimates based on a validated statistical model, but with no evidence beyond the validation studies to provide additional confidence in the model, k should not be less than 3. Where there is strong reason to doubt that the validation study is comprehensive, k should be increased further as required.

**ANNEX B. Additional considerations for UNCERTAINTY
ESTIMATION IN VALIDATION STUDIES**

B1 Sensitivity analysis

The basic expression used in uncertainty estimation

$$u(y(x_1, x_2, \dots)) = \sqrt{\sum_{i=1, n} c_i^2 u(x_i)^2}$$

requires the ‘sensitivity coefficients’ c_i . It is common in uncertainty estimation to find that while a given influence factor x_i has a known uncertainty $u(x_i)$, the coefficient c_i is insufficiently characterised or not readily obtainable from the equation for the result. This is particularly common where an effect is not included in the measurement equation because it is not normally significant, or because the relationship is not sufficiently understood to justify a correction. For example, the effect of solution temperature T_{sol} on a room temperature extraction procedure is rarely established in detail.

Where it is desired to assess the uncertainty in a result associated with such an effect, it is possible to determine the coefficient experimentally. This is done most simply by changing x_i and observing the effect on the result, in a manner very similar to basic ruggedness tests. In most cases, it is sufficient in the first instance to choose at most two values of x_i other than the nominal value, and calculate an approximate gradient from the observed results. The gradient then gives an approximate value for c_i . The term $c_i u(x_i)$ can then be determined. (Note that this is one practical method for demonstrating the significance or otherwise of a possible effect on the results).

In such an experiment, it is important that the change in result observed be sufficient for a reliable calculation of c_i . This is difficult to predict in advance. However, given a permitted range for the influence quantity x_i , or an expanded uncertainty for the quantity, that is expected to result in insignificant change, it is clearly important to assess c_i from a larger range. It is accordingly recommended that for an influence quantity with an expected range of $\pm a$, (where $\pm a$ might be, for example, the permitted range, expanded uncertainty interval or 95% confidence interval) the sensitivity experiment employ, where possible, a change of at least $4a$ to ensure reliable results.

B2 Judgement

It is not uncommon to find that while an effect is recognised and may be significant, it is not always possible to obtain a reliable estimate of uncertainty. In such circumstances, the ISO Guide makes it quite clear that a professionally considered estimate of the uncertainty is to be preferred to neglect of the uncertainty. Thus, where no estimate of uncertainty is available for a potentially important effect, the analyst should make their own best judgement of the likely uncertainty and apply that in estimating the combined uncertainty. Reference 8. gives further guidance on the use of judgement in uncertainty estimation.

Recommendations on measurement uncertainty
(Resolution OENO 9/2005)

INTRODUCTION

It is important that analysts are aware of the uncertainty associated with each analytical result and estimates of uncertainty. The measurement uncertainty may be derived by a number of procedures. Food analysis laboratories are required to be in control, use collaboratively tested methods when available, and verify their application before taking them into routine use. Such laboratories therefore have available to them a range of analytical data which can be used to estimate their measurement uncertainty.

Terminology

The accepted definition for Measurement Uncertainty¹ is:

“Parameter, associated with the result of a measurement, that characterises the dispersion of the values that could reasonably be attributed to the measurand.

NOTES:

1. The parameter may be, for example, a standard deviation (or a given multiple of it), or the half-width of an interval having a stated level of confidence.
2. Uncertainty of measurement comprises, in general, many components. Some of these components may be evaluated from the statistical distribution of results of a series of measurements and can be characterised by experimental standard deviations. The other components, which can also be characterised by standard deviations, are evaluated from assumed probability distributions based on experience or other information.
3. It is understood that the result of a measurement is the best estimate of the value of a measurand, and that all components of uncertainty, including those arising from systematic effects. Such as components associated with corrections and reference standards, contribute to the dispersion.”

[It is recognised that the term “measurement uncertainty” is the most widely used term by International Organisations and Accreditation Agencies. However The Codex ALIMENTARIUS Committee on Methods of Analysis and Sampling has

**COMPENDIUM OF INTERNATIONAL ANALYSIS OF METHODS -
OIV**

Recommendations on measurement uncertainty

commented on a number of occasions that the term “Measurement Uncertainty” has some negative associations in legal context and so has noted that an alternative, equivalent, term, “measurement reliability”, may be used.]

Recommendations

The following recommendations are made to governments:

1. For OIV purposes the term “measurement uncertainty” or “measurement reliability” shall be used.
2. The measurement uncertainty or “measurement reliability” associated with all analytical results is to be estimated and must, on request be made available to the user (customer) of the results.
3. The measurement uncertainty or “measurement reliability” of an analytical result may be estimated in a number of procedures notably those described by ISO¹ and EURACHEM². These documents recommend procedures based on a component-by-component approach, method validation data, internal quality control data and proficiency test data. The need to undertake an estimation of the measurement uncertainty or “Measurement reliability” using the ISO component-by-component approach is not necessary if the other forms of data are available and used to estimate the uncertainty or reliability. In many cases the overall uncertainty may be determined by an inter-laboratory (collaborative) study by a number of laboratories and a number of matrices by the IUPAC/ISO/AOAC INTERNATIONAL³ or by the ISO 5725 Protocols⁴.

**COMPENDIUM OF INTERNATIONAL ANALYSIS OF METHODS -
OIV
Recommendations on measurement uncertainty**

REFERENCES

1. “Guide to the Expression of Uncertainty in Measurement”, ISO, Geneva, 1993.
2. EURACHEM/CITAC Guide Quantifying Uncertainty In Analytical Measurement (Second Edition), EURACHEM Secretariat, HAM, Berlin, 2000. This is available as a free download from <http://www.vtt.fi/ket/eurachem>.
3. “Protocol for the Design, Conduct and Interpretation of Method Performance Studies”, ed. W. Horwitz, Pure Appl. Chem., 1995, 67, 331-343.
4. “Precision of Test Methods”, Geneva, 1994, ISO 5725, Previous editions were published in 1981 and 1986.

Recommendations related to the recovery correction
(Resolution OIV/OENO 392/2009)

Recovery

“The OIV recommends the following practice with regards to reporting recovery of analytical results.

- Analytical results are to be expressed on a recovery corrected basis where appropriate and relevant, and when corrected it has to be stated.
- If a result has been corrected for recovery, the method by which the recovery was taken into account should be stated. The recovery rate is to be quoted wherever possible.
- When laying down provisions for standards, it will be necessary to state whether the result obtained by a method used for analysis within conformity checks shall be expressed on a recovery-corrected basis or not.”

Annex F

Specific methods for the analysis of grape sugar¹ (rectified concentrated musts)

¹ Grape sugar are defined in Part I-6.2 and in Part II-2.1.12 of the International Code of Oenological Practices of the OIV.

Specifications of grape sugar are described in file COEI-1-SUCRAI of International Oenological Codex of the OIV.

Method OIV-MA-F1-01

Type IV method

Conductivity

OIV-OENO 419A-2011

1. Principle

The electrical conductivity of a column of liquid defined by two parallel platinum electrodes at its ends is measured by incorporating it in one arm of a Wheatstone bridge.

The conductivity varies with temperature and it is therefore expressed at 20°C.

2. Reagents

Use only reagent grade chemicals

2.1 Purified water for laboratories, with specific conductivity below 2 $\mu\text{S cm}^{-1}$ at 20°C, for example EN ISO 3696 type II water.

2.2 Reference solution of potassium chloride.

Dissolve 0.581 g of potassium chloride, KCl previously dried to constant mass at a temperature of 105°C, in demineralised water (2.1).

Make up to one litre with demineralised water (2.1). This solution has a conductivity of 1 000 $\mu\text{S cm}^{-1}$ at 20°C. It should not be kept for more than three months.

A commercial preparation can be used.

3. Apparatus

3.1 Conductivity meter enabling measurements of conductivity to be made over a range from 1 to 1 000 microsiemens per cm ($\mu\text{S cm}^{-1}$).

3.2 Water bath for bringing the temperature of samples to be analysed to approximately 20°C ($20 \pm 2^\circ\text{C}$).

4. Procedure**4.1 Preparation of the sample to be analysed**

Use a solution with a total sugar concentration of 25 ± 0.5 % (m/m) (25° Brix): weigh a mass equal to $2500/P$ and make up to 100 g with water (2.1),

P = percentage (m/m) of total sugars in the rectified concentrated must.

4.2 Determination of conductivity

Bring the sample to be analysed to 20°C by immersion in a water bath.

Maintain the temperature to within ± 0.1 °C.

Rinse the conductivity cell twice with the solution to be examined.

Measure the conductivity and express the result in $\mu\text{S cm}^{-1}$.

5. Expression of the Results

The result is expressed in microsiemens per cm (μScm^{-1}) at 20°C to the nearest whole number for the 25% (m/m) (25° Brix) solution of rectified concentrated must.

5.1 Calculations

If the apparatus does not have temperature compensation, correct the measured conductivity using Table I. If the temperature is below 20°C, add the correction; if the temperature is above 20°C, subtract the correction.

6. Characteristics of the method

Repeatability (r)

$$r = 3 \mu\text{S/cm}$$

Reproducibility (R)

$$R = 16 \mu\text{S/cm}$$

COMPENDIUM OF INTERNATIONAL ANALYSIS OF METHODS - OIV**Conductivity**

TABLE I

Corrections to be made to the conductivity for temperatures different from 20°C ($\mu\text{S cm}^{-1}$)

Conductivity	Temperature (°C)									
	20.2 19.8	20.4 19.6	20.6 19.4	20.8 19.2	21.0 19.0	21.2 18.8	21.4 18.6	21.6 18.4	21.8 18.2	22.0 ⁽¹⁾ 18.0 ⁽²⁾
0	0	0	0	0	0	0	0	0	0	0
50	0	0	1	1	1	1	1	2	2	2
100	0	1	1	2	2	3	3	3	4	4
150	1	1	2	3	3	4	5	5	6	7
200	1	2	3	3	4	5	6	7	8	9
250	1	2	3	4	6	7	8	9	10	11
300	1	3	4	5	7	8	9	11	12	13
350	1	3	5	6	8	9	11	12	14	15
400	2	3	5	7	9	11	12	14	16	18
450	2	3	6	8	10	12	14	16	18	20
500	2	4	7	9	11	13	15	18	20	22
550	2	5	7	10	12	14	17	19	22	24
600	3	5	8	11	13	16	18	21	24	26

⁽¹⁾Subtract the correction.⁽²⁾Add the correction.

Method OIV-MA-F1-02

Type IV method

**Hydroxymethylfurfural (HMF) by High-Performance Liquid
Chromatography**
OIV-OENO 419A-2011

1. Principle of the Method

High-performance liquid chromatography (HPLC)

Separation through a column by reversed-phase chromatography and determination at 280 nm.

2. Reagents

2.1 Purified water for laboratory use and of quality standard EN ISO 3696

2.2 Methanol, CH₃OH, distilled or HPLC quality. – CAS Number 67-59-1

2.3 Acetic acid, CH₃COOH, ($\rho_{20} = 1.05$ g/ml). – CAS Number 64-19-7

2.4 Mobile phase: water (2.1) -methanol (2.2)-acetic acid (2.3) previously filtered through a membrane filter (0.45 μ m), (40:9:1 v/v).

This mobile phase must be prepared daily and degassed before use.

2.5 Reference solution of hydroxymethylfurfural, 25 mg/l (m/v).

Into a 100 ml volumetric flask, place 25 mg of hydroxymethylfurfural, C₆H₃O₆, accurately weighed, and make up to the mark with methanol (2.2). Dilute this solution 1/10 with methanol (2.2) and filter through a membrane filter (0.45 μ m).

If kept in a hermetically sealed brown glass bottle in a refrigerator, this solution will keep for two to three months.

(The concentration of the reference solution is given for guidance)

3. Equipment

3.1 Apparatus

3.1.1 High-performance liquid chromatograph equipped with:

- a loop injector, 5 or 10 μ l, (as an example),
 - spectrophotometric detector for making measurements at 280 nm,
 - column of octadecyl-bonded silica (e.g.: *Bondapak C18* — *Corasil*, *Waters Ass.*),
 - a recorder and, if required, an integrator,
- Flow rate of mobile phase: 1.5 ml/minute (as an example).

3.1.2 Membrane filtration apparatus, pore diameter 0.45 µm.

4. Procedure

4.1 Preparation of sample

Use the solution obtained by diluting the rectified concentrated must to 40% (m/v) (introduce 200 g of accurately weighed rectified concentrated must into a 500 ml volumetric flask. Make up to the mark with water and homogenise) and filter it through a membrane filter (0.45 µm).

4.2 Chromatographic determination

Inject 5 (or 10) µl of the sample prepared as described in paragraph 4.1. and 5 (or 10) µl of the reference hydroxymethylfurfural solution (2.5) into the chromatograph. Record the chromatogram.

The retention time of hydroxymethylfurfural is approximately six to seven minutes.

The volume injected and the sequence are given for guidance. The chromatographic determination can also be done with a calibration curve

5. Expression of results

The hydroxymethylfurfural concentration in rectified concentrated musts is expressed in milligrams per kilogram of total sugars.

5.1 Method of calculation

Let the hydroxymethylfurfural concentration in the 40% (m/v) solution of the rectified concentrated must be *C* mg/l.

The hydroxymethylfurfural concentration in milligrams per kilogram of total sugars is given by:

$$250 \times C/P$$

P = percentage (m/m) concentration of total sugars in the rectified concentrated must.

6. Characteristics of the method

Repeatability (*r*)

$$r = 0.5 \text{ mg/kg total sugars}$$

Reproducibility (*R*)

$$R = 3.0 \text{ mg/kg total sugars}$$

Method OIV-MA-F1-03

Type IV method

**Determination of the acquired alcoholic strength by volume
(ASV) of concentrated musts (CM) and grape sugar (or
rectified concentrated musts, RCM)**

OIV-OENO 419A-2011

1. Introduction

Concentrated musts (CM) and grape sugar (RCM) are viscous products with low alcohol contents; to determine their acquired ASV, a method must be used, the characteristics of which (linearity, repeatability, reproducibility, specificity, and detection and quantification limits) must be such that it is possible to measure alcohol contents of less than 1% vol.

2. Field of application

The method applies to concentrated musts and grape sugar.

3. Principle

A known mass of concentrated must (CM) or grape sugar is made alkaline by a suspension of calcium hydroxide and then distilled. The alcoholic strength by volume of the distillate is determined by electronic densitometry or by densitometry using a hydrostatic balance.

4. Reagents

- Suspension of 2M calcium hydroxide of analytical quality obtained by carefully pouring one litre of hot water (60°C to 70°C) on to about 120 g of unslaked lime (CaO).
- Antifoam solution obtained by dilution of 2 ml of concentrated silicone antifoam in 100 ml of water.
- Purified water for laboratory use and of quality EN ISO 3696.

5. Equipment

- Standard laboratory equipment including volumetric flasks
- Analytic balance capable of weighing to within 0.1 g.
- Any type of distillation or steam distillation apparatus may be used provided that it satisfies the following test:
Distil an ethanol-water mixture with an alcoholic strength of 10% vol. five times in succession. The distillate should have an alcoholic strength of at least 9.9% vol. after the fifth distillation; i.e. the loss of alcohol during each distillation should not be more than 0.02% vol.
- Electronic density meter or hydrostatic balance.

6. Procedure

- Homogenise the test sample by inverting the flask several times.
- In a 500 ml volumetric flask, weigh about 200 g of concentrated must or rectified concentrated must (to within 0.1 g). Note the weight (TS) of this test sample. Fill up to the mark with deionised water. This solution is about 40% m/v in must.

Obtaining the distillate

- Transfer 250 ml of the 40% solution to the distillation flask, add to the flask about 10 ml of calcium hydroxide in suspension, about 5 ml of antifoam solution and, where applicable, a boiling regulator (e.g. pieces of porcelain).
- Gently bring to the boil.
- Recover the distillate in a 100 ml volumetric flask (about 90 ml).
- Leave the distillate to return to ambient temperature, then fill up to the mark with deionised water.

Measurement of ASV

This is performed by electronic densitometry or by hydrostatic balance.

7. Calculation

$$\text{Acquired alcoholic strength by volume} = \frac{\text{ASV measured} \times 200 \times \text{MV}}{\text{TS}}$$

ASV measured = alcohol content given by the density meter, as % vol.

TS = test sample of concentrated must or grape sugar, in weight.

MV = density of concentrated must or rectified concentrated must, in g/ml

The results are expressed to 2 decimal places and rounded to within 0.05 %vol.

8. Characteristics of the method

8.1 Linearity of response

The linearity of the density meter for low ASV values is one of the critical parameters of this method. A standard range of 10 aqueous-alcoholic solutions of ASV ranging between 0 and 5%vol. was prepared. Each solution was analysed 3 times.

The response of the density meter is perfectly linear within this range as shown by the calibration line in Figure 1.

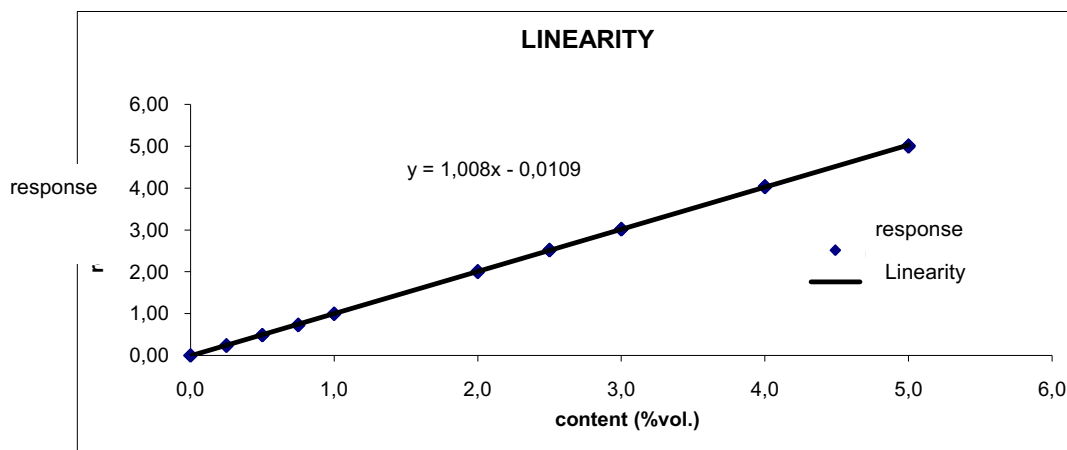

Figure 1: Linearity of determination of the ASV by electronic densitometry between 0 and 5%vol.

8.2 Specificity of the method

The second critical point of this method is the distillation of viscous musts containing small quantities of alcohol. In order to verify the specificity, known quantities of ethanol (from 0.25% vol to 5% vol) were added to CMs and grape sugar. The supplemented test specimens were distilled in the conditions defined earlier, then the distillates were analysed by electronic densitometry or by **hydrostatic balance**.

The results are shown in Table 1. The recovery rate is satisfactory, ranging between 88% and 99%. As shown by the line in Figure 2, the method is specific (slope in the vicinity of 1, intercept point in the vicinity of 0).

**COMPENDIUM OF INTERNATIONAL ANALYSIS OF METHODS - OIV
Alcoholic strength by volume (ASV)**

Table 1: Recovery rate for determination of the acquired ASV of CMs and Grape Sugar

Test specimen	Initial content (%vol.)	Added content (%vol.)	Recovered content (%vol.)	Recovery rate (%)
CM 1	0.00	0.25	0.22	88
CM 1	0.00	1.00	0.98	98
Grape Sugar (RCM) 1	0.00	1.00	0.94	94
Grape Sugar (RCM) 1	0.00	2.00	1.97	99
CM 2	0.00	0.50	0.44	88
Grape Sugar (RCM)2	0.00	5.00	4.94	99

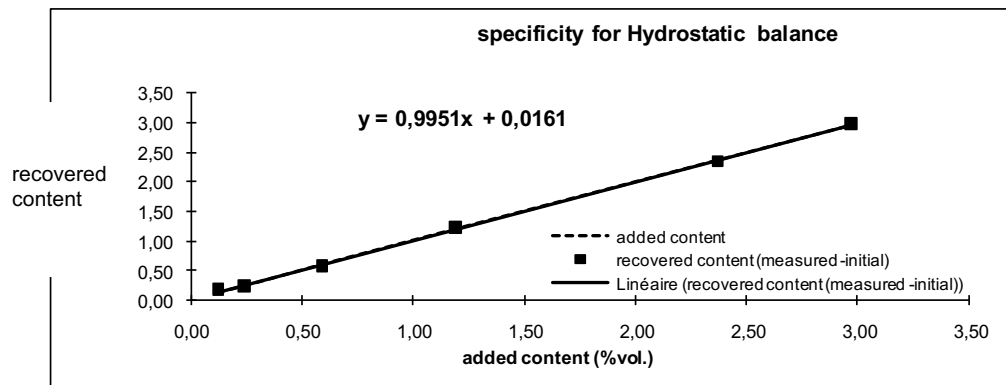
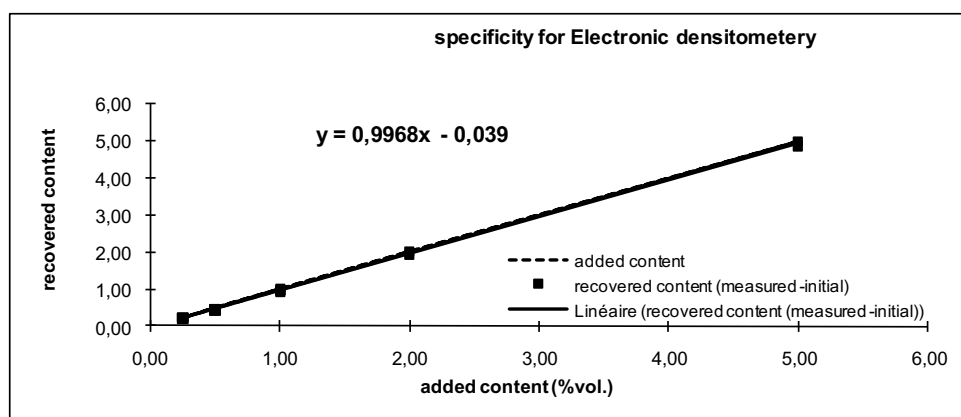

Figure 2: Specificity of determination of the acquired ASV of CMs and Grape Sugar

8.3 Repeatability

The repeatability of the method was determined using 20 test specimens of CM or grape sugar supplemented with alcohol or not. Each CM or RCM test specimen was analysed 3 times, in order to ensure identical conditions. The repeatability limits obtained are as follows:

Table 2: Repeatability of determination of the acquired ASV of CMs and Grape Sugar

Repeatability for electronic densitometry	Calculated value
Standard deviation	0.009
CV or RSD as %	0.9%
r limit	0.024 %vol.
r limit as %	3%
Repeatability for Hydrostatic balance	Calculated value
Standard deviation	0.013
CV or RSD as %	1.7%
r limit	0.038 %vol.
r limit as %	5,3%

8.4 Reproducibility

The reproducibility of the results is determined by analysing the same must twice, at different dates during a given period of time. The results are given in Table 3.

Table 3 - Reproducibility of determination of the acquired ASV of CMs and grape sugar

Reproducibility for electronic densitometry	Calculated value
Standard deviation	0.043
CV or RSD as %	3%
R limit	0.12%vol.
R limit as %	9%
Reproducibility for Hydrostatic balance	Calculated value
Standard deviation	0.026
CV or RSD as %	3.4%
R limit	0.076%vol.
R limit as %	10.6%

8.5 Detection and quantification limits

The limits of detection (LD) and quantification (LQ) estimated based on the linearity study are as follows:

$$\mathbf{LD = 0.01\%vol. \quad LQ = 0.05\%vol.}$$

The quantification limit was verified by analysis of musts having an ASV at a concentration level of 0.05%vol.

8.6 Uncertainty

Uncertainty, evaluated based on the reproducibility standard deviation, is 0.10%vol.

Method OIV-MA-F1-04

Type IV method

Sucrose by High-Performance Liquid Chromatography

OIV-OENO 419A-2011

1. Principle

For testing and determination by high-performance liquid chromatography: the sucrose is separated in a column of alkylamine-bonded silica and detected by refractometry. The result is quantified by reference to an external standard analysed under the same conditions.

Note: Authentication of a must or of a wine may be checked by the method using NMR of deuterium described for detecting the enrichment of musts, rectified concentrated musts and wines.

The chromatographic conditions are given for guidance.

2. Reagents

2.1 Purified water for laboratory use and of quality EN ISO 3696..

2.2 HPLC quality acetonitrile (CH₃ CN) – CAS Number 75-05-8

2.3 Sucrose – CAS Number 57-50-1

2.4 Mobile phase: acetonitrile-water (80:20 v/v)., previously subjected to membrane filtration (0.45 µm); the composition of the mobile phase is given as an example.

This mobile phase must be degassed before being used.

2.5 Standard solution: 1.2 g/l aqueous sucrose solution. Filter using a 0.45 µm membrane filter. (The concentration of the standard solution is given as an example.)

3. Equipment

3.1 High-performance liquid chromatograph equipped with:

- 1) 10 µl loop injector (as an example)
- 2) a detector: a differential refractometer or an interferometer refractometer
- 3) an alkylamine-bonded silica column, length 25 cm, internal diameter 4 mm (as an example)
- 4) a guard column filled with the same phase (as an example)
- 5) an arrangement for insulating the guard column and analytical columns or for maintaining their temperature (30 ° C),
- 6) a recorder and, if required, an integrator,

7) mobile phase flow rate: 1 ml/min (as an example).

3.2 Equipment for membrane filtration (0.45 µm).

4. Procedure

4.1 Preparation of sample:

Use the solution obtained by diluting the rectified concentrated must to 40 % (m/v) as described in Annex H 'Total acidity', section 5.1., and filtering it using a 0.45 µm membrane filter.

4.2 Chromatographic determination

Inject in turn into the chromatograph 10 µl of the standard solution and 10 µl of the sample prepared as described in 4.1.

Repeat these injections in the same order.

Record the chromatogram.

The retention time of the sucrose is approximately 10 minutes.

The sample volume and sequence are given for guidance. The chromatographic determination can also be done with a calibration curve

5. Calculations

For the calculation, use the average of two results for the standard solution and the sample.

Let C be the sucrose concentration in g/l of the 40 % (m/v) solution of rectified concentrated must.

The sucrose concentration in g/kg of the rectified concentrated must is then:

$$2.5 \times C$$

6. Expression of results

The sucrose concentration is expressed in grams per kilogram, to one decimal place.

7. Characteristics of the method

Repeatability (r)

$$r = 1.1 \text{ g/kg must}$$

COMPENDIUM OF INTERNATIONAL ANALYSIS OF METHODS - OIV
Total acidity

Method OIV-MA-F1-05

Type IV method

Total acidity
OIV-OENO 419A-2011

1. Definition

The total acidity of the rectified concentrated must is the sum of its titrable acidities when it is titrated to pH 7 against a standard alkaline solution. Carbon dioxide is not included in the total acidity.

2. Principle of the method

2.1 Potentiometric titration or titration with bromothymol blue as an indicator and comparison with an end-point colour standard.

3. Reagents

3.1 Buffer solutions

3.1.1 pH 7.0:

monopotassium phosphate, (KH₂PO₄) : 107.3 g
1 M sodium hydroxide (NaOH) solution: 500 ml
water to: 1 000 ml

3.1.2 pH 4.0

Solution of potassium hydrogen phthalate, 0.05 M, containing 10.211 g of potassium hydrogen phthalate (C₈H₅KO₄) per litre at 20 °C.

Note: commercial reference buffer solutions traceable to the SI may be used.

For example: pH 1.679 ± 0.01 at 25°C
pH 4.005 ± 0.01 at 25°C
pH 7.000 ± 0.01 at 25°C

3.2. 0,1 M sodium hydroxide (NaOH) solution.

3.3. 4 g/l bromothymol blue indicator solution:

Bromothymol blue (C₂₇H₂₈Br₂O₅S): 4 g
Neutral ethanol 96 % vol: 200 ml

Dissolve and add:

Water free of CO₂: 200 ml

COMPENDIUM OF INTERNATIONAL ANALYSIS OF METHODS - OIV
Total acidity

1 M sodium hydroxide solution sufficient to produce blue-green colour
(pH 7) approximately 7.5 ml
Water to: 1000 ml

4. Apparatus

4.1 Potentiometer with scale graduated in pH values, and electrodes.

As a reminder, the glass electrode must be kept in distilled water. The calomel/saturated potassium chloride electrode must be kept in a saturated potassium chloride solution. A combined electrode is most frequently used: it should be kept in distilled water.

4.2 Conical flask 100 ml.

5. Procedure

5.1 Preparation of sample:

Introduce 200 g of accurately weighed rectified concentrated must. Make up to the mark with 500 ml water. Homogenize.

5.2 Potentiometric titration

5.2.1 Zeroing of the apparatus

Zeroing is carried out before any measurement is made, according to the instructions provided with the apparatus used.

5.2.2 Calibration of the pH meter

The pH meter must be calibrated at 20°C using standard buffer solutions traceable to the SI. The pH values selected must encompass the range of values that may be encountered in musts. If the pH meter used is not compatible with calibration at sufficiently low values, a verification using a standard buffer solution linked to the SI and which has a pH value close to the values encountered in the musts may be used.

5.2.3 Method of measurement

Into a conical flask (4.4), introduce a 50 ml of the sample, prepared as described in 5.1.

Add about 10 ml of distilled water and then add the 0.1 M sodium hydroxide solution (3.2) from the burette until the pH is equal to 7 at 20 °C. The sodium hydroxide must be added slowly and the solution stirred continuously.

Let n ml be the volume of 0.1 M NaOH added.

5.3 Titration with indicator (bromothymol blue)

5.3.1 Preliminary test: end-point colour determination.

COMPENDIUM OF INTERNATIONAL ANALYSIS OF METHODS - OIV
Total acidity

Into a conical flask (4.4) place 25 ml of boiled distilled water, 1 ml of bromothymol blue solution (3.3) and 50 ml of the sample prepared as in (5.1).

Add the 0.1 M sodium hydroxide solution (3.2) until the colour changes to blue-green.

Then add 5 ml of the pH 7 buffer solution (3.1)

5.3.2 Measurement

Into a conical flask (4.4) place 30 ml of boiled distilled water, 1 ml of bromothymol blue solution (3.3) and 50 ml of the sample, prepared as described in 5.1.

Add 0.1 M sodium hydroxide solution (3.2) until the same colour is obtained as in the preliminary test above (5.3.1).

Let n ml be the volume of 0.1 M sodium hydroxide added.

6. Expression of results

6.1 Method of calculation

- The total acidity expressed in milliequivalents per kilogram of rectified concentrated must is given by: $A = 5 \times n$

- The total acidity expressed in milliequivalents per kilogram of total sugars is given by:

$$A = (500 \times n)/P$$

P = % concentration (m/m) of total sugars.

It is recorded to one decimal place.

7. Characteristics of the method

Repeatability (r)

$$r = 0.4 \text{ meq /kg total sugars}$$

Reproducibility (R)

$$R = 2.4 \text{ meq /kg total sugars}$$

Method OIV-MA-F1-06

Type IV method

pH

OIV-OENO 419A-2011

1. Principle

The difference in potential between two electrodes immersed in the liquid under test is measured. One of these two electrodes has a potential which is a function of the pH of the liquid, while the other has a fixed and known potential and constitutes the reference electrode.

2. Reagents

2.1 Buffer solutions

2.1.1 Saturated solution of potassium hydrogen tartrate, containing at least 5.7 g of potassium hydrogen tartrate per litre ($C_4H_5KO_6$) at 20 °C. (This solution may be kept for up to two months by adding 0.1 g of thymol per 200 ml.)

pH/temperature

3.57 at 20 °C

3.56 at 25 °C

3.55 at 30 °C

2.1.2 Solution of potassium hydrogen phthalate, 0.05 M, containing 10.211 g of potassium hydrogen phthalate ($C_8H_5KO_4$) per litre at 20 °C. (Maximum keeping period, two months.)

pH/temperature

3.999 at 15 °C

4.003 at 20 °C

4.008 at 25 °C

4.015 at 30 °C

2.1.3 Solution containing:

monopotassium phosphate, KH_2PO_4 3.402 g

dipotassium phosphate, K_2HPO_4 4.354 g
water to 1 000 ml

(maximum keeping period, two months)

pH/temperature

6.90 at 15 °C

6.88 at 20 °C

6.86 at 25 °C

6.85 at 30 °C

Note: commercial reference buffer solutions traceable to the SI may be used.

For example: pH 1.679 ± 0.01 at 25°C

pH 4.005 ± 0.01 at 25°C

pH 7.000 ± 0.01 at 25°C

3. Apparatus

3.1 pH meter with a scale calibrated in pH units and enabling measurements to be made to at least ± 0.01 .

3.2 Electrodes:

3.2.1 Glass electrode.

3.2.2 Calomel-saturated potassium chloride reference electrode

3.2.3 Or a combined electrode.

4. Procedure

4.1 Preparation of the sample for analysis

Dilute the rectified concentrated must with water to produce a concentration of 25 ± 0.5 % (m/m) of total sugars (25 ° Brix).

If P is the percentage concentration (m/m) of total sugars in the rectified concentrated must, weigh a mass of:

$2500/P$

and make up to 100 g with water.

The water used must have a conductivity below 2 microsiemens per cm.

4.2 Zeroing of the apparatus

Zeroing is carried out before any measurement is made, according to the instructions provided with the apparatus used.

4.3 Calibration of the pH meter

The pH meter must be calibrated at 20°C using standard buffer solutions traceable to the SI. The pH values selected must encompass the range of values that may be encountered in musts. If the pH meter used is not compatible with calibration at sufficiently low values, a verification using a standard buffer solution linked to the SI and which has a pH value close to the values encountered in the musts may be used.

4.4 Determination

Dip the electrode into the sample to be analysed, the temperature of which should be between 20 and 25 °C and as close as possible to 20 °C.

Read the pH value directly off the scale.

Carry out at least two determinations on the same sample.

The final result is taken to be the arithmetic mean of two determinations.

5. Expression of results

The pH of the 25 % (m/m) (25 ° Brix) solution of rectified concentrated must is quoted to two decimal places.

6. Characteristics of the method

Repeatability (r)

$$r = 0.07$$

Reproducibility (R)

$$R = 0.07$$

Method OIV-MA-F1-07

Type IV method

Sulphur dioxide
OIV-OENO 419B-2011

1. Definitions

Free sulphur dioxide is defined as the sulphur dioxide present in the must in the following forms: : H_2SO_3 , HSO_3^-

The equilibrium between these forms is a function of pH and temperature:



H_2SO_3 represents molecular sulphur dioxide.

Total sulphur dioxide is defined as the total of all the various forms of sulphur dioxide present in the must, either in the free state or combined with its constituents.

2. Materials

Total sulphur dioxide is extracted from the previously diluted rectified concentrated must by entrainment at high temperature (approximately 100 °C).

2.1 Reagents

2.1.1 Phosphoric acid, 85 % (H_3PO_4) ($\rho_{20} = 1.71 \text{ g/ml}$).

2.1.2 Hydrogen peroxide solution, 9.1 g H_2O_2 /litre (three volumes).

2.1.3 Indicator reagent:

methyl red	100 mg
methylene blue	50 mg
alcohol 50 % vol.	100 ml

2.1.4 Sodium hydroxide solution (NaOH), 0.01 M.

2.2 Apparatus

2.2.1 The apparatus used should conform to the diagram shown below, particularly with regard to the condenser.

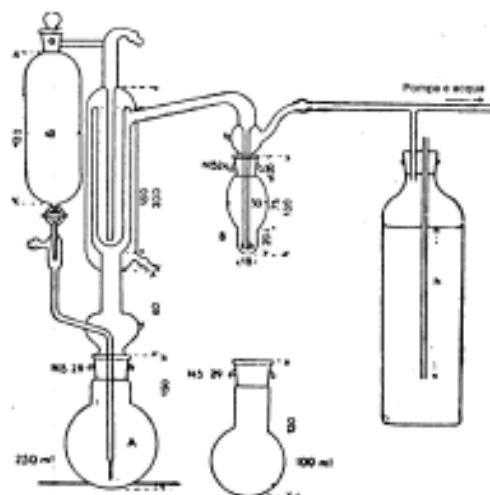

Fig. 1 The dimensions given are in millimetres. The internal diameters of the four concentric tubes forming the condenser are 45, 34, 27 and 10 mm.

The gas feed tube to the bubbler B ends in a small sphere of 1 cm diameter with 20 0.2-mm diameter holes around its largest horizontal circumference. Alternatively, this tube may end in a frit glass plate which produces a large number of very small bubbles and thus ensures good contact between the liquid and gaseous phases.

The gas flow through the apparatus should be approximately 40 litres per hour. The bottle on the right of the diagram is intended to restrict the pressure reduction produced by the water pump to 20 to 30 cm of water. To regulate the vacuum to its correct value, a flowmeter with a semi-capillary tube should be installed between the bubbler and the bottle.

2.2.2 A microburette.

3. Procedure

3.1 For rectified concentrated musts, use the solution obtained by diluting the sample to be analysed to 40 % (m/v) as indicated in the chapter 'Total acidity', section 5.1. Introduce 50 ml of this solution and 5 ml of phosphoric acid (2.2.1) into the 250 ml flask A of the entrainment apparatus. Connect the flask to the apparatus.

3.2 Place 2 to 3 ml of hydrogen peroxide solution (2.2.2) in the bubbler B, neutralize with the 0.01 M sodium hydroxide solution (2.2.4) and bring the must in the flask A to the boil using a small flame of 4 to 5 cm height which should directly touch the bottom of the flask. Do not put the flask on a metal plate but on a disc with a hole of approximately 30 mm diameter in it. This is to avoid overheating substances extracted from the sample that are deposited on the walls of the flask.

Maintain boiling while passing a current of air (or nitrogen). Within 15 minutes the total sulphur dioxide has been carried over and oxidized. Determine the sulphuric acid which has formed by titration with the 0.01 M sodium hydroxide solution (2.2.4).

Let n ml be the volume used.

4. Calculation

Total sulphur dioxide in milligrams per kilogram of total sugars (50 ml prepared test sample (3.1):

$$(1600 \times n)/P$$

where P = percentage concentration (m/m) of total sugars

5. Expression of results

Total sulphur dioxide is expressed in mg/kg of total sugars.

6. Characteristics of the method

Repeatability (r)

50 ml test sample < 50 mg/l; $r = 1 \times 250/P$ mg/kg of total sugars

Reproducibility (R)

50 ml test sample < 50 mg/l; $R = 9 \times 250/P$ mg/kg of total sugars

Method OIV-MA-F1-08

Type IV method

Chromatic Properties

OIV-OENO 419A-2011

1. Principle of the method

The absorbance of the rectified concentrated must is measured at 425 nm through a pathlength of 1 cm after dilution to bring the sugar concentration to 25 % (m/m) (25° Brix)

2. Apparatus

2.1 Spectrophotometer enabling measurements to be made between 300 and 700 nm.

2.2 Glass cells with optical paths of 1 cm.

2.3 Membrane filter of pore diameter 0.45 µm.

3. Procedure

3.1 Preparation of the sample

Use the solution with a sugar concentration of 25 % (m/m) (25° Brix) prepared as described in the chapter 'pH', section 4.1. Filter through a membrane filter of pore diameter 0.45 µm.

3.2 Determination of absorbance

Zero the absorbance scale at a wavelength of 425 nm using a cell with an optical path of 1 cm containing distilled water.

Measure the absorbance *A* at the same wavelength of the solution containing 25 % sugar (25° Brix) prepared as in 3.1 and placed in a cell with an optical path of 1 cm.

4. Expression of results

The absorbance at 425 nm of the rectified concentrated must in a solution with 25 % sugar (25° Brix) is quoted to two decimal places.

Repeatability (*r*)

$$r = 0.01 \text{ AU at } 25^\circ \text{Brix}$$

Method OIV-MA-F1-09

Type I Method

Specific methods for the analysis of grape sugar

Total cations

OIV-OENO 419B-2012

ANNEX A: TOTAL CATIONS

1. *PRINCIPLE*

The test sample is treated by a strongly acid cation exchanger. The cations are exchanged with H⁺. Total cations are expressed by the difference between the total acidity of the effluent and that of the test sample.

2. *APPARATUS*

2.1. Glass column of internal diameter 10 to 11 mm and length approximately 300 mm, fitted with a drain tap.

2.2. pH meter with a scale graduated at least in 0.1 pH units.

2.3. Electrodes:

- glass electrode, kept in distilled water,
- calomel/saturated potassium chloride reference electrode, kept in a saturated solution of potassium chloride,
- or a combined electrode, kept in distilled water.

3. *REAGENTS*

- 3.1. Strongly acid cation exchange resin in H⁺ form pre-swollen by soaking in water overnight.
- 3.2. Sodium hydroxide solution, 0.1 M.
- 3.3. Paper pH indicator.
- 3.4. The water used must be purified water for laboratories, with specific conductivity below 2 μS cm⁻¹ at 20°C, for example EN ISO 3696 type II water.

4. *PROCEDURE*

The pH meter must be calibrated according to the method OIV MA AS313-15

4.1. Preparation of sample

Use the solution obtained by diluting the rectified concentrated must to 40% (m/v). Introduce 200 g of accurately weighed rectified concentrated must. Make up to the mark with 500 ml water. Homogenize.

4.2. Total acidity of the rectified concentrated must

Titrate the acidity of the concentrated must in 100 ml of sample prepared as in 4.1 with the 0.1M sodium hydroxide solution until the pH is equal to 7 at 20 °C. The alkaline solution should be added slowly and the solution continuously shaken. Let n1 ml be the volume of 0.1 M sodium hydroxide solution used.

4.3. Preparation of the ion exchange column

Introduce into the column approximately 10 ml pre-swollen ion exchanger in H⁺ form. Rinse the column with distilled water until all acidity has been removed, using the paper indicator to monitor this.

4.4. Ion exchange

Pass 100 ml of the rectified concentrated must solution prepared as in paragraph 4.1 through the column at the rate of one drop every second. Collect the effluent in a beaker. Rinse the column with 50 ml of distilled water. Titrate the acidity in the effluent (including the rinse water) with the 0.1 M sodium hydroxide solution until the pH is 7 at 20°C. The alkaline solution should be added slowly and the solution continuously shaken. Let n₂ ml be the volume of 0.1 M sodium hydroxide solution used.

5. *EXPRESSION OF THE RESULTS*

The total cations are expressed in milliequivalents per kilogram of total sugar to one decimal place.

5.1. Calculations

– Total acidity of the rectified concentrated must in milliequivalents per kilogram:

$$a = 2.5 n_1$$

– Acidity of the effluent expressed in milliequivalents per kilogram of rectified concentrated must:

$$E = 2.5 n_2.$$

– Total cations in milliequivalents per kilogram of total sugars:

$$((n_2 - n_1) / (P)) \times 250$$

P = percentage concentration (m/m) of total sugars.

5.2 Repeatability (r)

$$r = 0.3$$

Method OIV-MA-F1-10

Type IV Method

Specific methods for the analysis of grape sugar
Heavy metals by ETAAS
(OIV-OENO 419B-2012)

ANNEX D: HEAVY METALS

Method Type IV

D.1 DETERMINATION OF LEAD LEVEL BY ETAAS

Heavy metals are described in detail in the steps for preparing grape sugar samples (concentrated musts and MCR rectified concentrated musts) for determining lead content.

The instrumentation and computer tools used in the testing laboratories vary and change.

As a result, general criteria for calibration and metrics are given.

1. Warning

SECURITY PRECAUTIONS – Operators must protect their hands and eyes when handling acids. Acids must be handled under an appropriate fume hood.

2. Scope

This method specifies an electrothermal atomic absorption spectrometry method (ETAAS) for determining the lead content of rectified concentrated musts between 10 µg/kg to 200 µg/kg.

3. Normative references

ISO 3696, Water for analytical laboratory use — Specification and test methods

4. Principle

In Electrothermal Atomic Absorption Spectrometry (ETAAS), a sample volume is inserted into a graphite tube which may be heated to over 2800°C. When the temperature is gradually increased, the sample matrix dries and thermal decomposition and dissociation occur. For most elements, the peak height is proportional to the concentration of the element in the solution, although in a very large number of cases, it is preferable to work with the peak area.

5. Reagents and solutions

Unless otherwise indicated, only use lead-free reagents of recognised analytical quality.

5.1 Demineralised, ultra-pure water with resistivity above 18 MΩ, following ISO 3696.

5.2 Nitric acid of a concentration above 60% (Normapur quality).

5.3 Ammonium dihydrogen phosphate $\text{NH}_4\text{H}_2\text{PO}_4$

5.4 Matrix modifier: $\text{NH}_4\text{H}_2\text{PO}_4$, 6% solution

Pour 3g of $\text{NH}_4\text{H}_2\text{PO}_4$ into a 50 ml volumetric flask. Dissolve and bring to volume with demineralised water.

5.5 Magnesium nitrate $\text{Mg}(\text{NO}_3)_2$ to 6 molecules of water

5.6 0.5% magnesium nitrate solution (keep refrigerated).

Pour 0.5g of magnesium nitrate into a 100 ml volumetric flask. Dissolve and bring to volume with demineralised water. Keep this solution refrigerated for a maximum of 15-20 days.

5.7 Certified mono element lead solution(s) (at 1000 mg/l)

5.8 10 mg/l lead solution

Place 1 ml of the stock solution (5.7) and 10 ml of nitric acid (5.2) in a 100 ml flask. Bring to volume with ultra-pure water (5.1).

5.9 100 µg/l lead solution

Place 1 ml of the stock solution (5.8) in a 100 ml flask. Add 10 ml of nitric acid (5.2). Bring to volume with ultra-pure water (5.1).

5.10 Triton X-100 (1% v/v)

5.11 Blank test: 10% nitric acid

Preparation of the calibration range

The number of calibration solutions depends on the required precision. At least five standards are required. The precision and accuracy of the results may be verified by analysing a control sample.

It should be stressed that the linearity of the calibration curve is often limited.

Correct the absorbance values of the calibration solutions by subtracting the absorbance value of the blank test. To plot a calibration curve or calculate the calibration function, use the values obtained as well as the analyte concentration of the calibration solutions.

Depending on the type of apparatus, it is possible to work with an autosampler to direct inject predetermined volumes from the 100 µg/l solution in order to have a calibration range of 0 to 100 µg/l (e.g. 0, 10, 25, 50, 100 µg/l). It is also possible to prepare calibration solutions separately.

Note 1: A smaller volume of test sample may be used to determine lead content greater than 100 µg/l.

6. Apparatus and equipment

6.1 **Atomic absorption spectrometer** equipped with an electrothermal atomiser, a hollow-cathode lamp adapted for lead functioning with the manufacturer-recommended current, an automatic correction device for background noise and a computer reading system or high-speed graphic recorder. A correction of background noise should be used with electrothermal atomic absorption spectrometry. The minimum acceptable technical specification is based on deuterium. A correction of the Zeeman background noise is preferable if the signal from background noise is high. To increase the analyte signal-to-noise ratio, the use of a graphite tube with a pyrolytic platform is recommended.

Note 2: a wavelength of 217.0 nm can be used for lead. The sensitivity is about two times higher than that obtained at 283.3 nm. However, since the noise and risk of interference are greater, it is necessary to work with a Zeeman background noise correction system.

6.2 Precision balance accurate to 0.1 mg

6.3 Class A graduated pipettes: 0.5 ml, 1 ml, 5 ml

6.4 Class A volumetric flasks: 50 ml and 100 ml

Note 3: the material in contact with the sample must remain in a 10% nitric acid solution (5.2) for at least 12 hours and must be subsequently rinsed several times with demineralised water (5.1).

7. Sampling

Preparation of the sample for testing

In a 50 ml flask (6.4), pour 10 g of the sample accurate to 0.1 mg, 5 ml of nitric acid (5.2), and 0.5 ml of triton X-100 (1% v/v) (5.10). Bring to 50 ml with the demineralised water (5.1) and homogenise.

8. Procedure

Adjust the instrumental parameters and align the electrothermal atomiser following the manufacturer's instructions in order to derive maximum benefit from the background noise correction system. Adjust the sampler in the same way. Determine the optimal parameters for the electrothermal atomiser for the particular type of atomiser and sample volume, as recommended by the apparatus manufacturer, in order to cover the optimal measuring range. Adjust the baseline of the apparatus to zero. Verify the stability of zero in the atomisation system by executing the predefined temperature programme for the white heating of the graphite atomiser. The following furnace settings may be used:

phase	temperature (°C)	level-off (s)	rise (ramp) (°C/s)	type of gas	gas speed (l/mn)	reading
1	130	15	10	argon	0.2	no
2	350	5	25	argon	0.2	no
3	500	5	50	argon	0.2	no
4	750	10	100	argon	0.2	no
5	1900	3	0	argon	stopped	yes
6	2500	3	0	argon	0.2	no
7	100	10	0	argon	0.2	no

Using an autosampler, inject a set volume of the solution. Add a set volume of modifier solution and atomise the blank test (5.11), the calibration solutions and the diluted test sample solutions by order of increasing response of the apparatus. If the peak height (or the peak area) of the test sample is greater than the value of the calibration solution with the highest concentration, a lower test sample volume must be used.

External calibration

The following programme for the sampler is given as an example (volume in µl) to determine the lead content through external calibration.

	blank test	sample	standard 1 10 µg/l	standard 2 25 µg/l	standard 3 50 µg/l	standard 4 100 µg/l
blank (HNO ₃ 10%)	5.0					
thinner (HNO ₃ 10%)			4.5	3.7	2.5	0
sample		5.0				
stock solution (Pb 100 µg/l)			0.5	1.3	2.5	5.0
NH ₄ H ₂ PO ₄ 6%	4.0	4.0	4.0	4.0	4.0	4.0
Mg(NO ₃) ₂ 0.5%	2.0	2.0	2.0	2.0	2.0	2.0
total volume	11.0	11.0	11.0	11.0	11.0	11.0

Atomise each solution at least two times and, if the reproducibility is acceptable in compliance with the quality control system used in the laboratory, calculate the average of readings. If necessary, reset the baseline to zero.

Addition method

It is also possible to use the addition method to reduce the effect of non-spectral interferences between the standards and the samples, as long as the calibration curve is linear in the absorbance range used.

Transfer identical volumes of the testing sample in three receptacles (for example, autosampler cups). Add a small quantity of standard solution to two of the receptacles, calculated in order to obtain a concentration for the samples, respectively, of between 100% and 200% higher than the concentration in the original sample. Add the same quantity of water in the third receptacle. Carefully mix the solutions. Measure the integrated absorbance of each solution and plot a curve with the added concentration on the *x*-axis and the measured absorbance on the *y*-axis. Determine the analyte concentration of the reagent blank solution or the test blank solution in the same manner.

The following programme for the sampler is given as an example (volume in µl) to determine the lead content using the addition method.

	blank test	sample	addition 1 25 µg/l	addition 2 50 µg/l
blank (HNO ₃ 10%)	5.0			
thinner (HNO ₃ , 10%)	2.5	2.5	1.2	0
sample		5.0	5.0	5.0
stock solution (Pb 100 µg/l)			1.3	2.5
NH ₄ H ₂ PO ₄ 6 %	1.0	1.0	1.0	1.0
Mg(NO ₃) ₂ 0.5%	2.0	2.0	2.0	2.0
total volume	10.5	10.5	10.5	10.5

9. Calculation

The apparatus software establishes the calibration graph (absorbance as a function of lead concentration in µg/l). It gives the lead concentration of the samples. Take into account any dilution, if applicable.

10. Precision parameters

For a lead concentration inferior to 150 µg/kg:

r (Repeatability) = 15 µg/kg

R (Reproducibility) = 25 µg/kg

11. Bibliography

13.1 Laboratoire SCL33. *Détermination du plomb dans le vin par atomic absorption spectrometry (four-graphite)*. Manuel d'instructions, 2010.

13.2 Laboratoire SCL33. *Détermination du plomb dans les aliments solides par atomic absorption spectrometry (four-graphite)*. Manuel d'instructions, 2010.

13.3 Rodriguez Garcia J.C. *Desarrollo de metodologías para la determinación de metales en miel mediante ETAAS y estudio quimiométrico de su empleo como bioindicador*. Universidad de Santiago de Compostela, Facultad de Ciencias, Campus de Lugo, 2006.

Method OIV-MA-F1-11

Type IV Method

Specific methods for the analysis of grape sugar
Heavy metals by ICP-MS
(OIV-OENO 419B-2012)

ANNEX D.2: HEAVY METALS

Determination of lead content by Inductively Coupled Plasma Mass Spectrometry (ICP-MS).

The analysis of Pb in rectified concentrated grape musts can also be performed applying the **method OIV/OENO344/2010** (Multielemental Analysis Using ICP-MS), with the following modification added at the end of point N°5 (Sample preparation):

5. SAMPLE PREPARATION

This method can also be applied to the analysis of Pb in rectified concentrated grape musts. For this purpose, a prior mineralisation of the sample is required. A digestion of the samples in a close vessel microwave system is recommended. The following procedure is given as a way of example:

Ad 1 g of must, 2 ml of nitric acid (3.4) and 8 ml of water (3.1) in a microwave vessel, and apply the following microwave digestion programme:

Stage	ramp	°C	Hold
1	20 min	200	20 min

Once the samples have been digested, transfer them to a 50 ml plastic tube (4.6), dilute with water (3.1) to 30g and homogenize.

Method OIV-MA-F1-12

Methode type II

Specific methods for the analysis of grape sugar
Determination of meso-inositol, scyllo-inositol and sucrose
OIV-OENO 419C-2015

1. PRINCIPLE

Rectified Concentrated Must (RCM) is mainly composed of sugars, polyalcohols and water contained in grapes. All the other organic and mineral components are removed during the rectification process.

Meso-inositol, scyllo-inositol and sucrose are determined through gas chromatography (GC) following silanisation.

The sucrose possibly found in small amounts in the RCM is stable for some months since hydrolysis is greatly slowed down due to the absence of organic and mineral acids, which are removed during the rectification process, to a very low water content, and to a high level of glucose and fructose.

2. REAGENTS

2.1. Xylitol (CAS no. 87-99-0)

Internal standard: (aqueous solution of at a precisely known concentration of about 10 g/L prepared at the time).

COMPENDIUM OF INTERNATIONAL METHODS OF ANALYSIS-OIV
Specific methods for the analysis of grape sugar

- 2.2. Meso-inositol (C₆H₁₂O₆) (CAS no. 87-89-8)
- 2.3. Scyllo-inositol (C₆H₁₂O₆) (CAS no. 488-59-5)
- 2.4. Glucose (C₆H₁₂O₆), fructose (C₆H₁₂O₆), sucrose (C₁₂H₂₂O₁₁)
- 2.5. Bis(trimethylsilyl)trifluoroacetamide - (BSTFA) – (C₈H₁₈F₃NOSi₂) (CAS no. 25561-30-2)
- Warning: This is a dangerous and inflammable product. Inflammable liquids and vapours may provoke serious skin burns and serious eye lesions. Wear gloves/protective clothing. Protect your eyes/face.*
- 2.6. Trimethylchlorosilane (C₃H₉ClSi) – TMCS – (CAS no. 75-77-4)
- Warning: This is a dangerous and inflammable product. Harmful to the skin. Provokes serious skin burns and serious ocular lesions. Toxic when inhaled. May irritate the respiratory tract. Keep away from sources of heat/sparks/free flames /heated surfaces. Do not smoke. Avoid inhaling the vapours. Wear gloves/protective clothing. Protect your eyes/face.*
- 2.7. Pyridine p.a. (C₅H₅N) (CAS no. 110-86-1)
- Warning: This is a dangerous and inflammable product. Noxious when inhaled, in contact with the skin and when swallowed.*
- 2.8. Absolute ethanol (C₂H₆O) (CAS no. 64-17-5)
- Warning: This is an inflammable product. Liquid and vapours easily inflammable. Keep away from sources of heat/sparks/free flames /heated surfaces. Do not smoke.*
- 2.9. Type 1 Water in conformity with ISO 3696 standard or deionised water with resistivity ≥ 18MΩ cm
- 2.10. The silanising reagent is also available in ready to use kits (e.g. HMDS+TMSCl+Pyridine 3:1:9 Supelco cod. 33038)
- 2.11. Technical gases: nitrogen, hydrogen, helium and air for gas chromatography and for the dehydration phases

3. APPARATUS

3.1. Gas chromatograph

3.2. Capillary column able to guarantee a minimum efficiency of $N=250,000$ plates/column for sucrose at 1 g/L

For example, OV-1 (25 m x 0.30 mm x 0.15 μm) or DB-5 (60 m x 0.25 mm x 0.10 μm).

Operating conditions (only as an example):

carrier gas: pure hydrogen or helium, for gas chromatography,

Hydrogen: *Warning: This is an extremely inflammable gas. Store the container in a well-ventilated place and far from flames and sparks. – Do not smoke. Avoid the piling up of electrostatic loads.*

carrier gas flow rate: about 2 mL/min,

injector temperature: 250 °C,

temperature of flame ionisation detector (FID): 300 °C,

programming of temperature: 1 minute at 160 °C, 4 °C/minute up to 260 °C, constant temperature of 260 °C for 15 minutes,

splitter ratio: about 1:20,

auxiliary gases: pure hydrogen and air for gas chromatography.

3.3. Integrator

3.4. Microsyringe: 10 μL

3.5. Micropipettes: 10, 100, 400 and 1000 μL

3.6. 2 mL flasks with Teflon stopper

- 3.7. Oven
- 3.8. Technical balance, analytical balance able to ensure an accuracy of ± 0.1 mg
- 3.9. Flasks of 50 and 100 mL
- 3.10. Dryer

4. PROCEDURE

4.1 Preparation of the sample

In a 50 mL flask, weigh a quantity “p” of rectified concentrated must ranging between 4.9 and 5.1 g, noting the weight of the substance with the precision of ± 0.1 mg.

Then add 1 mL of xylitol standard solution (2.1) and bring to volume with water (2.9).

4.2 Dehydration of the sample

After mixing, 100 μ L of solution is taken and placed in a flask (3.6) where it is dried under a gentle stream of nitrogen.

100 μ L of absolute ethanol (2.8) may be added to facilitate evaporation.

Note 1: In case a precise dose of sucrose is desired, the diluted solution should be prepared just before the silanisation, in order to limit hydrolysis of the sucrose in the diluted aqueous solution.

Note 2: The repeated measurements of the sucrose content have to be performed on diluted solutions prepared every time before every silanisation.

4.3 Derivatization

The residue is carefully dissolved in 100 µL of pyridine (2.7) and 100 µL of bis (trimethylsilyl)trifluoroacetamide (2.5) and 10 µL of trimethylchlorosilane (2.6) are added. The flask is closed with the Teflon stopper and placed in the oven at 70 °C for 70 minutes.

Take the sealed flasks out of the oven and leave to cool in the dryer in the dark at room temperature for an hour before injecting into the gas chromatograph.

The substance conserved in the sealed flask and kept in the dryer in the dark at room temperature is stable for three days.

Note 3: If working with a silanisation kit, 400 µL of reagent should be used per 100 µL of the dehydrated and diluted sample, as described in 4.1.

Note 4: The silanisation is considered successful if the solution, after a sole phase, has a clear appearance or leaves a slight, white residue. There should not be a dark residue since this would indicate an excess of non-derivatised sugar or an aged silanising substance.

Note 5: Should there be a white suspension, wait until the solid matter deposits on the bottom without centrifuging.

4.4 Gas chromatographic analysis

1 µL is taken with a syringe (3.4) and injected into the chromatograph with the aforementioned splitter.

The chromatogramme should not show a confluence of peaks (sign of a badly performed silanisation), but characteristic peaks as shown in the attached figures. (Fig.9-Fig.12).

4.5 Peak integration criteria

Integrate the gas chromatographic peaks with respect to the horizontal baseline. In case of peaks that are not perfectly resolved, trace the horizontal baseline starting from the deeper valleys that delimit the peak

in question. Trace a vertical line downwards starting from the valleys of the peaks up to the baseline to identify the peak area.

Do not use the valley-valley integration method.

An example of the application of these criteria is given in Figure 10 for the internal standard, in Figure 11 for the inositols and in Figure 12 for the sucrose.

Note 6: In case a precise dose of sucrose is desired, it is important to respect the integration criteria explained in paragraph 4.4. and shown in Figure 4.

5. CALCULATIONS

5.1. Calculation of response factors

Note: instead of the calculation of response factors a calibration curve can be used

5.1.1 A solution is prepared containing:

- 60 g/L of glucose,
- 60 g/L of fructose,
- 1 g/L of meso-inositol,
- 1 g/L of sucrose,

(weigh 60 g of glucose and 60 g of fructose with precision ± 1 g; then 1 g of meso-inositol and 1 g of sucrose with precision ± 0.1 mg) and lastly bring to volume of 1 litre with water.

5.1.2 Silanisation of the reference solution

Carry out the operations described in paragraph 4.1 starting with 5 mL of said solution in place of the 5 g of RMC

Take 5 mL of the solution and proceed as in paragraph 4.

5.1.3 Gaschromatographic response factors

The results for meso-inositol and sucrose with respect to xylitol are calculated from the chromatogram.

In the case of scyllo-inositol, which has a retention time lying between the last peak of the anomeric form of glucose and the peak for meso-inositol (see Figure 11), use the same response factors achieved for meso-inositol.

Where: $A_{\text{meso-inositol}}$ = area of the meso-inositol peak; A_{sucrose} = area of the sucrose peak; A_{is} = area of the internal standard peak; $C_{\text{meso-inositol}}$ = concentration of meso-inositol in mg/L; C_{sucrose} = concentration of sucrose in mg/L; C_{is} = concentration of internal standard in mg/L, the following formula is true:

$$RF_{\text{meso-inositol}} = \frac{A_{\text{meso-inositol}}}{A_{\text{is}}} \times \frac{C_{\text{is}}}{C_{\text{meso-inositol}}}$$

$$RF_{sucrose} = \frac{A_{sucrose}}{A_{is}} \times \frac{C_{is}}{C_{sucrose}}$$

The solution for the calculation of the response factors has to be prepared and analysed on the same day (see note 1 of paragraph 4.1).

5.2. Formulation of the results

Meso-inositol, scyllo-inositol and sucrose are expressed in mg/kg of Total Sugars (mg/kg TS) without decimals.

5.2.1 Concentrations expressed in mg/L for the 10% (w/v) solution of RCM (4.1):

$$C_{meso-inositol} \left(\frac{mg}{l} \right) = \frac{C_{is}}{RF_{meso-inositol}} \times \frac{A_{meso-inositol}}{A_{is}}$$

$$C_{sucrose} \left(\frac{mg}{l} \right) = \frac{C_{is}}{RF_{sucrose}} \times \frac{A_{sucrose}}{A_{is}}$$

5.2.2 Concentrations expressed in mg/kg of Total Sugars (mg/kg TS) for the meso-inositol and the scyllo-inositol, and for the sucrose in the RCM.

Indicating with “i” any of the three compounds:

$$CONC_i \left(\frac{mg}{kg TS} \right) = C_i \times \frac{5000}{w \times G}$$

Where “w” is the weighed amount in g of the RCM and “G” is the percentage of sugar of the RCM expressed in °Brix [or % (m/m) of sucrose]. The sugar percentage of the RCM sample should be measured using the OIV-MA-AS2-02 method.

6. CHARACTERISTICS OF THE METHOD

6.1 Critical points

The method regards the analysis of sugars and polyalcohols found in extremely small quantities in a matrix of glucose and fructose in very high concentrations. It is thus necessary to verify the method’s capacity to furnish linear responses in the range of concentrations proposed and that are sufficiently accurate compared with known values.

Furthermore, the method provides for gas chromatographic analysis of the silanised compounds obtained through derivatisation of the sugars. These compounds are sensitive to humidity and tend to deteriorate with time. It is therefore important to verify the adequacy of the instructions regarding conservation and handling of these compounds.

Lastly, sucrose is subject to hydrolysis due to the quantity of residual water in the RCM (from 30 to 45%). However, the low acidity of the matrix and the high concentration of glucose and fructose slow down the hydrolysis process and allow accurate measurements to be carried out. It is therefore important to check that the analysis timeframes are fast compared to the hydrolysis in order to allow repeatable measurements of the sucrose.

6.2 Linearity

A series of six synthetic samples were prepared (including the blank) containing a matrix of glucose and fructose obtained by weighing equal quantities of the two sugars in relation to a 60% (w/w) content of total sugars in the initial RCM.

To five of these synthetic samples, precise amounts in increasing quantities of meso-inositol and sucrose were added so as to achieve the concentrations shown in the following table:

concentration added		
No.	meso-inositol (mg/kg TS)	sucrose (mg/kg TS)
1	0 (blank)	0 (blank)
2	214.7	427.3
3	420.0	857.7
4	840.2	1675.8
5	1727.0	3338.0
6	2514.0	6719.0

The samples were then diluted (4.1), the diluted solution was dehydrated (4.2), silanised (4.3) and analysed with the GC (4.4-4.5).

The samples were then silanised and analysed using GC. The results were verified in order of linearity, showing on the graph the ratio between the peak areas of the meso-inositol peaks and that of the internal standard (A_{meso}/A_s), and the ratio between the concentration of meso-inositol and of the internal standard (in mg/L), indicated by $C_{\text{meso}}/C_{\text{is}}$. The GC analysis was conducted twice and the following data refer to the mean of the two values.

The same treatment was applied to the sucrose as follows

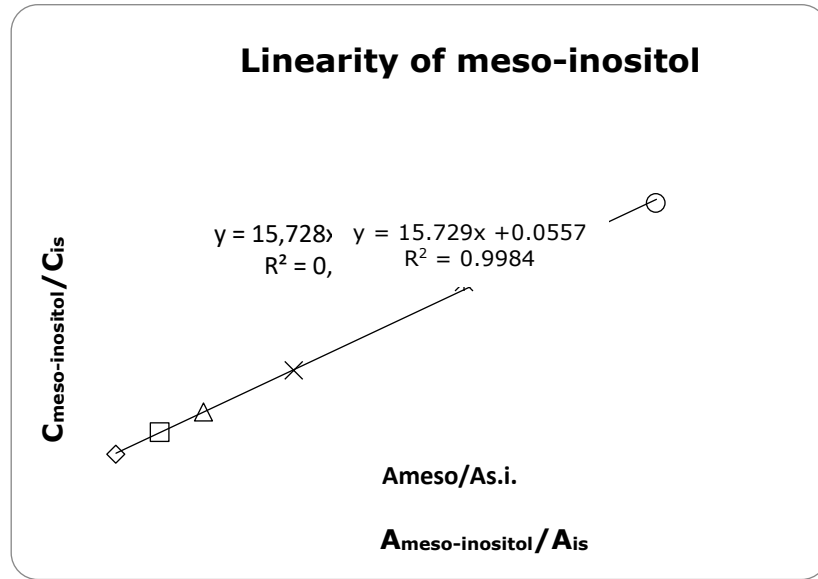

Fig. 1 Linearity of meso-inositol

The linearity of the meso-inositol is highly satisfactory ($R > 0.998$) in the entire range of concentration studied.

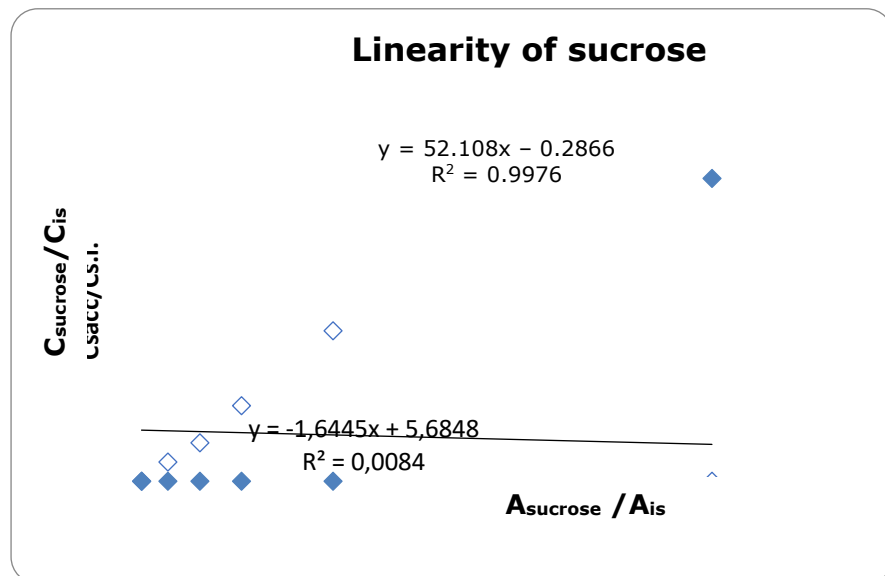

Fig. 2 Linearity of sucrose

In relation to sucrose, the linear relationship hypothesised over the entire range of concentrations studied did not lead to a satisfactory correlation ($R=0.967$) but, by narrowing down the linearity field to the synthetic sample no. 5, the correlation became comparable to that of meso-inositol ($R>0.997$).

Following the instructions in par. 5.1, the following response factors were obtained:

RF rel. Meso-inositol/Xylitol I.S.	RF rel. Sucrose/Xylitol I.S.
1.04 ± 0.03 (mean $\pm \sigma$; n=4)	0.36 ± 0.06 (mean $\pm \sigma$; n=4)

6.3 Specificity

The relationship between the added meso-inositol and that determined by GC is linear in the entire measurement range studied, and the slope of the line is very close to one and intercept is very close to zero.

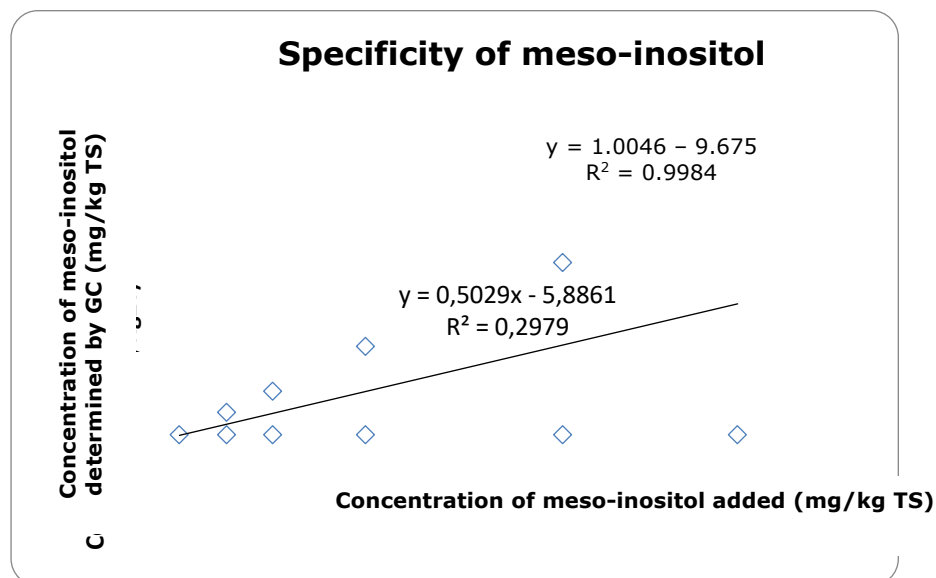

Fig. 3 Specificity of meso-inositol

Also, the recovery is satisfactory at between 95 and 105%, as seen in the following table:

$C_{\text{meso-inositol added}}$ (mg/kg TS)	$C_{\text{meso-inositol determined by GC}} \pm \sigma$ (n=2) (mg/kg TS)	Recovery (%)
0	0	-
214.7	213 ± 2	99%
420.0	419 ± 3	100%
840.2	852 ± 20	102%
1727.0	1668 ± 214	100%
2514.0	2587 ± 36	99%

As to the specificity of the sucrose, the concentrations obtained from the calculation of the added sucrose and that determined by GC conform and are in a linear relationship with each other, with a slope of one and intercept of almost zero, on the condition, however, that the concentration range is more restricted compared to that studied.

The following graph shows that the linear relationship does not extend up to the last concentration level of about 6700 mg/kg TS.

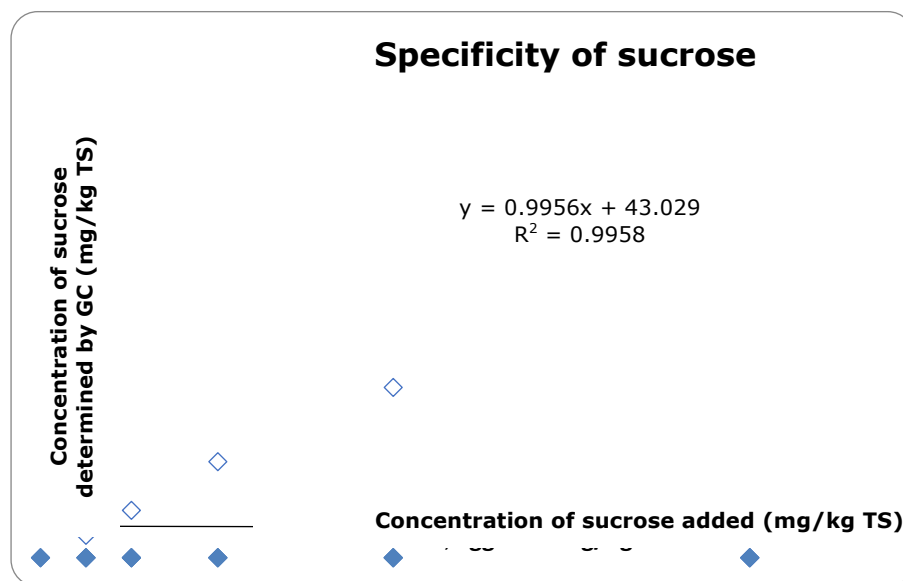

Fig. 4 Specificity of sucrose

Also, the recovery is satisfactory, at between 90 and 110%, excluding the higher concentration levels, as seen in the following table:

$C_{\text{sucrose added}}$ (mg/kg TS)	$C_{\text{sucrose determined by GC}} \pm \sigma$ (n=2) (mg/kg TS)	Recovery (%)
--	--	--------------

COMPENDIUM OF INTERNATIONAL METHODS OF ANALYSIS-OIV
Specific methods for the analysis of grape sugar

0	0	-
427.3	423 ± 16	99%
857.7	913 ± 37	107%
1675.8	1852 ± 344	111%
3338.0	3297 ± 284	99%
<u>6719.0</u>	<u>9220 ± 19</u>	<u>137%</u>

6.4 Stability of sucrose in rectified concentrated must

A sample of the RCM with added sucrose was kept at room temperature and analysed at regular time intervals in order to see the incidence of the hydrolysis phenomenon of sucrose in RCM.

The results are summarised in the following table:

	t = 0 days	t=9 days	t=53 days
Meso-inositol (mg/kg TS)	2227	2100	2052
Scyllo-inositol (mg/kg TS)	424	430	394
Sucrose (mg/kg TS)	4631	5108	4969

Both the meso-inositol and the scyllo-inositol, as well as the sucrose, do not show significant variations in concentration compared to the initial value up to 53 days after the preparation.

This fact appears to be evident in the following graph:

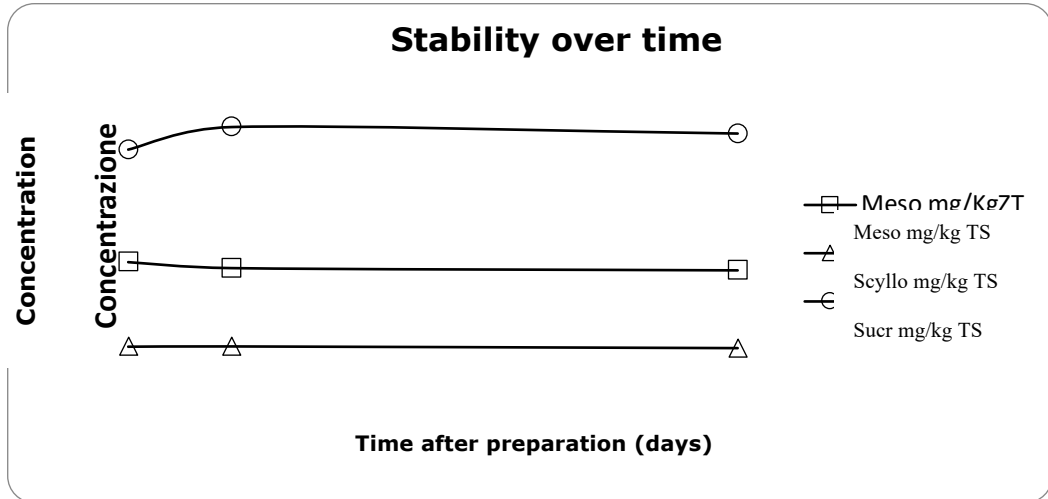

Fig. 5 Stability over time

6.5 Stability of the silanised sample

The silanised product obtained as described in point 4.2 was conserved as described in the same paragraph. At 24-hour intervals the silanised sample was analysed with the gas chromatograph following the procedure set out in point 4.3 and the succeeding points.

The results are described in the following table:

COMPENDIUM OF INTERNATIONAL METHODS OF ANALYSIS-OIV
Specific methods for the analysis of grape sugar

	t=0 mean ± SD (n=3)	t=24 h mean ± SD (n=3)	t=48 h mean ± SD (n=3)	t=72 h mean ± SD (n=3)	t=96 h mean ± SD (n=3)
Meso- inositol (mg/kg TS)	2424 ± 109	2347 ± 44	2358 ± 17	2453 ± 39	2478 ± 15
Scyllo- inositol (mg/kg TS)	261 ± 7	254 ± 2	256 ± 4	257 ± 3	264 ± 1
Sucrose (mg/kg TS)	6233 ± 971	6500 ± 200	6633 ± 58	6733 ± 321	6600 ± 436

There are no significant differences between the results obtained from the same silanised sample up to 4 days after silanisation, adopting the measures for the conservation of the silanised sample described in point 4.2.

This fact is evident in the following graphs:

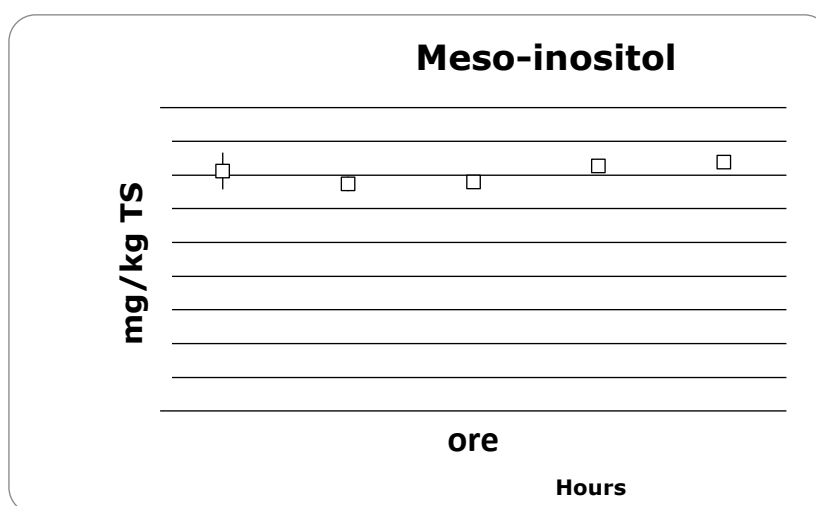

Fig. 6 Stability of Meso-inositol

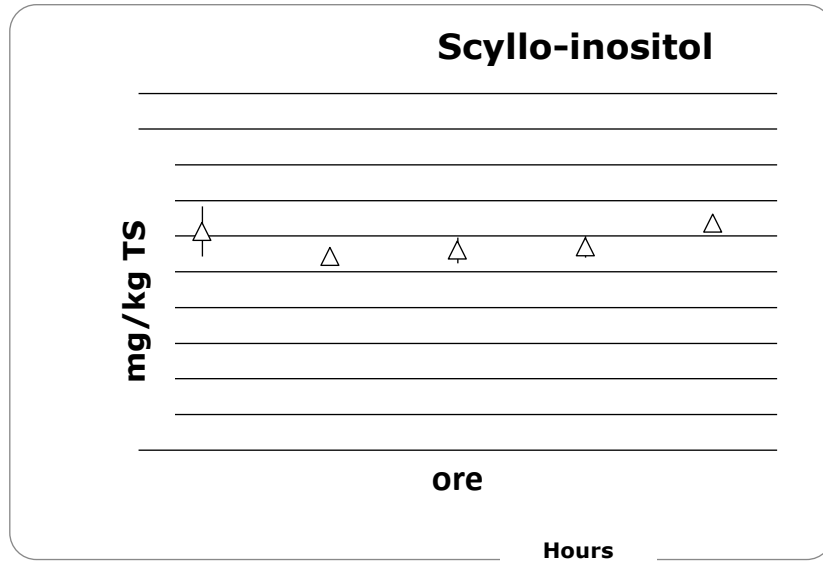

Fig. 7 Stability of Scyllo-inositol

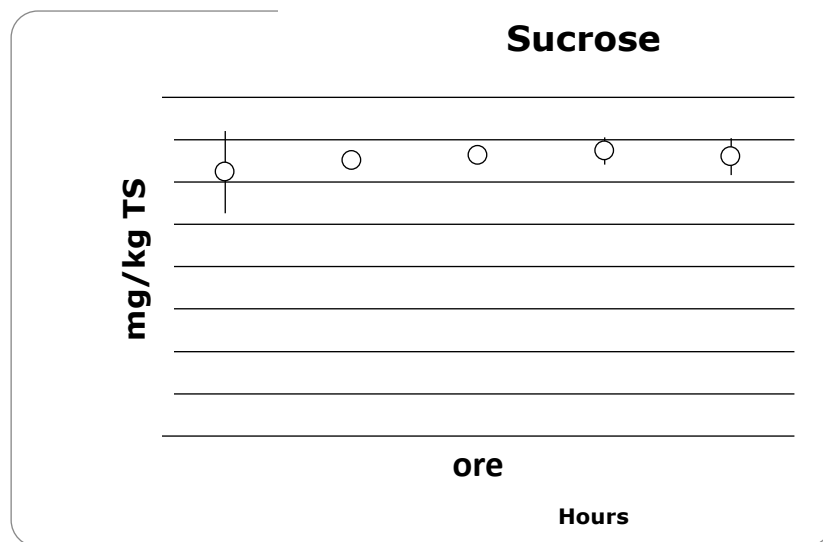

Fig. 8 Stability of Sucrose

COMPENDIUM OF INTERNATIONAL METHODS OF ANALYSIS-OIV
Specific methods for the analysis of grape sugar

6.6 Precision

Precision parameters obtained in the interlaboratory test conducted in April 2014 between 8 Italian laboratories. The Ring Test was performed on a sample with added sucrose at a concentration of 1 g of sucrose / 1 kg RCM

	sucrose	meso- inositol	scyllo- inositol
Number of participating laboratories	8	8	8
Number of accepted test results	23	23	23
Mean values (mg/kg TS)	1665	954	145
Repeatability			
Repeatability standard deviation (Sr)	78	52	11
Relative repeatability standard deviation (%RSD _r)	4.7	5.4	7.3
Repeatability limit (r)	219	146	29
HORRAT r = RSD _r / RSD(R) Horwitz	0.9	1.0	1.0
Reproducibility			
Reproducibility standard deviation (SR)	122	76	19
Relative reproducibility standard deviation (%RSD _R)	7.4	8.0	13
Reproducibility limit (R)	343	213	55
RSD(R) Horwitz %	5.2	5.7	7.6
HORRAT R = RSD _R / RSD(R) Horwitz	1.4	1.4	1.8
S _r /S _R	0.64	0.68	0.58

7. BIBLIOGRAPHY

- 7.1 Versini G., Dalla Serra A. and Margheri G. (1984). *Polialcool e zuccheri minori nei mosti concentrati rettificati. Possibili parametri di genuinità?* Vignevini, 11(3), 41-47
- 7.2 Monetti A., Versini G., Dalpiaz G. and Raniero F. (1996). *Sugar adulterations control in concentrated rectified grape musts by finite mixture distribution analysis of the myo-inositol and scyllo-insitol content and the D/H methyl ratio of fermentative ethanol.* Journal of Agricultural and Food Chemistry, 44-8: 2194-2210.

8. FIGURES

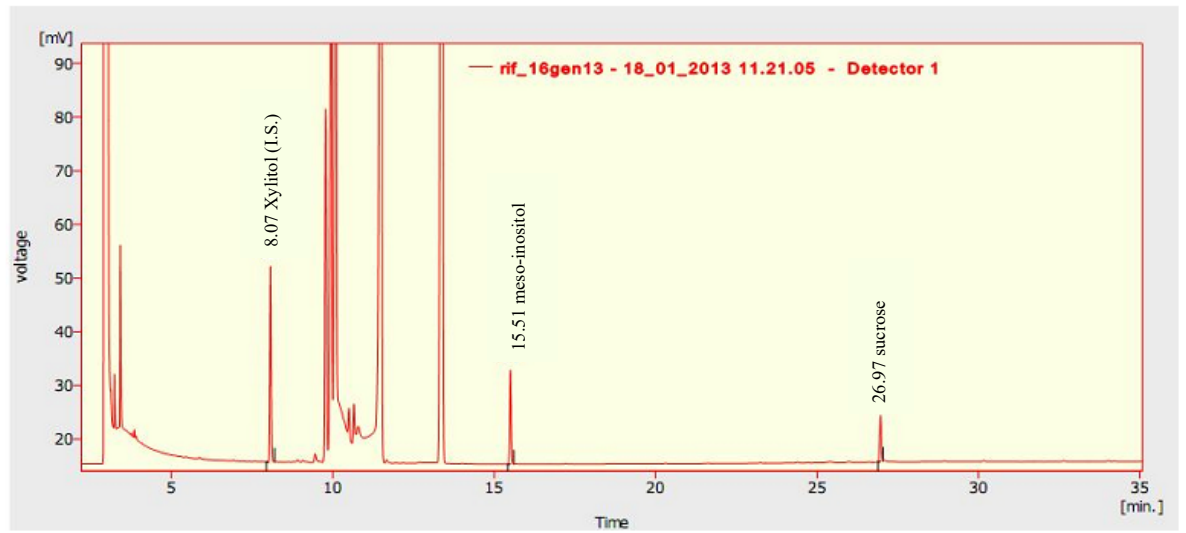

Fig. 9 Chromatogram of the reference solution for the calculation of response factors

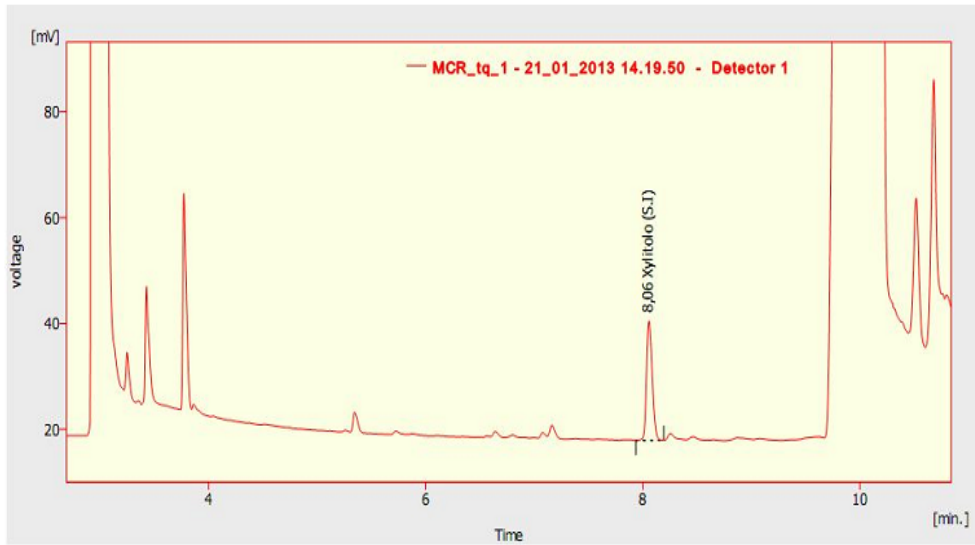

Fig. 10 Chromatogram of an RCM sample – Internal Standard ZONE

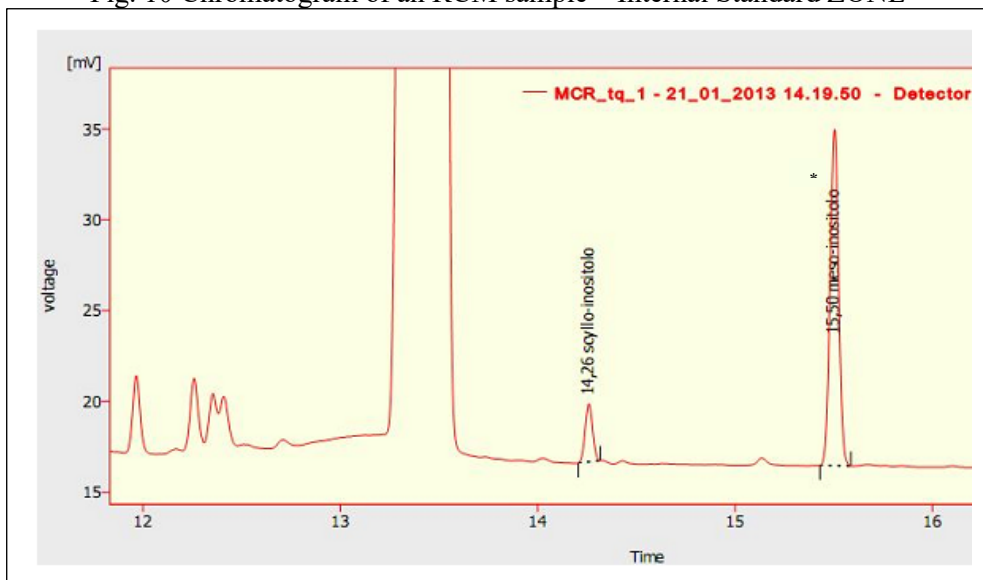

Fig. 11 Chromatogram of an RCM sample - "Inositol" ZONE

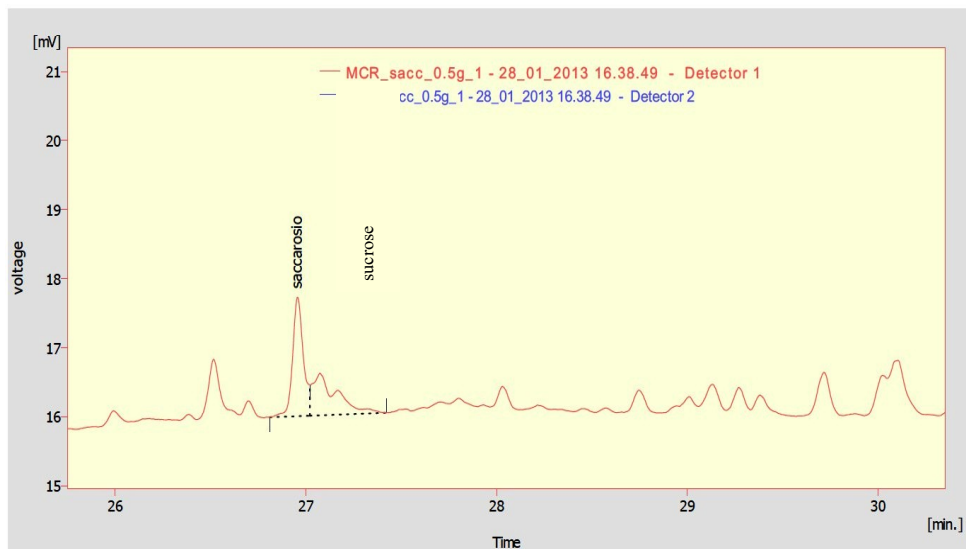

Fig. 12 Chromatogram of an RCM sample –with 0.5 g/kg sucrose added

Method OIV-MA-F1-13

Method type IV

Specific methods for the analysis of grape sugar
Folin-Ciocalteu Index
(OIV-OENO 419D-2015)

1. DEFINITION

The Folin-Ciocalteu Index is (IFC) the result obtained from the application of the method described below.

This method applies to rectified concentrated must (RCM).

2. PRINCIPLE OF THE METHOD

All phenolic compounds contained in RCM are oxidized by the Folin-Ciocalteu reagent. In RCM other reducing substances can interfere such as, for example, sugars and sulfur dioxide. This interference can be evaluated by measuring a "blank" devoid of phenolic substances, prepared by treating the corresponding sample with activated charcoal.

The Folin-Ciocalteu reagent is formed from a mixture of phosphotungstic acid ($H_3PW_{12}O_{40}$) and phosphomolybdic acid ($H_3PMo_{12}O_{40}$) which, after oxidation of the reducing substances present in the RCM, is reduced to a mixture of the blue oxides of tungsten (W_8O_{23}) and molybdenum (Mo_8O_{23}). The blue coloration produced has a maximum absorption in the region of 750 nm.

3. REAGENTS

These must be of analytical reagent quality.

The water used must be distilled or water of equivalent purity.

3.1 Chemicals

3.1.1 Sodium tungstate dihydrate, $\text{Na}_2\text{WO}_4 \cdot 2\text{H}_2\text{O}$ (CAS Number: 10213-10-2);

3.1.2 Sodium molybdate dihydrate, $\text{Na}_2\text{MoO}_4 \cdot 2\text{H}_2\text{O}$ (CAS Number: 10102-40-6);

3.1.3 Phosphoric acid solution 85 wt. % in H_2O , H_3PO_4 , $\rho_{20} = 1.71$ g/ml (CAS Number 7664-38-2);

3.1.4 Hydrochloric acid, HCl , $\rho_{20} = 1.2$ g/ml (CAS Number 7647-01-0);

3.1.5 Lithium sulfate monohydrate, $\text{Li}_2\text{SO}_4 \cdot \text{H}_2\text{O}$ (CAS Number: 10102-25-7);

3.1.6 Bromine, Br_2 (CAS Number: 7726-95-6);

3.1.7 Sodium carbonate anhydrous, Na_2CO_3 (CAS Number: 497-19-8);

3.1.8 Activated charcoal decolorizing (CAS Number 7440-44-0).

3.2. Folin-Ciocalteu reagent

This reagent is available commercially in a form ready for use.

It may be prepared as follows: dissolve 100 g of sodium tungstate ($\text{Na}_2\text{WO}_4 \cdot 2\text{H}_2\text{O}$) and 25 g of sodium molybdate ($\text{Na}_2\text{MoO}_4 \cdot 2\text{H}_2\text{O}$) in 700 ml of distilled water. Add 50 ml of 85 % phosphoric acid ($\rho_{20} = 1.71$ g/ml) and 100 ml of concentrated hydrochloric acid ($\rho_{20} = 1.19$ g/ml). Bring to the boil and boil for 10 hours under reflux conditions. Then add 150 g of lithium sulphate ($\text{Li}_2\text{SO}_4 \cdot \text{H}_2\text{O}$) and a few drops of bromine and boil once more for 15 minutes. Allow to cool and make up to one liter with distilled water.

3.3. Anhydrous sodium carbonate, Na_2CO_3 , made up into a 20 % w/v solution.

4. APPARATUS

Normal laboratory apparatus, particularly:

- 4.1. 100 ml volumetric flasks.
- 4.2. Spectrophotometer capable of operating at 750 nm.
- 4.3. Technical balance (± 0.01 g)
- 4.4. 50 ml graduated cylinder;
- 4.5. 50 ml beaker;
- 4.6. Magnetic stirrer;
- 4.7. Rapid-filtration filter papers;
- 4.8. 5 ml calibrated pipette;
- 4.9. Optical-glass cuvette;
- 4.10 Ultrasonic bath

5. PROCEDURE

Good repeatability of results is achieved by using scrupulously clean apparatus (volumetric flasks and spectrophotometer cells).

5.1. Preparation of sample

Let P = percentage (m/m) of total sugars in the rectified concentrated must.

Dilute the RCM with distilled water until a total sugar concentration of the solution equal to 25 ± 0.5 % (m/m) (25° Brix): weigh a mass in g equal to $2500/P$ into a volumetric flask (4.1) and make up to 100 g with water.

5.2. Preparation of a blank sample

Take 10 ml from solution 5.1 using the graduated cylinder (4.4), put into a 50 ml beaker (4.5) and add 0,5g of activated carbon (3.1.8).

Leave in contact for 15 minutes with the aid of a magnetic stirrer (4.6), and then filter the solution through a rapid-filtration paper (4.7).

5.3. Color reaction

5.3.1 Color development in the sample

Introduce the following reagents or solutions into a 100 ml volumetric flask (4.1) strictly in the order given below:

- 5 ml of the sample (5.1) using a pipette (4.8),
- 50 ml of distilled water by means of a graduated cylinder (4.4),
- 5 ml of Folin-Ciocalteu reagent (3.2) using a pipette (4.8),
- 20 ml of sodium carbonate solution (3.2) by means of a graduated cylinder (4.4).

Make up to 100 ml with distilled water. Stir to homogenize. Wait 30 minutes for the reaction to stabilize.

During this period the flasks should be put in an ultrasonic bath (4.10) for 15 minutes to remove any bubbles that may interfere in the spectrophotometric measurement.

5.3.2 Color development in blank

Proceed as described in (5.3.1) by replacing the sample (5.1) with a blank (5.2).

5.4. Measurement

Determine the absorbance at 750 nm through an optical-glass cuvette with a path length of 1 cm, with respect to a blank (5.2).

If the absorbance is not around 0.3 an appropriate dilution should be made until the measured absorbance falls to around 0.3.

6. EXPRESSION OF RESULTS

6.1. Method of calculation

The result is expressed in the form of an index obtained by multiplying the absorbance by 16, with one decimal point.

The FCI value calculated should be corrected for the blank according to the following formula:

$$\text{FCI measured at } 25^{\circ}\text{Brix} = 16 d (A - A_{\text{blank}})$$

where:

A = absorbance at 750 nm measured on the sample at 25 ± 0.5 % (m/m)

(5.1)

A_{blank} = absorbance at 750 nm measured on the blank (5.2)

d = an appropriate factor if a dilution has been done (5.4)

7. METHOD PERFORMANCE

The method was checked in the ICQRF laboratory in Conegliano (Italy) analyzing two RCM samples. Each sample was further enriched in SO₂ at a concentration 5 mg/Kg TS (mg per Kg of total sugar). The samples were analyzed three times:

Samples	FC index at 25°Brix			Media	SD	r=2.8xSD
RCM 1	5.4	4.9	5.3	5.2	0.3	0.8
RCM 2	2.2	2.4	1.9	2.2	0.2	0.7

Further data was provided from the ASAE laboratory (Portugal):

Number of samples	Concentration range	Sr	r	SR	R
21	From 1 to 5.3	0.25	0.7		
21	From 1 to 5.0			0.91	2.5

Annex G

**Grape juice, reconstituted grape juice,
concentrated grape juice, and grape
nectar**

**COMPENDIUM OF INTERNATIONAL ANALYSIS OF METHODS - OIV
Measuring Ochratoxin A in grape juice, reconstituted grape juice,
concentrated grape juice, and grape nectar, after going through
an immunoaffinity column and high liquid performance
chromatography with fluorescence detection**

Method OIV-MA-G1-01

Type IV method

**Measuring Ochratoxin A in grape juice, reconstituted grape
juice, concentrated grape juice, and grape nectar, after going
through an immunoaffinity column and high liquid
performance chromatography with fluorescence detection
(OIV-OENO 662A-2022)**

1. Scope

This document describes the method used for determining ochratoxin A (OTA) in grape juice, reconstituted grape juice, concentrated grape juice, and nectar in concentrations ranging from 0.2 µg/L up to 10 µg/L.

2. Principle

This method use immunoaffinity column and high performance liquid chromatography (HPLC).

OTA is eluted with methanol and quantified by HPLC in reverse phase with fluorimetric detection.

3. Reagents and materials

3.1. Reagents for separation of the OTA on an immunoaffinity column. The reagents listed below are examples. Suppliers of immunoaffinity columns may offer dilution solutions and eluents suitable for their products. If so, it is preferable to use these products.

3.1.1. Sodium hydrogen phosphate dihydrate ($\text{Na}_2\text{HPO}_4 \cdot 2\text{H}_2\text{O}$) CAS [10028-24-7].

3.1.2. Sodium dihydrogen phosphate monohydrate ($\text{NaH}_2\text{PO}_4 \cdot \text{H}_2\text{O}$) CAS [10049-21-5].

3.1.3. Sodium chloride (NaCl) CAS [7647-14-5].

3.1.4. Purified water for laboratories, for example EN ISO 3696 quality.

3.1.5. Phosphate buffer (dilution solution).

Dissolve 60.0 g of $\text{Na}_2\text{HPO}_4 \cdot 2\text{H}_2\text{O}$ (3.1.1) and 8.8 g of $\text{NaH}_2\text{PO}_4 \cdot \text{H}_2\text{O}$ (3.1.2) in 950 mL of water (3.1.4) and add more water to make up to 1 litre.

3.1.6. Phosphate buffer saline (washing solution).

**COMPENDIUM OF INTERNATIONAL ANALYSIS OF METHODS - OIV
Measuring Ochratoxin A in grape juice, reconstituted grape juice,
concentrated grape juice, and grape nectar, after going through
an immunoaffinity column and high liquid performance
chromatography with fluorescence detection**

Dissolve 2.85 g of $\text{Na}_2\text{HPO}_4 \cdot 2\text{H}_2\text{O}$ (3.1.1), 0.55 g of $\text{NaH}_2\text{PO}_4 \cdot \text{H}_2\text{O}$ (3.1.2) and 8.70 g of NaCl (3.1.3) in 950 mL of water (3.1.4) and add more water to make up to 1 litre.

3.1.7. Methanol (≥ 99.9 % purity) (CH_3OH) CAS [67-56-1].

3.2. Reagents for HPLC

3.2.1. Acetonitrile for HPLC (CH_3CN) CAS [75-05-8].

3.2.2. Acetic acid (100 % purity) (CH_3COOH) CAS [64-19-7].

3.2.3. Mobile phase: water: acetonitrile: acetic acid, 99 : 99 : 2, v/v/v (approximate proportions).

Mix 990 ml of water (3.1.4) with 990 mL of acetonitrile (3.2.1) and 20 mL of acetic acid (3.2.2). In the presence of undissolved components, filter through a 0.45 μm filter. Degas (with helium, for example) unless the HPLC equipment used includes a degassing step.

3.3. Reagents for the preparation of the OTA stock solution

3.3.1. Toluene ($\text{C}_6\text{H}_5\text{CH}_3$) CAS [108-88-3].

3.3.2. OTA (≥ 99.5 % purity) CAS [303-47-9].

3.3.3. Solvent mixture (toluene: acetic acid, 99 : 1, v/v)

Mix 99 parts in volume of toluene (3.3.1) with one part volume of acetic acid (3.2.2).

A commercial solution of standard concentration (around 50 $\mu\text{g}/\text{mL}$), with an analysis certificate stating the reference value and uncertainty of the concentration it is of preferential use than the use of OTA in solid form.

3.4. OTA stock solution

Dissolve 1 mg of OTA or the same content in a bulb, if the OTA was obtained in the form of film after evaporation, in the solvent mixture (3.3.3) to obtain a solution containing approximately 20 to 30 $\mu\text{g}/\text{mL}$ of OTA.

To determine the exact concentration (if necessary), record the absorption spectrum between 300 and 370 nm in a quartz space with 1 cm of optical path while using the solvent mixture (3.3.3) as a blank. Identify maximum absorption and calculate the concentration of OTA (COTA) in $\mu\text{g}/\text{mL}$ by using the following equation:

**COMPENDIUM OF INTERNATIONAL ANALYSIS OF METHODS - OIV
Measuring Ochratoxin A in grape juice, reconstituted grape juice,
concentrated grape juice, and grape nectar, after going through
an immunoaffinity column and high liquid performance
chromatography with fluorescence detection**

$$C_{OTA} = A_{MAX} \times M \times 100 / \epsilon \times \delta$$

In which:

A_{MAX} = Absorption determined by the longest maximum wave (about 333 nm);

M = OTA molecular mass = 403.8 g/mol;

ϵ = OTA molar extinction coefficient in the solvent mixture (3.3.3) ($\epsilon = 544 \text{ m}^2/\text{mol}$);

δ = optical pathway (cm).

This solution is stable at -18 °C for at least 4 years.

Standard OTA solution 2 µg/mL (toluene: acetic acid, 99 : 1, v/v)

Dilute the stock solution (3.4) with the solvent mixture (3.3.3) to obtain a standard solution of OTA with a concentration of 2 µg/mL.

This solution can be stored at 4 °C in a refrigerator. The stability should be tested in use.

4. Apparatus

Usual laboratory equipment and in particular, the following equipment:

- 4.1. Glass tubes (4 mL).
- 4.2. Analytical balance.
- 4.3. Volumetric flasks.
- 4.4. Volumetric pipettes.
- 4.5. Micropipettes.
- 4.6. Solid Phase Extraction (SPE) system for immunoaffinity columns.
- 4.7. Reservoir and flow tube adapted to immunoaffinity columns.
- 4.8. Glass microfiber filters.
- 4.9. Immunoaffinity columns specifically for OTA.

The column should have the total link capacity of at least 100 ng OTA. This will allow for a purification yield of at least 85 % when a diluted solution of the sample containing 100 ng OTA is passed through.

**COMPENDIUM OF INTERNATIONAL ANALYSIS OF METHODS - OIV
Measuring Ochratoxin A in grape juice, reconstituted grape juice,
concentrated grape juice, and grape nectar, after going through
an immunoaffinity column and high liquid performance
chromatography with fluorescence detection**

- 4.10. Liquid chromatograph, with a pump for the mobile phase capable of achieving a constant flow rate of 1 mL/min isocratic. Injection system must be equipped with 100 µl loop.
- 4.11. Column of analytical HPLC in steel 150 × 4.6 mm (i.d.) filled with a stationary phase C18 (5 µm) preceded with a pre-column or a pre-filter (0.5 µm) containing an appropriate phase. Different size columns can be used provided that they guarantee a good base line and background noise enabling the detection of OTA peaks, among others.
- 4.12. Fluorescence detector is connected to the column and the excitation wavelength is set at 333 nm and the emitting wavelength at 460 nm.
- 4.13. Information retrieval system.
- 4.14. U.V. spectrophotometer.

5. Preparations of samples (given as example)

5.1. For grape juice, reconstituted grape juice, and nectar

Pour 10 ml of the sample in a 100 mL conical flask. Add 10 mL of the dilution solution (3.1.5). Mix vigorously. Filter through glass microfibre filter (4.8). Filtration is necessary for cloudy solutions or when there is precipitation after dissolving.

5.2. For concentrated grape juice

First, dilute the juices five times (m/m) with water (3.1.4). Consider this dilution in the final calculation of the OTA concentration (item 8). Then, Pour 10 mL of the diluted sample in a 100 mL conical flask. Add 10 mL of the dilution solution (3.1.5). Mix vigorously. Filter through glass microfibre filter (4.8). Filtration is necessary for cloudy solutions or when there is precipitation after dissolving.

6. Procedure

6.1. Purification by immunoaffinity column (as an example)

Samples are diluted with a suitable solvent according to the instructions on the kit manufacturer. This solution is filtered and purified on an immunoaffinity column. Set up the immunoaffinity column (4.9) to the SPE system (4.6), and attach the reservoir (4.7)

Add 10 mL (equivalent to 5 mL of the sample) of the diluted solution in the reservoir. Put this solution through the immunoaffinity column at a flow of 1 drop per second.

**COMPENDIUM OF INTERNATIONAL ANALYSIS OF METHODS - OIV
Measuring Ochratoxin A in grape juice, reconstituted grape juice,
concentrated grape juice, and grape nectar, after going through
an immunoaffinity column and high liquid performance
chromatography with fluorescence detection**

The immunoaffinity column should not become dry. Wash the immunoaffinity column with 5 mL of washing solution (3.1.6) and then with 5 ml of water (3.1.4) at a flow of 1 to 2 drops per second. Blow air through to dry column. Elute OTA in a glass tube (4.1) with 2 mL of methanol (3.1.7) at the rate of 1 drop per second. Evaporate the eluate to dryness at 50 °C with nitrogen. Dissolve again immediately in 250 µl of the HPLC mobile phase (3.2.3) and keep at 4 °C until the HPLC analysis.

6.2. HPLC analysis

Using the injection loop, inject 100 µl of reconstituted extract in the chromatography.

Operating conditions (as an example)

Flow: 1 mL/min.

Mobile phase: acetonitrile: water: acetic acid (99 : 99 : 2, v/v/v) (3.2.3)

Fluorescence detector: Excitation wavelength = 333 nm

Emitting wavelength = 460 nm

Volume of injection: 100 µL

7. **Quantification of ochratoxin A (OTA)**

The quantification of OTA should be calculated by measuring the area or the height of the peaks at the OTA retention time and compared to the calibration curve.

7.1. Calibration curve (as an example)

Prepare a calibration curve daily or every time chromatographical conditions change. Measure out 0.5 mL of the standard OTA solution (3.5) at 2 µg/mL in a glass tube (4.1) and evaporate the solvent using nitrogen. Dissolve again in 10 mL in the HPLC mobile phase (3.2.3) which was previously filtered using a 0.45 µm filter. This produces an OTA solution of 100 µg/L. Prepare at least 6 HPLC calibration solutions in five 5 mL calibrated volumetric flasks following Table 1 (as an example).

Complete each 5 mL standard solution with HPLC mobile phase (3.2.3).

Inject 100 µL of each solution in the HPLC.

Table 1. Calibration curve

**COMPENDIUM OF INTERNATIONAL ANALYSIS OF METHODS - OIV
Measuring Ochratoxin A in grape juice, reconstituted grape juice,
concentrated grape juice, and grape nectar, after going through
an immunoaffinity column and high liquid performance
chromatography with fluorescence detection**

Calibration standards	Std 1	Std 2	Std 3	Std 4	Std 5	Std 6
µL of mobile phase filtered HPLC (3.2.3)	4990	4975	4950	4900	4770	4500
µL of OTA solution at 100 µg/L	10	25	50	100	250	500
OTA concentration (µg/L)	0.2	0.5	1.0	2.0	5.0	10
Injected OTA (ng)	0.02	0.05	0.10	0.20	0.50	1.00

NOTES:

If the quantity of OTA in the samples is outside the calibration range, an appropriate dilution should occur. In these cases, the calculation of the final concentration (8) should be reviewed on a case by case basis.

Check in the Guide to the critical points of the method of measuring ochratoxin A by immunoaffinity column (appendix III- method OIV-MA-AS315-10).

8. Calculations

Calculate the quantity of OTA in the aliquot of the solution tested and injected in the HPLC column.

Calculate the concentration of OTA (C_{OTA}) in µg/L by using the following formula:

$$C_{OTA} = MA \times F / V_1 \times V_3 / V_2$$

Where:

MA is the mass of ochratoxin A (in µg) in the aliquot part of the template injected on the column and evaluated from the calibration curve.

F is the dilution factor

V₁ is the sample volume to be analysed (0.01 L)

V₂ the volume of the solution tested and injected in the column (100 µL)

V₃ is the volume of solution used to dissolve the dry eluate (250 µL)

COMPENDIUM OF INTERNATIONAL ANALYSIS OF METHODS - OIV Measuring Ochratoxin A in grape juice, reconstituted grape juice, concentrated grape juice, and grape nectar, after going through an immunoaffinity column and high liquid performance chromatography with fluorescence detection

The recovery rate of the immunoaffinity columns must be taken into consideration in the case of direct calibration by synthetic solutions.

9. Expression of the results

The amount of OTA is expressed in micrograms per liter ($\mu\text{g/L}$) with two significant figures taking into account uncertainty.

10. Characteristics of the method

An internal validation study was carried out for the purpose of assessing the suitability

of the method for grape juices, taking into account linearity, limits of detection and quantification and the accuracy of the method. The latter parameter was determined by defining the levels of precision and trueness of the method.

10.1. Linearity of the method

Based on the results obtained from the linear regression analysis, the method proved to be linear within the ranges shown in the Figure 1 and in the Table 2.

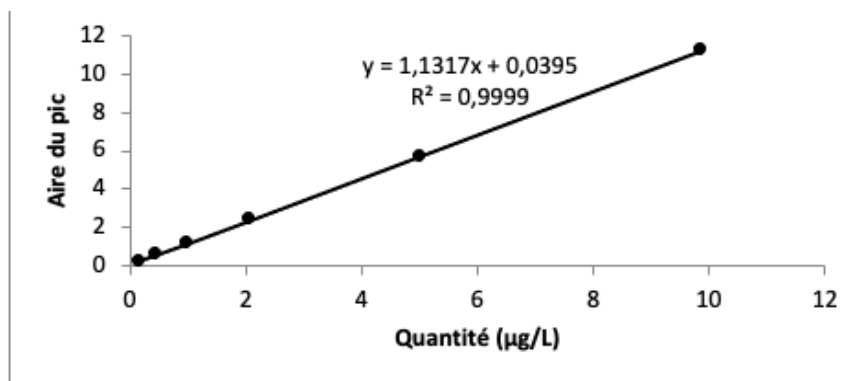

Figure 1. OTA calibration curve

**COMPENDIUM OF INTERNATIONAL ANALYSIS OF METHODS - OIV
Measuring Ochratoxin A in grape juice, reconstituted grape juice,
concentrated grape juice, and grape nectar, after going through
an immunoaffinity column and high liquid performance
chromatography with fluorescence detection**

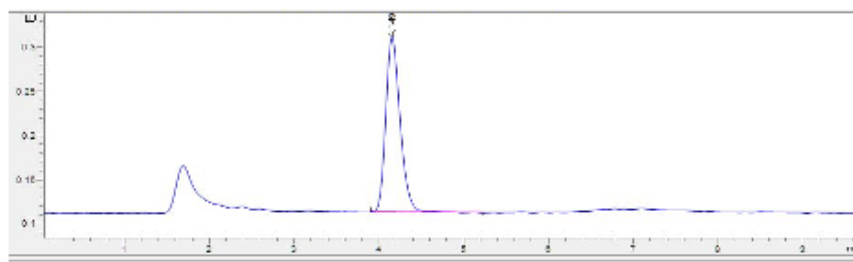

Figure 2. Chromatogram of 2.0 µg/L OTA standard

10.2. Limit of detection and limit of quantification

The detection limit (LD) and the limit of quantification (LoQ) were calculated from a series of 8 analytical repetitions of a grape juice spiked with 0.10 µg/L of OTA and is equal to 3 standard deviations for the LD and 10 standard deviations for the LoQ (Table 2).

10.3. Precision of the method

The parameters taken into account were repeatability and reproducibility. Table 2 shows the values of these parameters. The repeatability was expressed as the relative standard deviation of measurements repeated in different concentrations found for grape juice. And the reproducibility was expressed as the average of the relative standard deviation of measurements of the same grape juice sample, made by different operators.

10.4. Trueness of the method

The percentage recovery was determined using a grape juice sample spiked in 6 concentrations levels of OTA, ranging from 0.10 µg/L to 10 µg/L. Each level was analyzed 5 times. An example of a recovery chromatogram is given in Figure 3.

**COMPENDIUM OF INTERNATIONAL ANALYSIS OF METHODS - OIV
Measuring Ochratoxin A in grape juice, reconstituted grape juice,
concentrated grape juice, and grape nectar, after going through
an immunoaffinity column and high liquid performance
chromatography with fluorescence detection**

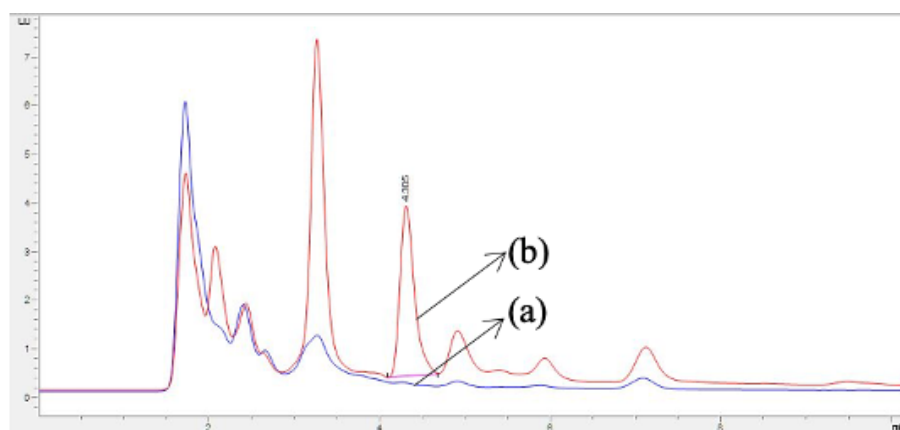

Figure 3. An example of a recovery chromatogram of a grape juice (a) and a grape juice spiked with 2 µg/L of OTA (b).

Table 2. Characteristics of the method.

Linearity range (µg/L)	Determination coefficient (r ²)	LD (µg/L)	LoQ (µg/L)	Repeatability (n=7) RSD%	Reproducibility (n=7) RSD%	Recovery (%)
0.20 - 10	0.9999	0.12	0.22	4.79	5.17	104.2 ± 2.9

11. Bibliography

- OIV. Compendium of International Methods of Analysis of Wines and Musts. Method OIV-MA-AS315-10.
- EN ISO 3696. Water for analytical laboratory use — Specification and test methods (ISO 3696:1995).

COMPENDIUM OF INTERNATIONAL ANALYSIS OF METHODS - OIV
Determination of volatile acidity in grape juice, reconstituted
grape juice, concentrated grape juice, and grape nectar

Method OIV-MA-G1-02

Type IV method

Determination of volatile acidity in grape juice, reconstituted
grape juice, concentrated grape juice, and grape nectar
(OIV-OENO 662C-2022)

1. Scope

This method applies to volatile acid determination in grape juice, reconstituted grape juice, concentrated grape juice, and grape nectar by titration, at the indicated concentrations ranging from 0.11 up to 1.09 g/L in acetic acid.

2. Definition

The volatile acidity is derived from the acids of the acetic series present in grape juice, reconstituted grape juice, concentrated grape juice, and grape nectar in its free state and combined as salts.

3. Principle

Volatile acids are separated from the grape juice, reconstituted grape juice, concentrated grape juice*, and grape nectar by steam distillation and titrated using sodium hydroxide solution of known concentration. The acidity of free and combined sulfur dioxide distilled under these conditions should be subtracted from the acidity of the distillate. The acidity of any sorbic acid, which may have been added to the grape juice, reconstituted grape juice, concentrated grape juice, and grape nectar must also be subtracted.

Note: Part of the salicylic acid used to stabilize the grape juices before analysis is present in the distillate. This must be determined and subtracted from the acidity as show on section 7.3.

4. Reagents and materials

4.1. Reagents

4.1.1. Tartaric acid 99.5 % (C₄H₆O₆) CAS [87-69-4].

4.1.2. Sodium hydroxide (NaOH) CAS [1310-73-2] solution 0.1 M.

4.1.3. Phenolphthalein 98 % (C₂₀H₁₄O₄) CAS [77-09-8].

4.1.4. Hydrochloric acid 37 % (HCl) CAS [7647-01-0].

4.1.5. Iodine (I₂) CAS [7553-56-2] solution 0.005 M.

COMPENDIUM OF INTERNATIONAL ANALYSIS OF METHODS - OIV
Determination of volatile acidity in grape juice, reconstituted
grape juice, concentrated grape juice, and grape nectar

- 4.1.6. Potassium iodide 99.0 % (KI) CAS [7681-11-0].
4.1.7. Starch (C₆H₁₀O₅)_n CAS [9005-84-9].
4.1.8. Sodium tetraborate 99.5 % (Na₂B₄O₇·10H₂O) CAS [1303-96-4].
4.1.9. Acetic acid 99.8 % (CH₃COOH) CAS [64-19-7] solution 0.1 M.
4.1.10. Lactic acid 85 % (C₃H₆O₃) CAS [50-21-5].
4.1.11. Sodium chloride 99.0 % (NaCl) [7647-14-5].
4.1.12. Sodium thiosulfate 99.5 % (Na₂S₂O₃·5H₂O) CAS [10102-17-7] solution 0.1 M or a commercial solution.
4.1.13. Iron (III) ammonium sulfate 99.0 % (Fe(NH₄)₂(SO₄)₂·12H₂O) CAS [7783-83-7] 10 % (m/v).
4.1.14. Sodium salicylate 99.5 % (NaC₇H₅O₃) CAS [54-21-7] solution 0.01 M.
4.1.15. Ethanol 96 % (C₂H₆O) CAS [64-17-5].
4.1.16. Water Type 1 (EN ISO 3696) or equivalent ultrapure.

4.2. Preparation of solutions

4.2.1. Phenolphthalein solution 1 % m/v

Mix 1 g of phenolphthalein (4.1.3) in 100 mL of ethanol (4.1.15).

Commercial solution can be used.

4.2.2. Starch indicator solution 5 g/L

Mix 5 g of starch (4.1.7) with about 500 mL of water (4.1.16). Bring to the boiling point, stirring continuously and boil for 10 min. Add 200 g of sodium chloride (4.1.11). When cool, complete to one liter of water (4.1.16).

4.2.3. Saturated solution of sodium tetraborate about 55 g/L

Mix 55 g of sodium tetraborate (4.1.8) in one liter of water (4.1.16).

4.2.4. Lactic acid solution 0.1 M - 90 g/L

Dilute 100 mL of lactic acid (4.1.10) in 400 mL of water (4.1.16). As an example, this solution is heated in an evaporating dish over a boiling water bath for four hours, topping up the volume occasionally with water (4.1.16). After cooling, complete to a liter of water (4.1.16). Titrate the lactic acid in 10 mL of sodium hydroxide solution (4.1.2). Adjust the concentration of the lactic acid solution for 90 g/L.

5. Apparatus

5.1. Steam distillation apparatus consisting of:

- a steam generator; the steam must be free of carbon dioxide;
- a flask with a steam pipe;

COMPENDIUM OF INTERNATIONAL ANALYSIS OF METHODS - OIV
Determination of volatile acidity in grape juice, reconstituted
grape juice, concentrated grape juice, and grape nectar

- a distillation column;
- a condenser.

This equipment must pass the three following tests:

(a) place 20 mL of distilled water free of CO₂ in the flask. Collect 250 mL of the distillate and add to it 0.1 mL of sodium hydroxide solution (4.1.2) and two drops of phenolphthalein solution (4.2.1). The pink coloration must be stable for at least 10 s (i.e. steam to be free of carbon dioxide);

(b) place 20 mL acetic acid solution (4.1.9), in the flask. Collect 250 mL of the distillate. Titrate with the sodium hydroxide solution (4.1.2) and two drops of phenolphthalein solution (4.2.1). The volume of the titer must be at least 19.9 mL (i.e. at least 99.5 % of the acetic acid entrained with the steam);

(c) place 20 mL lactic acid solution (4.2.4), in the flask. Collect 250 mL of the distillate and titrate the acid with the sodium hydroxide solution (4.1.2) and two drops of phenolphthalein solution (4.2.1). The volume of sodium hydroxide solution (4.1.2) added must be less than or equal to 1.0 mL (i.e. not more than 0.5 % of lactic acid is distilled).

Any apparatus (automated or not) or procedure, which passes these tests satisfactorily, fulfils the requirements of official international apparatus or procedures.

5.2. Volumetric material

5.3. Analytical balance verified and calibrated

5.4. Volumetric pipettes of 10 mL and 20 mL

5.5. Burette

5.6. Water bath

6. Procedure

6.1. Preparation of sample

For gasified grape juices to eliminate CO₂:

place about 50 mL of grape juice, reconstituted grape juice, and grape nectar in a vacuum flask; apply vacuum to the flask with the water pump for one to two minutes while shaking continuously. Other CO₂ elimination systems may be used if the CO₂ elimination is guaranteed.

6.2. Steam distillation

COMPENDIUM OF INTERNATIONAL ANALYSIS OF METHODS - OIV
Determination of volatile acidity in grape juice, reconstituted
grape juice, concentrated grape juice, and grape nectar

Place 20 mL of grape juice, reconstituted grape juice, concentrated grape juice* and grape nectar into the flask. Add about 0.5 g of tartaric acid (4.1.1). Collect at least 250 mL of the distillate.

* The concentrated grape juice must be diluted (200 g to 500 mL, for example) and multiply the result by the dilution factor ($F = 2.5$, in this case).

6.3. Titration

Titrate with the sodium hydroxide solution (4.1.2), using two drops of phenolphthalein solution (4.2.1) as indicator. Let n mL be the volume of sodium hydroxide solution (4.1.2) used. Add four drops the hydrochloric acid (4.1.4) dilute 1/4 (v/v) with water (4.1.16), 2 mL of starch solution (4.2.2) and a few crystals of potassium iodide (4.1.6). Titrate the free sulfur dioxide with the iodine solution (4.1.5). Let n' mL be the volume used. Add the saturated solution of sodium tetraborate (4.2.3) until the pink coloration reappears. Titrate the combined sulfur dioxide with the iodine solution (4.1.5). Let n'' mL be the volume used.

7. Calculation (Results)

7.1. Method of calculation

The volatile acidity, expressed in milliequivalents per liter to one decimal place, is given by:

$$\boxed{5(n - 0.1n' - 0.05n)}$$

The volatile acidity, expressed in grams of acetic acid per liter to two decimal places, is given by:

$$\boxed{0.30(n - 0.1n' - 0.05n'')}$$

n = volume (mL) of sodium hydroxide solution (4.1.2) used.

n' = volume (mL) of iodine solution (4.1.5) used on the titration of the free sulfur dioxide.

COMPENDIUM OF INTERNATIONAL ANALYSIS OF METHODS - OIV
Determination of volatile acidity in grape juice, reconstituted
grape juice, concentrated grape juice, and grape nectar

n'' = volume (mL) of iodine solution (4.1.5) used on the titration of the combined sulfur dioxide.

Note: In the case of the concentrated grape juice multiply the result by the dilution factor (F).

7.2. Samples with sorbic acid present

Since 96% of sorbic acid is steam distilled with a distillate volume of 250 mL, its acidity must be subtracted from the volatile acidity, knowing that 100 mg of sorbic acid corresponds to an acidity of 0.89 milliequivalents or 0.053 g of acetic acid and knowing the concentration of sorbic acid in mg/L as determined by other methods.

7.3. Samples with salicylic acid present

7.3.1. Identification of salicylic acid in the volatile acidity distillate

Immediately after the determination of the volatile acidity and the correction for free and combined sulfur dioxide, introduce into a conical flask 0.5 mL hydrochloric acid (4.1.4), 3 mL of the sodium thiosulfate solution (4.1.12) and 1 mL of the iron (III) ammonium sulfate solution (4.1.13). If salicylic acid is present, a violet coloration appears.

7.3.2. Determination the salicylic acid

On the above conical flask, indicate the volume of the distillate by a reference mark. Empty and rinse the flask. Subject a new test sample of 20 mL grape juice or reconstituted grape juice or concentrated grape juice (see section 6.2) or nectar to steam distillation and collect the distillate in the conical flask up to the reference mark. Ensure that the same volume of distillate is collected as in section 7.3.3. Add 0.3 mL hydrochloric acid (4.1.4) and 1 mL of the iron (III) ammonium sulfate solution (4.1.13). The contents of the conical flask turn violet. Into a conical flask identical to that carrying the reference mark, introduce distilled water (4.1.16) up to the same level as that of the distillate. Add 0.3 mL hydrochloric acid (4.1.4) and 1 mL of the iron (III) ammonium sulfate solution (4.1.13). Titrate the distillate water in the conical flask with sodium salicylate solution (4.1.14) until the violet coloration obtained has the same intensity as that of the conical flask containing the wine distillate. Let n''' mL be the volume of solution added from the burette.

7.3.3. Correction to the volatile acidity

Subtract the volume $0.1 \times n'''$ mL from the volume n mL of sodium hydroxide solution (4.1.2) used to titrate the acidity of the distillate during the determination of volatile acidity.

COMPENDIUM OF INTERNATIONAL ANALYSIS OF METHODS - OIV
Determination of volatile acidity in grape juice, reconstituted
grape juice, concentrated grape juice, and grape nectar

8. Indicative characteristics of the method

A validation study with grape juice was carried out for the purpose of assessing the suitability of the method for the matrices in question, taking into account linearity, limits of detection and quantification and the accuracy of the method. The latter parameter was determined by defining the levels of precision and trueness of the method.

8.1. Linearity of the method

The method proved to be linear within the ranges 0.11 g/L – 1.09 g/L shown in the Table 1.

8.2. Limit of detection and limit of quantification

The detection limit (LD) and limit of quantification (LoQ) were calculated from 7 analytical repetitions of an 0.11 g/L aqueous acetic acid solution and is equal to 3 standard deviations for the LD and 10 standard deviations for the LoQ (Table 1).

8.3. Precision of the method

The parameters taken into account were repeatability and reproducibility. Table 1 shows the values of these parameters. The repeatability was expressed as Relative Standard Deviation (%RSD) of measurements repeated in different concentrations found for grape juice. And the reproducibility was expressed as the average of the Relative Standard Deviation (%RSD) of measurements made of the same grape juice sample, by different operators.

8.4. Trueness of the method

The percentage recovery was determined using a grape juice sample spiked in 6 different levels of acetic acid, ranging from 0.11 g/L to 1.09 g/L.

Table 1. Characteristics of the method

Linearity range (g/L of acetic acid)	Correlation coefficient (r^2)	LD (g/L of acetic acid)	LoQ (g/L of acetic acid)	Repeatability (n = 7) %RSD	Reproducibility (n = 7) %RSD	Average recovery (%)
0.11 – 1.09	0.9905	0.09	0.16	2.75	3.15	103.63

9. Bibliography

COMPENDIUM OF INTERNATIONAL ANALYSIS OF METHODS - OIV
Determination of volatile acidity in grape juice, reconstituted
grape juice, concentrated grape juice, and grape nectar

- OIV. Compendium of International Methods of Analysis of Wines and Musts. Method OIV-MA-AS313-02:R2015.
- BS EN ISO 3696, Water for analytical laboratory use — Specification and test methods, 1995.

Method OIV-MA-G1-03

Method Type IV

Method for ¹⁸O/¹⁶O isotope ratio determination of water in
grape juice
(OIV-OENO 662H-2022)

1. Scope

The method describes the determination of the isotopic ratio ¹⁸O/¹⁶O of water from grape juice after equilibration with CO₂, using the isotope ratio mass spectrometry.

2. Definitions

Oxygen isotopic ratio ¹⁸O/¹⁶O has been used to identify the water added in the grape juice.

3. Principle

The method is based on the equilibration of water from the grape juice with CO₂, according to the following isotopic exchange reaction:

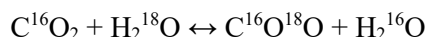

After equilibration the carbon dioxide in the gaseous phase is used for analysis by means of Isotopic Ratio Mass Spectrometry (IRMS) where the ¹⁸O/¹⁶O isotopic ratio is determined on the CO₂ resulting from the equilibration.

4. Reagents and materials

The materials and consumables depend on the method used. The systems generally used are based on the equilibration of water in grape juice with CO₂.

The following reference materials, working standards and consumables can be used:

4.1. Reference materials

COMPENDIUM OF INTERNATIONAL ANALYSIS OF METHODS - OIV
Method for 18O/16O isotope ratio determination of water in
grape juice

<u>NAME</u>	<u>Issued by</u>	<u>δ¹⁸O related to V-SMOW</u>
<u>VSMOW2</u>	<u>NIST/IAEA</u>	0 ‰
<u>GISP</u>	<u>NIST</u>	-24.78 ‰
<u>SLAP</u>	<u>NIST/IAEA</u>	-55.5 ‰

4.2. Working Standards

4.2.1. Carbon dioxide used for equilibration in the case of continuous flow systems cylinders containing gas mixture helium-carbon dioxide can also be used).

4.2.2. Working Standards with calibrated δ¹⁸O VSMOW values traceable to international reference materials.

4.3. Consumables

- Helium for analysis (CAS 07440-59-7);
- Carbon dioxide for analysis, used as a reference gas (CAS 00124-38-9);

5. Apparatus

The equipment and interfaces depend on the method and can be used as follow

5.1. Isotope Ratio Mass Spectrometer (IRMS)

Isotope ratio mass spectrometer (IRMS) is able for determining the relative ¹⁸O content of CO₂ naturally occurring with an internal accuracy of 0.05 ‰ or better expressed as a relative value. The mass spectrometer used to measure isotope ratios is generally equipped with a triple collector to simultaneously measure intensities for m/z = 44, 45 and 46.

5.2. Equipment and Materials

The equipment and materials used must meet stated requirements of the used method/apparatus (as specified by the manufacturer). However, all equipment and materials can be replaced by items with similar performance.

5.2.1. Vials with septa appropriate for the used system;

5.2.2. Volumetric pipettes with appropriate tips;

5.2.3. Temperature controlled system to carry out the equilibration at constant temperature, typically within ± 1 °C;

5.2.4. Vacuum pump (if needed for the used system);

5.2.5. Autosampler (if needed for the used system);

COMPENDIUM OF INTERNATIONAL ANALYSIS OF METHODS - OIV
Method for $^{18}\text{O}/^{16}\text{O}$ isotope ratio determination of water in
grape juice

- 5.2.6. Syringes for sampling (if needed for the used system);
- 5.2.7. GC Column to separate CO_2 from other elementary gases (if needed for the used system).
- 5.2.8. Water removal device (e.g. selective permeable membrane)

6. Sampling

Juice samples as well as a reference material are used for analysis without any pre-treatment. Possible fermentation must be avoided adding benzoic acid (or another anti fermentation product) or filtered by membrane with pore diameter of $0.22\ \mu\text{m}$.

7. Procedure

The descriptions that follow refer to procedures generally used for the determination of the $^{18}\text{O}/^{16}\text{O}$ isotopic ratios by means of equilibration of water with a CO_2 working standard and the subsequent measurement by IRMS. These procedures can be altered according to changes of equipment and instrumentation provided by the manufacturers as various kind of equilibration devices are available, implying various conditions of operation. Two main technical procedures can be used for introduction of CO_2 into the IRMS either through a dual inlet system or using a continuous flow system. The technical systems and the corresponding operation conditions are given as an example

Note: all values given for volumes, temperatures, pressures and time periods are only indicative. Appropriate values must be obtained from specifications provided by the manufacturer and/or determined experimentally.

7.1. Manual equilibration

A defined volume of the sample/standard is transferred into a flask using a pipette.

The flask is then attached tightly to the manifold.

Each manifold is cooled down to below -80°C to deep-freeze the samples (manifold equipped with capillary opening tubes do not require this freezing step). Subsequently, the whole system is evacuated. After reaching a stable vacuum the gaseous CO_2 working standard is allowed to expand into the various flasks. For the equilibration process each manifold is placed in a temperature controlled water bath typically at 25°C ($\pm 1^\circ\text{C}$) for 12 hours (overnight). It is crucial that the temperature of the water-bath is kept constant and homogeneous.

After the equilibration process is completed, the resulting CO_2 is transferred from the flasks to the sample side bellow of the dual inlet system. The measurements are

COMPENDIUM OF INTERNATIONAL ANALYSIS OF METHODS - OIV
Method for $^{18}\text{O}/^{16}\text{O}$ isotope ratio determination of water in
grape juice

performed by comparing several times the ratios of the CO_2 contained in the sample side and the standard side (CO_2 reference standard gas) of the dual inlet.

This approach is repeated till the last sample of the sequence has been measured.

7.2. Use of an automatic equilibration apparatus

A defined volume of the sample/standard is transferred into a vial using a pipette.

The sample vials are attached to the equilibration system and cooled down to below -80°C to deep-freeze the samples (systems equipped with capillary opening tubes do not require this freezing step). Subsequently, the whole system is evacuated.

After reaching a stable vacuum the gaseous CO_2 working standard is expanded into the vials. Equilibrium is reached at a temperature of typically $22 \pm 1^\circ\text{C}$ after a minimum period of 5 hours and with moderate agitation (if available). Since the equilibration duration depends on various parameters (e.g. the vial geometry, temperature, applied agitation ...), the minimum equilibrium time should be determined experimentally.

After the equilibration process is completed, the resulting CO_2 is transferred from the vials to the sample side bellow of the dual inlet system. The measurements are performed by comparing several times the ratios of the CO_2 contained in the sample side and the standard side (CO_2 reference standard gas) of the dual inlet.

This approach is repeated till the last sample of the sequence has been measured.

7.3. Manual preparation manual and automatic equilibration and analysis with a dual inlet IRMS

A defined volume of sample / standard (eg. $200\ \mu\text{L}$) is introduced into a vial using a pipette. The open vials are then placed in a closed chamber filled with the CO_2 used for equilibration (4.2.1). After several purges to eliminate any trace of air, the vials are closed and then placed on the thermostated plate of the sample changer. The equilibration is reached after at least 8 hours at 40°C . Once the process of equilibration completed, the CO_2 obtained is dried and then transferred into the sample side of the dual inlet introduction system. The measurements are performed by comparing several times the ratios of the CO_2 contained in the sample side and the standard side (CO_2 reference standard gas) of the dual inlet.

This approach is repeated till the last sample of the sequence has been measured.

COMPENDIUM OF INTERNATIONAL ANALYSIS OF METHODS - OIV
Method for ¹⁸O/¹⁶O isotope ratio determination of water in
grape juice

7.4. Use of an automatic equilibration apparatus coupled to a continuous flow system

A defined volume of the sample/standard is transferred into a vial using a pipette.

The sample vials are placed into a temperature controlled tray.

Using a gas syringe the vials are flushed with mixture of He and CO₂. The CO₂ remains in the headspace of the vials for equilibration.

The temperature and the time for equilibration should be specified according to the manufacturer and/or determined experimentally. The equilibrium is normally reached at a temperature typically of 25 ± 1 °C after a minimum period of 18 hours.

After the equilibration process is completed, the resulting CO₂ is transferred by means of the continuous flow system into the ion source of the mass spectrometer.

CO₂ reference gas is also introduced into the IRMS by means of the continuous flow system. The measurement is carried out according to a specific protocol for each kind of equipment.

8. Calculation

The intensities for m/z = 44, 45, 46 are recorded for each sample and reference materials analysed. The ¹⁸O/¹⁶O isotope ratios are then calculated by the computer and the software of the IRMS instrument. In practice the ¹⁸O/¹⁶O isotope ratios are measured against a working standard previously calibrated against the V-SMOW. Small variations may occur while measuring online due to changes in the instrumental conditions. In such a case the δ¹⁸O of the samples must be corrected according to the difference in the δ¹⁸O value from the working standard and its assigned value, which was calibrated beforehand against V-SMOW. Between two measurements of the working standard, the variation is the correction applied to the sample results that may be assumed to be linear. Indeed, the working standard must be measured at the beginning and at the end of all sample series. Therefore, a correction can be calculated for each sample using linear interpolation between two values (the difference between the assigned value of the working standard and the measurements of the obtained values).

$$\delta^{18}O_{V-SMOW} = \left[\frac{\left(\frac{^{18}O}{^{16}O}\right)_{sample} - \left(\frac{^{18}O}{^{16}O}\right)_{V-SMOW}}{\left(\frac{^{18}O}{^{16}O}\right)_{V-SMOW}} \right] \times 1000 [‰]$$

COMPENDIUM OF INTERNATIONAL ANALYSIS OF METHODS - OIV
Method for 18O/16O isotope ratio determination of water in
grape juice

The $\delta^{18}\text{O}$ value normalized versus the V-SMOW/SLAP scale is calculated using the following equation:

$$\delta^{18}\text{O}_{V\text{-SMOW/SLAP}} = \frac{\delta^{18}\text{O}_{\text{échantillon}} - \delta^{18}\text{O}_{V\text{-SMOW}}}{\delta^{18}\text{O}_{V\text{-SMOW}} - \delta^{18}\text{O}_{\text{SLAP}}} \times 55,5[\%]$$

9. Characteristics of the method

A validation study was carried out for the purpose of assessing the suitability of the method for the matrices in question, taking into account linearity, limits of detection and quantification and the accuracy of the method. The latter parameter was determined by defining the levels of precision and trueness of the method.

9.1. Precision of the method

The parameters taken into account were repeatability and intralaboratory reproducibility. Table 1 shows the values of these parameters. The repeatability was expressed as ‰ of measurements repeated in the same conditions and in the same day for all the grape juice. And the reproducibility was expressed as the average of a ‰ of measurements of the same grape juice sample, made by two operators.

9.2. Trueness of the method

The recovery percentage was determined using a grape juice sample spiked with 6 concentrations of tap water, ranging from 20% to 99.5%. Each level was analyzed 5 times. The trueness was also expressed in terms of bias using a reference material and calculating the relative error.

Table 1. Characteristics do the method

Correlation coefficient (R2)	Repeatability (n=16) ‰	Reproducibility (n=7) ‰	Recovery (%) \pm SD	Trueness (RM) (‰)

COMPENDIUM OF INTERNATIONAL ANALYSIS OF METHODS - OIV
Method for $^{18}\text{O}/^{16}\text{O}$ isotope ratio determination of water in
grape juice

0.998	0.20	0.29	101 ± 2.16	0.17
-------	------	------	----------------	------

10. Bibliography

- OIV. Method for $^{18}\text{O}/^{16}\text{O}$ isotope ratio determination of water in wines and must. Method OIV-MA-AS2-12.

**HORIZONTAL METHOD FOR THE
ENUMERATION OF COLIFORMS —
COLONY-COUNT TECHNIQUE
(OIV-OENO 662M-2023)**

Foreword

ISO (the International Organization for Standardization) is a worldwide federation of national standards bodies (ISO member bodies). The work of preparing International Standards is normally carried out through ISO technical committees. Each member body interested in a subject for which a technical committee has been established has the right to be represented on that committee. International organizations, governmental and non-governmental, in liaison with ISO, also take part in the work. ISO collaborates closely with the International Electrotechnical Commission (IEC) on all matters of electrotechnical standardization.

International Standards are drafted in accordance with the rules given in the ISO/IEC Directives, Part 2.

The main task of technical committees is to prepare International Standards. Draft International Standards adopted by the technical committees are circulated to the member bodies for voting. Publication as an International Standard requires approval by at least 75 % of the member bodies casting a vote.

Attention is drawn to the possibility that some of the elements of this document may be the subject of patent rights. ISO shall not be held responsible for identifying any or all such patent rights.

ISO 4832 was prepared by Technical Committee ISO/TC 34, Food products, Subcommittee SC 9, Microbiology.

This third edition of ISO 4832 cancels and replaces ISO 4832:1991 and ISO 5541-1:1986. The main changes are follows:

- the alternative procedure of incubation at 35 LC has been deleted (see 4.2);
- a confirmation test in brilliant green lactose bile broth has been introduced (see 5.4 and 9.4).

Considering the nature of the changes to the previous edition of this International Standard, it is considered that the validation of alternative methods based on ISO 4832:1991 is not affected by this revision.

Introduction

**COMPENDIUM OF INTERNATIONAL ANALYSIS OF METHODS - OIV
Horizontal method for the enumeration of coliforms- Colony-
count technique)**

Because of the large variety of food and feed products, this horizontal method may not be appropriate in every detail for certain products. In this case, different methods which are specific to these products may be used if absolutely necessary for justified technical reasons. Nevertheless, every attempt should be made to apply this horizontal method as far as possible.

When this International Standard is next reviewed, account will be taken of all information then available regarding the extent to which this horizontal method has been followed and the reasons for deviations from this method in the case of particular products.

The harmonization of test methods cannot be immediate, and for certain groups of products International Standards and/or national standards may already exist that do not comply with this horizontal method. It is hoped that when such standards are reviewed, they will be changed to comply with this International Standard so that eventually the only remaining departures from this horizontal method will be those necessary for well-established technical reasons.

The technique described in this International Standard is more precise than that described in ISO 4831[1], but does not allow a microbiological examination to be carried out on such a large test portion. It is therefore the preferred method when large numbers of coliforms are present. Moreover, since the definition of “coliforms” adopted in the two documents is different, the microorganisms enumerated are not necessarily the same. For any particular product, the method to be chosen will be specified in the International Standard dealing with that product.

For the purposes of a practicable test method, the definition of “coliforms” given in Clause 3 and used as the basis for the procedure is not necessarily identical to corresponding definitions given in other published texts. The method described in this International Standard will, on average, detect only about 90 % of strains of the microorganisms referred to in other publications as “(presumptive) coliforms” (e.g. certain strains of *Citrobacter*, *Enterobacter*, *Klebsiella*) (see Reference [2]).

1. Scope

This International Standard gives general guidelines for the enumeration of coliforms. It is applicable to

- products intended for human consumption and for the feeding of animals, and
- environmental samples in the area of food production and food handling, by means of the technique of counting colonies after incubation on a solid medium at 30 °C or at 37 °C.

NOTE The temperature is subject to agreement between the parties concerned. In the case of milk and milk products, the temperature of incubation is 30 °C.

COMPENDIUM OF INTERNATIONAL ANALYSIS OF METHODS - OIV Horizontal method for the enumeration of coliforms- Colony- count technique)

This technique is recommended when the number of colonies sought is expected to be more than 100 per millilitre or per gram of the test sample.

2. Normative references

The following referenced documents are indispensable for the application of this document. For dated references, only the edition cited applies. For undated references, the latest edition of the referenced document (including any amendments) applies.

- ISO 6887 (all parts), Microbiology of food and animal feeding stuffs — Preparation of test samples, initial suspension and decimal dilutions for microbiological examination
- ISO 7218:—1), Microbiology of food and animal feeding stuffs — General requirements and guidance for microbiological examinations
- ISO 8261, Milk and milk products — General guidance for the preparation of test samples, initial suspensions and decimal dilutions for microbiological examination
- ISO/TS 11133-1, Microbiology of food and animal feeding stuffs — Guidelines on preparation and production of culture media — Part 1: General guidelines on quality assurance for the preparation of culture media in the laboratory
- ISO/TS 11133-2:2003, Microbiology of food and animal feeding stuffs — Guidelines on preparation and production of culture media — Part 2: Practical guidelines on performance testing of culture media

3. Terms and definitions

For the purposes of this document, the following terms and definitions apply.

3.2. Coliforms

bacteria which, at the specified temperature (i.e. 30 °C or 37 °C, as agreed) form characteristic colonies in crystal violet neutral red bile lactose agar, and which in the confirmation test cause fermentation of lactose with the production of gas under the test conditions specified in this International Standard

Only informative sections of standards are publicly available. To view the full content, you will need to purchase the ISO standard.

Bibliography

**COMPENDIUM OF INTERNATIONAL ANALYSIS OF METHODS - OIV
Horizontal method for the enumeration of coliforms- Colony-
count technique)**

- [1] ISO 4831, Microbiology of food and animal feeding stuffs — Horizontal method for the detection and enumeration of coliforms — Most probable number technique
- [2] EDWARD, P.R. and EWING, W.H. Identification of Enterobacteriaceae 3rd edition, Burgess Publishing Company, Minneapolis, Minnesota, USA, 1972
- [3] COWELL and MORISETTI. J. Sci. Food Agric. 20, 1969, pp. 573
- [4] PITON and GRAPPIN. J. Assoc. Anal. Chem. 74, 1991, pp. 92-103
- [5] ALDRIDGE et al. Report of the Ministry of Agriculture, Fish and Food, Norwich, NR47UQ, 1993

Method OIV-MA-G1-05

Type IV method

**HORIZONTAL METHOD FOR THE
ENUMERATION OF BETA-
GLUCURONIDASE-POSITIVE Escherichia coli
(OIV-OENO 662N-2023)**

Foreword

ISO (the International Organization for Standardization) is a worldwide federation of national standards bodies (ISO member bodies). The work of preparing International Standards is normally carried out through ISO technical committees. Each member body interested in a subject for which a technical committee has been established has the right to be represented on that committee. International organizations, governmental and non-governmental, in liaison with ISO, also take part in the work. ISO collaborates closely with the International Electrotechnical Commission (IEC) on all matters of electrotechnical standardization.

International Standards are drafted in accordance with the rules given in the ISO/IEC Directives, Part 3.

Draft International Standards adopted by the technical committees are circulated to the member bodies for voting. Publication as an International Standard requires approval by at least 75 % of the member bodies casting a vote.

Attention is drawn to the possibility that some of the elements of this part of ISO 16649 may be the subject of patent rights. ISO shall not be held responsible for identifying any or all such patent rights.

International Standard ISO 16649-2 was prepared by Technical Committee ISO/TC 34, Food products, Subcommittee SC 9, Microbiology.

ISO 16649 consists of the following parts, under the general title Microbiology of food and animal feeding stuffs — Horizontal method for the enumeration of β -glucuronidase-positive Escherichia coli:

- Part 1: Colony-count technique at 44 °C using membranes and 5-bromo-4-chloro-3-indolyl β -D-glucuronide
- Part 2: Colony-count technique at 44 °C using 5-bromo-4-chloro-3-indolyl β -D-glucuronide
- Part 3: Most probable number technique

Part 2: Colony-count technique at 44 °C using 5-bromo-4-chloro-3-indolyl β -D-glucuronide

Introduction

Because of the large variety of food and feed products, this horizontal method may not be appropriate in every detail for certain products. In this case, different methods which are specific to these products may be used if absolutely necessary for justified technical reasons. Nevertheless, every attempt should be made to apply this horizontal method as far as possible.

When this part of ISO 16649 is next reviewed, account will be taken of all information then available regarding the extent to which this horizontal method has been followed and the reasons for deviations from this method in the case of particular products.

The harmonization of test methods cannot be immediate and, for certain groups of products, International Standards and/or national standards may already exist that do not comply with this horizontal method. It is hoped that when such standards are reviewed they will be changed to comply with this part of ISO 16649 so that eventually the only remaining departures from this horizontal method will be those necessary for well-established technical reasons.

This International Standard describes two horizontal methods (ISO 16649-1 and ISO 16649-2) for the enumeration of β -glucuronidase-positive *Escherichia coli*.

The user may choose either ISO 16649-1 or ISO 16649-2. Either part is for general application. However, ISO 16649-1 should be used for foodstuffs which may contain severely stressed cells.

1. Scope

This part of ISO 16649 specifies a horizontal method for the enumeration of β -glucuronidase-positive *Escherichia coli* in products intended for human consumption or for the feeding of animals. It uses a colony-count technique at 44 °C on a solid medium containing a chromogenic ingredient for detection of the enzyme β -glucuronidase.

WARNING — Strains of *Escherichia coli* which do not grow at 44 °C and, in particular, those that are β -glucuronidase negative, such as *Escherichia coli* O157, will not be detected.

2. Normative references

The following normative documents contain provisions which, through reference in this text, constitute provisions of this part of ISO 16649. For dated references, subsequent amendments to, or revisions of, any of these publications do not apply. However, parties to agreements based on this part of ISO 16649 are encouraged to investigate the possibility of applying the most recent editions of the normative documents indicated below. For undated references, the latest edition of the normative document referred to applies. Members of ISO and IEC maintain registers of currently valid International Standards.

- ISO 6887-1, Microbiology of food and animal feeding stuffs — Preparation of test samples, initial suspension and decimal dilutions for microbiological examination — Part 1: General rules for the preparation of the initial suspension and decimal dilutions.
- ISO 7218, Microbiology of food and animal feeding stuffs — General rules for microbiological examinations.

3. Terms and definitions

For the purposes of this part of ISO 16649, the following terms and definitions apply.

3.1. β -glucuronidase-positive Escherichia coli

bacteria which at 44 °C form typical blue colony on tryptone-bile-glucuronide medium (TBX) under the conditions specified in this part of ISO 16649

3.2. enumeration of β -glucuronidase-positive Escherichia coli

determination of the number of colony-forming units (CFU) of β -glucuronidase-positive Escherichia coli, per millilitre or per gram of sample, when test and calculations are carried out in accordance with this part of ISO 16649

Only informative sections of standards are publicly available. To view the full content, you will need to purchase the ISO Standard.

Bibliography

- [1] BLAZKO N. Evaluation of the β -glucuronidase substrate 5-bromo-4-chloro-3-indolyl- β -D-glucuronide in a 24 hour direct plating method for Escherichia coli. J. Food Protection, 51, p. 402.

COMPENDIUM OF INTERNATIONAL ANALYSIS OF METHODS - OIV
Horizontal method for the enumeration of beta- Glucuronidase-
Positive Escherichia coli

- [2] DAMARE J.M., CAMPBELL D.F. and JOHNSON R.W. Simplified direct plating method for enhanced recovery of Escherichia coli in food. *Journal of Food Science*, 50, 1985, pp. 1736-1737, 1746.
- [3] DELISLE G.L. and LEY A. Rapid detection of Escherichia coli in urine samples by a new chromogenic β -glucuronidase assay. *J. Clin. Microbiol.*, 27, 1989, pp. 778-779.
- [4] KILIAN M. and BULOW P. Rapid diagnosis of Enterobacteriaceae. Detection of bacterial glycosidases. *Acta Pathol. Microbiol. Scand., Sect. B*, 84, 1976, pp. 245-251.
- [5] KILIAN M. and BULOW P. Rapid identification of Enterobacteriaceae. Use of a β -glucuronidase detecting agar medium (PGUA agar) for the identification of Escherichia coli in primary cultures of urine samples. *Acta Pathol. Microbiol. Scand., Sect. B*, 87, 1979, pp. 271-276.
- [6] LEY A.N., BOWERS R.J. and WOLFE S. Indoxyl- β -D-glucuronide, a novel chromogenic reagent for the specific detection and enumeration of Escherichia coli in environmental sample. *Canadian Journal of Microbiology*, 34, 1988, pp. 690-693.
- [7] MANAFI M. and KNEIFEL W. A combined chromogenic-fluorogenic medium for the simultaneous detection of total coliforms and E. coli in water. *Zentralbl. Hyg.*, 189, 1989, pp. 225-234
- [8] OGDEN I.D. and WATT A.J. An evaluation of fluorogenic and chromogenic assays for the direct enumeration of Escherichia coli. *Letters in Applied Microbiology*, 13, 1991, pp. 212-215.
- [9] RESTAINO L., FRAMPTON E.W. and LYON R.H. Use of chromogenic substrate 5-bromo-4-chloro-3-indolyl- β -D-glucuronide (X-GLUC) for enumeration of Escherichia coli on 24 hours from ground beef. *J. Food Protection*, 53 (6), 1990, pp. 508-510.
- [10] WATKINS W.D., RIPPEY S.C., CLAVET C.R. KELLY-REITZ D.J. and BURKHARDT W. Novel compound for identifying Escherichia coli. *Applied Environmental Microbiology*, 54, 1988, pp. 1874-1875.

**HORIZONTAL METHOD FOR THE
ENUMERATION OF COAGULASE-
POSITIVE STAPHYLOCOCCI
(OIV-OENO 6620-2023)**

Foreword

ISO (the International Organization for Standardization) is a worldwide federation of national standards bodies (ISO member bodies). The work of preparing International Standards is normally carried out through ISO technical committees. Each member body interested in a subject for which a technical committee has been established has the right to be represented on that committee. International organizations, governmental and non-governmental, in liaison with ISO, also take part in the work. ISO collaborates closely with the International Electrotechnical Commission (IEC) on all matters of electrotechnical standardization.

The procedures used to develop this document and those intended for its further maintenance are described in the ISO/IEC Directives, Part 1. In particular, the different approval criteria needed for the different types of ISO documents should be noted. This document was drafted in accordance with the editorial rules of the ISO/IEC Directives, Part 2 (see www.iso.org/directives).

Attention is drawn to the possibility that some of the elements of this document may be the subject of patent rights. ISO shall not be held responsible for identifying any or all such patent rights. Details of any patent rights identified during the development of the document will be in the Introduction and/or on the ISO list of patent declarations received (see www.iso.org/patents).

Any trade name used in this document is information given for the convenience of users and does not constitute an endorsement.

For an explanation of the voluntary nature of standards, the meaning of ISO specific terms and expressions related to conformity assessment, as well as information about ISO's adherence to the World Trade Organization (WTO) principles in the Technical Barriers to Trade (TBT), see www.iso.org/iso/foreword.html.

This document was prepared by Technical Committee ISO/TC 34, Food products, Subcommittee SC 9, Microbiology, in collaboration with the European Committee for Standardization (CEN) Technical Committee CEN/TC 463, Microbiology of the food chain, in accordance with the Agreement on technical cooperation between ISO and CEN (Vienna Agreement).

COMPENDIUM OF INTERNATIONAL ANALYSIS OF METHODS - OIV
Horizontal method for the enumeration of Coagulase-Positive
Staphylococci

This second edition cancels and replaces the first edition (ISO 6888-2:1999), which has been technically revised. It also incorporates the Amendment ISO 6888-2:1999/Amd 1:2003. The main changes compared with the previous edition are as follows:

- the title has been changed to relate to the “food chain”;
- the status of ISO 6888-1 and this document has been clarified;
- the document has been aligned with ISO 7218:2007, i.e. and pour molten agar medium at 44 °C to 47 °C;
- all occurrences, when appropriate, have been changed from “35 °C or 37 °C” to “34 °C to 38 °C”;
- all occurrences of incubation time, when appropriate, have been changed from “18 h to 24 h” to “24 h ± 2 h”;
- requirements have been added to use ISO 11133;
- all available standards related to sampling techniques have been updated;
- flow diagram procedure in Annex A has been updated;
- culture media and reagents with performance testing have been added and moved to Annex B;
- performance testing for rabbit plasma fibrinogen agar (RPFA) medium has been added;
- results of the interlaboratory study (from ISO 6888-2:1999/Amendment 1:2003 Precision data) have been updated;
- the Bibliography has been updated.

A list of all parts in the ISO 6888 series can be found on the ISO website. Any feedback or questions on this document should be directed to the user’s national standards body. A complete listing of these bodies can be found at www.iso.org/members.html.

Introduction

ISO 6888-1, this document and ISO 6888-3 describe three horizontal methods for the detection and enumeration of coagulase-positive staphylococci among which enterotoxinogenic strains are encountered. It is mainly concerned with *Staphylococcus aureus*, but also with *S. intermedius* and certain strains of *S. hyicus*.

For the purposes of this document, the characterization of staphylococci is based on a positive coagulase reaction, but it is recognized that some strains of *Staphylococcus aureus* give weakly positive coagulase reactions. These latter strains can be confused with other bacteria but they can be distinguished by the use of additional tests not included in this document, such as tests for sensitivity to

COMPENDIUM OF INTERNATIONAL ANALYSIS OF METHODS - OIV
Horizontal method for the enumeration of Coagulase-Positive
Staphylococci

lysostaphin, and for production of haemolysin, thermostable nuclease and acid from mannitol (see ISO 7218 and Reference [13]).

The main technical changes listed in the Foreword, introduced in this document compared with the previous edition, are considered as minor (see ISO 17468). They have a minor impact on the performance characteristics of the method.

The results of the interlaboratory study and samples tested are described in Annex C.

WARNING In order to safeguard the health of laboratory personnel, it is essential that tests for enumerating staphylococci are only undertaken in properly equipped laboratories, under the control of a skilled microbiologist and that great care is taken in the disposal of all incubated materials. Persons using this document should be familiar with normal laboratory practice. This document does not purport to address all of the safety aspects, if any, associated with its use. It is the responsibility of the user to establish appropriate safety and health practices.

1. Scope

This document specifies a horizontal method for the enumeration of coagulase-positive staphylococci by counting the colonies obtained on a solid medium (rabbit plasma fibrinogen agar medium) after aerobic incubation at 34 °C to 38 °C (see Reference [10]).

This document is applicable to:

- products intended for human consumption;
- products intended for animal feeding;
- environmental samples in the area of food and feed production and handling;
- samples from the primary production stage.

This horizontal method was originally developed for the examination of all samples belonging to the food chain.

Because of the large variety of products in the food chain, it is possible that this horizontal method is not appropriate in every detail for all products. Nevertheless, it is expected that the required modifications are minimized so that they do not result in a significant deviation from this horizontal method.

Based on the information available at the time of publication of this document, this method is not considered to be (fully) suited to the examination of fermented products or other products containing technological flora based on *Staphylococcus* spp. (e.g. *S. xylosus*) (such as cheeses made from raw milk and certain raw meat products) likely to be contaminated by:

COMPENDIUM OF INTERNATIONAL ANALYSIS OF METHODS - OIV
Horizontal method for the enumeration of Coagulase-Positive
Staphylococci

- staphylococci forming atypical colonies on a Baird-Parker agar medium;
- background flora that can obscure the colonies being sought.

Nevertheless, both ISO 6888-1 and this document are given equivalent status.

2. Normative references

The following documents are referred to in the text in such a way that some or all of their content constitutes requirements of this document. For dated references, only the edition cited applies. For undated references, the latest edition of the referenced document (including any amendments) applies.

- ISO 6887 (all parts), Microbiology of the food chain — Preparation of test samples, initial suspension and decimal dilutions for microbiological examination
- ISO 7218, Microbiology of food and animal feeding stuffs — General requirements and guidance for microbiological examinations
- ISO 11133, Microbiology of food, animal feed and water — Preparation, production, storage and performance testing of culture media

3. Terms and definitions

For the purposes of this document, the following terms and definitions apply. ISO and IEC maintain terminological databases for use in standardization at the following addresses:

- ISO Online browsing platform: available at <https://www.iso.org/obp>
- IEC Electropedia: available at <http://www.electropedia.org/>

3.1. coagulase-positive staphylococci

bacteria that form typical colonies in a selective culture medium (rabbit plasma fibrinogen agar medium)

Note 1 to entry: The typical colonies are described in 9.3.

3.2. enumeration of coagulase-positive staphylococci

determination of the number of coagulase-positive staphylococci (3.1) per gram, per millilitre, per square centimetre or per sampling device/sampled area.

Note 1 to entry: A sampled area is an area not defined by a numerical size, for example, a hot tap, a door handle.

Only informative sections of standards are publicly available. To view the full content, you will need to purchase the ISO Standard.

COMPENDIUM OF INTERNATIONAL ANALYSIS OF METHODS - OIV
Horizontal method for the enumeration of Coagulase-Positive
Staphylococci

Bibliography

- [1] ISO 707, Milk and milk products — Guidance on sampling
- [2] ISO 6888-1, Microbiology of the food chain — Horizontal method for the enumeration of coagulase-positive staphylococci (*Staphylococcus aureus* and other species) — Part 1: Technique using Baird-Parker agar medium
- [3] ISO 6888-3, Microbiology of food and animal feeding stuffs — Horizontal method for the enumeration of coagulase-positive staphylococci (*Staphylococcus aureus* and other species) — Part 3: Detection and MPN technique for low numbers
- [4] ISO 13307, Microbiology of food and animal feed — Primary production stage — Sampling techniques
- [5] ISO 16140:2003, Microbiology of food and animal feeding stuffs — Protocol for the validation of alternative method
- [6] ISO 17604, Microbiology of the food chain — Carcass sampling for microbiological analysis
- [7] ISO 17468, Microbiology of the food chain — Technical requirements and guidance on establishment or revision of a standardized reference method
- [8] ISO/TS 17728, Microbiology of the food chain — Sampling techniques for microbiological analysis of food and feed samples
- [9] ISO 18593, Microbiology of the food chain — Horizontal methods for surface sampling
- [10] IDF 145A:1997, Milk and milk products — Enumeration of coagulase-positive staphylococci — Colony-count technique
- [11] BOOTHBY J., GENIGEORGIS C. and FANELLI M.J. Tandem Coagulase / Thermonuclease Agar Method for the Detection of *Staphylococcus aureus*. *Appl. and Environmental microbiology*. 1979, Vol.37, pp. 298-302.
- [12] De Buyser M.L., Lombard B., Schulten S.M., In't Veld P.H., Scotter S.L., Rollier P., Lahellec C., Validation of EN ISO standard methods 6888 part 1 and part 2:1999, Enumeration of coagulase-positive staphylococci in foods. *Int. J. Food Microbiol.* 2003, 83(2), pp. 185–194
- [13] Kloos W.E., Systematics and the natural history of staphylococci. In: *Staphylococci*, *J. Appl. Bacteriol. Symp. Suppl.*, 1990, 69, pp. 25 s–37 s; and *Bergey's Manual of Systematic Bacteriology 2nd Edition*, Vol 3, 2009, pp 372-421

Method OIV-MA-G1-07

Type IV method

**HORIZONTAL METHOD FOR THE
ENUMERATION OF MICROORGANISMS
(OIV-OENO 662P-2023)**

Foreword

ISO (the International Organization for Standardization) is a worldwide federation of national standards bodies (ISO member bodies). The work of preparing International Standards is normally carried out through ISO technical committees. Each member body interested in a subject for which a technical committee has been established has the right to be represented on that committee. International organizations, governmental and non-governmental, in liaison with ISO, also take part in the work. ISO collaborates closely with the International Electrotechnical Commission (IEC) on all matters of electrotechnical standardization.

The procedures used to develop this document and those intended for its further maintenance are described in the ISO/IEC Directives, Part 1. In particular the different approval criteria needed for the different types of ISO documents should be noted. This document was drafted in accordance with the editorial rules of the ISO/IEC Directives, Part 2, www.iso.org/directives.

Attention is drawn to the possibility that some of the elements of this document may be the subject of patent rights. ISO shall not be held responsible for identifying any or all such patent rights. Details of any patent rights identified during the development of the document will be in the Introduction and/or on the ISO list of patent declarations received, www.iso.org/patents.

Any trade name used in this document is information given for the convenience of users and does not constitute an endorsement.

The committee responsible for this document is ISO/TC 34, Food products, Subcommittee SC 9, Microbiology.

This first edition, together with ISO 4833-1, cancels and replaces ISO 4833:2003. ISO 4833 consists of the following parts, under the general title Microbiology of the food chain — Horizontal method for the enumeration of microorganisms:

- Part 1: Colony count at 30 °C by the pour plate technique
- Part 2: Colony count at 30 °C by the surface plating technique

Part 1: Colony count at 30 °C by the pour plate technique

1. Scope

This part of ISO 4833 specifies a horizontal method for enumeration of microorganisms that are able to grow and form colonies in a solid medium after aerobic incubation at 30 °C. The method is applicable to:

- a) products intended for human consumption and for animal feed;
- b) environmental samples in the area of food and feed production and handling.

This part of ISO 4833 is applicable to:

- 1) products that require a reliable count when a low limit of detection is specified (below 102/g or 102/ml for liquid samples or below 103/g for solid samples)
- 2) products expected to contain spreading colonies that obscure colonies of other organisms, e.g. milk and milk products likely to contain spreading *Bacillus* spp.

The applicability of this part of ISO 4833 to the examination of certain fermented food and animal feeds is limited and other media or incubation conditions can be more appropriate. However, this method can be applied to such products even though it is possible that the predominant microorganisms in those products are not detected effectively.

For some matrices, the method specified in this part of ISO 4833 can give different results to those obtained using the method specified in ISO 4833-2.

2. Normative references

The following documents, in whole or in part, are normatively referenced in this document and are indispensable for its application. For dated references, only the edition cited applies. For undated references, the latest edition of the referenced document (including any amendments) applies.

- ISO 6887 (all parts), Microbiology of food and animal feeding stuffs — Preparation of test samples, initial suspension and decimal dilutions for microbiological examination
- ISO 7218, Microbiology of food and animal feeding stuffs — General requirements and guidance for microbiological examinations
- ISO 11133, Microbiology of food, animal feed and water — Preparation, production, storage and performance testing of culture media

3. Terms and definitions

For the purposes of this document, the following terms and definitions apply.

3.1. microorganism

entity of microscopic size, encompassing bacteria, fungi, protozoa and viruses
[SOURCE:ISO/TS 11139:2006,3 2.26]

Note 1 to entry: For the purposes of this part of ISO 4833, microorganisms are bacteria, yeasts and moulds that are able to produce colonies under the conditions specified in this part of ISO 4833.

Note 1 to entry: For the purposes of this part of ISO 4833, microorganisms are bacteria, yeasts and moulds that are able to produce colonies under the conditions specified in this part of ISO 4833.

Only informative sections of standards are publicly available. To view the full content, you will need to purchase the ISO Standard.

Bibliography

- [1] ISO 835, Laboratory glassware — Graduated pipettes
- [2] ISO 8655-2, Piston-operated volumetric apparatus — Part 2: Piston pipettes
- [3] ISO/TS 11139:2006, Sterilization of health care products — Vocabulary
- [4] Piton C., Grappin R., A model for statistical evaluation of precision parameters of microbiological methods: Application to dry rehydratable film methods and IDG reference methods for enumeration of total aerobic mesophilic flora and coliforms in raw milk. *J. Assoc. Off. Anal. Chem.* 1991, 74 pp. 92–103
- [5] Scotter S., Aldridge M., Back J., Wood R., Validation of European Community methods for microbiological and chemical analysis of raw and heat-treated milk. *J. Assoc. Public Anal.* 1993, 29 pp. 1–32
- [6] Dahms S., Weiss H., Estimation of precision values for microbiological reference methods: Standardized pour plate technique. *Milchwissenschaft.* 1988, 53 pp. 555–559
- [7] WORLD DATA CENTRE FOR MICROORGANISMS. Reference strain catalogue pertaining to organisms for performance testing culture media. Available (viewed 2013-03-06) at: http://www.wfcc.info/pdf/WDCM_Reference_Strain_Catalogue.pdf

Part 2: Colony count at 30 °C by the surface plating technique

1. Scope

This part of ISO 4833 specifies a horizontal method for enumeration of microorganisms that are able to grow and form colonies on the surface of a solid medium after aerobic incubation at 30 °C. The method is applicable to:

- a) products intended for human consumption or for animal feed;
- b) environmental samples in the area of food and feed production and food handling.

This part of ISO 4833 is applicable to:

- 1) products containing heat-sensitive organisms that are likely to form a significant proportion of the total flora (e.g. psychrotrophic organisms in chilled and frozen foods, dried foods, other foods that may contain heat-sensitive organisms);
- 2) products containing obligately aerobic bacteria that are likely to form a significant proportion of the total flora (e.g. *Pseudomonas* spp.);
- 3) products that contain small particles that can prove difficult to distinguish from colonies in a pour plate;
- 4) products whose intense colour prevents the recognition of colonies in a pour plate;
- 5) products for which distinction between different types of colony is required as part of the assessment of food quality.

In addition to the manual spread plating technique, this part of ISO 4833 also specifies the use of a spiral plater, a rapid method of performing surface colony counts (Annex A).

The applicability of this part of ISO 4833 to the examination of certain fermented food and animal feeds is limited and other media or incubation conditions can be more appropriate. However, this method can be applied to such products even though it is possible that the predominant microorganisms in these products are not detected effectively.

For some matrices, the method described in this part of ISO 4833 can give different results to those obtained using the method described in ISO 4833-1.

2. Normative references

The following documents, in whole or in part, are normatively referenced in this document and are indispensable for its application. For dated references, only the edition cited applies. For undated references, the latest edition of the referenced document (including any amendments) applies.

- ISO 6887 (all parts), Microbiology of food and animal feeding stuffs — Preparation of test samples, initial suspension and decimal dilutions for microbiological examination
- ISO 7218, Microbiology of food and animal feeding stuffs — General requirements and guidance for microbiological examinations
- ISO 11133, Microbiology of food, animal feed and water — Preparation, production, storage and performance testing of culture media

3. Terms and definitions

For the purposes of this document, the following terms and definitions apply.

3.1. microorganism

entity of microscopic size, encompassing bacteria, fungi, protozoa and viruses
[SOURCE:ISO/TS 11139:2006,3 2.26]

Note 1 to entry: For the purposes of this part of ISO 4833, microorganisms are bacteria, yeasts and moulds that are able to produce colonies under the conditions specified in this part of ISO 4833.

Only informative sections of standards are publicly available. To view the full content, you will need to purchase the standard by clicking on the "Buy" button.

Bibliography

- [1] ISO 835, Laboratory glassware — Graduated pipettes
- [2] ISO 8655-2, Piston-operated volumetric apparatus — Part 2: Piston pipettes
- [3] ISO/TS 11139:2006, Sterilization of health care products — Vocabulary
- [4] ISO 17410, Microbiology of food and animal feeding stuffs — Horizontal method for the enumeration of psychrotrophic microorganisms
- [5] BS 4285-2.3:1984,1 Microbiological examination for dairy purposes — Methods of general application forenumeration of microorganisms —

COMPENDIUM OF INTERNATIONAL ANALYSIS OF METHODS - OIV
Horizontal method for the enumeration of microorganisms

Enumeration of microorganisms by surface plate technique for colony count

- [6] AMERICAN PUBLIC HEALTH ASSOCIATION, Standard methods for the examination of dairy products. Washington, DC: APHA, Seventeenth Edition, 2004
- [7] AOAC INTERNATIONAL, 977.27 Spiral Plate method. In: Official methods of analysis. Gaithersburg, MD: AOAC, Nineteenth Edition, 2012
- [8] Roberts D., Greenwood M., Enumeration of microorganisms. In: Practical food microbiology. Oxford: Blackwell, Third Edition, 2003, pp. 105–29.
- [9] Maturin L., Peeler J.T, Chapter 3. Aerobic plate count. In: Bacteriological analytical manual. Silver Spring, MD: US Food and Drug Administration, 2001. Available (viewed 2012-07-13) at: <http://www.fda.gov/Food/ScienceResearch/LaboratoryMethods/BacteriologicalAnalyticalManualBAM/ucm063346.htm>
- [10] Greenwood M.H., Coetzee E.F.C., Ford B.M., Gill P., Hooper W.L., Matthews S.C. et al., The microbiology of selected retail food products with an evaluation of viable counting methods. J. Hyg. (Lond.). 1984, 92 pp. 67–77
- [11] International Commission on Microbiological Specifications for Foods. Microorganisms in foods. 1 Their significance and methods of enumeration. London, ON: University of Toronto Press, Second Edition, 1978
- [12] Gilchrist J.E., Donnelly C.B., Peeler J.T., Campbell J.E., Collaborative study comparing the spiral plate and aerobic plate count methods. J. Assoc. Off. Anal. Chem. 1977, 60 pp. 807–812
- [13] Jarvis B., Lach V.H., Wood J.M., Evaluation of the spiral plate maker for the enumeration of microorganisms in foods. J. Appl. Bacteriol. 1977, 43 pp. 149–157
- [14] Kramer J.M., Gilbert R.J., Enumeration of micro-organisms in food: A comparative study of five methods. J. Hyg. (Lond.). 1978, 81 pp. 151–159
- [15] WORLD DATA CENTRE FOR MICROORGANISMS. Reference strain catalogue pertaining to organisms for performance testing culture media. Available (2013-03-07) at: http://www.wfcc.info/pdf/WDCM_Reference_Strain_Catalogue.pdf

Method OIV-MA-G1-08

Type IV method

**SOLUBLE SOLIDS IN GRAPE JUICE,
RECONSTITUTED GRAPE JUICE,
CONCENTRATED GRAPE JUICE, AND
GRAPE NECTAR
(OIV-OENO 662F-2023)**

1. Scope

This document describes the method used for determining soluble solids in grape juice, reconstituted grape juice, concentrated grape juice, and grape nectar, at the indicated concentrations ranging from 10.0 °Bx to 69.2 °Bx.

2. Principle

The soluble solids content of a sample is estimated from its refractive index at 20 °C, expressed either as an absolute value or as a percentage by mass of saccharose (degrees Brix), the value is set out on the Table II to obtain the sugar content in grams per litre and in grams per kilogram for grape juice, reconstituted grape juice, concentrated grape juice or grape nectar.

3. Apparatus

3. 1. Abbe refractometer

The refractometer used must be fitted with a scale giving:

- either percentage by mass of saccharose to 0.1 %;
- or refractive indices to four decimal places.

The refractometer must be equipped with a thermometer having a scale extending at least from + 15 °C to + 25 °C and with a system for circulating water that will enable measurements to be made at a temperature of 20 ± 5 °C. The operating instructions for this instrument must be strictly adhered to, particularly with regard to calibration and the light source.

Note: An electronic refractometer can also be used. In this case, a correction is not necessary for devices that automatically take temperature into account.

3.2. Analytical balance verified and calibrated with minimum precision of 0.01 g.

4. Preparation of the sample

Pass the sample through a filter paper or dry gauze folded into four and, after discarding the first drops of the filtrate, carry out the determination on the filtered product.

In the case of concentrated grape juice, depending on its concentration, use the sample directly or prepare a dilution weighing 200 g of concentrated grape juice and adding purified water for laboratories (EN ISO 3696) up to 500 g ($F = 2.5$).

5. Procedure

Bring the sample to a temperature close to 20 °C. Place a small test sample on the lower prism of the refractometer, taking care (because the prisms are pressed firmly against each other) that this test sample covers the glass surface uniformly. Carry out the measurement in accordance with the operating instructions of the instrument manufacturer used. Read the percentage by mass of sucrose to within one decimal place or read the refractive index to four decimal places. Carry out at least two determinations on the same prepared sample. Note the temperature in t °C.

6. Calculation

6.1. Temperature correction

- Instruments graduated in percentage by mass of sucrose: use Table I to obtain the temperature correction.

Table I - Correction to be made in the case where the percentage by mass of saccharose was determined at a temperature different by 20°C.

COMPENDIUM OF INTERNATIONAL ANALYSIS OF METHODS - OIV
Soluble solids in grape juice, reconstituted grape juice,
concentrated grape juice, and grape nectar

Temperature (°C)	Percentage by mass measured													
	10	15	20	25	30	35	40	45	50	55	60	65	70	75
5	-0.82	-0.87	-0.92	-0.95	-0.99									
6	-0.80	-0.82	-0.87	-0.90	-0.94									
7	-0.74	-0.78	-0.82	-0.84	-0.88									
8	-0.69	-0.73	-0.76	-0.79	-0.82									
9	-0.64	-0.67	-0.71	-0.73	-0.75									
10	-0.59	-0.62	-0.65	-0.67	-0.69	-0.71	-0.72	-0.73	-0.74	-0.75	-0.75	-0.75	-0.75	-0.75
11	-0.54	-0.57	-0.59	-0.61	-0.63	-0.64	-0.65	-0.66	-0.67	-0.68	-0.68	-0.68	-0.68	-0.67
12	-0.49	-0.51	-0.53	-0.55	-0.56	-0.57	-0.58	-0.59	-0.60	-0.60	-0.61	-0.61	-0.60	-0.60
13	-0.43	-0.45	-0.47	-0.48	-0.50	-0.51	-0.52	-0.52	-0.53	-0.53	-0.53	-0.53	-0.53	-0.53
14	-0.38	-0.39	-0.40	-0.42	-0.43	-0.44	-0.44	-0.45	-0.45	-0.46	-0.46	-0.46	-0.46	-0.45
15	-0.32	-0.33	-0.34	-0.35	-0.36	-0.37	-0.37	-0.38	-0.38	-0.38	-0.38	-0.38	-0.38	-0.38
16	-0.26	-0.27	-0.28	-0.28	-0.29	-0.30	-0.30	-0.30	-0.31	-0.31	-0.31	-0.31	-0.31	-0.30
17	-0.20	-0.20	-0.21	-0.21	-0.22	-0.22	-0.23	-0.23	-0.23	-0.23	-0.23	-0.23	-0.23	-0.23
18	-0.13	-0.14	-0.14	-0.14	-0.15	-0.15	-0.15	-0.15	-0.15	-0.15	-0.15	-0.15	-0.15	-0.15
19	-0.07	-0.07	-0.07	-0.07	-0.07	-0.08	-0.08	-0.08	-0.08	-0.08	-0.08	-0.08	-0.08	-0.08
	REFERENCE													
21	+0.07	+0.07	+0.07	+0.07	+0.08	+0.08	+0.08	+0.08	+0.08	+0.08	+0.08	+0.08	+0.08	+0.08
22	+0.14	+0.14	+0.15	+0.15	+0.15	+0.15	+0.16	+0.16	+0.16	+0.16	+0.16	+0.16	+0.15	+0.15
23	+0.21	+0.22	+0.22	+0.23	+0.23	+0.23	+0.23	+0.24	+0.24	+0.24	+0.24	+0.23	+0.23	+0.23
24	+0.29	+0.29	+0.30	+0.30	+0.31	+0.31	+0.31	+0.32	+0.32	+0.32	+0.32	+0.31	+0.31	+0.31
25	+0.36	+0.37	+0.38	+0.38	+0.39	+0.39	+0.40	+0.40	+0.40	+0.40	+0.40	+0.39	+0.39	+0.39
26	+0.44	+0.45	+0.46	+0.46	+0.47	+0.47	+0.48	+0.48	+0.48	+0.48	+0.48	+0.47	+0.47	+0.46
27	+0.52	+0.53	+0.54	+0.55	+0.55	+0.56	+0.56	+0.56	+0.56	+0.56	+0.56	+0.55	+0.55	+0.54
28	+0.60	+0.61	+0.62	+0.63	+0.64	+0.64	+0.64	+0.65	+0.65	+0.65	+0.64	+0.64	+0.63	+0.62
29	+0.68	+0.69	+0.70	+0.71	+0.72	+0.73	+0.73	+0.73	+0.73	+0.73	+0.72	+0.72	+0.71	+0.70
30	+0.77	+0.78	+0.79	+0.80	+0.81	+0.81	+0.81	+0.82	+0.81	+0.81	+0.81	+0.80	+0.79	+0.78
31	+0.85	+0.87	+0.88	+0.89	+0.89	+0.90	+0.90	+0.90	+0.90	+0.90	+0.89	+0.88	+0.87	+0.86
32	+0.94	+0.95	+0.96	+0.97	+0.98	+0.99	+0.99	+0.99	+0.99	+0.99	+0.98	+0.96	+0.95	+0.94
33	+1.03	+1.04	+1.05	+1.06	+1.07	+1.08	+1.08	+1.08	+1.07	+1.07	+1.06	+1.05	+1.03	+1.02
34	+1.12	+1.19	+1.15	+1.15	+1.16	+1.17	+1.17	+1.17	+1.16	+1.15	+1.14	+1.13	+1.12	+1.10
35	+1.22	+1.23	+1.24	+1.25	+1.25	+1.26	+1.26	+1.25	+1.25	+1.24	+1.23	+1.21	+1.20	+1.18
36	+1.31	+1.32	+1.33	+1.34	+1.35	+1.35	+1.35	+1.35	+1.34	+1.33	+1.32	+1.30	+1.28	+1.26
37	+1.41	+1.42	+1.43	+1.44	+1.44	+1.44	+1.44	+1.44	+1.43	+1.42	+1.40	+1.38	+1.36	+1.34
38	+1.51	+1.52	+1.53	+1.53	+1.54	+1.54	+1.53	+1.53	+1.52	+1.51	+1.49	+1.47	+1.45	+1.42
39	+1.61	+1.62	+1.62	+1.63	+1.63	+1.63	+1.63	+1.62	+1.61	+1.60	+1.58	+1.56	+1.53	+1.50
40	+1.71	+1.72	+1.72	+1.73	+1.73	+1.73	+1.72	+1.71	+1.70	+1.69	+1.67	+1.64	+1.62	+1.59

It is preferable that the variations in temperature in relation to 20 °C do not exceed
 5 °C.

- Instruments graduated in refractive index: find the refractive index measured (2nd column) in Table II to obtain the corresponding value of the percentage by mass of sucrose (1st column). This value is corrected for temperature and expressed as a concentration at 20°C by means of Table I.

TABLE II - Table giving the sugar content of musts and concentrated musts in grammes per litre and in grammes per kilogramme, determined using a graduated refractometer, either in percentage by

COMPENDIUM OF INTERNATIONAL ANALYSIS OF METHODS - OIV
Soluble solids in grape juice, reconstituted grape juice,
concentrated grape juice, and grape nectar

mass of saccharose at 20 °C or refractive index at 20 °C. The mass density at 20 °C is also given.

Saccharose (%(m/m))	Refractive Index at 20 °C	Mass Density at 20 °C	Sugars (g/L)	Sugars (g/kg)	ABV (% v/v) at 20 °C
10.0	1.34782	1.0391	82.2	79.1	4.89
10.1	1.34798	1.0395	83.3	80.1	4.95
10.2	1.34813	1.0399	84.3	81.1	5.01
10.3	1.34829	1.0403	85.4	82.1	5.08
10.4	1.34844	1.0407	86.5	83.1	5.14
10.5	1.34860	1.0411	87.5	84.1	5.20
10.6	1.34875	1.0415	88.6	85.0	5.27
10.7	1.34891	1.0419	89.6	86.0	5.32
10.8	1.34906	1.0423	90.7	87.0	5.39
10.9	1.34922	1.0427	91.8	88.0	5.46
11.0	1.34937	1.0431	92.8	89.0	5.52
11.1	1.34953	1.0436	93.9	90.0	5.58
11.2	1.34968	1.0440	95.0	91.0	5.65
11.3	1.34984	1.0444	96.0	92.0	5.71
11.4	1.34999	1.0448	97.1	92.9	5.77
11.5	1.35015	1.0452	98.2	93.9	5.84
11.6	1.35031	1.0456	99.3	94.9	5.90
11.7	1.35046	1.0460	100.3	95.9	5.96
11.8	1.35062	1.0464	101.4	96.9	6.03
11.9	1.35077	1.0468	102.5	97.9	6.09
12.0	1.35093	1.0472	103.5	98.9	6.15
12.1	1.35109	1.0477	104.6	99.9	6.22
12.2	1.35124	1.0481	105.7	100.8	6.28
12.3	1.35140	1.0485	106.8	101.8	6.35
12.4	1.35156	1.0489	107.8	102.8	6.41
12.5	1.35171	1.0493	108.9	103.8	6.47
12.6	1.35187	1.0497	110.0	104.8	6.54
12.7	1.35203	1.0501	111.1	105.8	6.60
12.8	1.35219	1.0506	112.2	106.8	6.67
12.9	1.35234	1.0510	113.2	107.8	6.73
13.0	1.35250	1.0514	114.3	108.7	6.79
13.1	1.35266	1.0518	115.4	109.7	6.86
13.2	1.35282	1.0522	116.5	110.7	6.92
13.3	1.35298	1.0527	117.6	111.7	6.99
13.4	1.35313	1.0531	118.7	112.7	7.05
13.5	1.35329	1.0535	119.7	113.7	7.11
13.6	1.35345	1.0539	120.8	114.7	7.18
13.7	1.35361	1.0543	121.9	115.6	7.24
13.8	1.35377	1.0548	123.0	116.6	7.31
13.9	1.35393	1.0552	124.1	117.6	7.38
14.0	1.35408	1.0556	125.2	118.6	7.44

COMPENDIUM OF INTERNATIONAL ANALYSIS OF METHODS - OIV
Soluble solids in grape juice, reconstituted grape juice,
concentrated grape juice, and grape nectar

Saccharose (%/m/m)	Refractive Index at 20 °C	Mass Density at 20 °C	Sugars (g/L)	Sugars (g/kg)	ABV (% v/v) at 20 °C
14.1	1.35424	1.0560	126.3	119.6	7.51
14.2	1.35440	1.0564	127.4	120.6	7.57
14.3	1.35456	1.0569	128.5	121.6	7.64
14.4	1.35472	1.0573	129.6	122.5	7.70
14.5	1.35488	1.0577	130.6	123.5	7.76
14.6	1.35504	1.0581	131.7	124.5	7.83
14.7	1.35520	1.0586	132.8	125.5	7.89
14.8	1.35536	1.0590	133.9	126.5	7.96
14.9	1.35552	1.0594	135.0	127.5	8.02
15.0	1.35568	1.0598	136.1	128.4	8.09
15.1	1.35584	1.0603	137.2	129.4	8.15
15.2	1.35600	1.0607	138.3	130.4	8.22
15.3	1.35616	1.0611	139.4	131.4	8.28
15.4	1.35632	1.0616	140.5	132.4	8.35
15.5	1.35648	1.0620	141.6	133.4	8.42
15.6	1.35664	1.0624	142.7	134.3	8.48
15.7	1.35680	1.0628	143.8	135.3	8.55
15.8	1.35696	1.0633	144.9	136.3	8.61
15.9	1.35713	1.0637	146.0	137.3	8.68
16.0	1.35729	1.0641	147.1	138.3	8.74
16.1	1.35745	1.0646	148.2	139.3	8.81
16.2	1.35761	1.0650	149.3	140.2	8.87
16.3	1.35777	1.0654	150.5	141.2	8.94
16.4	1.35793	1.0659	151.6	142.2	9.01
16.5	1.35810	1.0663	152.7	143.2	9.07
16.6	1.35826	1.0667	153.8	144.2	9.14
16.7	1.35842	1.0672	154.9	145.1	9.21
16.8	1.35858	1.0676	156.0	146.1	9.27
16.9	1.35874	1.0680	157.1	147.1	9.34
17.0	1.35891	1.0685	158.2	148.1	9.40
17.1	1.35907	1.0689	159.3	149.1	9.47
17.2	1.35923	1.0693	160.4	150.0	9.53
17.3	1.35940	1.0698	161.6	151.0	9.60
17.4	1.35956	1.0702	162.7	152.0	9.67
17.5	1.35972	1.0707	163.8	153.0	9.73
17.6	1.35989	1.0711	164.9	154.0	9.80
17.7	1.36005	1.0715	166.0	154.9	9.87
17.8	1.36021	1.0720	167.1	155.9	9.93
17.9	1.36038	1.0724	168.3	156.9	10.00
18.0	1.36054	1.0729	169.4	157.9	10.07
18.1	1.36070	1.0733	170.5	158.9	10.13
18.2	1.36087	1.0737	171.6	159.8	10.20
18.3	1.36103	1.0742	172.7	160.8	10.26

COMPENDIUM OF INTERNATIONAL ANALYSIS OF METHODS - OIV
Soluble solids in grape juice, reconstituted grape juice,
concentrated grape juice, and grape nectar

Saccharose (%/m/m)	Refractive Index at 20 °C	Mass Density at 20 °C	Sugars (g/L)	Sugars (g/kg)	ABV (% v/v) at 20 °C
18.4	1.36120	1.0746	173.9	161.8	10.33
18.5	1.36136	1.0751	175.0	162.8	10.40
18.6	1.36153	1.0755	176.1	163.7	10.47
18.7	1.36169	1.0760	177.2	164.7	10.53
18.8	1.36185	1.0764	178.4	165.7	10.60
18.9	1.36202	1.0768	179.5	166.7	10.67
19.0	1.36219	1.0773	180.6	167.6	10.73
19.1	1.36235	1.0777	181.7	168.6	10.80
19.2	1.36252	1.0782	182.9	169.6	10.87
19.3	1.36268	1.0786	184.0	170.6	10.94
19.4	1.36285	1.0791	185.1	171.5	11.00
19.5	1.36301	1.0795	186.2	172.5	11.07
19.6	1.36318	1.0800	187.4	173.5	11.14
19.7	1.36334	1.0804	188.5	174.5	11.20
19.8	1.36351	1.0809	189.6	175.4	11.27
19.9	1.36368	1.0813	190.8	176.4	11.34
20.0	1.36384	1.0818	191.9	177.4	11.40
20.1	1.36401	1.0822	193.0	178.4	11.47
20.2	1.36418	1.0827	194.2	179.3	11.54
20.3	1.36434	1.0831	195.3	180.3	11.61
20.4	1.36451	1.0836	196.4	181.3	11.67
20.5	1.36468	1.0840	197.6	182.3	11.74
20.6	1.36484	1.0845	198.7	183.2	11.81
20.7	1.36501	1.0849	199.8	184.2	11.87
20.8	1.36518	1.0854	201.0	185.2	11.95
20.9	1.36535	1.0858	202.1	186.1	12.01
21.0	1.36551	1.0863	203.3	187.1	12.08
21.1	1.36568	1.0867	204.4	188.1	12.15
21.2	1.36585	1.0872	205.5	189.1	12.21
21.3	1.36602	1.0876	206.7	190.0	12.28
21.4	1.36619	1.0881	207.8	191.0	12.35
21.5	1.36635	1.0885	209.0	192.0	12.42
21.6	1.36652	1.0890	210.1	192.9	12.49
21.7	1.36669	1.0895	211.3	193.9	12.56
21.8	1.36686	1.0899	212.4	194.9	12.62
21.9	1.36703	1.0904	213.6	195.9	12.69
22.0	1.36720	1.0908	214.7	196.8	12.76
22.1	1.36737	1.0913	215.9	197.8	12.83
22.2	1.36754	1.0917	217.0	198.8	12.90
22.3	1.36771	1.0922	218.2	199.7	12.97
22.4	1.36787	1.0927	219.3	200.7	13.03
22.5	1.36804	1.0931	220.5	201.7	13.10
22.6	1.36821	1.0936	221.6	202.6	13.17

COMPENDIUM OF INTERNATIONAL ANALYSIS OF METHODS - OIV
Soluble solids in grape juice, reconstituted grape juice,
concentrated grape juice, and grape nectar

Saccharose (%(m/m))	Refractive Index at 20 °C	Mass Density at 20 °C	Sugars (g/L)	Sugars (g/kg)	ABV (% v/v) at 20 °C
22.7	1.36838	1.0940	222.8	203.6	13.24
22.8	1.36855	1.0945	223.9	204.6	13.31
22.9	1.36872	1.0950	225.1	205.5	13.38
23.0	1.36889	1.0954	226.2	206.5	13.44
23.1	1.36906	1.0959	227.4	207.5	13.51
23.2	1.36924	1.0964	228.5	208.4	13.58
23.3	1.36941	1.0968	229.7	209.4	13.65
23.4	1.36958	1.0973	230.8	210.4	13.72
23.5	1.36975	1.0977	232.0	211.3	13.79
23.6	1.36992	1.0982	233.2	212.3	13.86
23.7	1.37009	1.0987	234.3	213.3	13.92
23.8	1.37026	1.0991	235.5	214.2	14.00
23.9	1.37043	1.0996	236.6	215.2	14.06
24.0	1.37060	1.1001	237.8	216.2	14.13
24.1	1.37078	1.1005	239.0	217.1	14.20
24.2	1.37095	1.1010	240.1	218.1	14.27
24.3	1.37112	1.1015	241.3	219.1	14.34
24.4	1.37129	1.1019	242.5	220.0	14.41
24.5	1.37146	1.1024	243.6	221.0	14.48
24.6	1.37164	1.1029	244.8	222.0	14.55
24.7	1.37181	1.1033	246.0	222.9	14.62
24.8	1.37198	1.1038	247.1	223.9	14.69
24.9	1.37216	1.1043	248.3	224.8	14.76
25.0	1.37233	1.1047	249.5	225.8	14.83
25.1	1.37250	1.1052	250.6	226.8	14.89
25.2	1.37267	1.1057	251.8	227.7	14.96
25.3	1.37285	1.1062	253.0	228.7	15.04
25.4	1.37302	1.1066	254.1	229.7	15.10
25.5	1.37319	1.1071	255.3	230.6	15.17
25.6	1.37337	1.1076	256.5	231.6	15.24
25.7	1.37354	1.1080	257.7	232.5	15.32
25.8	1.37372	1.1085	258.8	233.5	15.38
25.9	1.37389	1.1090	260.0	234.5	15.45
26.0	1.37407	1.1095	261.2	235.4	15.52
26.1	1.37424	1.1099	262.4	236.4	15.59
26.2	1.37441	1.1104	263.6	237.3	15.67
26.3	1.37459	1.1109	264.7	238.3	15.73
26.4	1.37476	1.1114	265.9	239.3	15.80
26.5	1.37494	1.1118	267.1	240.2	15.87
26.6	1.37511	1.1123	268.3	241.2	15.95
26.7	1.37529	1.1128	269.5	242.1	16.02
26.8	1.37546	1.1133	270.6	243.1	16.08
26.9	1.37564	1.1138	271.8	244.1	16.15

COMPENDIUM OF INTERNATIONAL ANALYSIS OF METHODS - OIV
Soluble solids in grape juice, reconstituted grape juice,
concentrated grape juice, and grape nectar

Saccharose (%(m/m))	Refractive Index at 20 °C	Mass Density at 20 °C	Sugars (g/L)	Sugars (g/kg)	ABV (% v/v) at 20 °C
27.0	1.37582	1.1142	273.0	245.0	16.22
27.1	1.37599	1.1147	274.2	246.0	16.30
27.2	1.37617	1.1152	275.4	246.9	16.37
27.3	1.37634	1.1157	276.6	247.9	16.44
27.4	1.37652	1.1161	277.8	248.9	16.51
27.5	1.37670	1.1166	278.9	249.8	16.58
27.6	1.37687	1.1171	280.1	250.8	16.65
27.7	1.37705	1.1176	281.3	251.7	16.72
27.8	1.37723	1.1181	282.5	252.7	16.79
27.9	1.37740	1.1185	283.7	253.6	16.86
28.0	1.37758	1.1190	284.9	254.6	16.93
28.1	1.37776	1.1195	286.1	255.5	17.00
28.2	1.37793	1.1200	287.3	256.5	17.07
28.3	1.37811	1.1205	288.5	257.5	17.15
28.4	1.37829	1.1210	289.7	258.4	17.22
28.5	1.37847	1.1214	290.9	259.4	17.29
28.6	1.37864	1.1219	292.1	260.3	17.36
28.7	1.37882	1.1224	293.3	261.3	17.43
28.8	1.37900	1.1229	294.5	262.2	17.50
28.9	1.37918	1.1234	295.7	263.2	17.57
29.0	1.37936	1.1239	296.9	264.2	17.64
29.1	1.37954	1.1244	298.1	265.1	17.72
29.2	1.37972	1.1248	299.3	266.1	17.79
29.3	1.37989	1.1253	300.5	267.0	17.86
29.4	1.38007	1.1258	301.7	268.0	17.93
29.5	1.38025	1.1263	302.9	268.9	18.00
29.6	1.38043	1.1268	304.1	269.9	18.07
29.7	1.38061	1.1273	305.3	270.8	18.14
29.8	1.38079	1.1278	306.5	271.8	18.22
29.9	1.38097	1.1283	307.7	272.7	18.29
30.0	1.38115	1.1287	308.9	273.7	18.36
30.1	1.38133	1.1292	310.1	274.6	18.43
30.2	1.38151	1.1297	311.3	275.6	18.50
30.3	1.38169	1.1302	312.6	276.5	18.58
30.4	1.38187	1.1307	313.8	277.5	18.65
30.5	1.38205	1.1312	315.0	278.5	18.72
30.6	1.38223	1.1317	316.2	279.4	18.79
30.7	1.38241	1.1322	317.4	280.4	18.86
30.8	1.38259	1.1327	318.6	281.3	18.93
30.9	1.38277	1.1332	319.8	282.3	19.01
31.0	1.38296	1.1337	321.1	283.2	19.08
31.1	1.38314	1.1342	322.3	284.2	19.15
31.2	1.38332	1.1346	323.5	285.1	19.23

COMPENDIUM OF INTERNATIONAL ANALYSIS OF METHODS - OIV
Soluble solids in grape juice, reconstituted grape juice,
concentrated grape juice, and grape nectar

Saccharose (%(m/m))	Refractive Index at 20 °C	Mass Density at 20 °C	Sugars (g/L)	Sugars (g/kg)	ABV (% v/v) at 20 °C
31.3	1.38350	1.1351	324.7	286.1	19.30
31.4	1.38368	1.1356	325.9	287.0	19.37
31.5	1.38386	1.1361	327.2	288.0	19.45
31.6	1.38405	1.1366	328.4	288.9	19.52
31.7	1.38423	1.1371	329.6	289.9	19.59
31.8	1.38441	1.1376	330.8	290.8	19.66
31.9	1.38459	1.1381	332.1	291.8	19.74
32.0	1.38478	1.1386	333.3	292.7	19.81
32.1	1.38496	1.1391	334.5	293.7	19.88
32.2	1.38514	1.1396	335.7	294.6	19.95
32.3	1.38532	1.1401	337.0	295.6	20.03
32.4	1.38551	1.1406	338.2	296.5	20.10
32.5	1.38569	1.1411	339.4	297.5	20.17
32.6	1.38587	1.1416	340.7	298.4	20.25
32.7	1.38606	1.1421	341.9	299.4	20.32
32.8	1.38624	1.1426	343.1	300.3	20.39
32.9	1.38643	1.1431	344.4	301.3	20.47
33.0	1.38661	1.1436	345.6	302.2	20.54
33.1	1.38679	1.1441	346.8	303.2	20.61
33.2	1.38698	1.1446	348.1	304.1	20.69
33.3	1.38716	1.1451	349.3	305.0	20.76
33.4	1.38735	1.1456	350.6	306.0	20.84
33.5	1.38753	1.1461	351.8	306.9	20.91
33.6	1.38772	1.1466	353.0	307.9	20.98
33.7	1.38790	1.1471	354.3	308.8	21.06
33.8	1.38809	1.1476	355.5	309.8	21.13
33.9	1.38827	1.1481	356.8	310.7	21.20
34.0	1.38846	1.1486	358.0	311.7	21.28
34.1	1.38864	1.1491	359.2	312.6	21.35
34.2	1.38883	1.1496	360.5	313.6	21.42
34.3	1.38902	1.1501	361.7	314.5	21.50
34.4	1.38920	1.1507	363.0	315.5	21.57
34.5	1.38939	1.1512	364.2	316.4	21.64
34.6	1.38958	1.1517	365.5	317.4	21.72
34.7	1.38976	1.1522	366.7	318.3	21.79
34.8	1.38995	1.1527	368.0	319.2	21.87
34.9	1.39014	1.1532	369.2	320.2	21.94
35.0	1.39032	1.1537	370.5	321.1	22.02
35.1	1.39051	1.1542	371.8	322.1	22.10
35.2	1.39070	1.1547	373.0	323.0	22.17
35.3	1.39088	1.1552	374.3	324.0	22.24
35.4	1.39107	1.1557	375.5	324.9	22.32

COMPENDIUM OF INTERNATIONAL ANALYSIS OF METHODS - OIV
Soluble solids in grape juice, reconstituted grape juice,
concentrated grape juice, and grape nectar

Saccharose (%/m/m)	Refractive Index at 20 °C	Mass Density at 20 °C	Sugars (g/L)	Sugars (g/kg)	ABV (% v/v) at 20 °C
35.5	1.39126	1.1563	376.8	325.9	22.39
35.6	1.39145	1.1568	378.0	326.8	22.46
35.7	1.39164	1.1573	379.3	327.8	22.54
35.8	1.39182	1.1578	380.6	328.7	22.62
35.9	1.39201	1.1583	381.8	329.6	22.69
36.0	1.39220	1.1588	383.1	330.6	22.77
36.1	1.39239	1.1593	384.4	331.5	22.84
36.2	1.39258	1.1598	385.6	332.5	22.92
36.3	1.39277	1.1603	386.9	333.4	22.99
36.4	1.39296	1.1609	388.1	334.4	23.06
36.5	1.39314	1.1614	389.4	335.3	23.14
36.6	1.39333	1.1619	390.7	336.3	23.22
36.7	1.39352	1.1624	392.0	337.2	23.30
36.8	1.39371	1.1629	393.2	338.1	23.37
36.9	1.39390	1.1634	394.5	339.1	23.45
37.0	1.39409	1.1640	395.8	340.0	23.52
37.1	1.39428	1.1645	397.0	341.0	23.59
37.2	1.39447	1.1650	398.3	341.9	23.67
37.3	1.39466	1.1655	399.6	342.9	23.75
37.4	1.39485	1.1660	400.9	343.8	23.83
37.5	1.39504	1.1665	402.1	344.7	23.90
37.6	1.39524	1.1671	403.4	345.7	23.97
37.7	1.39543	1.1676	404.7	346.6	24.05
37.8	1.39562	1.1681	406.0	347.6	24.13
37.9	1.39581	1.1686	407.3	348.5	24.21
38.0	1.39600	1.1691	408.6	349.4	24.28
38.1	1.39619	1.1697	409.8	350.4	24.35
38.2	1.39638	1.1702	411.1	351.3	24.43
38.3	1.39658	1.1707	412.4	352.3	24.51
38.4	1.39677	1.1712	413.7	353.2	24.59
38.5	1.39696	1.1717	415.0	354.2	24.66
38.6	1.39715	1.1723	416.3	355.1	24.74
38.7	1.39734	1.1728	417.6	356.0	24.82
38.8	1.39754	1.1733	418.8	357.0	24.89
38.9	1.39773	1.1738	420.1	357.9	24.97
39.0	1.39792	1.1744	421.4	358.9	25.04
39.1	1.39812	1.1749	422.7	359.8	25.12
39.2	1.39831	1.1754	424.0	360.7	25.20
39.3	1.39850	1.1759	425.3	361.7	25.28

COMPENDIUM OF INTERNATIONAL ANALYSIS OF METHODS - OIV
Soluble solids in grape juice, reconstituted grape juice,
concentrated grape juice, and grape nectar

Saccharose (%(m/m))	Refractive Index at 20 °C	Mass Density at 20 °C	Sugars (g/L)	Sugars (g/kg)	ABV (% v/v) at 20 °C
39.4	1.39870	1.1765	426.6	362.6	25.35
39.5	1.39889	1.1770	427.9	363.6	25.43
39.6	1.39908	1.1775	429.2	364.5	25.51
39.7	1.39928	1.1780	430.5	365.4	25.58
39.8	1.39947	1.1786	431.8	366.4	25.66
39.9	1.39967	1.1791	433.1	367.3	25.74
40.0	1.39986	1.1796	434.4	368.3	25.82
40.1	1.40006	1.1801	435.7	369.2	25.89
40.2	1.40025	1.1807	437.0	370.1	25.97
40.3	1.40044	1.1812	438.3	371.1	26.05
40.4	1.40064	1.1817	439.6	372.0	26.13
40.5	1.40083	1.1823	440.9	373.0	26.20
40.6	1.40103	1.1828	442.2	373.9	26.28
40.7	1.40123	1.1833	443.6	374.8	26.36
40.8	1.40142	1.1839	444.9	375.8	26.44
40.9	1.40162	1.1844	446.2	376.7	26.52
41.0	1.40181	1.1849	447.5	377.7	26.59
41.1	1.40201	1.1855	448.8	378.6	26.67
41.2	1.40221	1.1860	450.1	379.5	26.75
41.3	1.40240	1.1865	451.4	380.5	26.83
41.4	1.40260	1.1871	452.8	381.4	26.91
41.5	1.40280	1.1876	454.1	382.3	26.99
41.6	1.40299	1.1881	455.4	383.3	27.06
41.7	1.40319	1.1887	456.7	384.2	27.14
41.8	1.40339	1.1892	458.0	385.2	27.22
41.9	1.40358	1.1897	459.4	386.1	27.30
42.0	1.40378	1.1903	460.7	387.0	27.38
42.1	1.40398	1.1908	462.0	388.0	27.46
42.2	1.40418	1.1913	463.3	388.9	27.53
42.3	1.40437	1.1919	464.7	389.9	27.62
42.4	1.40457	1.1924	466.0	390.8	27.69
42.5	1.40477	1.1929	467.3	391.7	27.77
42.6	1.40497	1.1935	468.6	392.7	27.85
42.7	1.40517	1.1940	470.0	393.6	27.93
42.8	1.40537	1.1946	471.3	394.5	28.01
42.9	1.40557	1.1951	472.6	395.5	28.09
43.0	1.40576	1.1956	474.0	396.4	28.17
43.1	1.40596	1.1962	475.3	397.3	28.25
43.2	1.40616	1.1967	476.6	398.3	28.32

COMPENDIUM OF INTERNATIONAL ANALYSIS OF METHODS - OIV
Soluble solids in grape juice, reconstituted grape juice,
concentrated grape juice, and grape nectar

Saccharose (%(m/m))	Refractive Index at 20 °C	Mass Density at 20 °C	Sugars (g/L)	Sugars (g/kg)	ABV (% v/v) at 20 °C
43.3	1.40636	1.1973	478.0	399.2	28.41
43.4	1.40656	1.1978	479.3	400.2	28.48
43.5	1.40676	1.1983	480.7	401.1	28.57
43.6	1.40696	1.1989	482.0	402.0	28.65
43.7	1.40716	1.1994	483.3	403.0	28.72
43.8	1.40736	1.2000	484.7	403.9	28.81
43.9	1.40756	1.2005	486.0	404.8	28.88
44.0	1.40776	1.2011	487.4	405.8	28.97
44.1	1.40796	1.2016	488.7	406.7	29.04
44.2	1.40817	1.2022	490.1	407.6	29.13
44.3	1.40837	1.2027	491.4	408.6	29.20
44.4	1.40857	1.2032	492.8	409.5	29.29
44.5	1.40877	1.2038	494.1	410.4	29.36
44.6	1.40897	1.2043	495.5	411.4	29.45
44.7	1.40917	1.2049	496.8	412.3	29.52
44.8	1.40937	1.2054	498.2	413.3	29.61
44.9	1.40958	1.2060	499.5	414.2	29.69
45.0	1.40978	1.2065	500.9	415.1	29.77
45.1	1.40998	1.2071	502.2	416.1	29.85
45.2	1.41018	1.2076	503.6	417.0	29.93
45.3	1.41039	1.2082	504.9	417.9	30.01
45.4	1.41059	1.2087	506.3	418.9	30.09
45.5	1.41079	1.2093	507.7	419.8	30.17
45.6	1.41099	1.2098	509.0	420.7	30.25
45.7	1.41120	1.2104	510.4	421.7	30.33
45.8	1.41140	1.2109	511.7	422.6	30.41
45.9	1.41160	1.2115	513.1	423.5	30.49
46.0	1.41181	1.2120	514.5	424.5	30.58
46.1	1.41201	1.2126	515.8	425.4	30.65
46.2	1.41222	1.2131	517.2	426.3	30.74
46.3	1.41242	1.2137	518.6	427.3	30.82
46.4	1.41262	1.2142	519.9	428.2	30.90
46.5	1.41283	1.2148	521.3	429.1	30.98
46.6	1.41303	1.2154	522.7	430.1	31.06
46.7	1.41324	1.2159	524.1	431.0	31.15
46.8	1.41344	1.2165	525.4	431.9	31.22
46.9	1.41365	1.2170	526.8	432.9	31.31
47.0	1.41385	1.2176	528.2	433.8	31.39
47.1	1.41406	1.2181	529.6	434.7	31.47

COMPENDIUM OF INTERNATIONAL ANALYSIS OF METHODS - OIV
Soluble solids in grape juice, reconstituted grape juice,
concentrated grape juice, and grape nectar

Saccharose (%(m/m))	Refractive Index at 20 °C	Mass Density at 20 °C	Sugars (g/L)	Sugars (g/kg)	ABV (% v/v) at 20 °C
47.2	1.41427	1.2187	530.9	435.7	31.55
47.3	1.41447	1.2192	532.3	436.6	31.63
47.4	1.41468	1.2198	533.7	437.5	31.72
47.5	1.41488	1.2204	535.1	438.5	31.80
47.6	1.41509	1.2209	536.5	439.4	31.88
47.7	1.41530	1.2215	537.9	440.3	31.97
47.8	1.41550	1.2220	539.2	441.3	32.04
47.9	1.41571	1.2226	540.6	442.2	32.13
48.0	1.41592	1.2232	542.0	443.1	32.21
48.1	1.41612	1.2237	543.4	444.1	32.29
48.2	1.41633	1.2243	544.8	445.0	32.38
48.3	1.41654	1.2248	546.2	445.9	32.46
48.4	1.41674	1.2254	547.6	446.8	32.54
48.5	1.41695	1.2260	549.0	447.8	32.63
48.6	1.41716	1.2265	550.4	448.7	32.71
48.7	1.41737	1.2271	551.8	449.6	32.79
48.8	1.41758	1.2277	553.2	450.6	32.88
48.9	1.41779	1.2282	554.6	451.5	32.96
49.0	1.41799	1.2288	556.0	452.4	33.04
49.1	1.41820	1.2294	557.4	453.4	33.13
49.2	1.41841	1.2299	558.8	454.3	33.21
49.3	1.41862	1.2305	560.2	455.2	33.29
49.4	1.41883	1.2311	561.6	456.2	33.38
49.5	1.41904	1.2316	563.0	457.1	33.46
49.6	1.41925	1.2322	564.4	458.0	33.54
49.7	1.41946	1.2328	565.8	458.9	33.63
49.8	1.41967	1.2333	567.2	459.9	33.71
49.9	1.41988	1.2339	568.6	460.8	33.79
50.0	1.42009	1.2345	570.0	461.7	33.88
50.1	1.42030	1.2350	571.4	462.7	33.96
50.2	1.42051	1.2356	572.8	463.6	34.04
50.3	1.42072	1.2362	574.2	464.5	34.12
50.4	1.42093	1.2368	575.6	465.4	34.21
50.5	1.42114	1.2373	577.1	466.4	34.30
50.6	1.42135	1.2379	578.5	467.3	34.38
50.7	1.42156	1.2385	579.9	468.2	34.46
50.8	1.42177	1.2390	581.3	469.2	34.55
50.9	1.42199	1.2396	582.7	470.1	34.63
51.0	1.42220	1.2402	584.2	471.0	34.72

COMPENDIUM OF INTERNATIONAL ANALYSIS OF METHODS - OIV
Soluble solids in grape juice, reconstituted grape juice,
concentrated grape juice, and grape nectar

Saccharose (%/m/m)	Refractive Index at 20 °C	Mass Density at 20 °C	Sugars (g/L)	Sugars (g/kg)	ABV (% v/v) at 20 °C
51.1	1.42241	1.2408	585.6	471.9	34.80
51.2	1.42262	1.2413	587.0	472.9	34.89
51.3	1.42283	1.2419	588.4	473.8	34.97
51.4	1.42305	1.2425	589.9	474.7	35.06
51.5	1.42326	1.2431	591.3	475.7	35.14
51.6	1.42347	1.2436	592.7	476.6	35.22
51.7	1.42368	1.2442	594.1	477.5	35.31
51.8	1.42390	1.2448	595.6	478.4	35.40
51.9	1.42411	1.2454	597.0	479.4	35.48
52.0	1.42432	1.2460	598.4	480.3	35.56
52.1	1.42454	1.2465	599.9	481.2	35.65
52.2	1.42475	1.2471	601.3	482.1	35.74
52.3	1.42496	1.2477	602.7	483.1	35.82
52.4	1.42518	1.2483	604.2	484.0	35.91
52.5	1.42539	1.2488	605.6	484.9	35.99
52.6	1.42561	1.2494	607.0	485.8	36.07
52.7	1.42582	1.2500	608.5	486.8	36.16
52.8	1.42604	1.2506	609.9	487.7	36.25
52.9	1.42625	1.2512	611.4	488.6	36.34
53.0	1.42647	1.2518	612.8	489.5	36.42
53.1	1.42668	1.2523	614.2	490.5	36.50
53.2	1.42690	1.2529	615.7	491.4	36.59
53.3	1.42711	1.2535	617.1	492.3	36.67
53.4	1.42733	1.2541	618.6	493.2	36.76
53.5	1.42754	1.2547	620.0	494.2	36.85
53.6	1.42776	1.2553	621.5	495.1	36.94
53.7	1.42798	1.2558	622.9	496.0	37.02
53.8	1.42819	1.2564	624.4	496.9	37.11
53.9	1.42841	1.2570	625.8	497.9	37.19
54.0	1.42863	1.2576	627.3	498.8	37.28
54.1	1.42884	1.2582	628.7	499.7	37.36
54.2	1.42906	1.2588	630.2	500.6	37.45
54.3	1.42928	1.2594	631.7	501.6	37.54
54.4	1.42949	1.2600	633.1	502.5	37.63
54.5	1.42971	1.2606	634.6	503.4	37.71
54.6	1.42993	1.2611	636.0	504.3	37.80
54.7	1.43015	1.2617	637.5	505.2	37.89
54.8	1.43036	1.2623	639.0	506.2	37.98
54.9	1.43058	1.2629	640.4	507.1	38.06

COMPENDIUM OF INTERNATIONAL ANALYSIS OF METHODS - OIV
Soluble solids in grape juice, reconstituted grape juice,
concentrated grape juice, and grape nectar

Saccharose (%(m/m))	Refractive Index at 20 °C	Mass Density at 20 °C	Sugars (g/L)	Sugars (g/kg)	ABV (% v/v) at 20 °C
55.0	1.43080	1.2635	641.9	508.0	38.15
55.1	1.43102	1.2641	643.4	508.9	38.24
55.2	1.43124	1.2647	644.8	509.9	38.32
55.3	1.43146	1.2653	646.3	510.8	38.41
55.4	1.43168	1.2659	647.8	511.7	38.50
55.5	1.43189	1.2665	649.2	512.6	38.58
55.6	1.43211	1.2671	650.7	513.5	38.67
55.7	1.43233	1.2677	652.2	514.5	38.76
55.8	1.43255	1.2683	653.7	515.4	38.85
55.9	1.43277	1.2689	655.1	516.3	38.93
56.0	1.43299	1.2695	656.6	517.2	39.02
56.1	1.43321	1.2701	658.1	518.1	39.11
56.2	1.43343	1.2706	659.6	519.1	39.20
56.3	1.43365	1.2712	661.0	520.0	39.28
56.4	1.43387	1.2718	662.5	520.9	39.37
56.5	1.43410	1.2724	664.0	521.8	39.46
56.6	1.43432	1.2730	665.5	522.7	39.55
56.7	1.43454	1.2736	667.0	523.7	39.64
56.8	1.43476	1.2742	668.5	524.6	39.73
56.9	1.43498	1.2748	669.9	525.5	39.81
57.0	1.43520	1.2754	671.4	526.4	39.90
57.1	1.43542	1.2760	672.9	527.3	39.99
57.2	1.43565	1.2766	674.4	528.3	40.08
57.3	1.43587	1.2773	675.9	529.2	40.17
57.4	1.43609	1.2779	677.4	530.1	40.26
57.5	1.43631	1.2785	678.9	531.0	40.35
57.6	1.43653	1.2791	680.4	531.9	40.44
57.7	1.43676	1.2797	681.9	532.8	40.53
57.8	1.43698	1.2803	683.4	533.8	40.61
57.9	1.43720	1.2809	684.9	534.7	40.70
58.0	1.43743	1.2815	686.4	535.6	40.79
58.1	1.43765	1.2821	687.9	536.5	40.88
58.2	1.43787	1.2827	689.4	537.4	40.97
58.3	1.43810	1.2833	690.9	538.3	41.06
58.4	1.43832	1.2839	692.4	539.3	41.15
58.5	1.43855	1.2845	693.9	540.2	41.24
58.6	1.43877	1.2851	695.4	541.1	41.33
58.7	1.43899	1.2857	696.9	542.0	41.42
58.8	1.43922	1.2863	698.4	542.9	41.51

COMPENDIUM OF INTERNATIONAL ANALYSIS OF METHODS - OIV
Soluble solids in grape juice, reconstituted grape juice,
concentrated grape juice, and grape nectar

Saccharose (%(m/m))	Refractive Index at 20 °C	Mass Density at 20 °C	Sugars (g/L)	Sugars (g/kg)	ABV (% v/v) at 20 °C
58.9	1.43944	1.2870	699.9	543.8	41.60
59.0	1.43967	1.2876	701.4	544.8	41.68
59.1	1.43989	1.2882	702.9	545.7	41.77
59.2	1.44012	1.2888	704.4	546.6	41.86
59.3	1.44035	1.2894	706.0	547.5	41.96
59.4	1.44057	1.2900	707.5	548.4	42.05
59.5	1.44080	1.2906	709.0	549.3	42.14
59.6	1.44102	1.2912	710.5	550.2	42.23
59.7	1.44125	1.2919	712.0	551.1	42.31
59.8	1.44148	1.2925	713.5	552.1	42.40
59.9	1.44170	1.2931	715.1	553.0	42.50
60.0	1.44193	1.2937	716.6	553.9	42.59
60.1	1.44216	1.2943	718.1	554.8	42.68
60.2	1.44238	1.2949	719.6	555.7	42.77
60.3	1.44261	1.2956	721.1	556.6	42.85
60.4	1.44284	1.2962	722.7	557.5	42.95
60.5	1.44306	1.2968	724.2	558.4	43.04
60.6	1.44329	1.2974	725.7	559.4	43.13
60.7	1.44352	1.2980	727.3	560.3	43.22
60.8	1.44375	1.2986	728.8	561.2	43.31
60.9	1.44398	1.2993	730.3	562.1	43.40
61.0	1.44420	1.2999	731.8	563.0	43.49
61.1	1.44443	1.3005	733.4	563.9	43.59
61.2	1.44466	1.3011	734.9	564.8	43.68
61.3	1.44489	1.3017	736.4	565.7	43.76
61.4	1.44512	1.3024	738.0	566.6	43.86
61.5	1.44535	1.3030	739.5	567.6	43.95
61.6	1.44558	1.3036	741.1	568.5	44.04
61.7	1.44581	1.3042	742.6	569.4	44.13
61.8	1.44604	1.3049	744.1	570.3	44.22
61.9	1.44627	1.3055	745.7	571.2	44.32
62.0	1.44650	1.3061	747.2	572.1	44.41
62.1	1.44673	1.3067	748.8	573.0	44.50
62.2	1.44696	1.3074	750.3	573.9	44.59
62.3	1.44719	1.3080	751.9	574.8	44.69
62.4	1.44742	1.3086	753.4	575.7	44.77
62.5	1.44765	1.3092	755.0	576.6	44.87
62.6	1.44788	1.3099	756.5	577.5	44.96
62.7	1.44811	1.3105	758.1	578.5	45.05

COMPENDIUM OF INTERNATIONAL ANALYSIS OF METHODS - OIV
Soluble solids in grape juice, reconstituted grape juice,
concentrated grape juice, and grape nectar

Saccharose (%(m/m))	Refractive Index at 20 °C	Mass Density at 20 °C	Sugars (g/L)	Sugars (g/kg)	ABV (% v/v) at 20 °C
62.8	1.44834	1.3111	759.6	579.4	45.14
62.9	1.44858	1.3118	761.2	580.3	45.24
63.0	1.44881	1.3124	762.7	581.2	45.33
63.1	1.44904	1.3130	764.3	582.1	45.42
63.2	1.44927	1.3137	765.8	583.0	45.51
63.3	1.44950	1.3143	767.4	583.9	45.61
63.4	1.44974	1.3149	769.0	584.8	45.70
63.5	1.44997	1.3155	770.5	585.7	45.79
63.6	1.45020	1.3162	772.1	586.6	45.89
63.7	1.45043	1.3168	773.6	587.5	45.98
63.8	1.45067	1.3174	775.2	588.4	46.07
63.9	1.45090	1.3181	776.8	589.3	46.17
64.0	1.45113	1.3187	778.3	590.2	46.25
64.1	1.45137	1.3193	779.9	591.1	46.35
64.2	1.45160	1.3200	781.5	592.0	46.44
64.3	1.45184	1.3206	783.0	592.9	46.53
64.4	1.45207	1.3213	784.6	593.8	46.63
64.5	1.45230	1.3219	786.2	594.7	46.72
64.6	1.45254	1.3225	787.8	595.6	46.82
64.7	1.45277	1.3232	789.3	596.5	46.91
64.8	1.45301	1.3238	790.9	597.4	47.00
64.9	1.45324	1.3244	792.5	598.3	47.10
65.0	1.45348	1.3251	794.1	599.3	47.19
65.1	1.45371	1.3257	795.6	600.2	47.28
65.2	1.45395	1.3264	797.2	601.1	47.38
65.3	1.45418	1.3270	798.8	602.0	47.47
65.4	1.45442	1.3276	800.4	602.9	47.57
65.5	1.45466	1.3283	802.0	603.8	47.66
65.6	1.45489	1.3289	803.6	604.7	47.76
65.7	1.45513	1.3296	805.1	605.6	47.85
65.8	1.45537	1.3302	806.7	606.5	47.94
65.9	1.45560	1.3309	808.3	607.4	48.04
66.0	1.45584	1.3315	809.9	608.3	48.13
66.1	1.45608	1.3322	811.5	609.2	48.23
66.2	1.45631	1.3328	813.1	610.1	48.32
66.3	1.45655	1.3334	814.7	611.0	48.42
66.4	1.45679	1.3341	816.3	611.9	48.51
66.5	1.45703	1.3347	817.9	612.8	48.61
66.6	1.45726	1.3354	819.5	613.7	48.70

COMPENDIUM OF INTERNATIONAL ANALYSIS OF METHODS - OIV
Soluble solids in grape juice, reconstituted grape juice,
concentrated grape juice, and grape nectar

Saccharose (%(m/m))	Refractive Index at 20 °C	Mass Density at 20 °C	Sugars (g/L)	Sugars (g/kg)	ABV (% v/v) at 20 °C
66.7	1.45750	1.3360	821.1	614.6	48.80
66.8	1.45774	1.3367	822.7	615.5	48.89
66.9	1.45798	1.3373	824.3	616.3	48.99
67.0	1.45822	1.3380	825.9	617.2	49.08
67.1	1.45846	1.3386	827.5	618.1	49.18
67.2	1.45870	1.3393	829.1	619.0	49.27
67.3	1.45893	1.3399	830.7	619.9	49.37
67.4	1.45917	1.3406	832.3	620.8	49.46
67.5	1.45941	1.3412	833.9	621.7	49.56
67.6	1.45965	1.3419	835.5	622.6	49.65
67.7	1.45989	1.3425	837.1	623.5	49.75
67.8	1.46013	1.3432	838.7	624.4	49.84
67.9	1.46037	1.3438	840.3	625.3	49.94
68.0	1.46061	1.3445	841.9	626.2	50.03
68.1	1.46085	1.3451	843.6	627.1	50.14
68.2	1.46109	1.3458	845.2	628.0	50.23
68.3	1.46134	1.3464	846.8	628.9	50.33
68.4	1.46158	1.3471	848.4	629.8	50.42
68.5	1.46182	1.3478	850.0	630.7	50.52
68.6	1.46206	1.3484	851.6	631.6	50.61
68.7	1.46230	1.3491	853.3	632.5	50.71
68.8	1.46254	1.3497	854.9	633.4	50.81
68.9	1.46278	1.3504	856.5	634.3	50.90
69.0	1.46303	1.3510	858.1	635.2	51.00
69.1	1.46327	1.3517	859.8	636.1	51.10
69.2	1.46351	1.3524	861.4	636.9	51.19
69.3	1.46375	1.3530	863.0	637.8	51.29

7. Expression of results

The results are expressed as a percentage by mass of saccharose m/m (degrees Brix) to two decimal based on the average of two determinations. In the case of the concentrated grape juice multiply the result by the dilution factor (F = 2.5).

8. Indicative characteristics of the method

A validation study was carried out for the purpose of assessing the suitability of the method for the matrix grape juice, taking into account linearity, limits of detection

COMPENDIUM OF INTERNATIONAL ANALYSIS OF METHODS - OIV
Soluble solids in grape juice, reconstituted grape juice,
concentrated grape juice, and grape nectar

and quantification and the accuracy of the method. The latter parameter was determined by defining the levels of precision and trueness of the method.

8.1. Linearity of the method

Based on the results obtained from the linear regression analysis, the method proved to be linear within the ranges 10.0 °Bx to 69.2 °Bx shown in the Table III.

8.2. Limit of detection and limit of quantification

The detection limit (LD) and limit of quantification (LoQ) were calculated from a grape juice diluted and analyzed and is equal to 3 standard deviations for the LD and 10 standard deviations for the LoQ (Table III).

8.3. Precision of the method

The parameters taken into account were repeatability and reproducibility. Table III shows the values of these parameters. The repeatability was expressed as standard deviation of repeatability (Sr) of 7 measurements for the following °Brix concentrations: 15.9 °Bx; 69.2 °Bx.

The intermediate precision (IP) was expressed as the Standard Deviation (SIP) of measurements of the same grape juice sample, made by different operators.

Table III- Characteristics of the method

Linearity range (°Bx)	Correlation coefficient (r ²)	LD (°Bx)	LoQ (°Bx)	Repeatability Standard Deviation • (n = 7) • S _r	Intermediate Precision (IP) Standard Deviation • (n = 14) • S _{IP}
10.0 – 69.2	0.9999	0.5	1.7	0.03 °Bx	0.04 °Bx

9. Bibliography

1. OIV. Compendium of International Methods of Analysis of Wines and Musts. Method OIV-MA-AS2-02.
2. BS EN ISO 3696, Water for Analytical Laboratory Use — Specification and Test Methods, 1995.

(All Rights Reserved) According to the law, the OIV declines all responsibility for involuntary errors or omissions that might occur, despite care taken in the editing. Reproduction of texts published in this work is forbidden. These texts are the property of OIV, which has the exclusive right to reproduce and translate these texts throughout the world. The law forbids copies and reproductions for group usage. Any representation or reproduction, whether complete or partial, by any means, without the accord of the OIV, is an unlawful act and constitutes an infringement of copyright.

© OIV - 2024

INTERNATIONAL ORGANISATION OF VINE AND WINE

12, Parvis de l'UNESCO

21000 Dijon

Tél. (33) 01.44.94.80.80 - Tlc. (33) 01.42.66.90.63

E-mail: oiv@oiv.int - www.oiv.int